

Toxicological Profile for Perfluoroalkyls

Draft for Public Comment

June 2018



U.S. Department of Health and Human Services
Agency for Toxic Substances and Disease Registry

FOREWORD

This toxicological profile is prepared in accordance with guidelines developed by the Agency for Toxic Substances and Disease Registry (ATSDR) and the Environmental Protection Agency (EPA). The original guidelines were published in the *Federal Register* on April 17, 1987. Each profile will be revised and republished as necessary.

The ATSDR toxicological profile succinctly characterizes the toxicologic and adverse health effects information for these toxic substances described therein. Each peer-reviewed profile identifies and reviews the key literature that describes a substance's toxicologic properties. Other pertinent literature is also presented, but is described in less detail than the key studies. The profile is not intended to be an exhaustive document; however, more comprehensive sources of specialty information are referenced.

The focus of the profiles is on health and toxicologic information; therefore, each toxicological profile begins with a relevance to public health discussion which would allow a public health professional to make a real-time determination of whether the presence of a particular substance in the environment poses a potential threat to human health. The adequacy of information to determine a substance's health effects is described in a health effects summary. Data needs that are of significance to the protection of public health are identified by ATSDR and EPA.

Each profile includes the following:

- (A) The examination, summary, and interpretation of available toxicologic information and epidemiologic evaluations on a toxic substance to ascertain the levels of significant human exposure for the substance and the associated acute, intermediate, and chronic health effects;
- (B) A determination of whether adequate information on the health effects of each substance is available or in the process of development to determine the levels of exposure that present a significant risk to human health due to acute, intermediate, and chronic duration exposures; and
- (C) Where appropriate, identification of toxicologic testing needed to identify the types or levels of exposure that may present significant risk of adverse health effects in humans.

The principal audiences for the toxicological profiles are health professionals at the Federal, State, and local levels; interested private sector organizations and groups; and members of the public. ATSDR plans to revise these documents in response to public comments and as additional data become available. Therefore, we encourage comments that will make the toxicological profile series of the greatest use.

Electronic comments may be submitted via: www.regulations.gov. Follow the on-line instructions for submitting comments.

Written comments may also be sent to: Agency for Toxic Substances and Disease Registry
Division of Toxicology and Human Health Sciences
Environmental Toxicology Branch

Regular Mailing Address:
1600 Clifton Road, N.E.
Mail Stop F-57
Atlanta, Georgia 30329-4027

Physical Mailing Address:
4770 Buford Highway
Building 102, 1st floor, MS F-57
Chamblee, Georgia 30341

The toxicological profiles are developed under the Comprehensive Environmental Response, Compensation, and Liability Act of 1980, as amended (CERCLA or Superfund). CERCLA section 104(i)(1) directs the Administrator of ATSDR to "...effectuate and implement the health related authorities" of the statute. This includes the preparation of toxicological profiles for hazardous substances most commonly found at facilities on the CERCLA National Priorities List (NPL) and that pose the most significant potential threat to human health, as determined by ATSDR and the EPA. Section 104(i)(3) of CERCLA, as amended, directs the Administrator of ATSDR to prepare a toxicological profile for each substance on the list. In addition, ATSDR has the authority to prepare toxicological profiles for substances not found at sites on the NPL, in an effort to "...establish and maintain inventory of literature, research, and studies on the health effects of toxic substances" under CERCLA Section 104(i)(1)(B), to respond to requests for consultation under section 104(i)(4), and as otherwise necessary to support the site-specific response actions conducted by ATSDR.

This profile reflects ATSDR's assessment of all relevant toxicologic testing and information that has been peer-reviewed. Staffs of the Centers for Disease Control and Prevention and other Federal scientists have also reviewed the profile. In addition, this profile has been peer-reviewed by a nongovernmental panel and is being made available for public review. Final responsibility for the contents and views expressed in this toxicological profile resides with ATSDR.



Patrick N. Breysse, Ph.D., CIH
Director, National Center for Environmental Health and
Agency for Toxic Substances and Disease Registry
Centers for Disease Control and Prevention

VERSION HISTORY

Date	Description
June 2018	Draft for public comment toxicological profile released
August 2015	Draft for public comment toxicological profile released
May 2009	Draft for public comment toxicological profile released

CONTRIBUTORS & REVIEWERS

CHEMICAL MANAGER TEAM

Selene Chou, Ph.D. (Lead)
Dennis Jones, DVM, Ph.D.
Hana R. Pohl, M.D., Ph.D.
Patricia Ruiz, Ph.D.
Franco Scinicariello, M.D., M.P.H.
Melanie Buser, M.P.H.

Lisa Ingerman, Ph.D., DABT
Lynn Barber, M.S.
Heather Carlson-Lynch, M.S., DABT
Mario Citra, Ph.D.
Gary L. Diamond, Ph.D.
Julie Klotzbach, Ph.D.
Fernando T. Lladós, Ph.D.
Daniel J. Plewak, B.S.

ATSDR, Division of Toxicology and Human Health
Sciences, Atlanta, GA

SRC, Inc., North Syracuse, NY

REVIEWERS

Interagency Minimal Risk Level Workgroup:

Includes ATSDR; National Center for Environmental Health (NCEH); National Institute of Occupational Health and Safety (NIOSH); U.S. Environmental Protection Agency (EPA); National Toxicology Program (NTP).

Additional reviews for science and/or policy:

ATSDR, Division of Community Health Investigations; EPA; NCEH, Division of Laboratory Science.

PEER REVIEWERS

1. David A. Savitz, Ph.D., Professor of Epidemiology, Professor of Obstetrics and Gynecology, Brown University, Providence, Rhode Island
2. Deborah A. Cory-Slechta, Ph.D., Professor of Environmental Medicine, Pediatrics and Public Health Sciences, Acting Chair, Department of Environmental Medicine, PI, NIEHS Center of Excellence, Department of Environmental Medicine, University of Rochester Medical Center, Rochester, New York
3. Jamie DeWitt, Ph.D., Associate Professor, Department of Pharmacology & Toxicology, Brody School of Medicine, East Carolina University, Greenville, North Carolina
4. Edward Emmett, M.D., Professor, Center of Excellence in Environmental Toxicology, University of Pennsylvania, Philadelphia, Pennsylvania

These experts collectively have knowledge of toxicology, chemistry, and/or health effects. All reviewers were selected in conformity with Section 104(I)(13) of the Comprehensive Environmental Response, Compensation, and Liability Act, as amended.

ATSDR scientists review peer reviewers' comments and determine whether changes will be made to the profile based on comments. The peer reviewers' comments and responses to these comments are part of the administrative record for this compound.

The listing of peer reviewers should not be understood to imply their approval of the profile's final content. The responsibility for the content of this profile lies with ATSDR.

CONTENTS

FOREWORD	ii
VERSION HISTORY	iv
CONTRIBUTORS & REVIEWERS	v
CONTENTS.....	vi
LIST OF FIGURES	ix
LIST OF TABLES	xii
CHAPTER 1. RELEVANCE TO PUBLIC HEALTH	1
1.1 OVERVIEW AND U.S. EXPOSURES	1
1.2 SUMMARY OF HEALTH EFFECTS	4
1.3 MINIMAL RISK LEVELS (MRLs)	15
CHAPTER 2. HEALTH EFFECTS.....	21
2.1 INTRODUCTION.....	21
2.2 DEATH	106
2.3 BODY WEIGHT	109
2.4 RESPIRATORY	121
2.5 CARDIOVASCULAR	123
2.6 GASTROINTESTINAL.....	135
2.7 HEMATOLOGICAL	137
2.8 MUSCULOSKELETAL	141
2.9 HEPATIC	146
2.10 RENAL.....	202
2.11 DERMAL	219
2.12 OCULAR.....	220
2.13 ENDOCRINE.....	221
2.14 IMMUNOLOGICAL	244
2.15 NEUROLOGICAL.....	293
2.16 REPRODUCTIVE.....	300
2.17 DEVELOPMENTAL	340
2.18 OTHER NONCANCER	406
2.19 CANCER.....	418
2.20 MECHANISM OF TOXICITY	433
2.20.1 Cellular Mechanisms of Toxicity	434
2.20.2 Hepatic Toxicity Mechanisms.....	441
2.20.3 Developmental Toxicity Mechanisms.....	443
2.20.4 Immunotoxicity Mechanisms	444
2.20.5 Endocrine Mechanisms	445
2.20.6 Cancer Mechanisms	446
2.21 GENOTOXICITY	447
CHAPTER 3. TOXICOKINETICS, SUSCEPTIBLE POPULATIONS, BIOMARKERS, CHEMICAL INTERACTIONS	450
3.1 TOXICOKINETICS.....	450
3.1.1 Absorption.....	451
3.1.2 Distribution	455
3.1.3 Metabolism.....	469
3.1.4 Excretion	469

3.1.5	Physiologically Based Pharmacokinetic (PBPK)/Pharmacodynamic (PD) Models	493
3.1.5.1	Loccisano et al. (2012a, 2012b) Rat Models	494
3.1.5.2	Loccisano et al. (2011, 2013) Monkey and Human Models	500
3.1.5.3	Rodriguez et al. (2009) Mouse Model	504
3.1.5.4	Wambaugh et al. 2013 (Andersen et al. 2006) Model	506
3.1.5.5	Harris and Barton (2008) Rat Model	509
3.1.5.6	Worley and Fisher (2015a, 2015b) Rat Model	512
3.1.5.7	Worley et al. (2017b) Human Model	513
3.1.5.8	Fàbrega et al. (2014, 2016) Human Model	513
3.1.6	Animal-to-Human Extrapolations	514
3.2	CHILDREN AND OTHER POPULATIONS THAT ARE UNUSUALLY SUSCEPTIBLE ..	515
3.3	BIOMARKERS OF EXPOSURE AND EFFECT	518
3.3.1	Biomarkers of Exposure	519
3.3.2	Biomarkers of Effect	520
3.4	INTERACTIONS WITH OTHER CHEMICALS	520
CHAPTER 4. CHEMICAL AND PHYSICAL INFORMATION		521
4.1	CHEMICAL IDENTITY	521
4.2	PHYSICAL AND CHEMICAL PROPERTIES	521
CHAPTER 5. POTENTIAL FOR HUMAN EXPOSURE		533
5.1	OVERVIEW	533
5.2	PRODUCTION, IMPORT/EXPORT, USE, AND DISPOSAL	537
5.2.1	Production	537
5.2.2	Import/Export	545
5.2.3	Use	545
5.2.4	Disposal	546
5.3	RELEASES TO THE ENVIRONMENT	546
5.3.1	Air	551
5.3.2	Water	552
5.3.3	Soil	554
5.4	ENVIRONMENTAL FATE	555
5.4.1	Transport and Partitioning	555
5.4.2	Transformation and Degradation	559
5.5	LEVELS IN THE ENVIRONMENT	561
5.5.1	Air	564
5.5.2	Water	571
5.5.3	Sediment and Soil	582
5.5.4	Other Media	587
5.6	GENERAL POPULATION EXPOSURE	596
5.7	POPULATIONS WITH POTENTIALLY HIGH EXPOSURES	623
CHAPTER 6. ADEQUACY OF THE DATABASE		628
6.1	Existing Information on Health Effects	628
6.2	Identification of Data Needs	632
6.3	Ongoing Studies	642
CHAPTER 7. REGULATIONS AND GUIDELINES		644
CHAPTER 8. REFERENCES		647

APPENDICES

APPENDIX A. ATSDR MINIMAL RISK LEVELS AND WORKSHEETS.....	A-1
APPENDIX B. LITERATURE SEARCH FRAMEWORK FOR PERFLUOROALKYLS	B-1
APPENDIX C. USER'S GUIDE	C-1
APPENDIX D. QUICK REFERENCE FOR HEALTH CARE PROVIDERS	D-1
APPENDIX E. GLOSSARY	E-1
APPENDIX F. ACRONYMS, ABBREVIATIONS, AND SYMBOLS	F-1

LIST OF FIGURES

1-1. Health Effects Found in Animals Following Oral Exposure to PFOA.....	7
1-2. Health Effects Found in Animals Following Oral Exposure to PFOS	8
1-3. Health Effects Found in Animals Following Oral Exposure to Other Perfluoroalkyls	9
1-4. Summary of Sensitive Targets of PFOA – Oral	17
1-5. Summary of Sensitive Targets of PFOS – Oral.....	18
2-1. Overview of the Number of Studies Examining PFOA Health Effects.....	27
2-2. Overview of the Number of Studies Examining PFOS Health Effects	28
2-3. Overview of the Number of Studies Examining Other Perfluoroalkyls Health Effects	29
2-4. Levels of Significant Exposure to PFOA – Inhalation	32
2-5. Levels of Significant Exposure to Other Perfluoroalkyls – Inhalation.....	34
2-6. Levels of Significant Exposure to PFOA – Oral	58
2-7. Levels of Significant Exposure to PFOS – Oral.....	81
2-8. Levels of Significant Exposure to Other Perfluoroalkyls – Oral.....	99
2-9. Serum Total Cholesterol Levels Relative to Serum PFOA Levels.....	173
2-10. Risk of Abnormal Cholesterol Levels Relative to PFOA Levels (Presented as Adjusted Ratios)	174
2-11. Serum LDL Cholesterol Levels Relative to Serum PFOA Levels	175
2-12. Risk of Abnormal LDL Cholesterol Levels Relative to PFOA Levels (Presented as Adjusted Ratios).....	176
2-13. Serum Total Cholesterol Levels Relative to Serum PFOS Levels	189
2-14. Risk of Abnormal Cholesterol Levels Relative to PFOS Levels (Presented as Adjusted Ratios)	190
2-15. Serum LDL Cholesterol Levels Relative to Serum PFOS Levels	191
2-16. Risk of Abnormal LDL Cholesterol Levels Relative to PFOS Levels (Presented as Adjusted Ratios).....	192
2-17. Risk of Hyperuricemia Relative to PFOA Levels (Presented as Adjusted Odds Ratios).....	213
2-18. Risk of Hyperuricemia Relative to PFOS Levels (Presented as Adjusted Odds Ratios).....	215

2-19. Antibody Responses Relative to Serum PFOA Levels in Epidemiology Studies	270
2-20. Risk of Asthma Diagnosis Relative to PFOA Levels (Presented as Adjusted Odds Ratios).....	272
2-21. Antibody Responses Relative to Serum PFOS Levels in Epidemiology Studies	278
2-22. Risk of Asthma Diagnosis Relative to PFOS Levels (Presented as Adjusted Odds Ratios)	280
2-23. Antibody Responses Relative to Serum PFHxS Levels in Epidemiology Studies	283
2-24. Risk of Asthma Diagnosis Relative to PFHxS Levels (Presented as Adjusted Odds Ratios)	285
2-25. Antibody Responses Relative to Serum PFNA Levels in Epidemiology Studies	287
2-26. Risk of Asthma Diagnosis Relative to PFNA Levels (Presented as Adjusted Odds Ratios).....	288
2-27. Antibody Responses Relative to Serum PFDeA Levels in Epidemiology Studies	290
2-28. Risk of Asthma Diagnosis Relative to PFDeA Levels (Presented as Adjusted Odds Ratios).....	292
2-29. Fecundability Relative to PFOA Levels (Presented as Adjusted Fecundability Ratios)	326
2-30. Infertility Relative to PFOA Levels (Presented as Adjusted Odds Ratios)	327
2-31. Fecundability Relative to PFOS Levels (Presented as Adjusted Fecundability Ratios).....	333
2-32. Infertility Relative to PFOS Levels (Presented as Adjusted Odds Ratios).....	334
2-33. Risk of Low Birth Weight Infant Relative to PFOA Levels (Presented as Adjusted Odds Ratios)	379
2-34. Risk of Small For Gestational Age Infant Relative to PFOA Levels (Presented as Adjusted Odds Ratios)	380
2-35. Risk of Low Birth Weight Infant Relative to PFOS Levels (Presented as Adjusted Odds Ratios)	391
2-36. Risk of Small for Gestational Age Infant Relative to PFOS Levels (Presented as Adjusted Odds Ratios)	392
2-37. Diabetes Risk Relative to Serum PFOA Levels (Presented as Adjusted Ratios)	415
2-38. Diabetes Risk Relative to Serum PFOS Levels (Presented as Adjusted Odds Ratios).....	417
3-1. Tissue Concentrations of ¹⁴ C in Male and Female Rats Following a Single Gavage Dose of [¹⁴ C]PFOA at 1, 5, or 25 mg/kg.....	458
3-2. Tissue Concentrations of ¹⁴ C in Male (Upper Panel) and Female (Lower Panel) Rats Following Oral Doses of PFOA for 28 Days at Doses of 3, 10, or 30 mg/kg/day	459

3-3. Structure of PBPK Model of PFOA and PFOS in the Rat.....	495
3-4. PBPK Model Structure for Simulating PFOA and PFOS Exposure During Gestation in the Rat (Dam, Left; Fetus, Right).....	496
3-5. PBPK Model Structure for Simulating PFOA/PFOS Exposure During Lactation in the Rat (Dam, Left; Pup, Right).....	497
3-6. Structure of PBPK Model for PFOA and PFOS in Monkeys and Humans.....	501
3-7. Renal Resorption Pharmacokinetic Model of Gestation and Lactation used in the Analysis of CD-1 Mice	505
3-8. Andersen et al. (2006) Pharmacokinetic Model with Oral Absorption	507
3-9. Conceptual Representation of a Physiologically Based Pharmacokinetic Model for PFOS Exposure in Rats.....	510
5-1. Number of NPL Sites with Perfluoroalkyls Contamination	533
5-2. Timeline of Important Events in the History of Polyfluorinated Compounds.....	539
6-1. Summary of Existing Health Effects Studies on PFOA By Route and Endpoint.....	629
6-2. Summary of Existing Health Effects Studies on PFOS By Route and Endpoint	630
6-3. Summary of Existing Health Effects Studies on Other Perfluoroalkyls By Route and Endpoint	631

LIST OF TABLES

1-1. Summary of Estimated Elimination Half-lives for Select Perfluoroalkyls.....	4
1-2. Overview of Provisional Minimal Risk Levels Derived for Perfluoroalkyl Compounds.....	15
1-3. Provisional Minimal Risk Levels (MRLs) for PFOA.....	19
1-4. Provisional Minimal Risk Levels (MRLs) for PFOS	19
1-5. Provisional Minimal Risk Levels (MRLs) for PFHxS	20
1-6. Provisional Minimal Risk Levels (MRLs) for PFNA.....	20
2-1. Levels of Significant Exposure to PFOA – Inhalation	30
2-2. Levels of Significant Exposure to Other Perfluoroalkyls – Inhalation.....	33
2-3. Levels of Significant Exposure to PFOA – Oral	35
2-4. Levels of Significant Exposure to PFOS – Oral	62
2-5. Levels of Significant Exposure to Other Perfluoroalkyls – Oral.....	85
2-6. Levels of Significant Exposure to PFOA – Dermal	104
2-7. Summary of Childhood Growth in Humans	110
2-8. Summary of Cardiovascular Outcomes in Humans.....	125
2-9. Summary of Skeletal Outcomes in Humans	142
2-10. Summary of Liver Disease in Humans	148
2-11. Summary of Alterations in Serum Hepatic Enzymes and Bilirubin Levels in Humans	150
2-12. Summary of Serum Lipid Outcomes in Humans.....	156
2-13. Summary of Renal Outcomes in Humans.....	203
2-14. Summary of Uric Acid Outcomes in Humans	206
2-15. Summary of Thyroid Outcomes in Humans	223
2-16. Summary of Immunological Outcomes in Humans	245
2-17. Summary of Neurological Outcomes in Humans	294
2-18. Summary of Alterations in Reproductive Hormone Levels in Humans	301
2-19. Summary of Male Reproductive Outcomes in Humans	308

2-20. Summary of Female Reproductive Outcomes in Humans.....	313
2-21. Summary of Fertility Outcomes in Humans.....	318
2-22. Summary of Pregnancy Outcomes in Humans.....	341
2-23. Summary of Birth Outcomes in Humans.....	344
2-24. Summary of Neurodevelopmental Outcomes in Humans.....	360
2-25. Summary of Effects on the Development of the Reproductive System in Humans.....	371
2-26. Summary of Outcomes Related to Diabetes in Humans.....	407
2-27. Summary of Cancer Outcomes in Humans.....	419
2-28. Transactivation of Human and Mouse PPAR α in Transfected Cos-1 Cells Exposed to Perfluoroalkyl Compounds (In Order of Decreasing C _{20max} in the Mouse).....	436
2-29. Gene Expression Changes Induced by Perfluoroalkyl Compounds.....	439
2-30. Hepatic Effects of Perfluoroalkyl Compounds in Wild-Type and PPAR α -Null Mice Exposed Orally.....	442
3-1. Tissue Distribution and Excretion of ¹⁴ C-Radioactivity from Both Sexes of Rats, Mice, Hamsters, and Rabbits Dosed with ¹⁴ C-Labeled APFO.....	461
3-2. Serum (or Plasma) Concentrations in Matched Human Maternal-Infant Pairs.....	463
3-3. Matched Serum (or Plasma) and Breast Milk Concentrations in Humans.....	467
3-4. Excretory Clearance of PFOA and PFOS in Humans.....	471
3-5. Summary Elimination Half-Lives for Perfluoroalkyls Estimated in Humans and Experimental Animals.....	473
3-6. Summary Systemic Clearance for Perfluoroalkyls Estimated in Experimental Animals.....	481
3-7. Estimated and Assumed Pharmacokinetic Parameters for the Modified Andersen et al. (2006) Model for PFOA and PFOS.....	508
4-1. Chemical Identity of Perfluoroalkyls.....	522
4-2. Physical and Chemical Properties of Perfluoroalkyls.....	527
5-1. Content (ppm) and Percent Reduction of PFOA, PFOA Homologues, or PFOA Precursors in Products from 2006 and 2013 U.S. Operations of Fluoropolymer/Fluorotelomer Companies.....	541
5-2. U.S. Production Volume Ranges for Perfluoroalkyls (1986–2002) Reported under the EPA Inventory Update Rule.....	545

5-3. Reported Emissions of PFOA, PFOA Homologues, or PFOA Precursors in Products from the 2006 and 2013 U.S. Operations of Fluoropolymer/Fluorotelomer Companies.....	547
5-4. Global Historical PFCA Production and Emissions Estimates from 1951 to 2004.....	550
5-5. Biological Monitoring of PFOA and PFOS in the Arctic.....	556
5-6. Lowest Limit of Detection Based on Standards	562
5-7. Summary of Environmental Levels of Perfluoroalkyls	562
5-8. Perfluoroalkyls Levels in Water, Soil, and Air of National Priorities List (NPL) Sites.....	563
5-9. Concentrations of Perfluoroalkyl in Outdoor Air.....	565
5-10. Concentrations of Perfluoroalkyl in Indoor Air.....	568
5-11. Concentration (ng/g) of Perfluoroalkyls in 39 Dust Samples.....	570
5-12. Concentrations of PFOA and PFOS in Surface Water (ng/L).....	572
5-13. Concentrations of Other Perfluoroalkyls in Surface Water	574
5-14. Concentrations of Perfluoroalkyls in Surface Water and Groundwater at Fluorochemical Industrial Facilities	576
5-15. Concentrations of PFOA and PFOS in Ocean Water	578
5-16. Concentrations of Perfluoroalkyls in Soil and Sediment at Fluorochemical Industrial Facilities	583
5-17. Summary of Perfluoroalkyl Compounds Detected in Soil, Sediment, Surface Water, and Groundwater at 10 Military Installations.....	586
5-18. Detections of PFOA in 31 U.S. Food Items	588
5-19. Detections of Perfluoroalkyls in Fish from U.S. Lakes and Rivers.....	589
5-20. Fluorotelomer Alcohols Detected in Microwaveable Popcorn Bags Produced in China and the United States.....	594
5-21. Concentrations of PFOA and PFOS in Human Serum Collected in the United States	597
5-22. Concentrations of Other Perfluoroalkyls in Human Serum Collected in the United States	600
5-23. Concentrations of PFOA, PFOS, and PFHxS in Human Serum for Occupationally Exposed Individuals	608
5-24. Percent Detection and Levels of PFOA and PFOS in Children’s Serum, Umbilical Cord Blood, and Breast Milk.....	611

5-25. Percent Detection and Levels of Other Perfluoroalkyls in Children’s Serum, Umbilical Cord Blood, and Breast Milk.....	616
5-26. Blood Serum Levels for 69,030 Current and Former Residents of Six Water Districts in the Mid-Ohio Valley (2005–2006).....	625
6-1. Ongoing Studies on Perfluoroalkyls	642
7-1. Regulations and Guidelines Applicable to Perfluoroalkyls	644
7-2. Select State Drinking Water and Daily Intake Levels for Perfluoroalkyls	646

CHAPTER 1. RELEVANCE TO PUBLIC HEALTH

This toxicological profile on perfluoroalkyls discusses information on 14 perfluoroalkyl compounds that have been measured in the serum collected from a representative U.S. population 12 years of age and older in the National Health and Nutrition Examination Survey (NHANES) 2003–2004 (Calafat et al. 2007b), as well as 2 compounds (PFBA and PFHxA) that have been identified in other monitoring studies. These compounds include:

- Perfluorobutyric acid (PFBA)
- Perfluorohexanoic acid (PFHxA)
- Perfluoroheptanoic acid (PFHpA)
- Perfluorooctanoic acid (PFOA)
- Perfluorononanoic acid (PFNA)
- Perfluorodecanoic acid (PFDeA)
- Perfluoroundecanoic acid (PFUA)
- Perfluorobutane sulfonic acid (PFBS)
- Perfluorohexane sulfonic acid (PFHxS)
- Perfluorooctane sulfonic acid (PFOS)
- Perfluorododecanoic acid (PFDoA)
- Perfluorooctane sulfonamide (PFOSA)
- 2-(N-Methyl-perfluorooctane sulfonamide) acetic acid (Me-PFOSA-AcOH)
- 2-(N-Ethyl-perfluorooctane sulfonamide) acetic acid (Et-PFOSA-AcOH)

The term “perfluoroalkyls” used throughout the toxicological profile is referring to these 14 compounds and the information may not be applicable to other perfluoroalkyl compounds.

1.1 OVERVIEW AND U.S. EXPOSURES

The perfluoroalkyl compounds discussed in this profile primarily consist of perfluorinated aliphatic carboxylic acids (PFCAs), perfluorinated aliphatic sulfonic acids (PFSAs), and some polyfluorinated substances that may degrade or be metabolized to some important perfluorinated substances such as PFOA or PFOS. These substances have been used extensively in surface coating and protectant formulations due to their unique surfactant properties (Kissa 2001; Schultz et al. 2003). Major applications have included protectants for paper and cardboard packaging products, carpets, leather products, and textiles that enhance water, grease, and soil repellency (3M 1999; Hekster et al. 2003; Kissa 2001; Schultz et al. 2003), and in firefighting foams (Schultz et al. 2003). Perfluoroalkyls such as PFOA have also been used as processing aids in the manufacture of fluoropolymers such as nonstick coatings on cookware (DuPont 2008; EPA 2008a).

1. RELEVANCE TO PUBLIC HEALTH

Perfluoroalkyls are human-made substances that do not occur naturally in the environment. The perfluoroalkyl substances discussed in this profile, especially PFOS and PFOA, have been detected in air, water, and soil in and around fluorochemical facilities; however, these industrial releases have been declining since companies began phasing out the production and use of several perfluoroalkyls in the early 2000s (3M 2007b, 2008a, 2008b; Barton et al. 2007; Davis et al. 2007; DuPont 2008; EPA 2007a, 2008a, 2016a). PFOA and PFOS are no longer manufactured or imported into the United States; however, there could be some imported goods containing trace amounts of these substances as impurities. Information regarding current releases of shorter-chain perfluoroalkyls (perfluorinated carboxylic acids with six or fewer carbons and perfluorosulfonic acids with five or fewer carbons) that are now being used in surface treatment products or perfluoropolyethers that are used as a replacement for PFOA in emulsion polymerization processes has not been located. In the environment, some of the perfluoroalkyls discussed in this profile can also be formed from environmental degradation of precursor compounds released during the manufacture and use of consumer products containing perfluoroalkyls (D'eon and Mabury 2007; D'eon et al. 2009; Martin et al. 2006; Prevedouros et al. 2006). Under the PFOA Stewardship Program with the U.S. Environmental Protection Agency (EPA), eight major fluoropolymer producers have phased out PFOA, precursor substances that can degrade to long-chain perfluoroalkyls such as PFOA, and higher homologues from emissions and products (EPA 2008a, 2016a).

Due to their chemical structure, perfluoroalkyls are very stable in the environment and are resistant to biodegradation, photooxidation, direct photolysis, and hydrolysis (3M 2000; EPA 2008a; OECD 2002, 2007; Schultz et al. 2003). The perfluoroalkyl carboxylic acids and sulfonic acids have very low volatility due to their ionic nature (Kissa 2001; Prevedouros et al. 2006; SPARC 2008). As a group, perfluoroalkyls are persistent in soil and water (3M 2000; Prevedouros et al. 2006). Perfluoroalkyls are mobile in soil and leach into groundwater (Davis et al. 2007). Volatile fluorotelomer alcohols may be broken down into substances like PFOA, and atmospheric deposition can lead to contamination of soils and leaching into groundwater away from point sources. Perfluoroalkyls have been detected in many parts of the world, including oceans and the Arctic, indicating that long-range transport is possible (Armitage et al. 2006; Barber et al. 2007; Prevedouros et al. 2006; Wania 2007; Wei et al. 2007a; Yamashita et al. 2005, 2008).

Perfluoroalkyls have been detected in all environmental media including air, surface water, groundwater (including drinking water), soil, and food. Human exposure may occur from all of these media. Contaminated drinking water led to high levels of exposure to PFOA, PFOS, and other perfluoroalkyls for some populations residing near fluoropolymer manufacturing facilities (ATSDR 2008; Emmett et al.

1. RELEVANCE TO PUBLIC HEALTH

2006a; Steenland et al. 2009b). Median PFOA serum levels of in 45,276 non-occupationally exposed individuals residing in southeastern Ohio and West Virginia who were exposed to PFOA via contaminated drinking water were approximately 6 times greater than the median concentration of the general population when compared to NHANES data (Shin et al. 2011). Serum levels of PFOA and PFOS in the general population of the United States have decreased dramatically in recent years as U.S. production of these substances ceased (CDC 2018). For example, the geometric mean concentrations of PFOA and PFOS in the general population were 5.2 and 30.4 ng/mL (ppb), respectively, in 1999–2000, but have decreased to 1.94 ng/mL (PFOA) and 4.99 ng/mL (PFOS) in 2013–2014 (CDC 2018).

Based on environmental measurements and theoretical models, one study has proposed that the major exposure pathways for PFOS for the general population in Europe and North America are food and water ingestion, dust ingestion, and hand-to-mouth transfer from mill-treated carpets (Trudel et al. 2008). For PFOA, major exposure pathways were proposed to be oral exposure resulting from migration from paper packaging and wrapping into food, general food and water ingestion, inhalation from impregnated clothes, and dust ingestion. This includes exposure to 8:2 fluorotelomer alcohol in food packaging and air, which can be broken down into PFOA. PFOS and PFOA exposure pathways are proposed to be similar for children except that exposure from hand-to-mouth transfer from treated carpets is expected to be much greater in children. Based on these exposure pathways, adult uptake doses estimated for high-exposure scenarios were approximately 30 and 47 ng/kg/day for PFOS and PFOA, respectively (Trudel et al. 2008). PFOS and PFOA doses estimated for children under the age of 12 under high exposure scenarios were 101–219 and 65.2–128 ng/kg/day, respectively. Since PFOA and PFOS are no longer produced or used in the United States, current exposure levels may be lower than those predicted by Trudel et al. (2008). A study by Vestergren and Cousins (2009) evaluated potential exposure to perfluorocarboxylate homologues for different populations and also concluded that dietary intake was the primary background exposure pathway for the general population, while inhalation of indoor air was the main exposure pathway for occupationally exposed individuals with estimated intakes >150 ng/kg/day.

Perfluoroalkyls have been detected in human breast milk and umbilical cord blood. The reported maximum concentrations of PFOS and PFOA measured in human breast milk samples were 0.360–0.639 and 0.210–0.490 ng/mL, respectively (Kärman et al. 2007; So et al. 2006b; Völkel et al. 2008). Maximum concentrations of other perfluoroalkyl compounds were <0.18 ng/mL. In most umbilical cord samples, the concentrations of PFOS and PFOA ranged from 4.9 to 11.0 and from 1.6 to 3.7 ng/mL, respectively (Apelberg et al. 2007a, 2007b; Fei et al. 2007; Inoue et al. 2004; Midasch et al. 2007). Other perfluoroalkyls have been detected less frequently.

1. RELEVANCE TO PUBLIC HEALTH

1.2 SUMMARY OF HEALTH EFFECTS

Perfluoroalkyls are ubiquitous chemicals in the environment; they are readily absorbed following inhalation or oral exposure and are not metabolized in humans or laboratory animals. The toxicity of perfluoroalkyl compounds, particularly PFOA and PFOS, has been extensively evaluated in humans and laboratory animals. However, comparison of the toxicity of perfluoroalkyls across species is problematic due to differences in elimination half-lives, lack of adequate mechanistic data, species differences in the mechanism of toxicity for some endpoints, and differences in measurement of exposure levels between epidemiology and experimental studies. Substantial differences in the rate of elimination of perfluoroalkyls exist across species. Table 1-1 lists half-lives for PFOA, PFOS, PFHxS, PFBuS, and PFBA for human, nonhuman primates, rats, and mice to illustrate some of the species differences. For example, for PFOA, the estimated elimination half-life ranges from 8 years in humans to 1.9 hours in female rats.

Table 1-1. Summary of Estimated Elimination Half-lives for Select Perfluoroalkyls

	Humans	Nonhuman primates	Rats ^a	Mice ^a
PFOA	8 years (Olsen et al. 2007a)	20.1–32.6 days (Butenhoff et al. 2004c)	Males: 44–322 hours Females: 1.9–16.2 hours	
PFOS	5.4 years (Olsen et al. 2007a)	110–170 days (Chang et al. 2012; Seacat et al. 2002)	179–1,968 hours	731–1,027 hours
PFHxS	8.5 years (Olsen et al. 2007a)	87–141 days (Sundström et al. 2012)	Males: 382–688 hours Females: 1.03–41.28 hours	597–643 hours
PFBuS	665 hours (Olsen et al. 2009)	8.0–95.2 hours (Chengelis et al. 2009; Olsen et al. 2009)	2.1–7.42 hours	
PFBA	72 hours (Chang et al. 2008b)	40.3–41.0 hours (Chang et al. 2008b)	1.03–9.22 hours	2.79–13.34 hours

^aSee Section 3.1.4 for citations.

The mechanisms of toxicity of perfluoroalkyl compounds have not been fully elucidated. There is strong evidence that some effects observed in rodents, such as hepatotoxicity, immunotoxicity, and developmental toxicity, involve the activation of peroxisome proliferator-activated receptor- α (PPAR α); however, humans and nonhuman primates are less responsive to PPAR α agonists than rodents. Additionally, PPAR α -independent mechanisms are also involved and it is not known if species

1. RELEVANCE TO PUBLIC HEALTH

differences exist for these mechanisms. In general, epidemiology studies use serum perfluoroalkyl levels as a biomarker of exposure, which contrasts with experimental studies that utilize dose, expressed in mg/kg body weight/day units, or air concentrations as the dose metric. Although physiologically based pharmacokinetic (PBPK) models have been developed for rodents and humans, these models are not sufficient to allow for comparisons between administered doses in laboratory animals and serum concentrations in humans.

Effects in Humans. Perfluoroalkyl compounds have been detected in the serum of workers, residents living near perfluoroalkyl facilities, and the general population. A large number of epidemiology studies have evaluated possible associations between perfluoroalkyl exposure and a wide range of adverse health outcomes. Most of the studies have focused on PFOA and/or PFOS; fewer studies have evaluated a smaller number of potential health outcomes for the remaining 12 perfluoroalkyls included in this toxicological profile. Most of the epidemiology studies lack exposure monitoring data, and there is a potential for multiple routes of exposure (inhalation and oral); however, most of the studies used serum perfluoroalkyl level as a biomarker of exposure. The three primary sources of this information are occupational exposure studies, studies of communities living near a PFOA manufacturing facility with high levels of PFOA in the drinking water, and studies of populations exposed to background levels of perfluoroalkyl compounds (referred to as general population studies). Of the three categories of subjects, workers have the highest potential exposure to perfluoroalkyls, followed by the highly-exposed residents in the Mid-Ohio Valley, and then the general population. In one study of workers at the Washington Works facility in West Virginia, the average serum PFOA level in 2001–2004 was 1,000 ng/mL (Sakr et al. 2007a); the mean PFOA level in highly-exposed residents (without occupational exposure) near this facility was 423 ng/mL in 2004–2005 (Emmett et al. 2006a). By comparison, the geometric mean concentration of PFOA in the U.S. population was 3.92 ng/mL in 2005–2006 (CDC 2013). Although a large number of epidemiology studies have examined the potential of perfluoroalkyl compounds to induce adverse health effects, most of the studies are cross-sectional in design and do not establish causality. Based on a number of factors (described in Section 2.1) including the consistency of findings across studies, the available epidemiology studies suggest associations between perfluoroalkyl exposure and several health outcomes:

- Pregnancy-induced hypertension/pre-eclampsia (PFOA, PFOS)
- Liver damage, as evidenced by increases in serum enzymes and decreases in serum bilirubin levels (PFOA, PFOS, PFHxS)

1. RELEVANCE TO PUBLIC HEALTH

- Increases in serum lipids, particularly total cholesterol and low-density lipoprotein (LDL) cholesterol (PFOA, PFOS, PFNA, PFDeA)
- Increased risk of thyroid disease (PFOA, PFOS)
- Decreased antibody response to vaccines (PFOA, PFOS, PFHxS, PFDeA)
- Increased risk of asthma diagnosis (PFOA)
- Increased risk of decreased fertility (PFOA, PFOS)
- Small (<20 g or 0.7 ounces per 1 ng/mL increase in blood perfluoroalkyl level) decreases in birth weight (PFOA, PFOS)

The International Agency for Research on Cancer (IARC 2017) concluded that PFOA is possibly carcinogenic to humans (Group 2B) and EPA (2016e, 2016f) concluded that there was suggestive evidence of the carcinogenic potential of PFOA and PFOS in humans. Increases in testicular and kidney cancer have been observed in highly exposed humans.

There is also some suggestive evidence for associations between perfluoroalkyls and additional health outcomes; there is less certainty in these associations due to the higher degree of inconsistencies across studies and/or a smaller number of studies examining a specific outcome. These health outcomes include osteoarthritis in women under 50 years of age (PFOA, PFOS) and decreased antibody response to vaccines (PFNA, PFUA, PFDoA). Additionally, associations between serum PFOA and PFOS and decreases in glomerular filtration rate and increases in serum uric acid levels and between serum PFOA, PFOS, PFHxS, and PFNA and increased risk of early menopause have been observed; these effects may be due to reverse causation and not perfluoroalkyl toxicity.

Effects in Laboratory Animals. Most of the information regarding the effects of perfluoroalkyl compounds in animals is derived from oral studies; considerably less information is available from inhalation and dermal exposure studies. PFOA and PFOS are the most studied perfluoroalkyl compounds, with considerably less data for the other compounds. Of the 187 animal studies reviewed in this toxicological profile, 48% examined PFOA, 34% examined PFOS, and 18% examined other perfluoroalkyls (4 studies on PFHxS, 16 studies on PFNA, 1 study on PFUA, 4 studies on PFBuS, 6 studies on PFBA, 6 studies on PFDeA, 2 studies on PFDoA, 1 study on PFOSA, and 3 studies on PFHxA). The primary effects observed in laboratory animals exposed to perfluoroalkyl compounds are liver toxicity, developmental toxicity, and immune toxicity (see Figures 1-1, 1-2, and 1-3; not all of these effects have been observed or examined for all perfluoroalkyl compounds. Based on limited data, the

1. RELEVANCE TO PUBLIC HEALTH

Figure 1-1. Health Effects Found in Animals Following Oral Exposure to PFOA

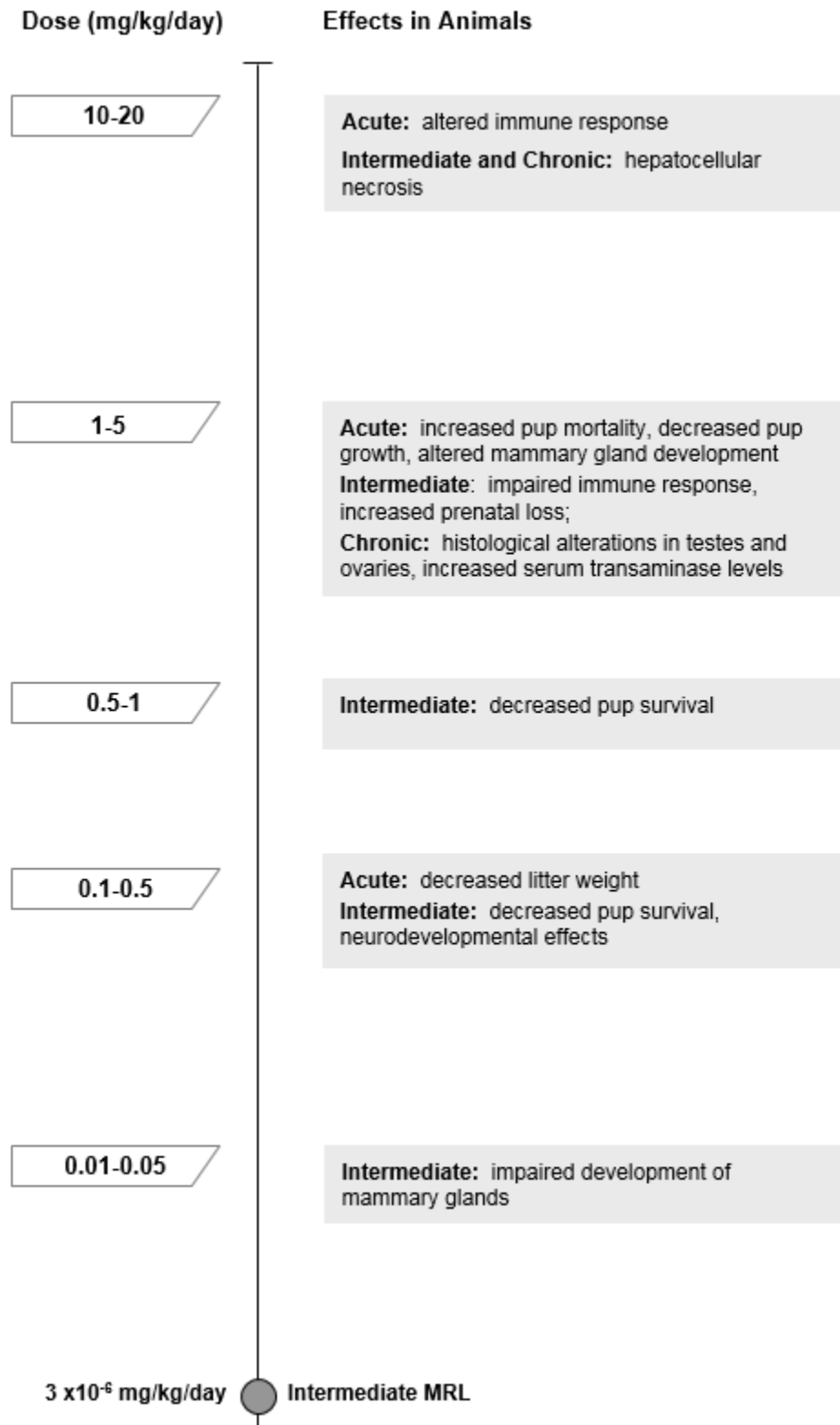

1. RELEVANCE TO PUBLIC HEALTH

Figure 1-2. Health Effects Found in Animals Following Oral Exposure to PFOS

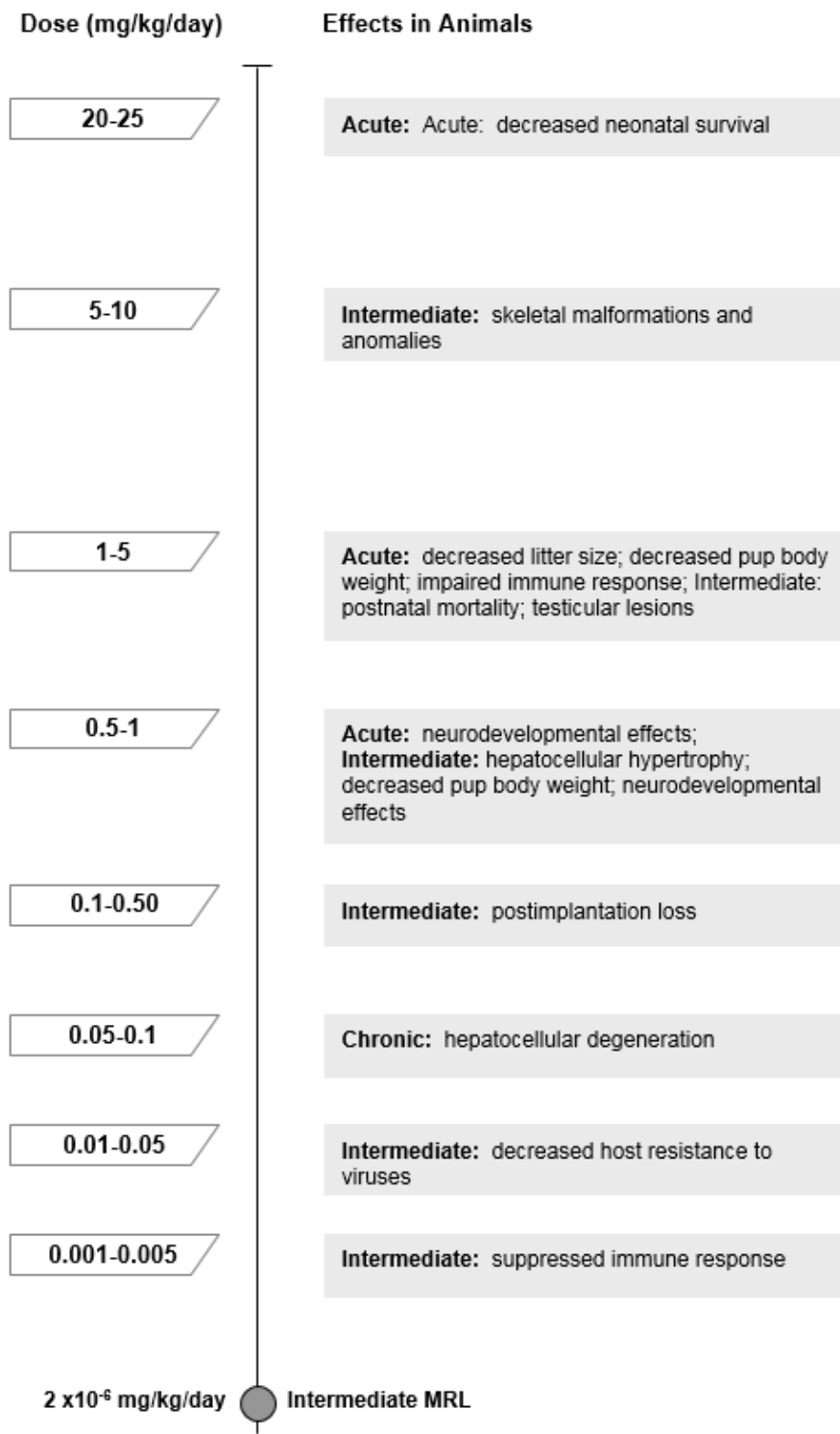

1. RELEVANCE TO PUBLIC HEALTH

Figure 1-3. Health Effects Found in Animals Following Oral Exposure to Other Perfluoroalkyls

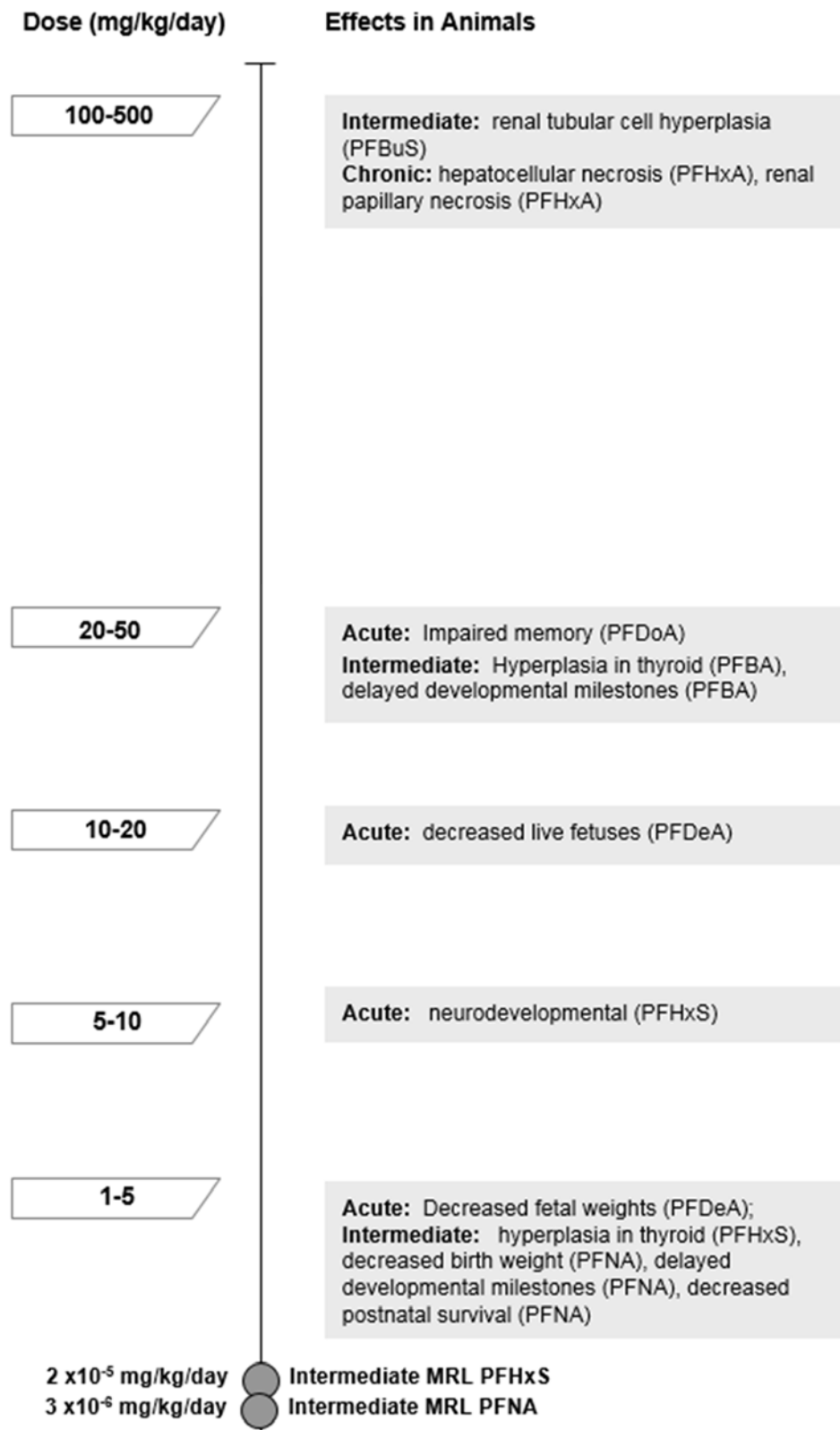

1. RELEVANCE TO PUBLIC HEALTH

toxicity of perfluoroalkyl compounds does not appear to be specific to the route of administration. It should be noted that, for the most part, adverse health effects in studies in animals have been associated with exposure concentrations or doses that resulted in blood levels of perfluoroalkyl compounds that were significantly higher than those reported in perfluoroalkyl workers or in the general population.

Furthermore, there are profound differences in the toxicokinetics of perfluoroalkyls between humans and experimental animals. The elimination $t_{1/2}$ of PFOA is approximately 4 years in humans compared with days or hours in rodents. These factors, plus issues related to the mode of action of perfluoroalkyls (see below), make it somewhat difficult at this time to determine the true relevance of some effects reported in animal studies to human health.

Many of the adverse health effects observed in laboratory animals result from the ability of these compounds (with some structural restrictions) to activate the PPAR α , which can mediate a broad range of biological responses (Issemann and Green 1990). Species differences in the response to PPAR α agonists have been found; rats and mice are the most sensitive species and guinea pigs, nonhuman primates, and humans are less responsive. Although humans are less responsive to PPAR α agonists, they do have a functional PPAR α . Several explanations for these species differences have been suggested (e.g., differences in the ability of PPAR α to be induced after exposure to a peroxisome proliferator and differences in the pattern and level of tissue-specific expression of PPAR α). Activation of this receptor in rodents initiates a characteristic sequence of morphological and biochemical events, principally, but not exclusively, in the liver (Cattley et al. 1998; Kennedy et al. 2004; Klaunig et al. 2003). The proliferation of peroxisomes has been associated with a variety of effects, including hepatocellular hypertrophy, alterations in lipid metabolism, and decreased pup survival and immune effects. Studies in PPAR α -null mice provide evidence that PPAR α -independent mechanisms are also involved in PFOA and PFOS toxicity, including liver and immune toxicity. A more complete discussion of the mechanisms of PFOA and PFOS toxicity is presented in Section 2.20.

Liver Effects. Many studies have described morphological and biochemical alterations in the liver from rodents following acute and longer-term oral exposure to PFOA. Some of the effects observed in rats include increases in liver weight, hepatocellular hypertrophy, and decreases in serum cholesterol and triglyceride levels (e.g., Butenhoff et al. 2004b; Liu et al. 1996; Pastoor et al. 1987; Yang et al. 2001). The observed hepatomegaly and hypertrophy are likely due to expansion of the smooth endoplasmic reticulum and proliferation of peroxisomes, as confirmed by increased activity of biochemical markers and light and electron microscopy (Pastoor et al. 1987). It is important to note also that there appear to be different sensitivities for different endpoints. For example, in male rats dosed with PFOA for 14 days,

1. RELEVANCE TO PUBLIC HEALTH

absolute liver weight and fatty acid β -oxidation activity were significantly increased at 2 mg/kg/day, whereas hepatic microsomal concentration of total cytochrome P450 was significantly increased at 20 mg/kg/day (Liu et al. 1996). In general, longer-term studies with PFOA have shown that the hepatic effects are reversible once dosing ceases and that recovery tends to parallel the decline in blood levels of PFOA (Perkins et al. 2004). Studies in mice have provided similar results. However, studies in PPAR α -null mice suggest that hepatomegaly may also be due to a PPAR α -independent process in mice (Yang et al. 2002b), since PFOA induced hepatomegaly to the same extent in wild-type mice and PPAR α -null mice, but failed to increase acyl-CoA oxidase activity in PPAR α -null mice. PFOA exposure also resulted in increases in absolute liver weight in monkeys treated with ≥ 3 mg/kg/day for 26 weeks, an effect that was partly associated with significant mitochondrial proliferation, but not peroxisome proliferation (Butenhoff et al. 2002).

Similar to PFOA, PFOS exposure results in increases in liver weight, hepatocellular hypertrophy, and decreases in serum cholesterol and triglyceride levels in rodents (e.g., Elcombe et al. 2012a, 2012b; Era et al. 2009; Seacat et al. 2003; Thibodeaux et al. 2003). PFOS induced an increase in absolute liver weight, a decrease in serum cholesterol, and hepatocellular hypertrophy and lipid vacuolation in monkeys in a 26-week study (Seacat et al. 2002). Not unexpectedly, there was no evidence of peroxisome proliferation and no increase in hepatic palmitoyl-CoA oxidase, consistent with the fact that monkeys (and humans) seem to be refractory to peroxisome proliferative responses (Cattley et al. 1998; Klaunig et al. 2003).

Studies with other perfluoroalkyl compounds have shown that, in general, liver weight and parameters of fatty acid β -oxidation are more severely affected as the carbon length increases up to about a 10-carbon chain length (Butenhoff et al. 2009a, 2012a; Goecke-Flora and Reo 1996; Goecke et al. 1992; Hoberman and York 2003; Kudo et al. 2000, 2006; Permadi et al. 1992, 1993; van Otterdijk 2007a, 2007b). Significant peroxisome activity seems to require a carbon length >7 (Goecke-Flora and Reo 1996; Goecke et al. 1992), but increases over control levels have been reported with a four-carbon chain length (Permadi et al. 1993; Wolf et al. 2008a). In an *in vitro* study in mouse COS-1 cells, PFOA had the lowest effective concentration needed for PPAR α activation followed by PFNA and PFDeA, PFHxA, and PFBA (Wolf et al. 2008a). This pattern was not found for the sulfonates; the lowest effective concentration was for PFHxS followed by PFOS and PFBuS. Wolf et al. (2008a) also found that carboxylate perfluoroalkyls activated PPAR α at lower concentrations than the sulfonate perfluoroalkyls. Studies have shown that the differential activity is also related to differential accumulation of the perfluoroalkyl compound in the liver (Kudo and Kawashima 2003; Kudo et al. 2000, 2006). Hydrophobicity, which

1. RELEVANCE TO PUBLIC HEALTH

increases as carbon length increases, seems to favor biliary enterohepatic recirculation, resulting in a more protracted toxicity (Goecke-Flora and Reo 1996).

Developmental Effects. PFOA and PFOS have induced developmental effects in rodents. Most studies with PFOA have been conducted in mice, probably because of the relatively short half-life for PFOA in female rats, which would prevent accumulation of PFOA during the dosing period. Specific effects reported include prenatal loss, reduced neonate weight and viability, neurodevelopment toxicity, and delays in mammary gland differentiation, eye opening, vaginal opening, and first estrus (Abbott et al. 2007; Albrecht et al. 2013; Cheng et al. 2013; Johansson et al. 2008; Koskela et al. 2016; Lau et al. 2006; Macon et al. 2011; Ngo et al. 2014; Onishchenko et al. 2011; Sobolewski et al. 2014; White et al. 2007, 2009, 2011; Wolf et al. 2007; Yahia et al. 2010). These effects occurred generally in the absence of overt maternal toxicity. Some of these effects, such as reduced pup survival from birth to weaning, have been observed in mice treated with as low as 0.6 mg/kg/day PFOA on gestation days (GDs) 1–17 (Abbott et al. 2007). This dose level resulted in mean serum PFOA concentrations of 5,200 and 3,800 ng/mL in dams and pups, respectively, on postnatal day (PND) 22. A cross-fostering study in mice showed that *in utero*, lactation only, and *in utero* and lactation exposure resulted in significant decreases in postnatal growth (Wolf et al. 2007). Alterations in spontaneous behavior were reported in 2- or 4-month-old male mice that were administered a single gavage dose of PFOA at the age of 10 days (Johansson et al. 2008). Increases in motor activity were also observed following *in utero* exposure to PFOA (Cheng et al. 2013; Onishchenko et al. 2011). A cross-fostering study showed that the delays in mammary gland development were observed following *in utero* exposure and following lactation-only exposure (White et al. 2009); however, the results of a 2-generation study showed that the delayed development did not appear to affect lactational support (White et al. 2011). No fetal toxicity or teratogenicity was reported in offspring of rabbits exposed to up to 50 mg/kg/day PFOA on GDs 6–18 (Gortner et al. 1982), suggesting that rabbits are less susceptible than mice to the developmental effects of PFOA, although comparing administered doses is probably not very informative. There were significant increases in body weight gain in mice aged 10–40 weeks that were exposed to low levels of PFOA (0.01–0.3 mg/kg/day) on GDs 1–17 (Hines et al. 2009). Increases in serum insulin and leptin levels were also observed, but there was no change in serum glucose or the response to a glucose challenge. A comparison of the effects of *in utero* exposure (GDs 1–17) to adult exposure (17 days at age 8 weeks) demonstrated that *in utero* exposure resulted in higher body weights, white fat weight, and brown fat weight at age 18 months (Hines et al. 2009).

1. RELEVANCE TO PUBLIC HEALTH

Studies conducted with wild-type and PPAR α knockout mice showed that PPAR α was required for PFOA-induced postnatal lethality and that the expression of one copy of the gene was sufficient to mediate this effect (Abbott et al. 2007). Strain or PPAR α expression did not affect serum PFOA levels. The mechanism of reduced postnatal viability has not been elucidated. Alterations in gene expression in both fetal liver and lung have been reported following exposure of mice to PFOA during pregnancy (Rosen et al. 2007). In the liver, PFOA altered the expression of genes linked to fatty acid catabolism, lipid transport, ketogenesis, glucose metabolism, lipoprotein metabolism, cholesterol biosynthesis, steroid metabolism, bile acid biosynthesis, phospholipid metabolism, retinol metabolism, proteasome activation, and inflammation. In the lung, transcriptional-related changes were predominantly associated with fatty acid catabolism. Although decreased pup survival appears to be linked to PPAR α expression, there are insufficient data to determine whether other developmental effects observed in rats and mice are PPAR α -independent.

PFOS significantly decreased birth weight and survival in neonatal rats exposed *in utero* (Chen et al. 2012b; Lau et al. 2003; Xia et al. 2011), and cross-fostering exposed pups with unexposed dams failed to improve survival rates (Lau et al. 2003). PFOS serum levels of pups at birth associated with significant decreased survival were approximately $\geq 70,000$ ng/mL. Dosing rats late during gestation (GDs 17–20) caused significantly more lethality than dosing early (GDs 2–5) (Grasty et al. 2003). Since pups had difficulty breathing within minutes of birth and their lungs showed evidence of delayed lung maturation and other histological alterations (Grasty et al. 2003, 2005; Yahia et al. 2008), the possibility that this caused the early death has been suggested. Other effects included decreases in birth weight or pup body weight, delays in eye opening, cleft palate, and neurodevelopmental alterations (Butenhoff et al. 2009b; Case et al. 2001; Chen et al. 2012b; Era et al. 2009; Fuentes et al. 2006, 2007a, 2007b; Lau et al. 2003; Luebker et al. 2005a, 2005b; Onishchenko et al. 2011; Thibodeaux et al. 2003; Wang et al. 2015c; Yahia et al. 2008). Alterations in spontaneous motor activity were observed in mice. A decrease in activity was observed when mice were placed in a novel environment (Fuentes et al. 2007a; Onishchenko et al. 2011); another study found a decrease in motor activity followed by increased activity (Johansson et al. 2009). Evaluation of immunological parameters in 8-week-old pups from mice exposed to PFOS during gestation showed reduced natural killer (NK) cell activity, suppressed IgM response to immunization, and alterations in splenic and thymic lymphocyte subpopulations (Keil et al. 2008).

Similar to PFOA and PFOS, increases in fetal mortality were observed in mice exposed to PFDeA on GDs 6–15 (Harris and Birnbaum 1989) and decreases in litter size and pup survival were observed in mice exposed to PFNA (Wolf et al. 2010). In contrast, gestational exposure to PFBA, PFBuS, or PFHxS

1. RELEVANCE TO PUBLIC HEALTH

did not result in alterations in pup survival or pup body weight (Das et al. 2008; Hoberman and York 2003; Lieder et al. 2009b). Decreases in spontaneous activity followed by an increase in activity were observed in mice exposed to PFHxS on PND 10 (Viberg et al. 2013); no alterations were observed in mice similarly exposed to PFDeA (Johansson et al. 2008).

Immunological Effects. A number of studies have examined the immunotoxicity of perfluoroalkyls in rats and mice; these data suggest that mice are considerably more sensitive than rats. PFOA- and PFOS-induced immunological alterations in adult mice are characterized by thymus and spleen atrophy, alterations in thymic and splenic lymphocyte phenotypes, and impaired response to T-dependent antigens (DeWitt et al. 2008, 2009; Dong et al. 2009; Guruge et al. 2009; Lefebvre et al. 2008; Loveless et al. 2008; Qazi et al. 2012; Yang et al. 2000, 2002a; Zheng et al. 2009). The lowest lowest-observed-adverse-effect level (LOAEL) for immune effects in mice exposed to PFOA was 3.75 mg/kg/day administered for 15 days; this dosing level resulted in a mean PFOA serum level of 75,000 ng/mL (DeWitt et al. 2008). For PFOS, several studies identified LOAELs of 0.02–0.8 mg/kg/day (Dong et al. 2009, 2011; Zheng et al. 2009) and one study identified a LOAEL of 0.00166 mg/kg/day for suppressed response to a T-dependent antigen (Peden-Adams et al. 2008). PFOA applied to the skin of mice increased serum IgE levels following a challenge with ovalbumin relative to mice treated with ovalbumin alone, which led the investigators to suggest that PFOA may increase the IgE response to environmental allergens (Fairley et al. 2007). More limited data are available for other perfluoroalkyls. Thymic and/or splenic alterations were observed in rats and mice administered ≥ 1 mg/kg/day PFNA (Fang et al. 2008, 2009, 2010). No histological alterations were observed in rodents exposed to PFHxS (Butenhoff et al. 2009a), PFDeA (Harris et al. 1989), PFBuS (3M 2001), or PFBA (3M 2007a; Butenhoff et al. 2012a; van Otterdijk 2007a, 2007b).

Cancer Effects. PFOA, as many other PPAR α agonists, induced hepatocellular adenomas, Leydig cell adenomas, and pancreatic acinar cell adenomas in rats (Biegel et al. 2001). Liver tumors induced by PFOA are believed to be mediated largely through PPAR α activation, and considered to be of limited or no relevance to humans (EPA 2016h), based on species differences in response to PPAR α activation. Although Leydig cell tumors are also commonly induced by peroxisome proliferating agents, the mode of action by which these tumors are induced by PFOA, and thus their relevance to humans, is much less clear (Corton et al. 2014; EPA 2016h; Klaunig et al. 2003). One mode of action proposed for the induction of Leydig cell tumors involves PFOA-induced decreases in circulating testosterone levels, leading to increased production of gonadotropin releasing hormone and circulating luteinizing hormone (LH), which promotes Leydig cell proliferation. Reduced testosterone levels may occur through

1. RELEVANCE TO PUBLIC HEALTH

decreased biosynthesis, or via the conversion of testosterone to estradiol via the enzyme aromatase, both of which may be related to PPAR α activation (EPA 2016h). However, the data supporting a PPAR α -dependent mode of action for Leydig cell tumors is not sufficiently established to rule out human relevance (EPA 2016h). Likewise, the mechanism of PFOA-induced pancreatic acinar cell tumors may include a PPAR α -dependent component, but the mechanism has not been fully elucidated, and relevant data are limited. A proposed mode of action involves stimulation of PPAR α leading to reduced bile flow and/or changes in bile acid composition with subsequent increase in cholecystokinin (CCK), which stimulates pancreatic cell proliferation and tumor formation (EPA 2016h). Support for this mode of action is limited to information demonstrating increased biliary excretion of PFOA in wild-type and PPAR α null mice (Minata et al. 2010) and data showing altered expression of bile acid transporters (OATPs and MRPs) in exposed laboratory animals (Cheng and Klassen 2008a; Maher et al. 2008). The limitations in available data on the mode of action for pancreatic tumor preclude a conclusion regarding the human relevance of PFOA-induced pancreatic tumors (EPA 2016h).

1.3 MINIMAL RISK LEVELS (MRLs)

A summary of the provisional MRLs derived for perfluoroalkyl compounds is presented in Table 1-2. The database was not considered adequate for derivation of inhalation MRLs. Though inhalation data are available for PFOA and PFNA, these studies examined a limited number of endpoints and the data are not adequate for identifying the most sensitive targets of toxicity or establishing dose-response relationships. No inhalation data are available for other perfluoroalkyl compounds.

Table 1-2. Overview of Provisional Minimal Risk Levels Derived for Perfluoroalkyl Compounds

Compound	Inhalation MRLs			Oral MRLs		
	Acute	Intermediate	Chronic	Acute	Intermediate	Chronic
PFOA	X ^a	X	X	X	3x10 ⁻⁶ mg/kg/day (Table 1-3)	X
PFOS	X	X	X	X	2x10 ⁻⁶ mg/kg/day (Table 1-4)	X
PFHxS	X	X	X	X	2x10 ⁻⁵ mg/kg/day (Table 1-5)	X
PFNA	X	X	X	X	3x10 ⁻⁶ mg/kg/day (Table 1-6)	X
PFDeA	X	X	X	X	X	X
PFUA	X	X	X	X	X	X
PFHpA	X	X	X	X	X	X

1. RELEVANCE TO PUBLIC HEALTH

Table 1-2. Overview of Provisional Minimal Risk Levels Derived for Perfluoroalkyl Compounds

Compound	Inhalation MRLs			Oral MRLs		
	Acute	Intermediate	Chronic	Acute	Intermediate	Chronic
PFBuS	X	X	X	X	X	X
PFBA	X	X	X	X	X	X
PFDoA	X	X	X	X	X	X
PFHxA	X	X	X	X	X	X
PFOSA	X	X	X	X	X	X
Me-PFOSA-AcOH	X	X	X	X	X	X
Et-PFOSA-AcOH	X	X	X	X	X	X

^aX indicates that no MRL was derived.

Et-PFOSA-AcOH = 2-(N-ethyl-perfluorooctane sulfonamide) acetic acid; Me-PFOSA-AcOH = 2-(N-methyl-perfluorooctane sulfonamide) acetic acid; PFBA = perfluorobutyric acid; PFBuS = perfluorobutane sulfonic acid; PFDeA = perfluorodecanoic acid; PFDoA = perfluorododecanoic acid; PFHpA = perfluoroheptanoic acid; PFHxA = perfluorohexanoic acid; PFHxS = perfluorohexane sulfonic acid; PFNA = perfluorononanoic acid; PFOA = perfluorooctanoic acid; PFOS = perfluorooctane sulfonic acid; PFOSA = perfluorooctane sulfonamide; PFUA = perfluoroundecanoic acid

The oral databases were considered adequate for derivation of provisional intermediate-duration oral MRLs for PFOA, PFOS, PFHxS, and PFNA based on laboratory animal data. The databases were not considered adequate for derivation of MRLs for the other perfluoroalkyl compounds. Hepatic, immune, and developmental endpoints were the most sensitive targets in laboratory animals exposed to PFOA (see Figure 1-4) and PFOS (see Figure 1-5), respectively. The most sensitive targets were hepatic and thyroid endpoints for PFHxS and body weight and developmental endpoints for PFNA. The provisional MRL values for PFOA, PFOS, PFHxS, and PFNA are summarized in Tables 1-3, 1-4, 1-5, and 1-6 and discussed in greater detail in Appendix A.

1. RELEVANCE TO PUBLIC HEALTH

Figure 1-4. Summary of Sensitive Targets of PFOA – Oral

Developmental endpoints are the most sensitive target of PFOA.
 Numbers in circles are the lowest LOAELs for all health effects in animals.

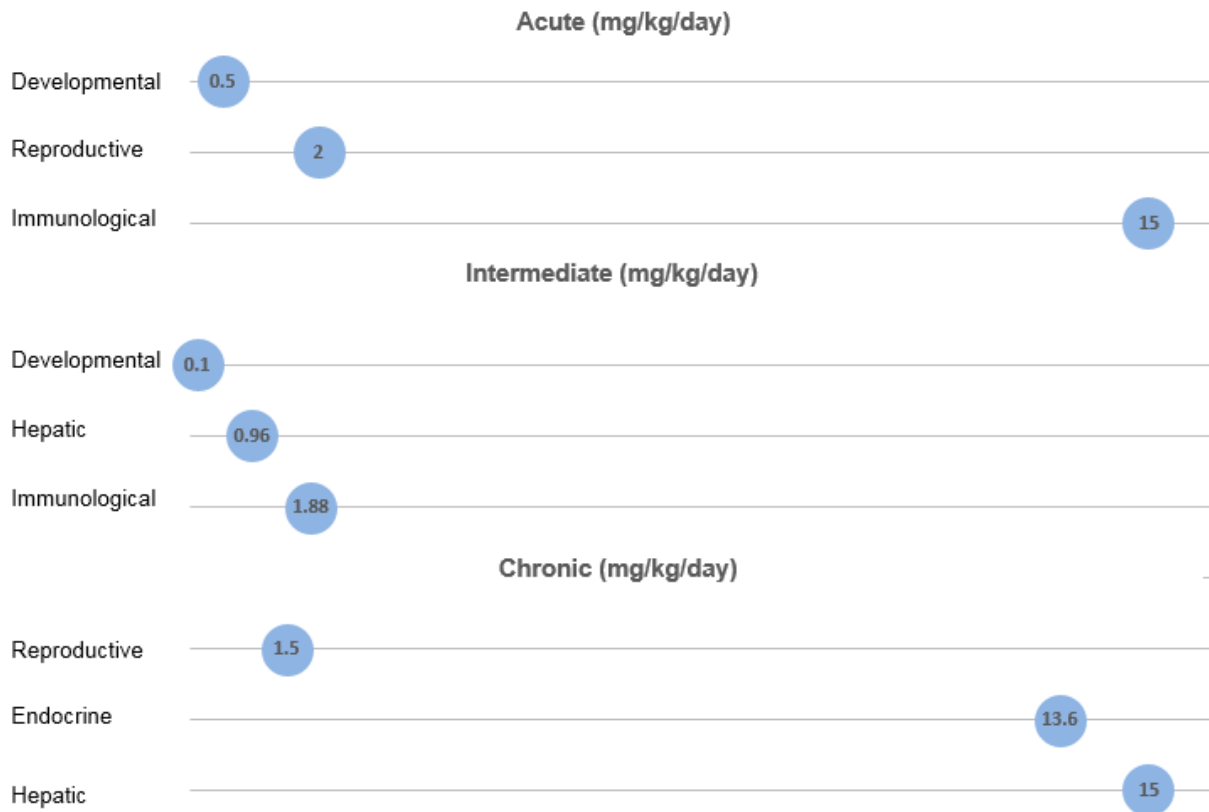

1. RELEVANCE TO PUBLIC HEALTH

Figure 1-5. Summary of Sensitive Targets of PFOS – Oral

The immune system and developing organism are the most sensitive targets of PFOS.
 Numbers in circles are the lowest LOAELs for all health effects in animals.

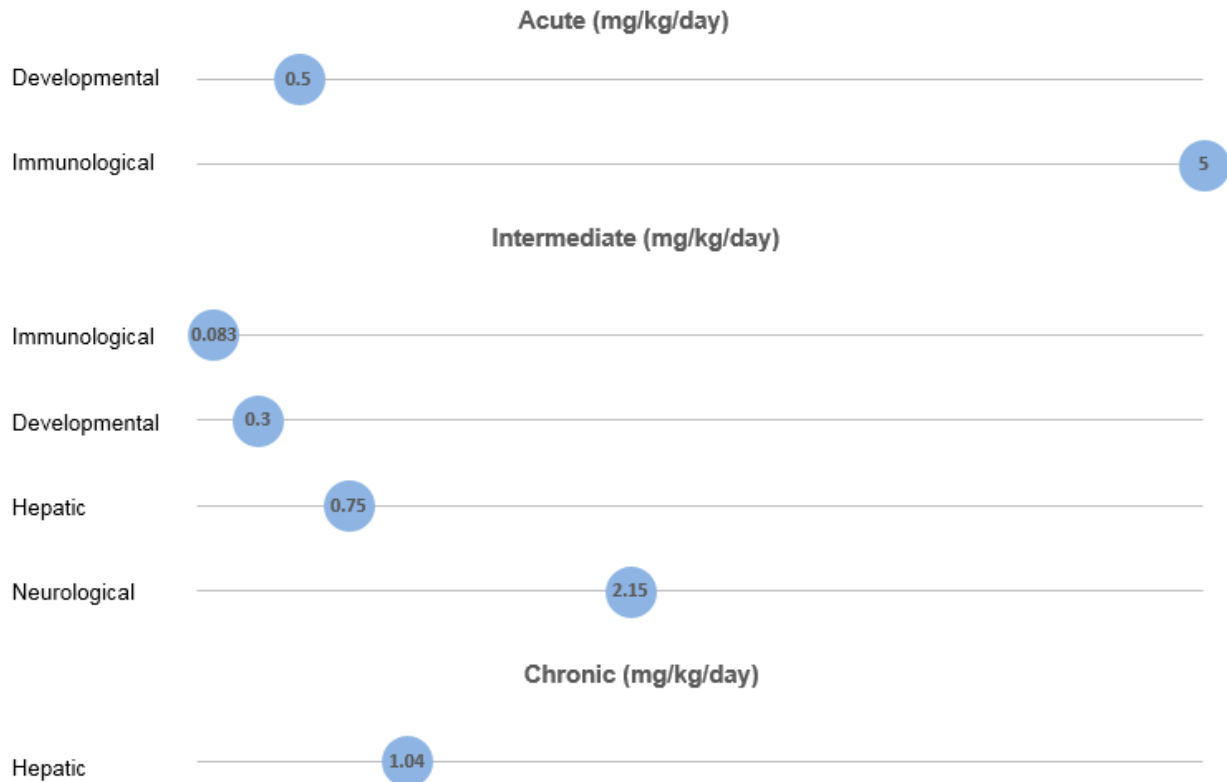

1. RELEVANCE TO PUBLIC HEALTH

Table 1-3. Provisional Minimal Risk Levels (MRLs) for PFOA^a

Exposure duration	MRL	Critical effect	Point of departure	Uncertainty factor	Reference
Inhalation exposure					
Acute	Insufficient data for MRL derivation				
Intermediate	Insufficient data for MRL derivation				
Chronic	Insufficient data for MRL derivation				
Oral exposure (mg/kg/day)					
Acute	Insufficient data for MRL derivation				
Intermediate	3x10 ⁻⁶	Neurodevelopmental and skeletal effects in mice	0.000821 (LOAEL _{HED})	300	Koskela et al. 2016; Onishchenko et al. 2011
Chronic	Insufficient data for MRL derivation				

^aSee Appendix A for additional information.

HED = human equivalent dose; LOAEL = lowest-observed-adverse-effect level; PFOA = perfluorooctanoic acid

Table 1-4. Provisional Minimal Risk Levels (MRLs) for PFOS^a

Exposure duration	MRL	Critical effect	Point of departure	Uncertainty and modifying factors	Reference
Inhalation exposure					
Acute	Insufficient data for MRL derivation				
Intermediate	Insufficient data for MRL derivation				
Chronic	Insufficient data for MRL derivation				
Oral exposure (mg/kg/day)					
Acute	Insufficient data for MRL derivation				
Intermediate	2x10 ⁻⁶	Delayed eye opening and decreased pup weight in rats	0.000515 (NOAEL _{HED}) ^b	30 10	Luebker et al. 2005a
Chronic	Insufficient data for MRL derivation				

^aSee Appendix A for additional information.

HED = human equivalent dose; NOAEL = no-observed-adverse-effect level; PFOS = perfluorooctane sulfonic acid

1. RELEVANCE TO PUBLIC HEALTH

Table 1-5. Provisional Minimal Risk Levels (MRLs) for PFHxS^a

Exposure duration	MRL	Critical effect	Point of departure	Uncertainty and modifying factors	Reference
Inhalation exposure					
Acute	Insufficient data for MRL derivation				
Intermediate	Insufficient data for MRL derivation				
Chronic	Insufficient data for MRL derivation				
Oral exposure (mg/kg/day)					
Acute	Insufficient data for MRL derivation				
Intermediate	2x10 ⁻⁵	Thyroid follicular cell damage in rats	0.0047 (NOAEL _{HED})	30 10	Butenhoff et al. 2009a
Chronic	Insufficient data for MRL derivation				

^aSee Appendix A for additional information.

HED = human equivalent dose; NOAEL = no-observed-adverse-effect level; PFHxS = perfluorohexane sulfonic acid

Table 1-6. Provisional Minimal Risk Levels (MRLs) for PFNA^a

Exposure duration	MRL	Critical effect	Point of departure	Uncertainty and modifying factors	Reference
Inhalation exposure					
Acute	Insufficient data for MRL derivation				
Intermediate	Insufficient data for MRL derivation				
Chronic	Insufficient data for MRL derivation				
Oral exposure (mg/kg/day)					
Acute	Insufficient data for MRL derivation				
Intermediate	3x10 ⁻⁶	Decreased body weight and developmental delays in mice	0.001 (NOAEL _{HED})	30 10	Das et al. 2015
Chronic	Insufficient data for MRL derivation				

^aSee Appendix A for additional information.

HED = human equivalent dose; NOAEL = no-observed-adverse-effect level; PFNOA = perfluorononanoic acid

CHAPTER 2. HEALTH EFFECTS

2.1 INTRODUCTION

The primary purpose of this chapter is to provide public health officials, physicians, toxicologists, and other interested individuals and groups with an overall perspective on the toxicology of perfluoroalkyls. It contains descriptions and evaluations of toxicological studies and epidemiological investigations and provides conclusions, where possible, on the relevance of toxicity and toxicokinetic data to public health.

This document discusses information on perfluoroalkyl compounds that have been measured in the serum collected from a representative U.S. population ≥ 12 years of age in the 2003–2004 NHANES (Calafat et al. 2007b), as well as 2 compounds (PFBA and PFHxA) that have been identified in other monitoring studies. These compounds include:

- Perfluorooctanoic acid (PFOA)
- Perfluorooctane sulfonic acid (PFOS)
- Perfluorohexane sulfonic acid (PFHxS)
- Perfluorononanoic acid (PFNA)
- Perfluorodecanoic acid (PFDeA)
- Perfluoroundecanoic acid (PFUA)
- Perfluoroheptanoic acid (PFHpA)
- Perfluorobutane sulfonic acid (PFBuS)
- Perfluorobutyric acid (PFBA)
- Perfluorododecanoic acid (PFDoA)
- Perfluorohexanoic acid (PFHxA)
- Perfluorooctane sulfonamide (PFOSA)
- 2-(N-Methyl-perfluorooctane sulfonamide) acetic acid (Me-PFOSA-AcOH)
- 2-(N-Ethyl-perfluorooctane sulfonamide) acetic acid (Et-PFOSA-AcOH)

The term perfluoroalkyls used throughout the profile is referring to these 14 compounds and may not be applicable to other perfluoroalkyl compounds.

A glossary and list of acronyms, abbreviations, and symbols can be found at the end of this profile.

To help public health professionals and others address the needs of persons living or working near hazardous waste sites, the information in this section is organized by health effect. These data are discussed in terms of route of exposure (inhalation, oral, and dermal) and three exposure periods: acute (≤ 14 days), intermediate (15–364 days), and chronic (≥ 365 days).

2. HEALTH EFFECTS

As discussed in Appendix B, a literature search was conducted to identify relevant studies examining health effect endpoints. Figures 2-1, 2-2, and 2-3 provide an overview of the database of studies in humans or experimental animals included in this chapter of the profile. These studies evaluate the potential health effects associated with inhalation, oral, or dermal exposure to perfluoroalkyls, but may not be inclusive of the entire body of literature.

Summaries of the epidemiology studies, including details on the study design and results, are presented in tables in the *Supporting Document for Epidemiological Studies for Perfluoroalkyls*; briefer summaries of the studies are presented in summary tables for each endpoint. For studies in which the population was divided into perfluoroalkyl exposure categories, such as quartiles, the risk ratio reported in the summary table is for the lowest exposure category with a statistically significant association; risk ratios for higher exposure categories are presented in the *Supporting Document for Epidemiological Studies for Perfluoroalkyls* tables. Summaries of experimental studies are separated by exposure route and are presented in Tables 2-1, 2-2, 2-3, 2-4, 2-5, and 2-6. The inhalation data for PFOA and other perfluoroalkyls are presented in Tables 2-1 and 2-2, respectively. The oral data for PFOA, PFOS, and other perfluoroalkyls are presented in Tables 2-3, 2-4, and 2-5, respectively. The dermal data for PFOA is presented in Table 2-6. In addition, the NOAEL and LOAEL values from inhalation and oral studies are graphically presented in Figures 2-4, 2-5, 2-6, 2-7, and 2-8.

Levels of significant exposure (LSEs) for each route and duration are presented in tables and illustrated in figures. The points in the figures showing no-observed-adverse-effect levels (NOAELs) or lowest-observed-adverse-effect levels (LOAELs) reflect the actual doses (levels of exposure) used in the studies. LOAELs have been classified into "less serious" or "serious" effects. "Serious" effects are those that evoke failure in a biological system and can lead to morbidity or mortality (e.g., acute respiratory distress or death). "Less serious" effects are those that are not expected to cause significant dysfunction or death, or those whose significance to the organism is not entirely clear. ATSDR acknowledges that a considerable amount of judgment may be required in establishing whether an endpoint should be classified as a NOAEL, "less serious" LOAEL, or "serious" LOAEL, and that in some cases, there will be insufficient data to decide whether the effect is indicative of significant dysfunction. However, the Agency has established guidelines and policies that are used to classify these endpoints (ATSDR 2003). ATSDR believes that there is sufficient merit in this approach to warrant an attempt at distinguishing between "less serious" and "serious" effects. The distinction between "less serious" effects and "serious" effects is considered to be important because it helps the users of the profiles to identify levels of exposure at which major health effects start to appear. LOAELs or NOAELs should also help in

2. HEALTH EFFECTS

determining whether or not the effects vary with dose and/or duration, and place into perspective the possible significance of these effects to human health.

A User's Guide has been provided at the end of this profile (see Appendix C). This guide should aid in the interpretation of the tables and figures for LSEs and MRLs.

The discussion of the available data for each health effect is divided into several subsections. Each health effect section begins with an overview, which contains a brief discussion of the available data and conclusions that can be drawn from the data. Compound-specific discussions follow the overview; the perfluoroalkyls are discussed in the following order: PFOA, PFOS, PFHxS, PFNA, PFDeA, PFUA, PFHpA, PFBuS, PFBA, PFD_oA, PFHpA, PFOSA, Me-PFOSA-AcOH, and Et-PFOSA-AcOH. It is noted that for most health effects, there are no data for a number of the perfluoroalkyl compounds. The compound-specific discussions are further divided into Epidemiology Studies and Laboratory Animal Studies; for data-rich endpoints, a compound-specific summary is also included. Each perfluoroalkyl is treated separately in this chapter. Although there is some evidence of similar health outcomes for some compounds, there is evidence of qualitative and mechanistic differences (Peters and Gonzalez 2011).

The health effects of perfluoroalkyls have been evaluated in a large number of epidemiology and animal studies; the literature search framework for identifying these studies is discussed in Appendix B. As illustrated in Figures 2-1, 2-2, and 2-3, most of the health effects data come from epidemiology studies. For PFOA, PFOS, and other perfluoroalkyls, 67, 70, and 73%, respectively, of the health effect studies were in humans; it is noted that a number of epidemiology studies examined more than one perfluoroalkyl compound. Three population categories were examined in epidemiology studies: workers at facilities involved in the production or use of perfluoroalkyls (most of the studies involved workers at two U.S. facilities), communities living near a PFOA manufacturing facility with high levels of PFOA in the drinking water (almost all of the studies involved residents living near a PFOA production facility in West Virginia), and populations exposed to background levels of perfluoroalkyl compounds (referred to as general population studies). Most of the studies of communities living near perfluoroalkyl manufacturing facilities are part of the C8 Health Project and C8 Health Study (C8 is a synonym for PFOA). The C8 Health Project was a population study of Ohio and West Virginia residents living near the DuPont Washington Works facility in West Virginia and was funded by DuPont as part of a class action settlement agreement. The Washington Works facility began using PFOA in 1951 and peak use was in the late 1990s. At the time of enrollment (2005–2006), blood samples were collected from over 69,000 participants who lived, worked, or attended school in six contaminated water districts surrounding

2. HEALTH EFFECTS

the facility for at least 12 months between 1950 and December 2004 (Frisbee et al. 2009); the six water districts were Little Hocking Water Association, Tupper's Plains Chester Water District, Village of Pomeroy, Lubeck Public Service District, Mason County Public Service District, or private water sources within these areas. The participants ranged in age from 1.5 to >100 years, with an average age of 39.1 years.

Serum perfluoroalkyl levels were used as the biomarker of exposure in almost all of the epidemiology studies. The highest levels of serum PFOA were found among workers, followed by the community members, and then the general population. One study of PFOA workers in 2004–2005 reported an average serum PFOA level of 1,000 ng/mL (Sakr et al. 2007a). A study of community members living near this same facility reported a mean serum PFOA level of 423 ng/mL in 2004–2005. In the United States, the mean geometric mean serum PFOA level in 2005–2006 was 3.92 ng/mL (CDC 2018). In a study of two PFOS facilities, mean serum PFOS levels in workers were 960–1,400 ng/mL in 2000 (Olsen et al. 2003a); the geometric mean serum PFOS levels in the U.S. general population in 1999–2000 was 30.4 ng/mL (CDC 2018). Most of the epidemiology studies provided a single serum perfluoroalkyl concentration, which has been shown to be a reliable biomarker of recent exposure; however, it does not provide information on historical exposure. The lack of historical exposure data is a particular limitation of the occupational and community population studies where past exposures were typically higher than current exposures. Another limitation of the epidemiology studies involves co-exposure to multiple perfluoroalkyl compounds. A number of the epidemiology studies have found strong correlations between serum levels of different perfluoroalkyl compounds. *In vitro* studies (Carr et al. 2013; Wolf et al. 2014) have shown that at lower concentrations, binary pairs of perfluoroalkyl compounds demonstrate concentration and response additivity, but deviate from additivity at higher concentrations (Wolf et al. 2014). These possible interactions (or dose additivity) complicate the interpretation of the epidemiology data.

Although a large number of epidemiology studies have examined the potential of perfluoroalkyl compounds to induce adverse health effects, most of the studies are cross-sectional in design and do not establish causality. ATSDR used a weight-of-evidence approach to evaluate whether the available data supported a link between perfluoroalkyl exposure and a particular health effect. This weight-of-evidence approach takes into consideration the consistency of the findings across studies, the quality of the studies, dose-response, and plausibility. It should be noted that although the data may provide strong evidence for an association, it does not imply that the observed effect is biologically relevant because the magnitude of the change may be within the normal limits or not indicative of an adverse health outcome. Plausibility

2. HEALTH EFFECTS

depends primarily on experimental toxicology studies that establish a plausible biological mechanism for the observed effects.

The available epidemiology studies suggest links between perfluoroalkyl exposure and several health outcomes:

- **Hepatic effects.** Increases in serum enzymes and decreases in serum bilirubin, observed in studies of PFOA, PFOS, and PFHxS, are suggestive of liver damage. In addition, the results of epidemiology studies of PFOA, PFOS, PFNA, and PFDeA suggest a link between perfluoroalkyl exposure and increases in serum lipid levels, particularly total cholesterol and LDL cholesterol.
- **Cardiovascular effects.** There is suggestive epidemiological evidence for an association between serum PFOA and PFOS and pregnancy-induced hypertension and/or pre-eclampsia.
- **Endocrine effects.** Epidemiology studies provide suggestive evidence of a link between serum PFOA and PFOS and an increased risk of thyroid disease.
- **Immune effects.** Evidence is suggestive of a link between serum PFOA, PFOS, PFHxS, and PFDeA levels and decreased antibody responses to vaccines. A possible link between serum PFOA levels and increased risk of asthma diagnosis has also been found.
- **Reproductive effects.** A suggestive link between serum PFOA and PFOS levels and an increased risk of decreased fertility has been found.
- **Developmental effects.** Evidence is suggestive of a link between serum PFOA and PFOS and small decreases in birth weight; the decrease in birth weight is <20 g (0.7 ounces) per 1 ng/mL increase in blood PFOA or PFOS level.

As presented in Figures 2-1, 2-2, and 2-3, most of the available literature on the health effects of perfluoroalkyl compounds in laboratory animals was conducted in oral studies, with a few inhalation and dermal exposure studies identified. The most commonly examined endpoints were liver, body weight, developmental, reproductive, and immunological.

The results of the animal studies suggest the following:

- **Hepatic effects.** Evidence from acute, intermediate, and/or chronic oral studies in rats, mice, and monkeys indicates that the liver is a sensitive target of PFOA, PFOS, PFHxS, PFNA, PFDeA, PFUA, PFBA, PFBuS, PFDoA, and PFHpA toxicity. The effects include increases in liver weight, hepatocellular hypertrophy, and decreases in serum lipid levels. The effects were considered specific to rodents and were not considered relevant to humans. Some degenerative and necrotic effects that are likely relevant to humans have also been observed for PFOA, PFOS, and PFHpA.

2. HEALTH EFFECTS

- **Immune effects.** Evidence from acute and intermediate oral studies in mice indicates that immune endpoints are sensitive targets of PFOA and PFOS toxicity. The most commonly reported effect was an impaired response to antigens. No alteration in antigen response was observed in the one study of PFNA. Immune function has not been tested for the other perfluoroalkyl compounds examined in this profile.
- **Reproductive effects.** Decreases in mammary gland development have been observed in mice orally exposed to PFOA. In general, studies of PFOA and PFOS have not found alterations in fertility.
- **Developmental effects.** Evidence from acute and intermediate oral studies in rats and/or mice indicates that developmental endpoints are targets of PFOA, PFOS, PFHxS, PFNA, PFDeA, PFUA, and PFBA toxicity. The developmental effects include decreases in pup body weight, decreases in pup survival, and alterations in locomotor activity.

2. HEALTH EFFECTS

Figure 2-1. Overview of the Number of Studies Examining PFOA Health Effects*

Developmental, hepatic, and body weight effects of PFOA were the most widely examined potential toxicity outcomes
 More studies evaluated health effects in **humans** than **animals** (counts represent studies examining endpoint)

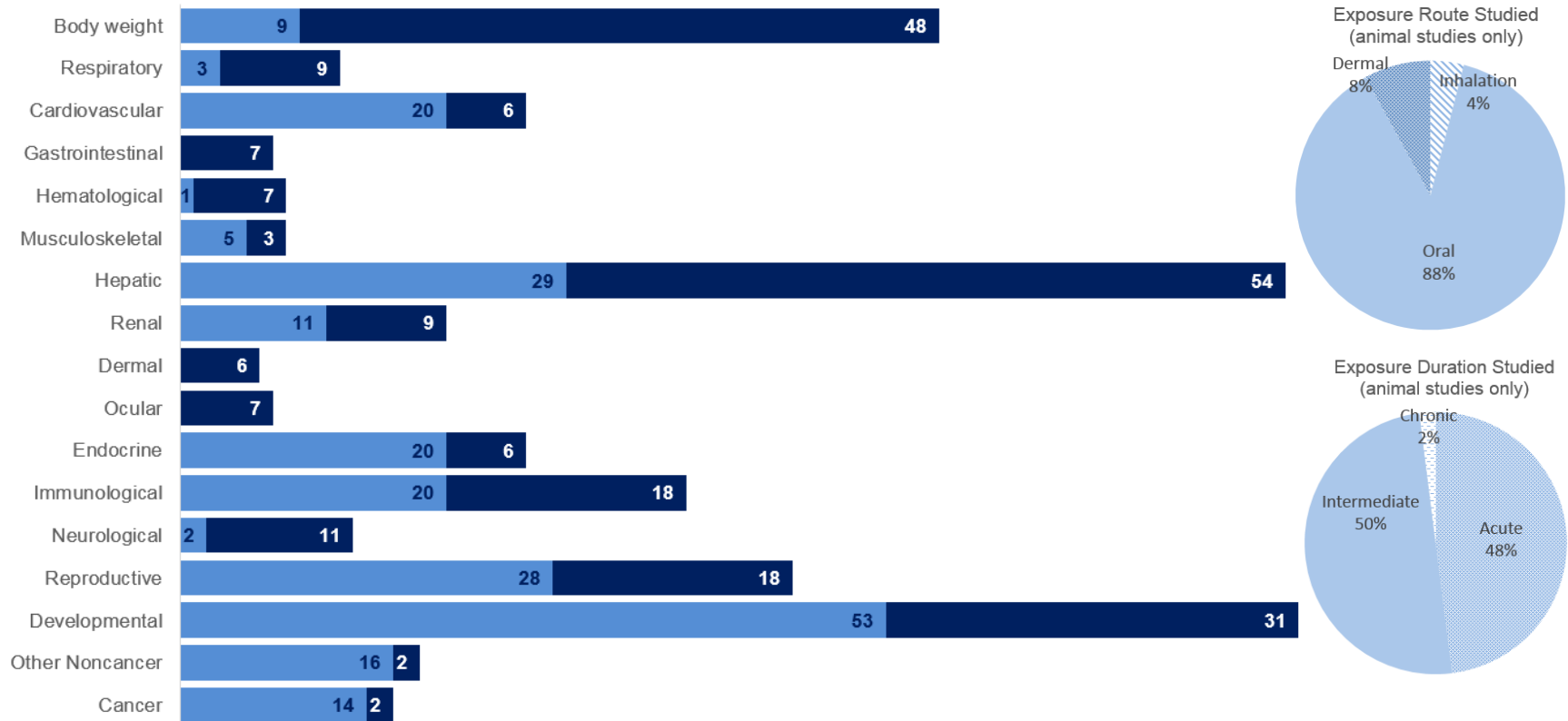

*Includes studies discussed in Chapter 2. A total of 271 studies (including those finding no effect) have examined toxicity; most animal studies examined multiple endpoints. In this figure, the number of human studies is referring to the number of publications.

2. HEALTH EFFECTS

Figure 2-2. Overview of the Number of Studies Examining PFOS Health Effects*

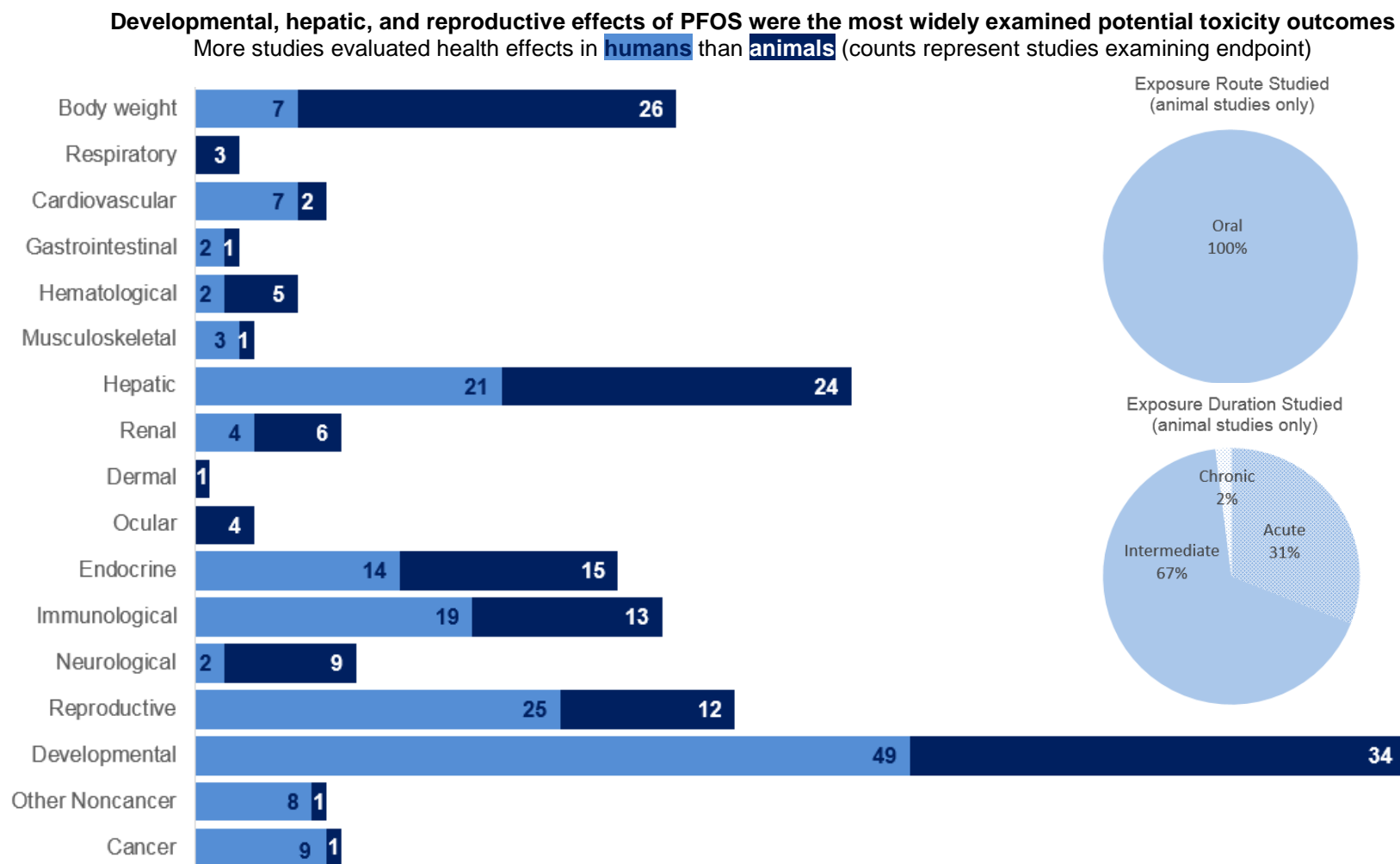

*Includes studies discussed in Chapter 2. A total of 218 studies (including those finding no effect) have examined toxicity; most animal studies examined multiple endpoints. In this figure, the number of human studies is referring to the number of publications.

2. HEALTH EFFECTS

Figure 2-3. Overview of the Number of Studies Examining Other Perfluoroalkyls Health Effects*

Developmental, hepatic, and body weight effects of other perfluoroalkyls were the most widely examined potential toxicity outcomes
 More studies evaluated health effects in **humans** than **animals** (counts represent studies examining endpoint)

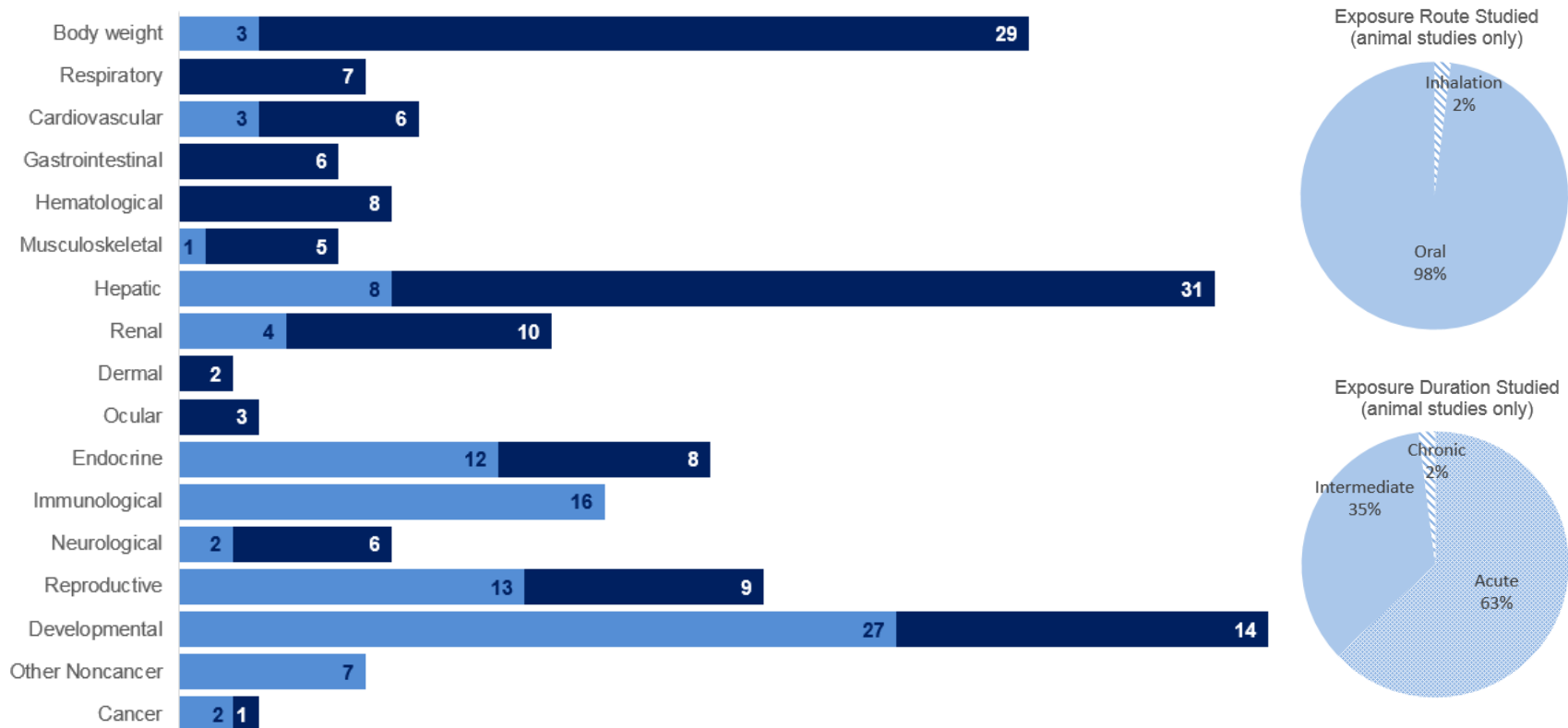

*Includes studies discussed in Chapter 2. A total of 127 studies (including those finding no effect) have examined toxicity; most animal studies examined multiple endpoints. In this figure, the number of human studies is referring to the number of publications.

2. HEALTH EFFECTS

Table 2-1. Levels of Significant Exposure to PFOA – Inhalation

Figure key ^a	Species (strain) No./group	Exposure parameters	Doses (mg/m ³)	Parameters monitored	Endpoint	NOAEL (ppm)	Less serious LOAEL (ppm)	Serious LOAEL (ppm)	Effect
ACUTE EXPOSURE									
1	Rat (albino) 5 M,F	1 hour (NS)	18,600	CS, BW, GN, HP	Resp		18,600		Red nasal discharge; dry rales
					Ocular		18,600		Red material around the eyes; lacrimation
					Neuro		18,600		Excessive salivation
Griffith and Long 1980									
APFO									
2	Rat (CD) 36 M	4 hours	380, 810, 830, 2,200, 4,800, 5,700	CS, HE, BI, GN, HP	Death			980 M	LC ₅₀
					Bd Wt			380 M	Weight loss for 1–2 days after exposure (data not shown)
					Resp			380 M	Pulmonary edema
					Gastro		380 M		Stomach irritation
					Hepatic	810			Liver enlargement at 810 mg/m ³ ; no histological alterations
					Ocular	380 M		810 M	Corneal opacity and corrosion
Kennedy et al. 1986									
APFO									
3	Rat (CD) 24 M	2 weeks 6 hours/day 5 days/week	0, 1, 7.6, 84	CS, HE, BI, GN, HP	Bd Wt	7.6	84		7% lower body weight on exposure day 5
					Resp	84			
					Cardio	84			
					Gastro	84			
					Hemato	84			
					Musc/skel	84			
					Hepatic	84			Increased absolute and relative liver weight; hepatocellular hypertrophy at 7.6 mg/m ³
					Renal	84			
					Dermal	84			
					Ocular	84			
					Endocr	84			
					Neuro	84			No histological alterations
					Repro	84			No histological alterations
Kennedy et al. 1986									

2. HEALTH EFFECTS

Table 2-1. Levels of Significant Exposure to PFOA – Inhalation

Figure key ^a	Species (strain) No./group	Exposure parameters	Doses (mg/m ³)	Parameters monitored	Endpoint	NOAEL (ppm)	Less serious LOAEL (ppm)	Serious LOAEL (ppm)	Effect
APFO									
4	Rat (Sprague-Dawley) 12 F	GDs 6–15 6 hours/day	0, 0.1, 1, 10, 25	MX, DX, OW, CS, HP	Death Bd Wt Hepatic Develop	1 25 10	10 25	25	3/12 deaths on GDs 12, 13, and 17 12% decrease weight gain on GDs 6–15 18% increase absolute liver weight at 25 mg/m ³ 10% decreased neonatal body weight on PND 1
Staples et al. 1984									
APFO									

^aThe number corresponds to entries in Figure 2-4.

APFO = ammonium perfluorooctanoate (ammonia salt of PFOA); BI = biochemical changes; BW or Bd wt = body weight; F = female(s); Cardio = cardiovascular; CS = clinical signs; Develop = developmental; DX = developmental toxicity; Endocr = endocrine; Gastro = gastrointestinal; GD = gestation day; GN = gross necropsy; HE or Hemato = hematology; HP = histopathology; LC₅₀ = lethal concentration, 50% kill; LE = lethality; LOAEL = lowest-observed-adverse-effect level; M = male(s); Musc/skel = musculoskeletal; MX = maternal toxicity; Neuro = neurological; NOAEL = no-observed-adverse-effect level; NS = not specified; OW = organ weight; PFOA = perfluorooctanoic acid; PND = postnatal day; Repro = reproductive; Resp = respiratory

2. HEALTH EFFECTS

Figure 2-4. Levels of Significant Exposure to PFOA – Inhalation
Acute (≤14 days)

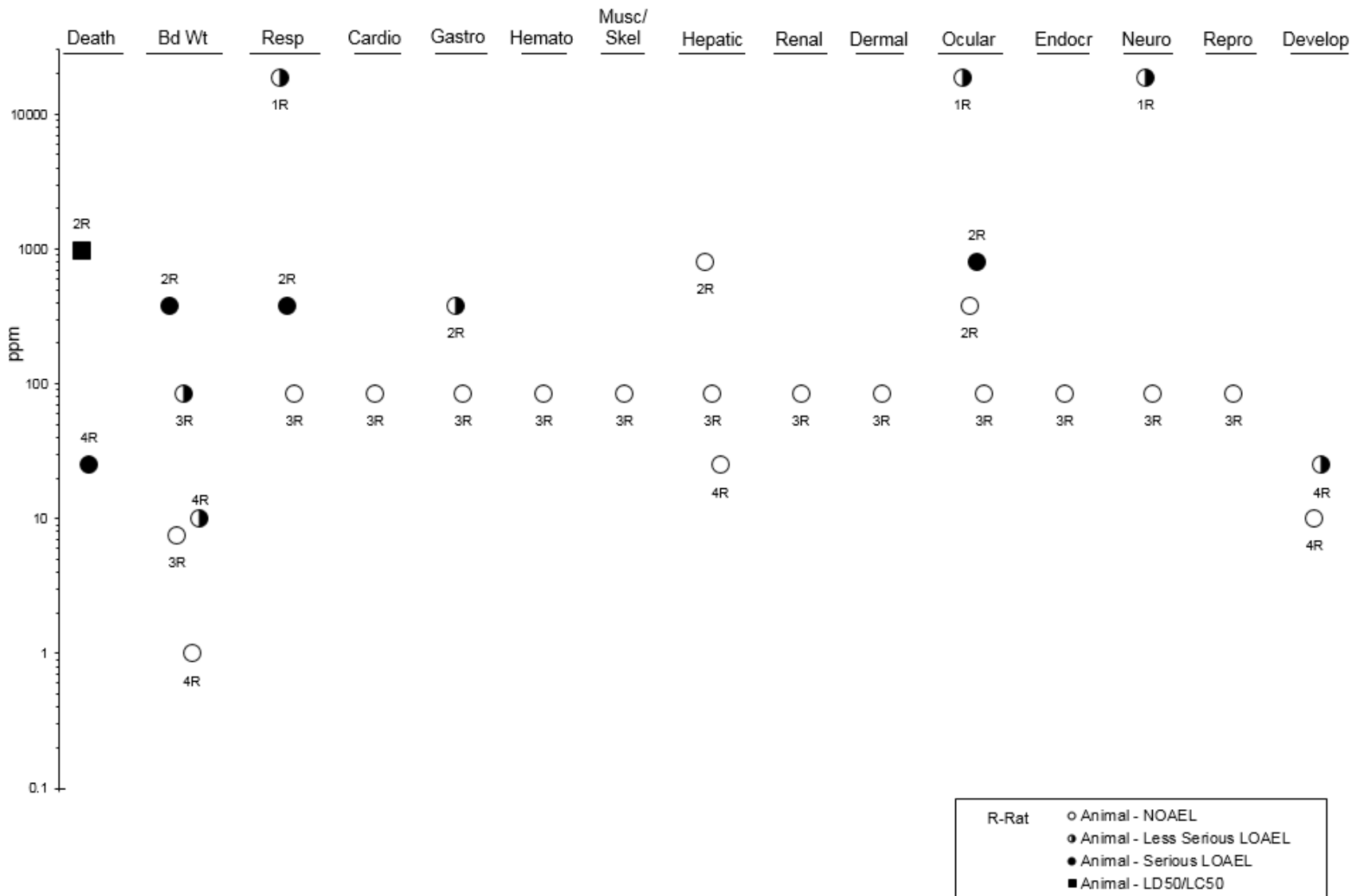

2. HEALTH EFFECTS

Table 2-2. Levels of Significant Exposure to Other Perfluoroalkyls – Inhalation

Figure key ^a	Species (strain) No./group	Exposure parameters	Doses (mg/m ³)	Parameters monitored	Endpoint	NOAEL (ppm)	Less serious LOAEL (ppm)	Serious LOAEL (ppm)	Effect
ACUTE EXPOSURE									
PFNA									
1	Rat (CD) 6 M	4 hours	67–4,600	LE	Death			820	14-day LC ₅₀
Kinney et al. 1989									
Exposure was nose-only.									
2	Rat (CD) 10 M	4 hours	0, 67, 590	BW, OW	Bd Wt Resp Hepatic	67 67 67	590 590		Reduced 18% 5 days after exposure Lung noise; labored breathing during and after exposure 28% increase in absolute liver weight 5 days after exposure to ≥67 mg/m ³
Kinney et al. 1989									
Exposure was nose-only.									

^aThe number corresponds to entries in Figure 2-5.

BW or Bd wt = body weight; LC₅₀ = lethal concentration, 50% kill; LE = lethality; LOAEL = lowest-observed-adverse-effect level; M = male(s); NOAEL = no-observed-adverse-effect level; OW = organ weight; PFNA = perfluorononanoic acid; Resp = respiratory

2. HEALTH EFFECTS

Figure 2-5. Levels of Significant Exposure to Other Perfluoroalkyls – Inhalation Acute (≤14 days)

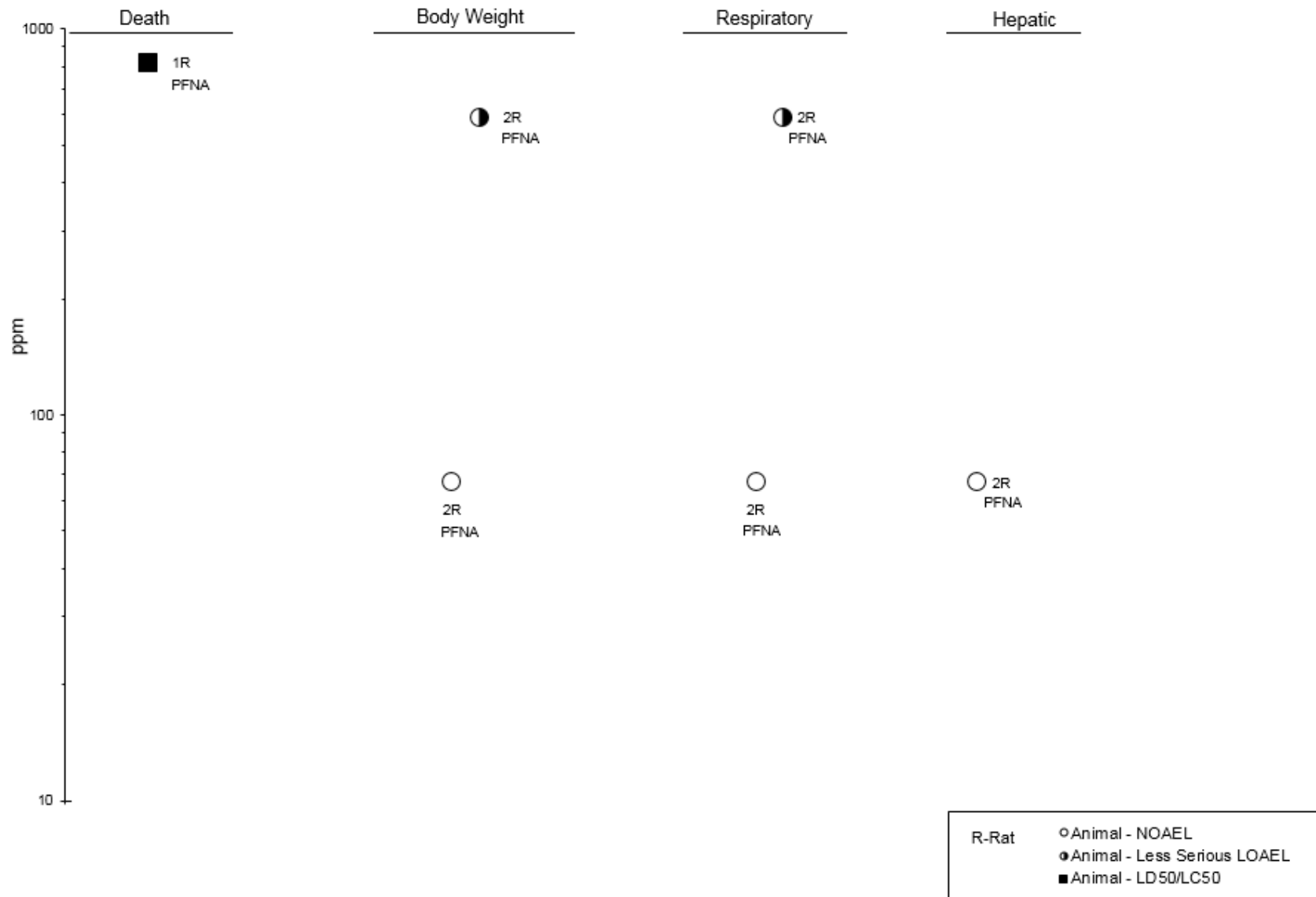

2. HEALTH EFFECTS

Table 2-3. Levels of Significant Exposure to PFOA – Oral

Figure key ^a	Species (strain) No./group	Exposure parameters	Doses (mg/kg/day)	Parameters monitored	Endpoint	NOAEL (mg/kg/day)	Less serious LOAEL (mg/kg/day)	Serious LOAEL (mg/kg/day)	Effect
ACUTE EXPOSURE									
1	Monkey (Rhesus) 10 M,F	2 weeks (G)	0, 3, 10, 30, 100	LE, CS, HE, BI, GN, HP	Death			100	Unspecified number out of 4 died on week 2
Griffith and Long 1980									
APFO									
2	Rat (CD) 10 M	14 days (GW)	0, 25	BI, OW	Repro		25		184% increase in serum estradiol
Biegel et al. 1995									
APFO									
3	Rat (CD) 75 M	14 days (GW)	0, 1, 10, 25, 50	BW, OW, BI, HP	Bd Wt Hepatic Repro	10 50 1	25 10		14% reduction in final body weight 46% increase in relative liver weight at ≥10 mg/kg/day 63% increase in serum estradiol
Cook et al. 1992									
APFO									
4	Rat (Sprague-Dawley) 18 M	1 or 7 days (F)	0, 18, 23		Hepatic	23			Increased liver weight, decreased serum cholesterol, triglyceride, hepatocellular hypertrophy at ≥18 mg/kg/day
Elcombe et al. 2010									
APFO									
5	Rat (albino) 25 M,F	Once (GO)	100, 215, 464, 1,000, 2,150		Death			680 M 430 F	LD ₅₀ LD ₅₀
Griffith and Long 1980									
APFO									

2. HEALTH EFFECTS

Table 2-3. Levels of Significant Exposure to PFOA – Oral

Figure key ^a	Species (strain) No./group	Exposure parameters	Doses (mg/kg/day)	Parameters monitored	Endpoint	NOAEL (mg/kg/day)	Less serious LOAEL (mg/kg/day)	Serious LOAEL (mg/kg/day)	Effect
6	Rat (albino) 40 M,F	28 days (F)	M: 0, 3, 10, 30, 10, 300, 1,000, 3,000; F: 0, 3.4, 11.3, 34, 113, 340, 1,130, 3,400		Death			1,000 M 1,130 F	5/5 males and 5/5 females died before end of 1st week of study
Griffith and Long 1980									
APFO									
7	Rat (Wistar) 8 M	7 days ad lib (F)	0, 16	BW, OW, BI, EA	Bd Wt	16			
					Hepatic	16			66% increase in absolute liver weight
Haughom and Spydevold 1992									
APFO									
8	Rat (Sprague-Dawley) 3 M	14 days (F)	0, 20	OW, EA	Hepatic	20			45% increase in relative liver weight
Ikeda et al. 1985									
PFOA									
9	Rat (Sprague-Dawley) 16 M	14 days (GW)	0, 0.5, 5, 50	BW, OW, CS, HE, BI	Bd Wt Hepatic Immuno	50 50 50			2-fold increased mean relative liver weight at 50 mg/kg/day No alterations in spleen weight or splenocyte phenotype
Iwai and Yamashita 2006									
APFO									

2. HEALTH EFFECTS

Table 2-3. Levels of Significant Exposure to PFOA – Oral

Figure key ^a	Species (strain) No./group	Exposure parameters	Doses (mg/kg/day)	Parameters monitored	Endpoint	NOAEL (mg/kg/day)	Less serious LOAEL (mg/kg/day)	Serious LOAEL (mg/kg/day)	Effect
10	Rat (Wistar) 5–12 M	Once (GO)	0, 50	BW, FX	BW	50			
					Neuro	50			No alteration in performance on novel object recognition test
Kawabata et al. 2017									
PFOA									
11	Rat (Wistar) 30 M	1 week (F)	0, 1.2, 2.4, 4.7, 9.5	BW, OW, EA, HP	Bd Wt	38			
					Hepatic	9.5			Significant increase in absolute and relative liver weight at ≥ 4.7 mg/kg/day
Kawashima et al. 1995									
PFOA									
12	Rat (SD-IGS BR) 10 M	14 days (GW)	0, 0.3, 1, 3, 10, 30,	BW, OW, BC	Bd Wt	1	3		24% decrease in overall body weight gain
					Hepatic	30			Decreased serum cholesterol levels at ≥ 0.3 mg/kg/day
Loveless et al. 2006									
APFO									
13	Rat (CD) 15 M	14 days (G)	0, 0.2, 2, 20, 40	BW, OW, EA	Bd Wt	2	20		14% lower final body weight
					Hepatic	40			34% increase in absolute and relative liver weight at ≥ 2 mg/kg/day
					Repro	0.2	2		2-fold increase in serum estradiol
Liu et al. 1996									
APFO									
14	Rat (Sprague-Dawley) 24 M	1, 3, 7 days (GW)	0, 50	BW, BI, EA, HP	Bd Wt		50		17% weight loss
					Hepatic	50			2-fold increase in relative and absolute liver weight
Pastoor et al. 1987									
APFO									

2. HEALTH EFFECTS

Table 2-3. Levels of Significant Exposure to PFOA – Oral

Figure key ^a	Species (strain) No./group	Exposure parameters	Doses (mg/kg/day)	Parameters monitored	Endpoint	NOAEL (mg/kg/day)	Less serious LOAEL (mg/kg/day)	Serious LOAEL (mg/kg/day)	Effect
15	Rat (Sprague-Dawley) 12 or 25 F	GDs 6–15 (GO)	0, 100	DX, MX, BW	Bd Wt Develop	100		100	33% reduced maternal body weight gain No alterations in fetal body weight or teratology
Staples et al. 1984									
APFO									
16	Mouse (SV129 wild type) 4 M	7 days (G)	0, 10	BW, HP	Bd Wt Hepatic	10 10			Hepatocellular hypertrophy, steatosis, and increased hepatic triglyceride levels
Das et al. 2017									
PFOA									
17	Mouse (C57BL/6N) 6 F	10 days (W)	0, 3.75, 7.5, 15	FX	Immuno	7.5	15		Altered response to sRBC
DeWitt et al. 2009									
PFOA									
18	Mouse (CD) 40 M,F	28 days (F)	M: 0, 5.4, 18.0, 54, 180, 540, 1,800, 5,400; F: 0, 5.8, 19.5, 58, 195, 580, 1,950, 5,800		Death			180 M 195 F	5/5 died before 2nd week of study 5/5 died before 2nd week of study
Griffith and Long 1980									
APFO									
19	Mouse (C57BL/6N) 16 F	GDs 6–17 (DW)	0, 0.5, 1		Bd Wt Develop	1		0.5	7–10% decrease in litter weight on PND 2
Hu et al. 2010									
APFO									

2. HEALTH EFFECTS

Table 2-3. Levels of Significant Exposure to PFOA – Oral

Figure key ^a	Species (strain) No./group	Exposure parameters	Doses (mg/kg/day)	Parameters monitored	Endpoint	NOAEL (mg/kg/day)	Less serious LOAEL (mg/kg/day)	Serious LOAEL (mg/kg/day)	Effect
20	Mouse (CD-1) 10 M	Once (G)	0, 0.58, 8.70	CS, OF, DX	Develop		0.58		Decreased spontaneous activity and altered response to cholinergic stimulant
Johansson et al. 2008									
APFO									
10-day-old mice were administered a single dose of PFOA; neurodevelopmental testing was conducted when the pups were 2 or 4 months of age									
21	Mouse (CD-1) 5 M,F	14 days (F)	0, 5.3, 54, 537	OW	Hepatic	537			123–155% increase in absolute liver weight in 14 days at ≥ 5.3 mg/kg/day
Kennedy 1987									
APFO									
22	Mouse (CD-1) 10 M	14 days (GW)	0, 0.3, 1, 3, 10, 30,	BW, OW, BC	Bd Wt Hepatic	3 30		10	6–12% decreased in body weight gain Decreased serum cholesterol levels at ≥ 0.3 mg/kg/day
Loveless et al. 2006									
APFO									
23	Mouse (C57BL/6N) 3 M	2–10 days (F)	0, 78, 390	BW, OW, EA	Bd Wt Hepatic			78	25% body weight loss after 10 days of treatment 74% increase in absolute liver weight at ≥ 78 mg/kg/day
Permadi et al. 1992									
PFOA									
24	Mouse (C57BL/6N) 4 M	2–10 days (F)	0, 78, 390	BW, OW, EA	Bd Wt Hepatic			78	25% body weight loss after 5 days of treatment 74% increase in absolute liver weight in 5 days at ≥ 78 mg/kg/day
Permadi et al. 1993									
PFOA									

2. HEALTH EFFECTS

Table 2-3. Levels of Significant Exposure to PFOA – Oral

Figure key ^a	Species (strain) No./group	Exposure parameters	Doses (mg/kg/day)	Parameters monitored	Endpoint	NOAEL (mg/kg/day)	Less serious LOAEL (mg/kg/day)	Serious LOAEL (mg/kg/day)	Effect
25	Mouse (BALB/c) 5 F	7 days (GW)	20	BW, OW, BC	Bd wt Hepatic Immuno	20	20		36% decrease in body weight gain 32% increase in relative liver weight Inhibition of T-and B-lymphocyte proliferation in response to sRBC; decreased phagocytosis by peripheral blood cells and NK cell activity; decreased IgM antibody formation in response to OVA
Vetvicka and Vetvickova 2013									
PFOA									
26	Mouse (CD-1) 14 F	GDs 8–17 GDs 1217 (GW)	0, 5	DX, GN	Develop		5		Altered mammary gland development in female pups; reduced pup weight on PND 20
White et al. 2007									
APFO									

2. HEALTH EFFECTS

Table 2-3. Levels of Significant Exposure to PFOA – Oral

Figure key ^a	Species (strain) No./group	Exposure parameters	Doses (mg/kg/day)	Parameters monitored	Endpoint	NOAEL (mg/kg/day)	Less serious LOAEL (mg/kg/day)	Serious LOAEL (mg/kg/day)	Effect
27	Mouse (CD-1) 56 F	GDs 8–17 (GW)	0, 5		Bd Wt	5			40–120% increased relative liver weight in lactating dams on PNDs 1–10 Immature mammary gland morphology in lactating dams on PNDs 1–10 Delayed mammary gland development (30–60%) in female pups on PNDs 1–10
					Hepatic	5			
					Repro		5		
					Develop		5		
White et al. 2009									
APFO									
28	Mouse (CD-1) 12–14 F	GDs 7–17 GDs 10–17 GDs 13–17 GDs 15–17	0, 5		Develop		5		Delayed mammary gland development (31–47%) in female pups on PNDs 22–32 and at 18 months
White et al. 2009									
APFO									
29	Mouse (CD-1) 6–14 F	GDs 7–17, GDs 10–17 GDs 13–17 GDs 15–17 (GW)	0, 5, 20	DX, MX, BW, OW	Bd Wt	20			No alterations in dams dosed on GDs 15–17 Increase in relative liver weight in dams dosed on GDs 13–17, 10–17, or 7–17 at ≥5 mg/kg/day Reduced pup body weight at weaning, 43% in males and 35% in females
					Hepatic	20			
					Develop		5		
Wolf et al. 2007									
APFO									
30	Mouse (C57BL/6N) 8 M	7 days (F)	0, 24	CS, BW, OW, BI	Hepatic	24		24	>10% reduced final body weight 2-fold increase in absolute liver weight
Xie et al. 2003									
PFOA									

2. HEALTH EFFECTS

Table 2-3. Levels of Significant Exposure to PFOA – Oral

Figure key ^a	Species (strain) No./group	Exposure parameters	Doses (mg/kg/day)	Parameters monitored	Endpoint	NOAEL (mg/kg/day)	Less serious LOAEL (mg/kg/day)	Serious LOAEL (mg/kg/day)	Effect
31	Mouse (C57BL/6N) 8 M	10 days (F)	0, 30	BW, OW, BI, CS	Bd Wt Hepatic Immuno	30	30	30	17% decrease in final body weight >90% increase in absolute and relative liver weight 86% reduction in absolute thymus weight; 30% reduction in absolute spleen weight
Yang et al. 2000									
PFOA									
32	Mouse (C57BL/6N) 8 M	10 days (F)	0, 1, 3.5, 11.5, 23, 58	CS, BW, OW, OF, BI	Hepatic Immuno	1	11.5		35% increase in absolute liver weight at ≥1 mg/kg/day 40–50% decrease in spleen and thymus weights
Yang et al. 2001									
PFOA									
33	Mouse (C57BL/6N) 8–12 M	7 days (F)	0, 24	CS, BW, BI, OF	Immuno		24		Decreased humoral response to immunization with horse red blood cells
Yang et al. 2002a									
PFOA									
34	Mouse (C57BL/6N) 16 M	7 days ad lib (F)	0, 33	BW, OW, BI, OF	Bd Wt Hepatic Immuno	33	33	33	14% decreased mean body weight 86% increase in absolute liver weight 40% reduction in spleen weight and 79% reduction in thymus weight
Yang et al. 2002b									
PFOA									
Experiments with PPARα-null mice suggested PPARα-dependent and -independent immune effects									
35	Rabbit (New Zealand) 18 F	GDs 6–18 1 time/day (GW)	0, 1.5, 5, 50	CS, MX, DX, BW	Develop	50			
Gortner et al. 1982									
PFOA									

2. HEALTH EFFECTS

Table 2-3. Levels of Significant Exposure to PFOA – Oral

Figure key ^a	Species (strain) No./group	Exposure parameters	Doses (mg/kg/day)	Parameters monitored	Endpoint	NOAEL (mg/kg/day)	Less serious LOAEL (mg/kg/day)	Serious LOAEL (mg/kg/day)	Effect
INTERMEDIATE EXPOSURE									
36	Monkey (Cynomolgus) 4–6 M	26 weeks 1 time/day (C)	0, 3, 10, 30/20	BC, BW, CS, EA, FI, GN, HE, HP, LE, OP, OW, UR	Bd Wt Resp Cardio Gastro Hemato Musc/skel Hepatic Renal Dermal Ocular Endocr Immuno Neuro Repro	10 20 20 20 20 20 20 20 20 20 20 20 20	20 3 10	30	12% decrease by week 10 36% increase in absolute liver weight at ≥3 mg/kg/day; increased serum triglyceride levels at 30/20 mg/kg/day Significant decrease in serum TT4 (27–35%) and FT4 (30–38%) No histological alterations No histological alterations No histological alterations
Butenhoff et al. 2002									
APFO									
37	Monkey (Rhesus) 10 M,F	90 days 1 time/day (G)	0, 3, 10, 30, 100	LE, CS, HE, BI, GN, HP	Death Bd Wt Cardio Gastro Hemato Hepatic Renal Immuno Neuro	10 10 10 10 30 10 10 10 10	30 30 30 30	30	One male and two females died during weeks 7–12 33% body weight loss by week 6 Emesis Atrophy of lymphoid follicles in spleen and lymph nodes Hypoactivity and prostration

2. HEALTH EFFECTS

Table 2-3. Levels of Significant Exposure to PFOA – Oral

Figure key ^a	Species (strain) No./group	Exposure parameters	Doses (mg/kg/day)	Parameters monitored	Endpoint	NOAEL (mg/kg/day)	Less serious LOAEL (mg/kg/day)	Serious LOAEL (mg/kg/day)	Effect
Griffith and Long 1980									
APFO									
38	Monkey (Cynomolgus) 8 M	30 day 1 time/day (C)	0, 2, 20	CS, BW, FI, BI, HE, EA, GN, HP	Bd Wt Hemato Hepatic Endocr	20 20 20 20			No histological alterations in testes or ovaries
					Repro	20			No alterations in serum estradiol, estriol, or histopathology of the testes
Thomford 2001									
APFO									
39	Rat (CD) 156 M	1 year ad lib (F)	0, 13.6	CS, BW, FI, OW, GN, HP	Bd Wt Hepatic Repro		13.6 13.6		>10% reduced weight gain Increased relative liver weight Significant increase in serum estradiol at 1, 3, 6, 9, and 12 months (~100–180%); prolactin was decreased at all time points, but not always significantly
Biegel et al. 2001									
APFO									
40	Rat (Sprague-Dawley) 30 M,F	70–90 days 1 time/day (GW)	0, 1, 3, 10, 30	MX, DX, OF, BW, GN, HP	Bd Wt Hepatic Renal	3 1	10 3		>11% reduced body weight Increased absolute and relative liver weight in P-generation (36%) and F1-generation (30%) males; hepatocellular hypertrophy and less commonly necrosis in F1 males (incidence not reported) Increased absolute and relative kidney weight in P-generation (14%) and F1-generation (11%) males

2. HEALTH EFFECTS

Table 2-3. Levels of Significant Exposure to PFOA – Oral

Figure key ^a	Species (strain) No./group	Exposure parameters	Doses (mg/kg/day)	Parameters monitored	Endpoint	NOAEL (mg/kg/day)	Less serious LOAEL (mg/kg/day)	Serious LOAEL (mg/kg/day)	Effect
					Endocr	10	30		Vacuolation of zona glomerulosa of adrenal gland
					Repro	30			No alteration in reproductive performance in P0 or F1 generation
					Develop	10		30	Increased number of dead pups on PNDs 6–8
Butenhoff et al. 2004b									
APFO									
41	Rat (Wistar) 5 F	GD 1 to PND 21 ad lib (W)	0, 1.6		Develop		1.6		17–18% reduced motor coordination and increased locomotor activity in pups on PNDs 34–35
Cheng et al. 2013									
PFOA									
42	Rat (Sprague-Dawley) 10 M	Daily 28 days (G)	0, 5, 20	OW, HP	Resp Hepatic		5 5		Cytoplasmic vacuolization, necrosis, hypertrophy, increased liver weight at ≥5 mg/kg/day; fatty degeneration, angiectasis and congestion in the hepatic sinusoid or central vein at 20 mg/kg/day
					Neuro		5		Cachexia and lethargy
Cui et al. 2009									
PFOA									
43	Rat (Sprague-Dawley) 10 M	28 days (F)	0, 18		Hepatic		18		Increased liver weight (43% on day 29), decreased serum cholesterol (39% on day 29) and triglyceride (73% on day 29), hepatocellular hypertrophy and hyperplasia
Elcombe et al. 2010									
APFO									

2. HEALTH EFFECTS

Table 2-3. Levels of Significant Exposure to PFOA – Oral

Figure key ^a	Species (strain) No./group	Exposure parameters	Doses (mg/kg/day)	Parameters monitored	Endpoint	NOAEL (mg/kg/day)	Less serious LOAEL (mg/kg/day)	Serious LOAEL (mg/kg/day)	Effect
44	Rat (CD) 40 M,F	28 days ad lib (F)	M: 0, 3, 10, 30, 100, 300, 1,000, 3,000; F: 0, 3.4, 11.3, 34, 113, 340, 1,130, 3,400	BW, FI, HP	Bd Wt	10 M	30 M	100 M	30 mg/kg/day: 11% reduction in final body weight; 100 mg/kg/day: 33% reduction in final body weight
Griffith and Long 1980									
APFO									
45	Rat (CD) 30 M,F	90 days ad lib (F)	M: 0, 1, 3, 10, 30, 100; F: 0, 1.1, 3.4, 11, 34, 110	CS, BW, FI, HE BI, GN, HP, OW	Bd Wt	30 M 110 F	100 M		33% reduction in final mean body weight
					Resp	100 F			
					Cardio	110 F			
					Gastro	110 F			
					Musc/skel	110 F			
					Hepatic	100 M			Hepatocyte hypertrophy; 50% increase in absolute liver weight
					Renal	110 F			
					Dermal	110 F			
					Ocular	110 F			
					Endocr	110 F			
					Immuno	110 F			
					Neuro	110 F			No histological alterations
					Repro	100 M 110 F			No histological alterations
Griffith and Long 1980									
APFO									
46	Rat (Sprague-Dawley) 10 dams; 12–13 pups	GDs 12–18 (GO)	0, 5, and 20	BC, BW, DX, OW	Bd Wt	5	20		30% reduction in body weight of dams
					Develop	5	20		13% reduction in body weight of male pups
Li et al. 2016									
PFOA									

2. HEALTH EFFECTS

Table 2-3. Levels of Significant Exposure to PFOA – Oral

Figure key ^a	Species (strain) No./group	Exposure parameters	Doses (mg/kg/day)	Parameters monitored	Endpoint	NOAEL (mg/kg/day)	Less serious LOAEL (mg/kg/day)	Serious LOAEL (mg/kg/day)	Effect
47	Rat (CD) 10 M	28 days (G)	0, 0.29, 0.96, 9.6, 29		Bd Wt	0.96	9.6		10% decrease in final body weight
					Hemato	29			
					Hepatic	0.29	29	34% decrease in serum triglyceride levels, minimal hepatocellular hypertrophy at ≥0.29 mg/kg/day; minimal focal necrosis at 29 mg/kg/day	
					Immuno	29			
Loveless et al. 2008									
APFO									
48	Rat (CD) 55 M	13 weeks ad lib (F)	0, 0.06, 0.64, 1.94, 6.5	CS, BW, FI, OW, GN, HP	Bd Wt	6.5			Minimal to moderate hepatocellular hypertrophy at ≥0.64 mg/kg/day No histological alterations No histological alterations
					Resp	6.5			
					Hepatic	6.5			
					Neuro	6.5			
					Repro	6.5			
Perkins et al. 2004									
APFO									
49	Mouse (129S1/SvImJ WT) 17 F	GDs 1–17 (GW)	0, 0.1, 0.3, 0.6, 1, 3, 5, 10, 20	MX, DX, BW	Bd Wt	10 F			Increased absolute and relative liver weight of dams on PND 22 at ≥1 mg/kg/day Significantly reduced pup survival (46%) from birth to weaning
					Hepatic	20			
					Develop	0.3		0.6	
Abbott et al. 2007									
APFO									
Body weight NOAEL is for changes during pregnancy.									
50	Mouse (wild-type Sv/129) 5–6 F	GDs 1–17 1 time/day (GW)	0, 3		Hepatic	3			28% increased liver weight, hepatocellular hypertrophy with increased peroxisomes
					Develop			3	31.5% reduced pups per litter on PND 20
Albrecht et al. 2013									
PFOA									

2. HEALTH EFFECTS

Table 2-3. Levels of Significant Exposure to PFOA – Oral

Figure key ^a	Species (strain) No./group	Exposure parameters	Doses (mg/kg/day)	Parameters monitored	Endpoint	NOAEL (mg/kg/day)	Less serious LOAEL (mg/kg/day)	Serious LOAEL (mg/kg/day)	Effect
51	Mouse (C57BL/6N) 8 F	15 days ad lib (W)	0, 0.94, 1.88, 3.75, 7.5, 15, 30	BW, OW, OF	Bd Wt	7.5		15	Weight loss (~5%)
					Immuno	1.88	3.75	Reduced sRBC-specific response to IgM antibody titers	
DeWitt et al. 2008									
APFO									
52	Mouse (wild-type C57BL/6-Tac and PPAR α knockout) 8 F	15 days (W)	0, 7.5, 30	BW, OW, BC	Bd Wt		30		14–20% decrease in body weight in wild-type mice
					Immuno	7.5	30	16 and 14% reduction in sRBC-specific antibody response in wild-type and PPAR α knockout mice, respectively; 29.8% decrease in relative spleen weight in wild-type mice	
DeWitt et al. 2016									
PFOA									
53	Mouse (C57BL/6N) 8 F	15 days (W)	0, 0.94, 1.88, 3.75, 7.5	BW, OW, BC	Bd Wt	7.5			Decrease in DNP-specific IgM antibody responses; decreases in relative spleen (17%) and thymus weights (14%) at 7.5 mg/kg/day
					Immuno	0.94	1.88		
DeWitt et al. 2016									
PFOA									
54	Mouse (C57BL/6N) 8 F	10, 13, 15 days (W)	0, 3.75, 7.5	BC	Bd Wt	7.5			
DeWitt et al. 2016									
PFOA									

2. HEALTH EFFECTS

Table 2-3. Levels of Significant Exposure to PFOA – Oral

Figure key ^a	Species (strain) No./group	Exposure parameters	Doses (mg/kg/day)	Parameters monitored	Endpoint	NOAEL (mg/kg/day)	Less serious LOAEL (mg/kg/day)	Serious LOAEL (mg/kg/day)	Effect
55	Mouse (CD-1) 6–14 dams; 21–37 F offspring	GDs 1–17 (GW)	0, 0.01, 0.1, 0.3, 1, 5	HP	Hepatic	0.3	1		Increase in severity of chronic inflammation at ≥1 mg/kg/day; Ito cell hypertrophy and centrilobular hepatocellular hypertrophy at 5 mg/kg/day
Filgo et al. 2015a, 2015b									
PFOA									
Animals exposed <i>in utero</i> on GDs 1–17 and examined at 18 months of age; the offspring were also examined by Hines et al. 2009									
56	Mouse (129/Sv WT) 3–7 dams; 6–10 F offspring	GDs 1–17 (GW)	0, 0.1, 0.3, 0.6, 1	HP	Hepatic	1			Increased severity of centrilobular hepatocyte hypertrophy at ≥0.3 mg/kg/day
Filgo et al. 2015a, 2015b									
PFOA									
Animals exposed <i>in utero</i> on GDs 1–17 and examined at 18 months of age; the offspring were also examined by Abbott et al. 2007									
57	Mouse (129/Sv PPARα-knockout) 5–9 dams; 6–10 F offspring	GDs 1–17 (GW)	0, 0.1, 0.3, 1, 3	HP	Hepatic	1	3		Centrilobular hepatocyte hypertrophy and bile duct hyperplasia at 3 mg/kg/day
Filgo et al. 2015a, 2015b									
PFOA									
Animals exposed <i>in utero</i> on GDs 1–17 and examined at 18 months of age; the offspring were also examined by Abbott et al. 2007									
58	Mouse (CD) 40 M,F	28 days ad lib (F)	M: 0, 5.4, 18.0, 54, 180, 540, 1,800, 5,400; F: 0, 5.8, 19.5, 58, 195, 580, 1,950, 5,800	BW, FI, HP	Death Bd Wt Hepatic	 18	 5.4 M	54 M 58 F 5.8 F	4/5 died before end of 4th week 5/5 died before 4th week of study Males: final body weight 20% lower than controls; females: final body weight 25% lower than controls 3-fold or greater increased absolute and relative liver weight and hepatocellular hypertrophy at ≥5.4 mg/kg/day
Griffith and Long 1980									
APFO									

2. HEALTH EFFECTS

Table 2-3. Levels of Significant Exposure to PFOA – Oral

Figure key ^a	Species (strain) No./group	Exposure parameters	Doses (mg/kg/day)	Parameters monitored	Endpoint	NOAEL (mg/kg/day)	Less serious LOAEL (mg/kg/day)	Serious LOAEL (mg/kg/day)	Effect
59	Mouse (CD-1) 5–14F	GDs 1–17 (GW)	0, 0.01, 0.1, 0.3, 1, 3, 5	BW FX	Develop		5 F		Decreased birth weight (approximately 8%) and body weight at weaning (24%)
Hines et al. 2009									
APFO									
60	Mouse (CD-1) 5 M,F	21 days ad lib (F)	0, 0.0018, 0.0054, 0.018, 0.054, 0.18, 0.54, 1.8, 5.4	OW	Hepatic	5.4			39–41% increase in absolute liver weight at ≥5.4 mg/kg/day
Kennedy 1987									
APFO									
61	Mouse (C57BL/6) 6 F	GDs 1–21 (F)	0.3	BW, DX	Develop		0.3 ^b		Altered femur and tibial bone morphology, decreased tibial mineral density
Koskela et al. 2016									
PFOA									
Offspring were examined at 13 and 17 months of age									
62	Mouse (CD-1) 9–45 M	GDs 1–17 1 time/day (GW)	0, 1, 3, 5, 10, 20, 40	MX, DX, BW, OW	Bd Wt	5		10	32% reduced weight gain during pregnancy
					Hepatic	1			38% increase in absolute liver weight at ≥1 mg/kg/day
					Develop		1	5	Reduced ossification of proximal phalanges and advanced preputial separation at ≥1 mg/kg/day; 20% decrease in pup body weight on PND 23 at ≥3 mg/kg/day; increased number of dams with full litter resorptions, decrease in neonatal survival, tail and limb defects, delay in eye opening, and delay in first estrus at ≥5 mg/kg/day
Lau et al. 2006									
APFO									

2. HEALTH EFFECTS

Table 2-3. Levels of Significant Exposure to PFOA – Oral

Figure key ^a	Species (strain) No./group	Exposure parameters	Doses (mg/kg/day)	Parameters monitored	Endpoint	NOAEL (mg/kg/day)	Less serious LOAEL (mg/kg/day)	Serious LOAEL (mg/kg/day)	Effect
63	Mouse (CD) 20 M	28 days (G)	0, 0.29, 0.96, 9.6, 29		Bd Wt Hepatic	0.96 0.29		9.6	Weight loss (86% of controls) Mild hepatocellular hypertrophy at ≥ 0.29 , moderate to severe hypertrophy and single cell necrosis at ≥ 0.96 mg/kg/day; decreased serum cholesterol (31%) and triglyceride (53%) at ≥ 9.6 mg/kg/day
					Immuno	0.96 M	9.6 M		Decreased response to sRBC, decreased number of splenic and thymic lymphocytes
Loveless et al. 2008									
APFO									
64	Mouse (CD-1) 13 F	GDs 1–17 (G)	0, 0.3, 1.0, 3.0	DX	Develop		0.3		Impaired development of mammary glands in offspring
Macon et al. 2011									
PFOA									
65	Mouse (CD-1) 13 F	GDs 10–17 (G)	0, 0.01, 0.1, 1.0	DX	Develop		0.01		Developmental delays in mammary gland development
Macon et al. 2011									
PFOA									
66	Mouse (C57BL/6J-Apc+/+) 20–21 F	GDs 1–17 (GW)	0, 0.01, 0.1, 3.0	BC, BW, FI, HE, OW	Develop	0.1	3		Decrease in number of successful births
Ngo et al. 2014									
PFOA									
67	Mouse (C57BL/6/Bk1) 6 F	GDs 1–21 ad lib (F)	0, 0.3		Develop		0.3 ^b		Increased locomotor activity in adult offspring
Onishchenko et al. 2011									
PFOA									

2. HEALTH EFFECTS

Table 2-3. Levels of Significant Exposure to PFOA – Oral

Figure key ^a	Species (strain) No./group	Exposure parameters	Doses (mg/kg/day)	Parameters monitored	Endpoint	NOAEL (mg/kg/day)	Less serious LOAEL (mg/kg/day)	Serious LOAEL (mg/kg/day)	Effect
68	Mouse (CD-1) 17–21 F dams; 4–6 M,F pups	GDs 1–17 (GW)	0, 0.01, 0.1, 0.3, 1	Bl, BW, HP, OF, OW	Hepatic		0.01		Increased severity of hepatocellular hypertrophy at PND 91 and periportal inflammation on PND 21 at ≥ 0.01 mg/kg/day (incidence was not reported); decreased serum total cholesterol, LDL, and HDL levels in high-fat fasted animals on PND 91 at ≥ 0.3 mg/kg/day
Quist et al. 2015a, 2015b									
PFOA									
Subgroup of female offspring were fed a high-fat diet (50% calories from diet) for 6 weeks									
69	Mouse (C57BL/6) 6 M,F	6 weeks (F)	0.55	BC, BW, FI, OW	Hepatic	0.55			66–67% increase in relative liver weight in males; increased plasma cholesterol levels in males (35%) and females (70%)
Rebholz et al. 2016									
PFOA									
70	Mouse (BALB/c) 6 M,F	6 weeks (F)	0.55	BC, BW, FI, OW	Hepatic	0.55			54–65% increase in relative liver weight; 20% increase in plasma cholesterol in males
Rebholz et al. 2016									
PFOA									
71	Mouse (C57BL/6) 6 F	GD 7 to PND 21 (F)	0, 0.1	BH, BW	Develop		0.1		Increased horizontal and ambulatory locomotor activity and decreased resting time in males; decrease in novel object recognition in males and females
Sobolewski et al. 2014									
PFOA									

2. HEALTH EFFECTS

Table 2-3. Levels of Significant Exposure to PFOA – Oral

Figure key ^a	Species (strain) No./group	Exposure parameters	Doses (mg/kg/day)	Parameters monitored	Endpoint	NOAEL (mg/kg/day)	Less serious LOAEL (mg/kg/day)	Serious LOAEL (mg/kg/day)	Effect
72	Mouse (ICR) 10 M	21 days ad lib (W)	0, 0.5, 2.6, 18, 47	BW, OW, GN, HP	Bd Wt	2.6		18	17% decrease in weight gain 27% increase in relative liver weight at ≥ 0.5 mg/kg/day; increases in ALT at ≥ 2.6 mg/kg/day; hepatocytomegaly at 18 mg/kg/day; necrosis at 47 mg/kg/day
					Hepatic	18	47		
					Renal	47			
Son et al. 2008									
APFO									
73	Mouse (ICR) 10 M	21 days (W)	0, 0.49, 2.64, 17.63, 47.21	FX HP	Immuno		47.21		Marked hyperplasia in spleen white pulp and thymic atrophy
Son et al. 2009									
PFOA									
74	Mouse (C57BL/6N) 7–8 M	3 weeks (F)	0, 5	HP	Hepatic		5		Hepatocellular hypertrophy and degeneration
Tan et al. 2013									
PFOA									
75	Mouse (CD-1) 4–12 F	GDs 1–17 (GW)	0, 0.01, 0.1, 0.3, 1.0	BW, DX, OW	Develop		0.01		Developmental delays in the mammary glands on PNDs 35 (26%) and 56 (30%)
Tucker et al. 2015									
PFOA									
76	Mouse (C57BL/6) 2–6 F	GDs 1–17 (GW)	0, 0.01, 0.1, 0.3, 1.0	BW, DX, OW	Develop	0.1	0.3		Developmental delays in the mammary glands on PNDs 21 (38%) and 61 (25%)
Tucker et al. 2015									
PFOA									

2. HEALTH EFFECTS

Table 2-3. Levels of Significant Exposure to PFOA – Oral

Figure key ^a	Species (strain) No./group	Exposure parameters	Doses (mg/kg/day)	Parameters monitored	Endpoint	NOAEL (mg/kg/day)	Less serious LOAEL (mg/kg/day)	Serious LOAEL (mg/kg/day)	Effect
77	Mouse (CD-1) 14–16 F	GDs 1–17 GDs 8–17 1 time/day GDs 12–17 (GW)	0, 5	MX, DX, GN, HP	Repro		5		Delayed mammary gland differentiation
White et al. 2007									
APFO									
78	Mouse (CD-1) 14 F	GDs 1–17 1 time/day (GW)	0, 5	DX, GN	Develop			5	Increased prenatal loss; 40% reduced neonatal body weight on PNDs 5 and 10
White et al. 2007									
APFO									
79	Mouse (CD-1) 28–48 F	GDs 1–17 1 time/day (GW)	0, 3, 5		Develop		3		Delayed mammary gland development in female pups on PNDs 22–63 and at 18 months
White et al. 2009									
APFO									
80	Mouse (CD-1) 10–12 F	GDs 1–17 1 time/day (GW)	0, 1, 5		Repro		1		Delayed mammary gland lactational differentiation in dams on PND 22
					Develop	1		5	323% increased prenatal loss, 16.7% decreased live fetuses, 24.3% decreased neonatal survival
White et al. 2011									
APFO									
81	Mouse (CD-1) 10–12 F	GDs 1–17 1 time/day (GW) GD 7 to PND 22 (W); 3-generation study	0, 0.0024, 1.0024		Repro		0.0024		Delayed mammary gland lactational differentiation in dams on PND 22
					Develop		0.0024		Delayed mammary gland development in female pups on PNDs 22–63
White et al. 2011									
APFO									

2. HEALTH EFFECTS

Table 2-3. Levels of Significant Exposure to PFOA – Oral

Figure key ^a	Species (strain) No./group	Exposure parameters	Doses (mg/kg/day)	Parameters monitored	Endpoint	NOAEL (mg/kg/day)	Less serious LOAEL (mg/kg/day)	Serious LOAEL (mg/kg/day)	Effect
82	Mouse (CD-1) 28–48 F	GDs 1–17 1 time/day (GW)	0, 3, 5	CS, BW, MX, DX, OW	Bd Wt	5			Significant increase in relative and absolute maternal liver weight on PND 22 at ≥3 mg/kg/day 3 mg/kg/day: reduced weight gain through lactation (14.8% in males and 20.6% in females); delayed eye opening and hair growth at ≥3 mg/kg/day; decreased pup survival from birth to weaning at 5 mg/kg/day
					Hepatic	5			
					Develop		3	5	
Wolf et al. 2007									
APFO									
83	Mouse (ICR) 5–10 F	GDs 0–17 or 0, 1, 5, 10 GDs 0–18 (GW)		BW, FI, WI, OW, HP, DX	Hepatic	1	10		35% increased maternal relative liver weight with hepatocellular hypertrophy at ≥1 mg/kg/day; single cell necrosis and mild calcification at 10 mg/kg/day 35% increased maternal relative kidney weight with renal hypertrophy 14% increased neonatal mortality, 9.5% reduced fetal body weight
					Renal	1			
					Develop	1		5	
Yahia et al. 2010									
PFOA									

2. HEALTH EFFECTS

Table 2-3. Levels of Significant Exposure to PFOA – Oral

Figure key ^a	Species (strain) No./group	Exposure parameters	Doses (mg/kg/day)	Parameters monitored	Endpoint	NOAEL (mg/kg/day)	Less serious LOAEL (mg/kg/day)	Serious LOAEL (mg/kg/day)	Effect
CHRONIC EXPOSURE									
84	Rat (Sprague-Dawley) 65 M,F	2 years ad lib (F)	0, 1.5, 15	CS, FI, BW, OW, HE, BI, GN, HP	Bd Wt Resp Cardio Gastro Hemato Hepatic Renal Ocular Endocr Immuno Neuro Repro Other noncancer Cancer	1.5 F 1.5 M 15 15 15 1.5 15 15 15 15 1.5 M	15 F 15 15 M 1.5 F 1.5 M	15 M	10.3% lower terminal body weight Lung hemorrhage Increased serum ALT and AST and hepatocellular hypertrophy at ≥ 1.5 mg/kg/day; hepatocellular necrosis at 15 mg/kg/day after 1 year of exposure Vascular mineralization in the testes Tubular hyperplasia in the ovaries Inflammation of the salivary gland No significant increases in the incidence of neoplastic lesions
3M 1983 PFOA									

2. HEALTH EFFECTS

Table 2-3. Levels of Significant Exposure to PFOA – Oral

Figure key ^a	Species (strain) No./group	Exposure parameters	Doses (mg/kg/day)	Parameters monitored	Endpoint	NOAEL (mg/kg/day)	Less serious LOAEL (mg/kg/day)	Serious LOAEL (mg/kg/day)	Effect
85	Rat (CD) 156 M	2 years ad lib (F)	0, 13.6	CS, BW, FI, OW, GN, HP	Bd Wt		13.6		>10% reduction in weight gain most of the study
					Hepatic	13.6			Increased relative liver weight
					Repro		13.6		Increased incidence of Leydig cell hyperplasia; elevated serum LH at 18 months
					Other noncancer		13.6		Increased incidence of acinar cell hyperplasia in pancreas
					Cancer				No significant increases in the incidence of neoplastic lesions

Biegel et al. 2001
APFO

^aThe number corresponds to entries in Figure 2-6.

^bUsed to derive an intermediate-duration oral MRL of 3x10⁻⁶ mg/kg/day based on the predicted TWA serum PFOA level of 8.29 µg/mL at the LOAEL dose and an empirical clearance model to estimate a HED. The LOAEL_{HED} of 0.000821 mg/kg/day was divided by an uncertainty factor of 300 (10 for the use of a LOAEL, 3 for extrapolation from animals to humans with dosimetric adjustment, and 10 for human variability).

ALT = alanine aminotransferase; APFO = ammonium perfluorooctanoate (ammonium salt of PFOA); AST = aspartate aminotransferase; BC = biochemistry; BI = biochemical changes; BW or Bd wt = body weight; C = capsule; Cardio = cardiovascular; CS = clinical signs; Develop = developmental; DW = drinking water; DX = developmental toxicity; EA = enzyme activity; Endocr = endocrine; (F) = feed; F = female(s); FI = food intake; FT4 = free thyroxine; FX = fetal toxicity; G = gavage; Gastro = gastrointestinal; GD = gestation day; GN = gross necropsy; GO = gavage in oil vehicle; GW = gavage in water vehicle; HDL = high-density lipoprotein; HE or Hemato = hematology; HED = human equivalent dose; HP = histopathology; Immuno = immunotoxicological; LD₅₀ = lethal dose, 50% kill; LE = lethality; LDL = low-density lipoprotein; LH = luteinizing hormone; LOAEL = lowest-observed-adverse-effect level; M = male(s); MRL = Minimal Risk Level; Musc/skel = musculoskeletal; MX = maternal toxicity; Neuro = neurological; NK = natural killer; NOAEL = no observed-adverse-effect level; OF = organ function; OP = ophthalmology; OW = organ weight; PFOA = perfluorooctanoic acid; PND = postnatal day; PPARα = peroxisome proliferator-activated receptor-α; Repro = reproductive; Resp = respiratory; sRBC = sheep red blood cell; TSH = thyroid-stimulating hormone; TT4 = total thyroxine; TWA = time-weighted average; UR = urinalysis; W = water; WI = water intake

2. HEALTH EFFECTS

Figure 2-6. Levels of Significant Exposure to PFOA – Oral Acute (≤14 days)

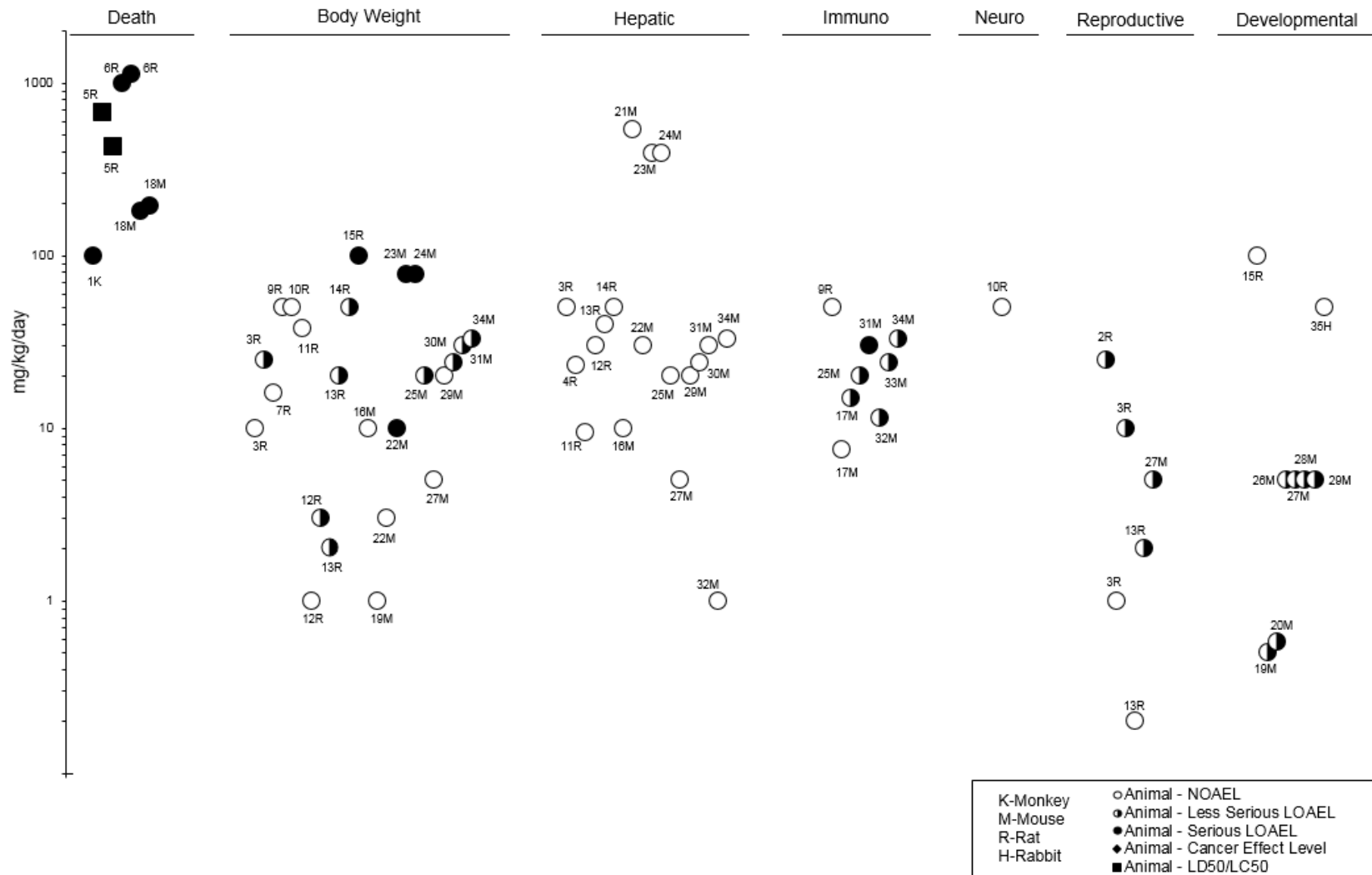

2. HEALTH EFFECTS

Figure 2-6. Levels of Significant Exposure to PFOA – Oral Intermediate (15–364 days)

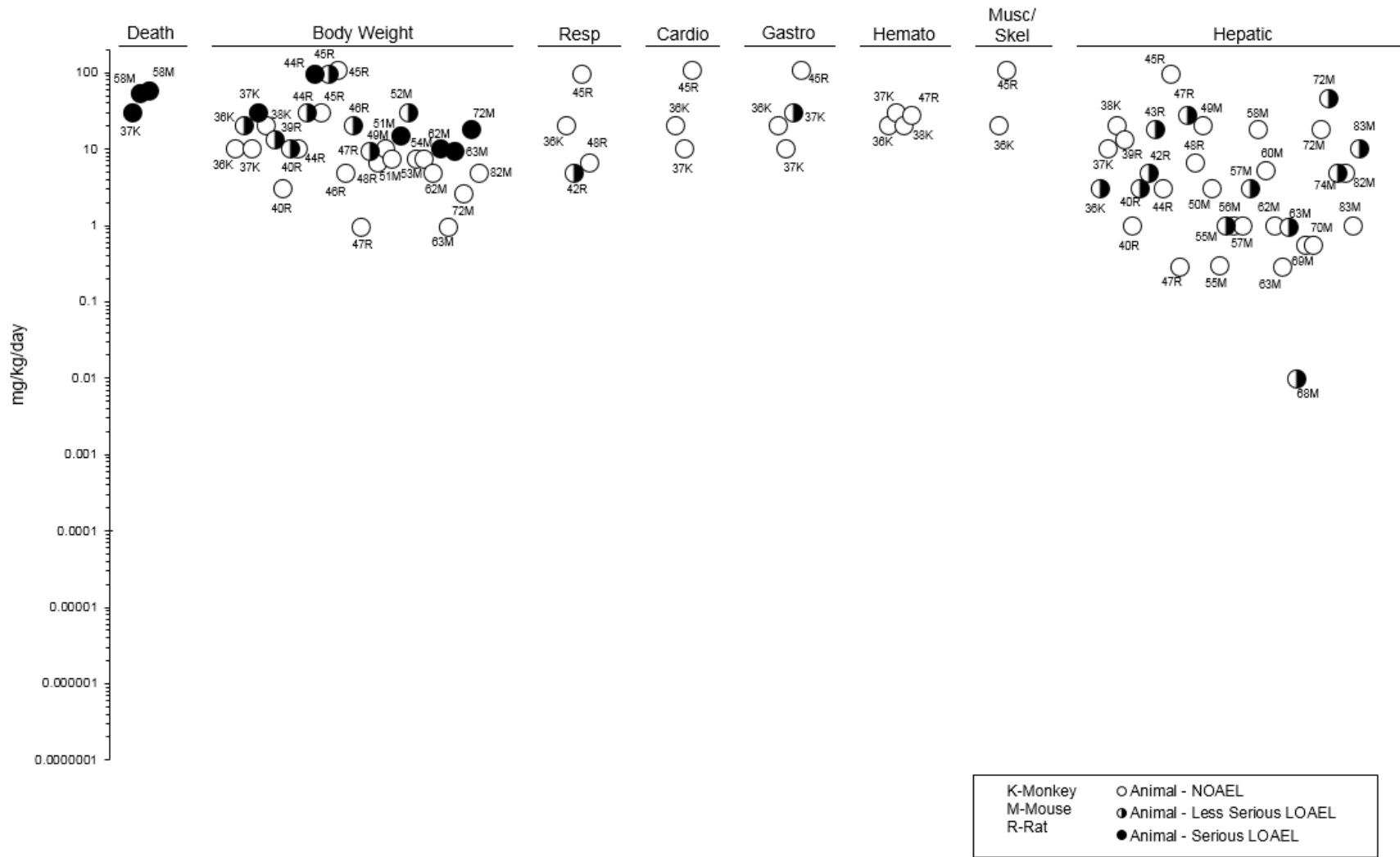

2. HEALTH EFFECTS

Figure 2-6. Levels of Significant Exposure to PFOA – Oral Intermediate (15–364 days)

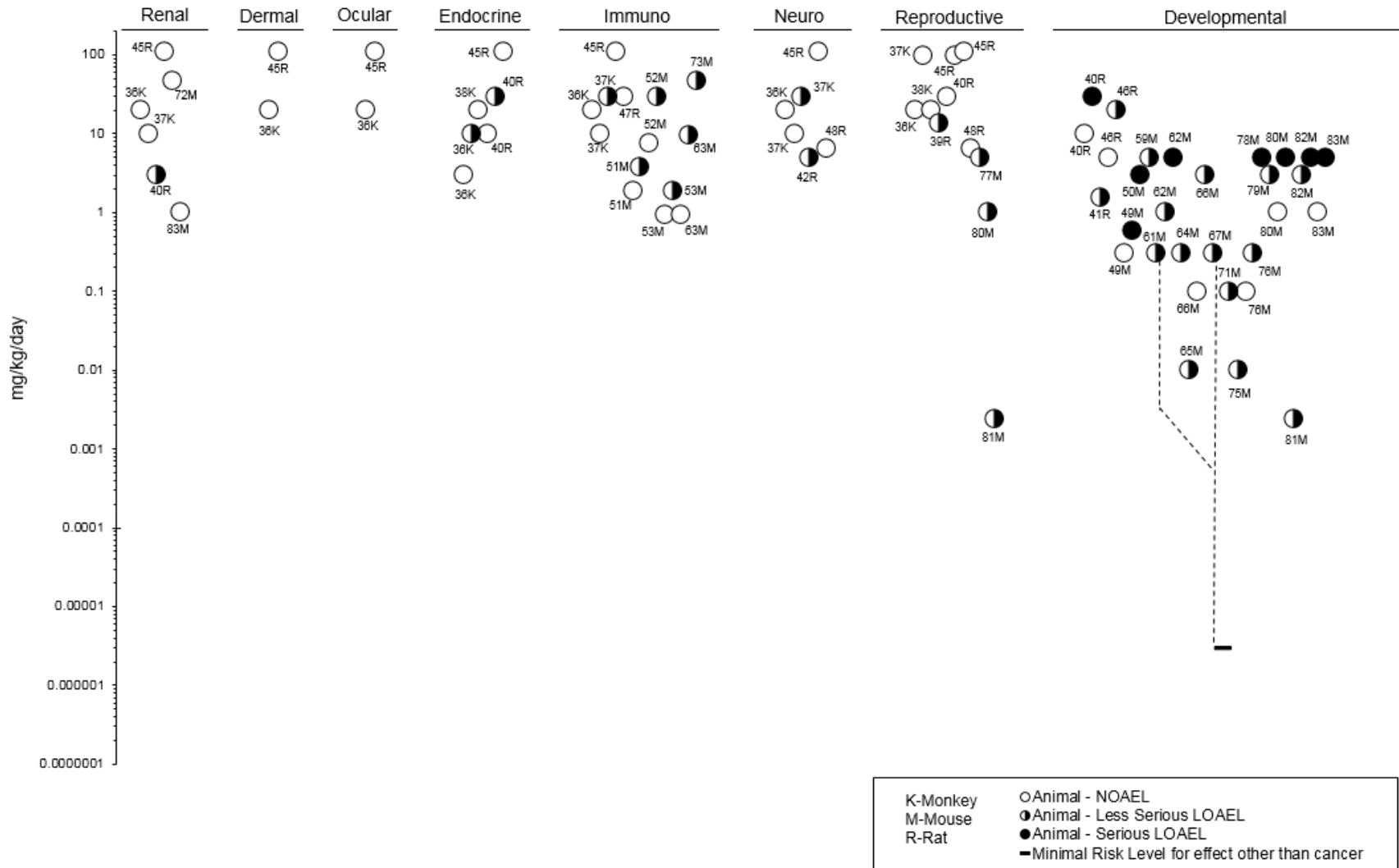

2. HEALTH EFFECTS

**Figure 2-6. Levels of Significant Exposure to PFOA – Oral
Chronic (≥365 days)**

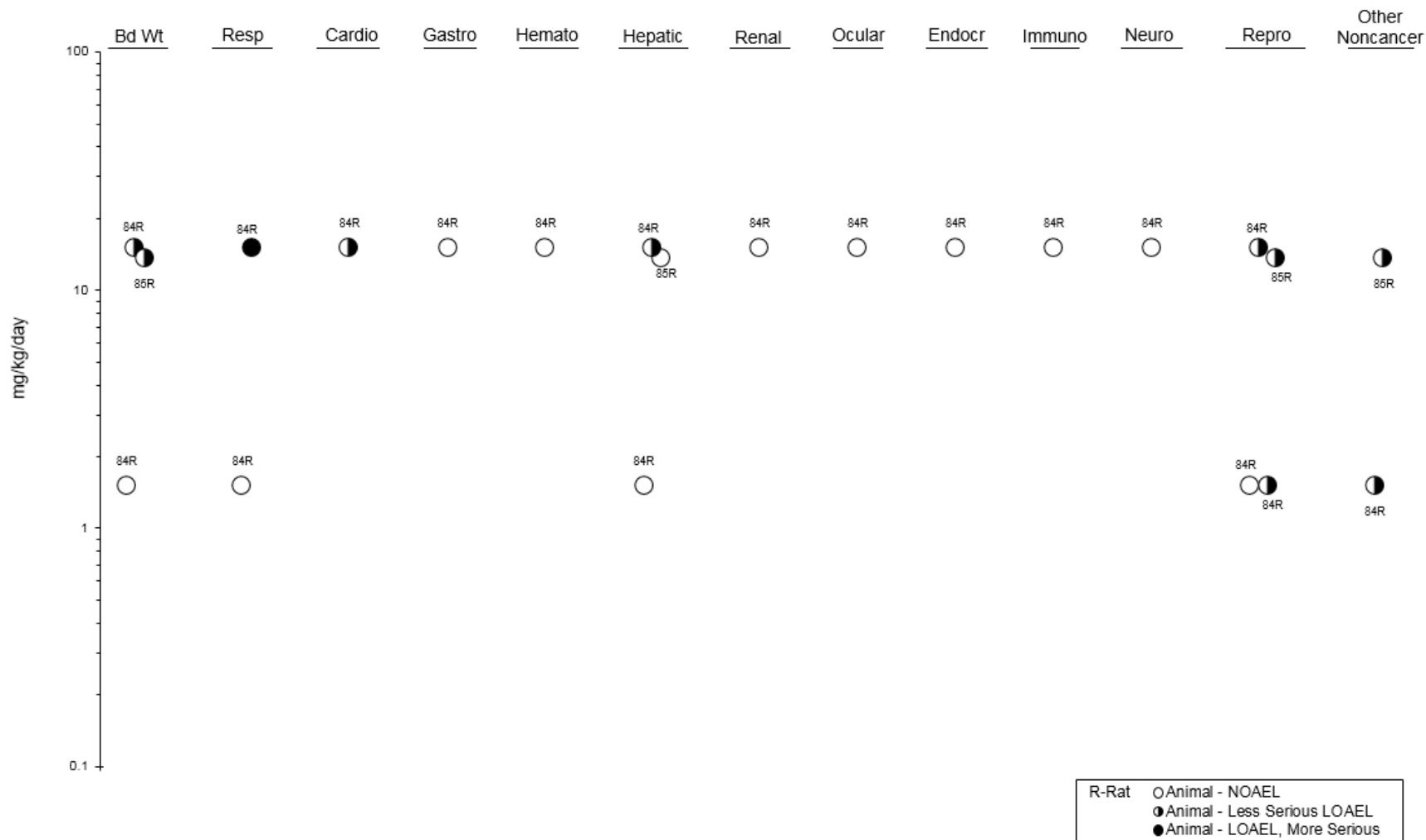

2. HEALTH EFFECTS

Table 2-4. Levels of Significant Exposure to PFOS – Oral

Figure key ^a	Species (strain) No./group	Exposure parameters	Doses (mg/kg/day)	Parameters monitored	Endpoint	NOAEL (mg/kg/day)	Less serious LOAEL (mg/kg/day)	Serious LOAEL (mg/kg/day)	Effect
ACUTE EXPOSURE									
1	Rat (Sprague-Dawley) 5–15 F	Once (GW)	0, 15	BI, OF	Endocr		15		Transient decrease in serum TT4 (24, 38, and 53% after 2, 6, and 24 hours, respectively)
Chang et al. 2008b									
PFOS potassium salt									
2	Rat (Sprague-Dawley) 30 M	1 day (F)	0, 1.97, 10.3	HP	Hepatic Endocr	10.3 10.3			
Elcombe et al. 2012a									
PFOS potassium salt									
3	Rat (Sprague-Dawley) 30 M	7 day (F)	0, 0, 1.72, 8.17	HP	Hepatic Endocr	8.17 8.17			Decreased serum cholesterol (38%) and triglyceride (55%) levels at 8.17 mg/kg/day
Elcombe et al. 2012a									
PFOS potassium salt									
4	Rat (Sprague-Dawley) 10 M	7 day (F)	0, 1.79, 8.96	HP	Hepatic Endocr	8.96 8.96			Hepatocellular hypertrophy, incr liver weight, decreased serum cholesterol at ≥1.79 mg/kg/day
Elcombe et al. 2012b									
PFOS potassium salt									
5	Rat (Sprague-Dawley) NS F	2 day GDs 19–20 1 x/d (GW)	0, 25, 50	BW, MX, DX	Develop			25	Decreased neonatal survival (82% of controls on PND 1)
Grasty et al. 2003									
PFOS potassium salt									

2. HEALTH EFFECTS

Table 2-4. Levels of Significant Exposure to PFOS – Oral

Figure key ^a	Species (strain) No./group	Exposure parameters	Doses (mg/kg/day)	Parameters monitored	Endpoint	NOAEL (mg/kg/day)	Less serious LOAEL (mg/kg/day)	Serious LOAEL (mg/kg/day)	Effect
6	Rat (Sprague-Dawley) NS F	4 days GDs 2–5, 6–9, 10–13, 14–17, or 17–20 (GW)	0, 25	MX, DX	Bd Wt			25	Weight loss during treatment when treated on GDs 2–5 (22%) or 6–9 (17%)
					Develop			25	Decreased neonatal survival (90% survival on GDs 2–5; 30% survival on GDs 17–20)
Grasty et al. 2003									
PFOS potassium salt									
7	Rat (Sprague-Dawley) NS F	2 days GDs 19–20	0, 25, 50		Develop			25	Increased neonatal mortality
Grasty et al. 2005									
PFOS potassium salt									
8	Rat (Wistar) 8 M	7 days ad lib (F)	0, 15	BW, OW, BI, EA	Hepatic	15			40% increase in absolute liver weight
Haughom and Spydevold 1992									
PFOS potassium salt									
9	Mouse (wild-type 129S1/SvIm) 8–20 F	GDs 15–18 1 time/day (GW)	0, 4.5, 6.5, 8.5, 10.5	DX	Develop			4.5	31% reduced percentage of live pups per litter on PND 15
Abbott et al. 2009									
PFOS potassium salt									
10	Mouse (ICR) 5–7 F	GDs 11–15 1 time/day (GW)	0, 50	BW, OW, DX	Hepatic	50			103% increased maternal relative liver weight
					Develop		50	6.1% increased cleft palate and 12.7% reduced body weight in fetuses	
Era et al. 2009									
PFOS potassium salt									

2. HEALTH EFFECTS

Table 2-4. Levels of Significant Exposure to PFOS – Oral

Figure key ^a	Species (strain) No./group	Exposure parameters	Doses (mg/kg/day)	Parameters monitored	Endpoint	NOAEL (mg/kg/day)	Less serious LOAEL (mg/kg/day)	Serious LOAEL (mg/kg/day)	Effect
11	Mouse (CD-1) 10–11 F	GDs 6–18 1 time/day (GW)	0, 1.5, 3, 6	MX, DX, BW, CS, OW	Bd Wt	6			21% increase in absolute liver weight at ≥3 mg/kg/day No alterations in serum T3 or T4 levels
					Hepatic	6			
					Endocr Develop	6 6			
Fuentes et al. 2006									
PFOS potassium salt									
12	Mouse (CD-1) 8–10 F	GDs 12–18 (GW)	0, 6	CS, BW, BH, MX, DX	Bd Wt Develop	6	6		Reduced body weight of pups on PNDs 4 and 8
Fuentes et al. 2007b									
PFOS potassium salt									
13	Mouse (CD-1) 8–10 F	GDs 12–18 (GW)	0, 6	DX	Develop		6		Decreased distanced traveled in open field test at 3 months of age
Fuentes et al. 2007a									
PFOS potassium salt									
14	Mouse (NMRI) 12 M pups	Single dose (GO)	0, 11.3	BH, BW, OF	Develop		11.3		Altered spontaneous behavior (≤60, 87.5, or 60% changes in total activity, rearing, and locomotion)
Hallgren et al. 2015									
PFOS									
15	Mouse (CD-1) 10 M pups	Once (G)	0, 0.75, 11.3	CS, OF, DX	Develop		0.75 M		24% decreased total spontaneous activity at 2 months of age; no significant alteration at 4 months
Johansson et al. 2008									
PFOS potassium salt									

2. HEALTH EFFECTS

Table 2-4. Levels of Significant Exposure to PFOS – Oral

Figure key ^a	Species (strain) No./group	Exposure parameters	Doses (mg/kg/day)	Parameters monitored	Endpoint	NOAEL (mg/kg/day)	Less serious LOAEL (mg/kg/day)	Serious LOAEL (mg/kg/day)	Effect
16	Mouse (CD-1) 10 F	GDs 11–16 (G)	0, 0.5, 2.0, 8.0	BC, BW, DX, HP	Bd Wt		8.0		21% reduction in maternal body weight gain on GDs 14–17
					Repro		0.5		Decreases in mean fetal placental weight and placental capacity
					Develop		0.5	2.0	Post-implantation losses at ≥0.5 mg/kg/day; 24 and 35% reduction fetal body weight and 31 and 52% reduction in the number of live fetuses at 2.0 and 8.0 mg/kg/day
Lee et al. 2015a									
PFOS									
17	Mouse (BALB/c) 5 F	7 days (GW)	20	BW, OW, BC	Bd Wt		20		41% decrease body weight gain
					Hepatic	20		59% increase in relative liver weight	
					Immuno		20		Inhibition of T lymphocyte proliferation in response to sRBC; decreased phagocytosis by peripheral blood cells and NK cell activity; decreased IgM antibody formation in response to OVA
Vetvicka and Vetvickova 2013									
PFOS									
18	Mouse (CD-1) 4 M	14 days 1 time/day (GO)	0, 1, 5, 10		Bd Wt	10			~70% increased absolute liver weight at ≥5 mg/kg/day
					Hepatic	10			
					Repro	10			
Wan et al. 2011									
PFOS potassium salt									
19	Mouse (C57BL/6) 10 M	1 day (GO)	0, 300, 400, 500, 600, 700 LE	BW, CS, HP, LE	Death			579	LD ₅₀
Xing et al. 2016									
PFOS									

2. HEALTH EFFECTS

Table 2-4. Levels of Significant Exposure to PFOS – Oral

Figure key ^a	Species (strain) No./group	Exposure parameters	Doses (mg/kg/day)	Parameters monitored	Endpoint	NOAEL (mg/kg/day)	Less serious LOAEL (mg/kg/day)	Serious LOAEL (mg/kg/day)	Effect
20	Mouse (C57BL/6N) 12 M	7 days (G)	0, 5, 20, 40	FX	Immuno		5		Impaired response to T-cell mitogens; suppressed response to sRBC
Zheng et al. 2009									
PFOS									
21	Rabbit (New Zealand) 22 F	GDs 6–20 1 time/day (GW)	0, 0.1, 1.0, 2.5, 3.75	MX, DX, BW, CS	Bd wt	0.1		1 F	21% decreased mean maternal body weight gain on GDs 7–21; no effect on food consumption
					Develop	1	2.5	3.75	Decreased fetal body weight; 10% at 2.5 mg/kg/day and 24% at 3.75 mg/kg/day; 10/22 does aborted between GD 22 and 28 at 3.75 mg/kg/day
Case et al. 2001									
PFOS potassium salt									
INTERMEDIATE									
22	Monkey (Cynomolgus) 4–6 M, 4–6 F	26 weeks 1 time/day (C)	0, 0.03, 0.15, 0.75	CS, BW, OW, HE, BI, GN, HP	Bd Wt	0.15 M 0.75 F	0.75 M		13.5% reduction in final body weight
					Resp	0.75			
					Cardio	0.75			
					Gastro	0.75			
					Hemato	0.75			
					Musc/skel	0.75			
					Hepatic	0.15	0.75		47–55% increased absolute liver weight; 50–60% decreased serum cholesterol; hepatocellular hypertrophy, mild bile stasis, and lipid vacuolation at 0.75 mg/kg/day
					Renal	0.75			
					Dermal	0.75			

2. HEALTH EFFECTS

Table 2-4. Levels of Significant Exposure to PFOS – Oral

Figure key ^a	Species (strain) No./group	Exposure parameters	Doses (mg/kg/day)	Parameters monitored	Endpoint	NOAEL (mg/kg/day)	Less serious LOAEL (mg/kg/day)	Serious LOAEL (mg/kg/day)	Effect
					Ocular	0.75			
					Endocr	0.15	0.75		Increased TSH and decreased total T3
					Immuno	0.75			
					Neuro	0.75			No histological alterations
					Repro	0.15	0.75 M		Significant decrease in serum estradiol on days 62 (48%), 91 (42%), and 182 (96%); no histological alterations
Seacat et al. 2002									
PFOS potassium salt									
23	Monkey (Cynomolgus) 6 M,F	4 weeks 1 time/day (C)	0, 0.02, 2	CS, BW, FC, HE, BI, GN, HP, EA	Bd Wt Resp Hemato Hepatic Renal Ocular Endocr Immuno Repro	2 2 2 2 2 2 2 2 2			No histological alteration No histological alterations
Thomford 2002a									
PFOS potassium salt									
24	Rat (Sprague-Dawley) 25 F	GD 0 to PND 20 1 time/day (GW)	0, 0.1, 0.3, 1		Repro Develop	1 0.3	1		~30% increased locomotor activity and concurrent failure to habituate to test environment in male pups on PND 17
Butenhoff et al. 2009b									
PFOS potassium salt									
25	Rat (Sprague-Dawley) 25 F	GD 0 to PND 20 1 time/day (GW)	0, 0.1, 0.3, 1		Develop		1		2.1-fold increased fetal thyroid cell proliferation on GD 20
Chang et al. 2009									
PFOS potassium salt									

2. HEALTH EFFECTS

Table 2-4. Levels of Significant Exposure to PFOS – Oral

Figure key ^a	Species (strain) No./group	Exposure parameters	Doses (mg/kg/day)	Parameters monitored	Endpoint	NOAEL (mg/kg/day)	Less serious LOAEL (mg/kg/day)	Serious LOAEL (mg/kg/day)	Effect
26	Rat (Sprague-Dawley) 10 F	GDs 1–21 1 time/day (GW)	0, 0.1, 2		Develop	0.1		2	~5-fold increased postnatal mortality and severe lung histopathology in pups
Chen et al. 2012b									
PFOS									
27	Rat (Sprague-Dawley) 10 M	Daily 28 days (G)	0, 5, 20	HP	Death Resp Hepatic Neuro		5 5 5	20	100% by day 26 Pulmonary congestion Hepatocellular hypertrophy and focal necrosis at ≥5 mg/kg/day; fatty degeneration at 20 mg/kg/day Cachexia and lethargy
Cui et al. 2009									
PFOS									
28	Rat (Sprague-Dawley) 15M, 15F	Daily 28 days (F)	M: 0, 0.13, 1.23, 2.98, 5.89 F: 0, 0.14, 1.33, 3.47, 7.01		Cardio Hemato Hepatic Renal Endocr	5.89 M 3.47 F 5.89 M 5.89 M 0.14		7.01 F	Decreased red blood cells (8.9%), hemoglobin (10%), hematocrit (8.8%) Increased relative liver weight; hepatocellular hypertrophy in males at 5.89 mg/kg/day Decreased T4 level (82% in males; 48% in females)
Curran et al. 2008									
PFOS potassium salt									
29	Rat (Sprague-Dawley) 30 M	28 days (F)	0, 1.54, 7.34	HP	Hepatic Endocr	7.34 7.34			Hepatocellular hypertrophy and decreased serum cholesterol levels at ≥1.54 mg/kg/day
Elcombe et al. 2012a									
PFOS potassium salt									

2. HEALTH EFFECTS

Table 2-4. Levels of Significant Exposure to PFOS – Oral

Figure key ^a	Species (strain) No./group	Exposure parameters	Doses (mg/kg/day)	Parameters monitored	Endpoint	NOAEL (mg/kg/day)	Less serious LOAEL (mg/kg/day)	Serious LOAEL (mg/kg/day)	Effect
30	Rat (Wistar) 5–6 M	Daily 28 days (G)	0, 0.12, 0.5, 2.0, 8.5	FX	Neuro	2	8.5		Tonic convulsions in response to stimuli
Kawamoto et al. 2011									
PFOS									
31	Rat (Sprague-Dawley) NS	GDs 2–21 (GW)	0, 1, 2, 3, 5, 10		Develop	1		2	Reduced serum T4 in pups at 1 mg/kg/day; approximately 60% survival at weaning versus 80% in controls at 2 mg/kg/day
Lau et al. 2003									
PFOS potassium salt									
32	Rat (Sprague-Dawley) 15M, 15F	28 days (F)	M: 0, 0.14, 1.33, 3.21, 6.34; F: 0, 0.15, 1.43, 3.73, 7.58	OW, BW	Bd Wt Hepatic Immuno	1.33 M 6.34 M 6.34 M	3.21 M		12% decrease in terminal body weight Increased relative liver weight at ≥0.14 mg/kg/day
Lefebvre et al. 2008									
PFOS									
33	Rat (Sprague-Dawley) 19 M	28 days (GO)	0, 0.5, 1.0, 3.0, 6.0	BC, BW, HP, OF, OW	Neuro Repro	0.5 0.5	1 1		Degeneration of gonadotropic cells of the pituitary gland at ≥1.0 mg/kg/day; dense chromatin, condensed ribosomes, loss of morphology in the hypothalamus at ≥3.0 mg/kg/day Loss/degeneration of spermatozooids, marked edema in the testes
Lopez-Doval et al. 2014									
PFOS									

2. HEALTH EFFECTS

Table 2-4. Levels of Significant Exposure to PFOS – Oral

Figure key ^a	Species (strain) No./group	Exposure parameters	Doses (mg/kg/day)	Parameters monitored	Endpoint	NOAEL (mg/kg/day)	Less serious LOAEL (mg/kg/day)	Serious LOAEL (mg/kg/day)	Effect
34	Rat (Sprague-Dawley) 35 M,F	84 days (6 weeks prior to mating GD 0 to PND 21) 1 time/day (GW)	0, 0.1, 0.4, 1.6, 3.2	MX, DX, BW, OW, OF, GN, HP, FC	Bd Wt	1.6	3.2		>10% reduction in body weight
					Repro	3.2		No alterations in mating and fertility parameters	
					Develop	0.1 ^b	0.4	1.6	Delayed eye opening and transient decrease in F2 pup body weight (13%) on LDs 7–14 at ≥0.4 mg/kg/day; decreased pup survival to postpartum day 21 at ≥1.6 mg/kg/day
Luebker et al. 2005a									
PFOS potassium salt									
35	Rat (Sprague-Dawley) 50 F	90 day 1 time/day	0, 1.6	MX, DX, BW, OW, OF, GN		Develop		1.6	Increased pup mortality during PNDs 1–4
Luebker et al. 2005a									
PFOS potassium salt									
Cross-foster study									
36	Rat (Sprague-Dawley) 20 F	62–67 days 42 days prior to mating through GD 20 or PND 4 (G)	0, 0.4, 0.8, 1, 1.2, 1.6, 2	MX, DX, BW, CS, BI	Bd Wt	1.6	2		22% reduction in body weight gain during pre-mating; food consumption reduced 5.8%
					Hepatic	2		16% reduction in serum total cholesterol on PND 5 at ≥0.4 mg/kg/day Increased liver weight in dams at ≥0.8 mg/kg/day;	
					Endocr		0.4	46% reduction in total T4 on PND 5	
					Repro	2		No alteration in fertility	
Develop		0.4	1.6	>10% decrease in mean pup weight per litter on PND 5 at ≥0.4 mg/kg/day; ~50% decrease mean pup survival per litter on PND 5 at ≥1.6 mg/kg/day					
Luebker et al. 2005b									
PFOS potassium salt									

2. HEALTH EFFECTS

Table 2-4. Levels of Significant Exposure to PFOS – Oral

Figure key ^a	Species (strain) No./group	Exposure parameters	Doses (mg/kg/day)	Parameters monitored	Endpoint	NOAEL (mg/kg/day)	Less serious LOAEL (mg/kg/day)	Serious LOAEL (mg/kg/day)	Effect
37	Rat (Sprague-Dawley) 10 M	25 days (GW)	0, 0.5, 1.0, 3.0 and 6.0	OF, OW	Endocr		0.5		Decreases in serum corticosterone (~58%) and ACTH levels (~11%), decrease in corticotrophin releasing hormone levels in hypothalamus (~8%); decrease in relative adrenal weight (~43%),
Pereiro et al. 2014									
PFOS									
38	Rat (Sprague-Dawley) 21 dams; 10–12 M,F pups/litter	GDs 2–6 (G)	0, 18.75	BW, OF, OW	Bd Wt		18.75		Reduced body weight in dams; approximately 98% on GD 8 and 33% on GD 20
					Develop		18.75		Decreased birth weight in females only (approximately 11%); increased systolic blood pressure in male offspring at 7 and 52 weeks and in female offspring at 37 and 65 weeks; reduced nephron endowment
Rogers et al. 2014									
PFOS									
39	Rat (Sprague-Dawley) 7 M	28 days (GW)	0, 3.0, and 6.0	Bl, BW, OW	Bd Wt Endocr	6		3	Decreased serum prolactin (~78%) and estradiol concentrations (~18%)
Salgado et al. 2015									
PFOS									

2. HEALTH EFFECTS

Table 2-4. Levels of Significant Exposure to PFOS – Oral

Figure key ^a	Species (strain) No./group	Exposure parameters	Doses (mg/kg/day)	Parameters monitored	Endpoint	NOAEL (mg/kg/day)	Less serious LOAEL (mg/kg/day)	Serious LOAEL (mg/kg/day)	Effect
40	Rat (Sprague-Dawley) 25 M,F	4 weeks ad lib (F)	M: 0, 0.05, 0.18, 0.37, 1.51; F: 0, 0.05, 0.22, 0.47, 1.77	CS, CO, OW, HE, BI, GN, HP	Bd Wt	1.77 F			
					Hemato	1.77 F			
					Hepatic	1.77 F			
					Renal	1.77 F			
					Ocular	1.77 F			
					Immuno	1.77 F		No histological alterations	
					Neuro	1.77 F		No histological alterations	
					Repro	1.51 M 1.77 F		No histological alterations	
Seacat et al. 2003									
PFOS potassium salt									
41	Rat (Sprague-Dawley) 25 M,F	14 weeks ad lib (F)	M:0, 0.03, 0.13, 0.34, 1.33; F:0, 0.04, 0.15, 0.4, 1.56	CS, CO, OW, HE, BI, GN, HP	Bd Wt	1.56 F			
					Hemato	0.34 M	1.33 M	45% increase in non-segmented neutrophils	
					Hepatic	1.33 M		Increased absolute and relative liver weight; increased serum ALT; hepatocyte hypertrophy and vacuolation at 1.33/1.55 mg/kg/day	
					Renal	1.56 F			
					Ocular	1.56 F			
					Endocr	1.56 F			
					Immuno	1.56 F		No histological alterations	
					Neuro	1.56 F		No histological alterations	
Repro	1.33 M 1.56 F		No histological alterations						
Seacat et al. 2003									
PFOS potassium salt									

2. HEALTH EFFECTS

Table 2-4. Levels of Significant Exposure to PFOS – Oral

Figure key ^a	Species (strain) No./group	Exposure parameters	Doses (mg/kg/day)	Parameters monitored	Endpoint	NOAEL (mg/kg/day)	Less serious LOAEL (mg/kg/day)	Serious LOAEL (mg/kg/day)	Effect
42	Rat (Sprague-Dawley) 25–50 F	GDs 2–20 (GW)	0, 1, 2, 3, 5, 10	MX, DX, BW, FI, WI, OW, BI	Bd Wt	1	2		Decreased mean body weight gain, 10% at 2 mg/kg/day and 33% at 5 mg/kg/day
					Hepatic	10			
					Endocr		1		Reduced total and free T4 and T3
					Develop		10		Increased incidences of cleft palate
Thibodeaux et al. 2003									
PFOS potassium salt									
43	Rat (Wistar) 10 or 15 dams; 6–10 M,F pups	GD 1 to PND 1, PNDs 1–7 or 35, or GD 1 to PND 7 or 35	0, 0.8, 2.4	DX	Develop		0.8		Decreased spatial learning ability in prenatally or postnatally exposed offspring at ≥0.8 mg/kg/day and in offspring exposure pre- and postnatally at 2.4 mg/kg/day; decreased memory ability in offspring exposure pre- and postnatally at 2.4 mg/kg/day
Wang et al. 2015c									
PFOS									
44	Rat (Sprague-Dawley) 10 F	GDs 2–21 1 time/day (GW)	0, 0.1, 0.6, 2		Develop	0.6		2	5-fold increased neonatal mortality on PNDs 1–3
Xia et al. 2011									
PFOS									
45	Rat (Sprague-Dawley) 8–10 M	91 days (W)	0, 0.27, 0.79, 2.37	BC	Endocr Develop		0.27 M 3.2 F		42% decrease in total T4 levels 19–36% reduced serum T4 levels in pups on PNDs 21–35 after gestation- and/or postnatal-only exposure
Yu et al. 2009a									
PFOS potassium salt									

2. HEALTH EFFECTS

Table 2-4. Levels of Significant Exposure to PFOS – Oral

Figure key ^a	Species (strain) No./group	Exposure parameters	Doses (mg/kg/day)	Parameters monitored	Endpoint	NOAEL (mg/kg/day)	Less serious LOAEL (mg/kg/day)	Serious LOAEL (mg/kg/day)	Effect
46	Mouse (E3L CETP) 6–8 M	4–6 weeks (F)	0, 3	BW, FI, BC, OW	Bd wt Hepatic	3 3			Decreased plasma triglyceride, total cholesterol, non-HDL cholesterol, and HDL cholesterol levels; increased hepatic triglyceride levels, increased liver weight
Bijland et al. 2011									
PFOS									
47	Mouse (C57BL/6N) 10 M	60 days (G)	0, 0.00833, 0.08333, 0.41667, 0.83333, 2.0833	FX	Immuno	0.0083	0.0833		Impaired response to sRBC
Dong et al. 2009									
PFOS potassium salt									
48	Mouse (C57BL/6N) 12 M	60 days (G)	0, 0.00833, 0.0167, 0.0833, 0.4167, 0.8333	FX	Immuno	0.0167	0.0833		Impaired response to sRBC
Dong et al. 2011									
PFOS potassium salt									
49	Mouse (ICR) 6–8 F	GDs 1–17 1 time/day (GW)	0, 20		Bd Wt Develop		20 20		35% reduced maternal body weight 89% increased cleft palate, 25% reduced body weight in fetuses
Era et al. 2009									
PFOS potassium salt									
50	Mouse (CD-1) 10 M	4 weeks (GW)	0, 3, 6	CS, BW, BH, MX, DX	Develop		3		Impaired retention of the task in the water maze test
Fuentes et al. 2007c									

2. HEALTH EFFECTS

Table 2-4. Levels of Significant Exposure to PFOS – Oral

Figure key ^a	Species (strain) No./group	Exposure parameters	Doses (mg/kg/day)	Parameters monitored	Endpoint	NOAEL (mg/kg/day)	Less serious LOAEL (mg/kg/day)	Serious LOAEL (mg/kg/day)	Effect
51	Mouse (B6C3F1) 30 F	21 days (G)	0, 0.005, 0.025		Immuno	0.005	0.025		Decreased host resistance to influenza virus
Guruge et al. 2009									
PFOS									
52	Mouse (B6C3F1) 10–12 F	GDs 1–17 1 time/day (GW)	0, 0.1, 1, 5	MX, DX, BW, CS, OF	Develop	0.1	1		42.5% reduced NK cell activity in male pups at 8 weeks of age
Keil et al. 2008									
PFOS potassium salt									
53	Mouse (CD-1) 21–22 F	GDs 1–17 1 time/day (GW)	0, 1, 5, 10, 15, 20	DX, OW, BI	Develop		1	10	1 mg/kg/day: delayed eye opening at ≥1 mg/kg/day, ~ 0% postnatal survival at weaning versus 90% in controls at 10 mg/kg/day
Lau et al. 2003									
PFOS potassium salt									
54	Mouse (CD-1) 4 dams; 8 fetuses	GDs 1–17 (GO)	3	BC, EA, OF	Hepatic Develop	3		3	No alteration in maternal hepatic lipid levels Significant increase in cholesterol levels in fetal livers
Lee et al. 2015b									
PFOS									
55	Mouse (C57BL/6) 15 M,F	Daily 3 months (G)	0, 0.43, 2.15, 10.75	FX	Neuro	0.43	2.15		Impaired spatial learning and memory
Long et al. 2013									
PFOS									

2. HEALTH EFFECTS

Table 2-4. Levels of Significant Exposure to PFOS – Oral

Figure key ^a	Species (strain) No./group	Exposure parameters	Doses (mg/kg/day)	Parameters monitored	Endpoint	NOAEL (mg/kg/day)	Less serious LOAEL (mg/kg/day)	Serious LOAEL (mg/kg/day)	Effect
56	Mouse (BALB/c) 28 M	3 weeks	0, 2.5, 5 and 10	BW, OF, OW	Bd Wt Immuno	2.5 M	10 M 5 M		~15% reduction in body weight during the recovery period ~36% decrease in spleen index during recovery; ~15% inhibition in Con A-induced T-cell proliferation during treatment; 32% increase in CD3+ cells after recovery; ~60% increase in CD3+CD8+ cells and ~56% increase in CD3+CD4+ cells on week 2; 15% inhibition in Con A-induced T-cell proliferation during recovery
Lv et al. 2015									
PFOS									
57	Mouse (C57BL/6J-Apc+/+) 20–21 F	GDs 1–7 (GW)	0, 0.01, 0.1, 3.0	BC, BW, FI, HE, OW	Develop	0.1	3		Decrease in number of successful births
Ngo et al. 2014									
PFOS									
58	Mouse (C57BL/6/Bk1) 6 F	GDs 1–21 ad lib	0, 0.3		Develop		0.3		Decreased locomotion, muscle strength and motor coordination in adult offspring
Onishchenko et al. 2011									
PFOS, potassium salt									
59	Mouse (B6C3F1) 5M, 5F	28 days (G)	0, 0.000166, 0.00166, 0.00331, 0.0166, 0.0331, 0.166	OW, FX	Immuno	0.000166 M	0.00166 M		Suppressed response to sRBC (~60%)
Peden-Adams et al. 2008									
PFOS potassium salt									

2. HEALTH EFFECTS

Table 2-4. Levels of Significant Exposure to PFOS – Oral

Figure key ^a	Species (strain) No./group	Exposure parameters	Doses (mg/kg/day)	Parameters monitored	Endpoint	NOAEL (mg/kg/day)	Less serious LOAEL (mg/kg/day)	Serious LOAEL (mg/kg/day)	Effect
60	Mouse (B6C3F1) 5 M	28 days (F)	0.20	NS	Bd Wt Immuno	0.2	0.2		21% reduction in body weight No alterations in thymic lymphocyte phenotypes, response to sRBC, or IgM antibodies to LPS
Qazi et al. 2010b									
PFOS									
61	Mouse (CD-1) 5 F	GDs 1–17 1 time/day (GW)	0, 5, 10		Develop	5			Peroxisome proliferation in fetal liver at ≥5 mg/kg/day
Rosen et al. 2009									
PFOS, potassium salt									
62	Mouse (CD-1) 60–80 F	GDs 1–17 (GW)	0, 1, 5, 10, 15, 20	BW, OW, BI, DX	Bd Wt Hepatic Endocr Develop	20 20 15 1	20 5	20	Increase in absolute and relative liver weight and decreased serum triglycerides at ≥5 mg/kg/day Decreased total T4 on GD 6 Increased incidences of sternal defects at ≥5 mg/kg/day; reduced percentage of live fetuses (9%) at 20 mg/kg/day
Thibodeaux et al. 2003									
PFOS potassium salt									
63	Mouse (CD-1) 4 M	21 days 1 time/day (GO)	0, 1, 5, 10	BW, BI, OW, HP	Bd Wt Hepatic Repro	5 10 5	10 10		~15% reduced body weight Increased absolute liver weight at ≥5 mg/kg/day ~17% reduced serum testosterone, ~38% reduced epididymal sperm count
Wan et al. 2011									
PFOS potassium salt									

2. HEALTH EFFECTS

Table 2-4. Levels of Significant Exposure to PFOS – Oral

Figure key ^a	Species (strain) No./group	Exposure parameters	Doses (mg/kg/day)	Parameters monitored	Endpoint	NOAEL (mg/kg/day)	Less serious LOAEL (mg/kg/day)	Serious LOAEL (mg/kg/day)	Effect
64	Mouse (CD-1) 6 F (dams)	GD 3 to PND 21 or GD 3 to PND 63 (GO)	0, 0.3, 3	BW, OF, OW	Hepatic	3			~24% increase in relative liver weight in dams at 3 mg/kg/day
					Develop	3			Increase in relative liver weight at 3 mg/kg/day in male and female pups on PND 21 (~20–32%), in male STD-fed adults (~11%), and in male HDF-fed adults (~33%)
					Develop		0.3		In PND 63 offspring fed a high fat diet, increased serum glucose levels at ≥0.3 mg/kg/day in females (~40%) and 3 mg/kg/day in males (~8%); increased serum insulin in males (~109%) and females (~85%) increased response to oral glucose tolerance test, increased HOMA-IR index, and 33% increased relative liver weight at 3 mg/kg/day
					Other noncancer	3 F			No significant alteration in fasting serum insulin or glucose levels; significant increase in HOMA-IR index at 0.3 and 3 mg/kg/day
Wan et al. 2014b									
PFOS									
65	Mouse (C57BL/6) 10 M	30 days (GO)	0, 2.5, 5, 10	BW, HP, OF, OW	Bd Wt		10		31% reduction in body weight (correlated with 68% reduction in feed consumption)
					Hepatic		2.5		Increased liver weight (35%) and serum AST(~12%) and GGT levels (~98%) at ≥2.5 mg/kg/day; increases in ALT (~45%) and ALP (~36%) at ≥5 mg/kg/day; cytoplasmic vacuolation, focal or flake-like necrosis, and hepatocellular hypertrophy observed, but no incidence data provided
					Renal	10			
Xing et al. 2016									
PFOS									

2. HEALTH EFFECTS

Table 2-4. Levels of Significant Exposure to PFOS – Oral

Figure key ^a	Species (strain) No./group	Exposure parameters	Doses (mg/kg/day)	Parameters monitored	Endpoint	NOAEL (mg/kg/day)	Less serious LOAEL (mg/kg/day)	Serious LOAEL (mg/kg/day)	Effect
66	Mouse (ICR) 5 F	GDs 0–17 GDs 0–18 (GW)	0, 1, 10, 20		Hepatic	20			60% increased absolute liver weight at ≥10 mg/kg/day
					Develop		1	20	GDs 0–17: 15.8% increased sternal defects in fetuses at ≥1 mg/kg/day; 8.8% decrease in number of live fetuses at 20 mg/kg/day
					Develop			10	GDs 0–18: decreased survival (55.2%) at 10 mg/kg/day on PND 4, decreased neonatal BW, intracranial blood vessel dilatation, lung atelectasis
Yahia et al. 2008									
PFOS potassium salt									
CHRONIC EXPOSURE									
67	Rat (Sprague-Dawley) 70 M,F	104 weeks ad lib (F)	0, 0.025, 0.10, 0.25, 1.04	CS, BW, FC, GN, HP, BI	Bd Wt	0.25 F	1.04 F		14% reduction in final body weight
					Resp	1.04			
					Cardio	1.04			
					Gastro	1.04			
					Hemato	1.04			
					Musc/skel	1.04			
					Hepatic	0.25 M	1.04 M		Hepatocellular hypertrophy at ≥0.1 mg/kg/day; single cell necrosis and cystic degeneration at 1.04 mg/kg/day
					Renal	1.04			
					Dermal	1.04			
					Ocular	1.04			
					Endocr	1.04			
					Immuno	1.04			No histological alterations

2. HEALTH EFFECTS

Table 2-4. Levels of Significant Exposure to PFOS – Oral

Figure key ^a	Species (strain) No./group	Exposure parameters	Doses (mg/kg/day)	Parameters monitored	Endpoint	NOAEL (mg/kg/day)	Less serious	Serious	Effect
							LOAEL (mg/kg/day)	LOAEL (mg/kg/day)	
					Neuro	1.04			No histological alterations
					Repro	1.04			No histological alterations

Butenhoff et al. 2012b; Thomford 2002b
PFOS potassium salt

^aThe number corresponds to entries in Figure 2-7.

^bUsed to derive an intermediate-duration oral MRL of 2×10^{-6} mg/kg/day based on the predicted TWA serum PFOA level of 29.7 µg/mL at the NOAEL dose and an empirical clearance model to estimate a HED. The NOAEL_{HED} of 0.000515 mg/kg/day was divided by an uncertainty factor of 30 (3 for extrapolation from animals to humans with dosimetric adjustment and 10 for human variability) and a modifying factor of 10 for concern that immunotoxicity may be a more sensitive endpoint than developmental toxicity.

ALP = alkaline phosphatase; ALT = alanine aminotransferase; AST = aspartate aminotransferase; BC = biochemistry; BH = behavioral; BI = biochemical changes; BW or Bd wt = body weight; C = capsule; Cardio = cardiovascular; CS = clinical signs; Develop = developmental; DX = developmental toxicity; EA = enzyme activity; Endocr = endocrine; (F) = feed; F = female(s); FX = fetal toxicity; FI = food intake; FO = fetal toxicity; G = gavage; Gastro = gastrointestinal; GD = gestation day; GGT = gamma-glutamyl transferase; GN = gross necropsy; GO = gavage in oil vehicle; GW = gavage in water vehicle; HDL = high-density lipoprotein; HE or Hemato = hematology; HED = human equivalent dose; HOMA IR = Homeostatic Model Assessment of Insulin Resistance; HP = histopathology; Immuno = immunotoxicological; LD = lactation day; LD50 = lethal dose, 50% kill; LE = lethality; LOAEL = lowest-observed-adverse-effect level; LPS = lipopolysaccharide; M = male(s); MRL = Minimal Risk Level; Musc/skel = musculoskeletal; MX = maternal toxicity; Neuro = neurological; NK = natural killer; NOAEL = no observed-adverse-effect level; NS = not specified; OF = organ function; OP = ophthalmology; OW = organ weight; PFOS = perfluorooctane sulfonic acid; PND = postnatal day; Repro = reproductive; Resp = respiratory; sRBC = sheep red blood cell; T3 = triiodothyronine; T4 = thyroxine; TSH = thyroid-stimulating hormone; TT4 = total thyroxine; TWA = time-weighted average; W = water

2. HEALTH EFFECTS

Figure 2-7. Levels of Significant Exposure to PFOS – Oral Acute (≤14 days)

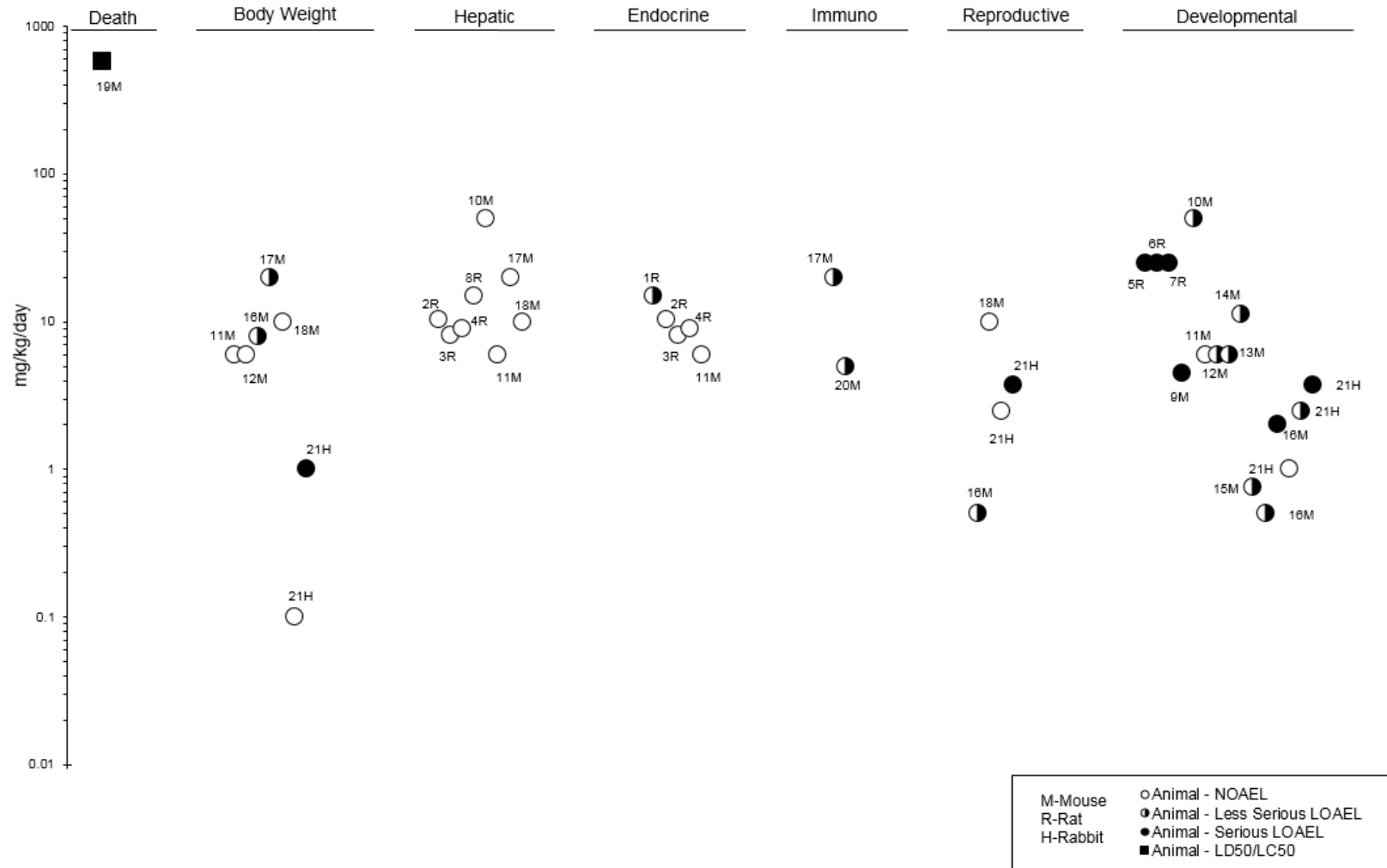

2. HEALTH EFFECTS

Figure 2-7. Levels of Significant Exposure to PFOS – Oral Intermediate (15–364 days)

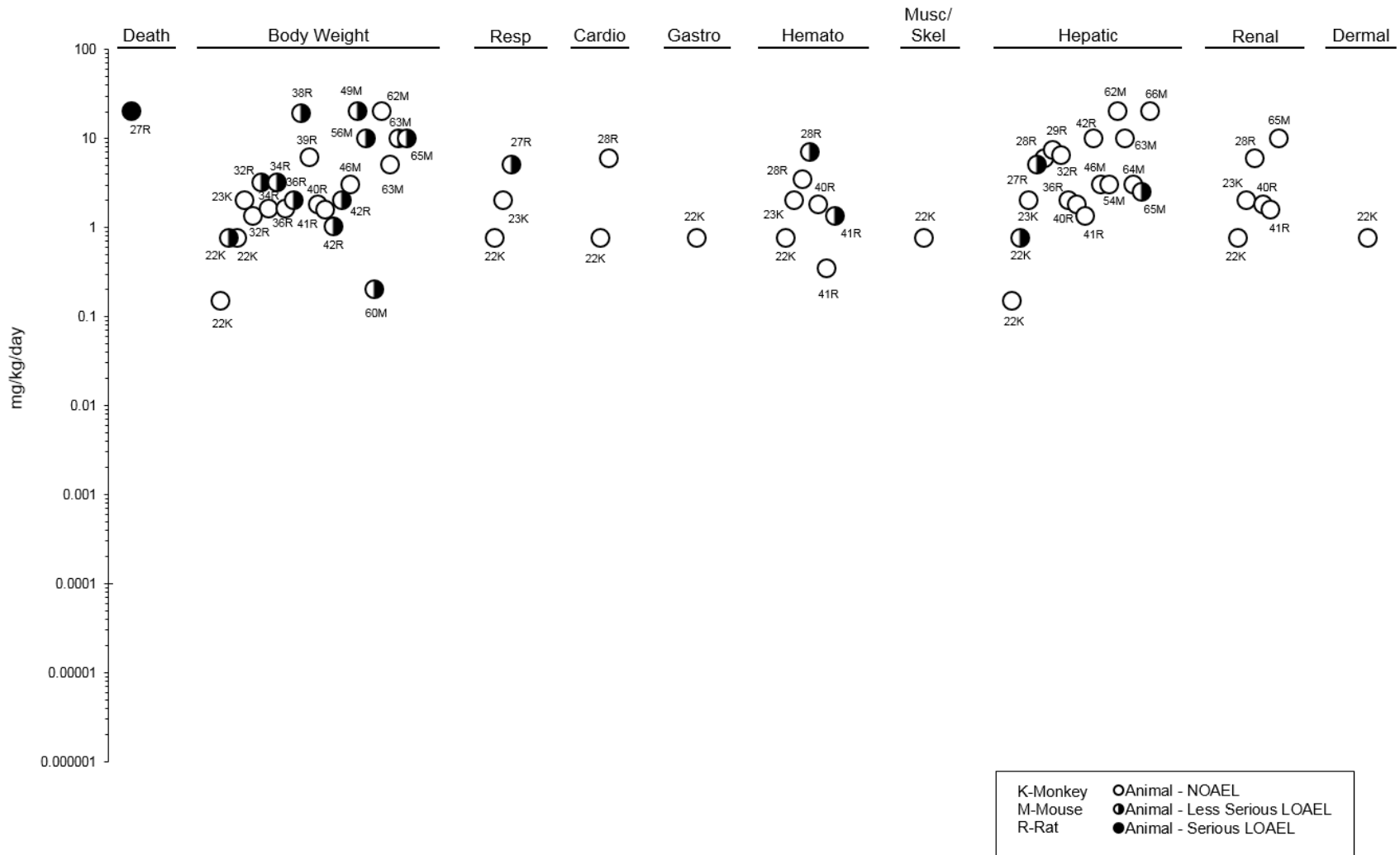

2. HEALTH EFFECTS

Figure 2-7. Levels of Significant Exposure to PFOS – Oral Intermediate (15–364 days)

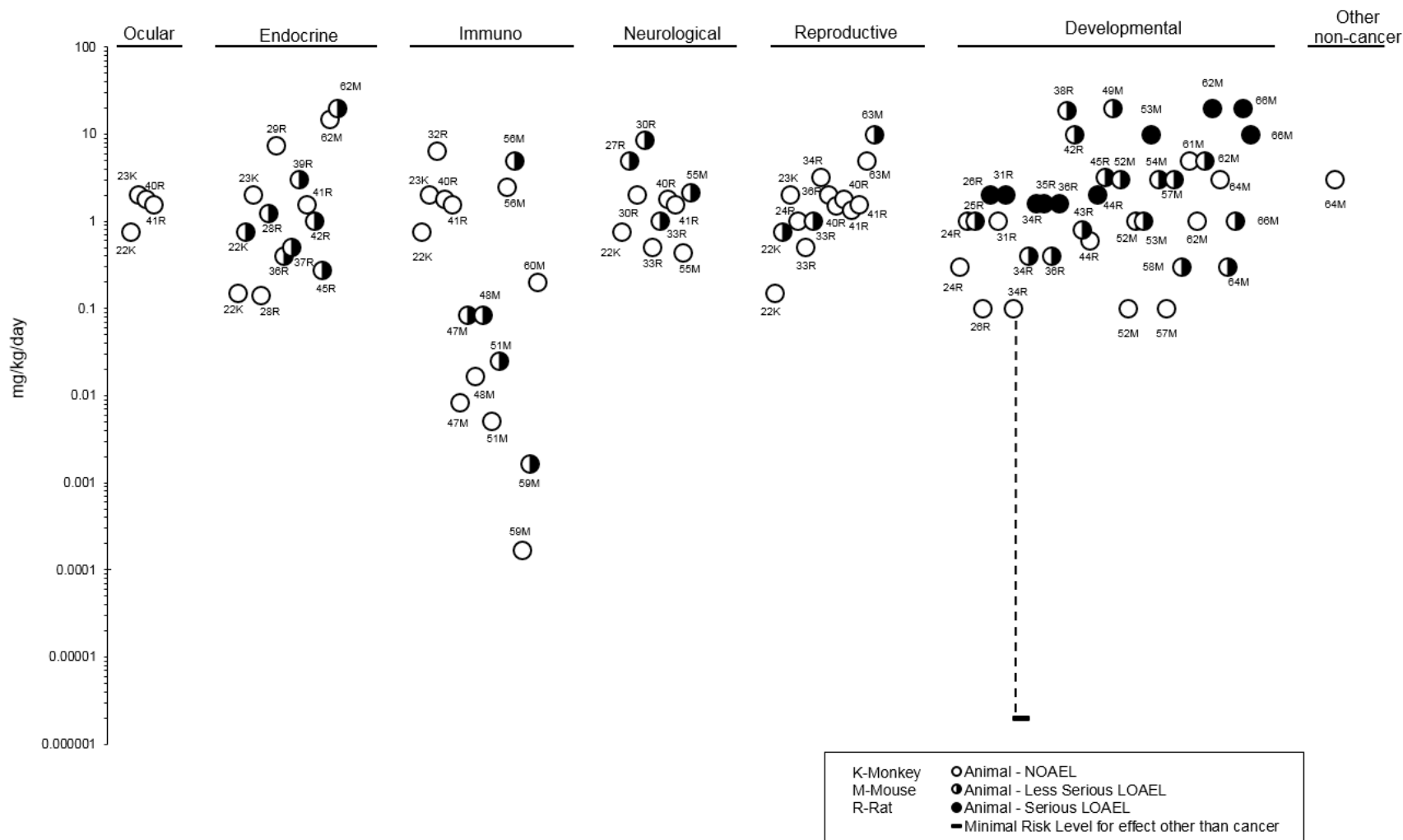

2. HEALTH EFFECTS

Figure 2-7. Levels of Significant Exposure to PFOS – Oral
 Chronic (≥365 days)

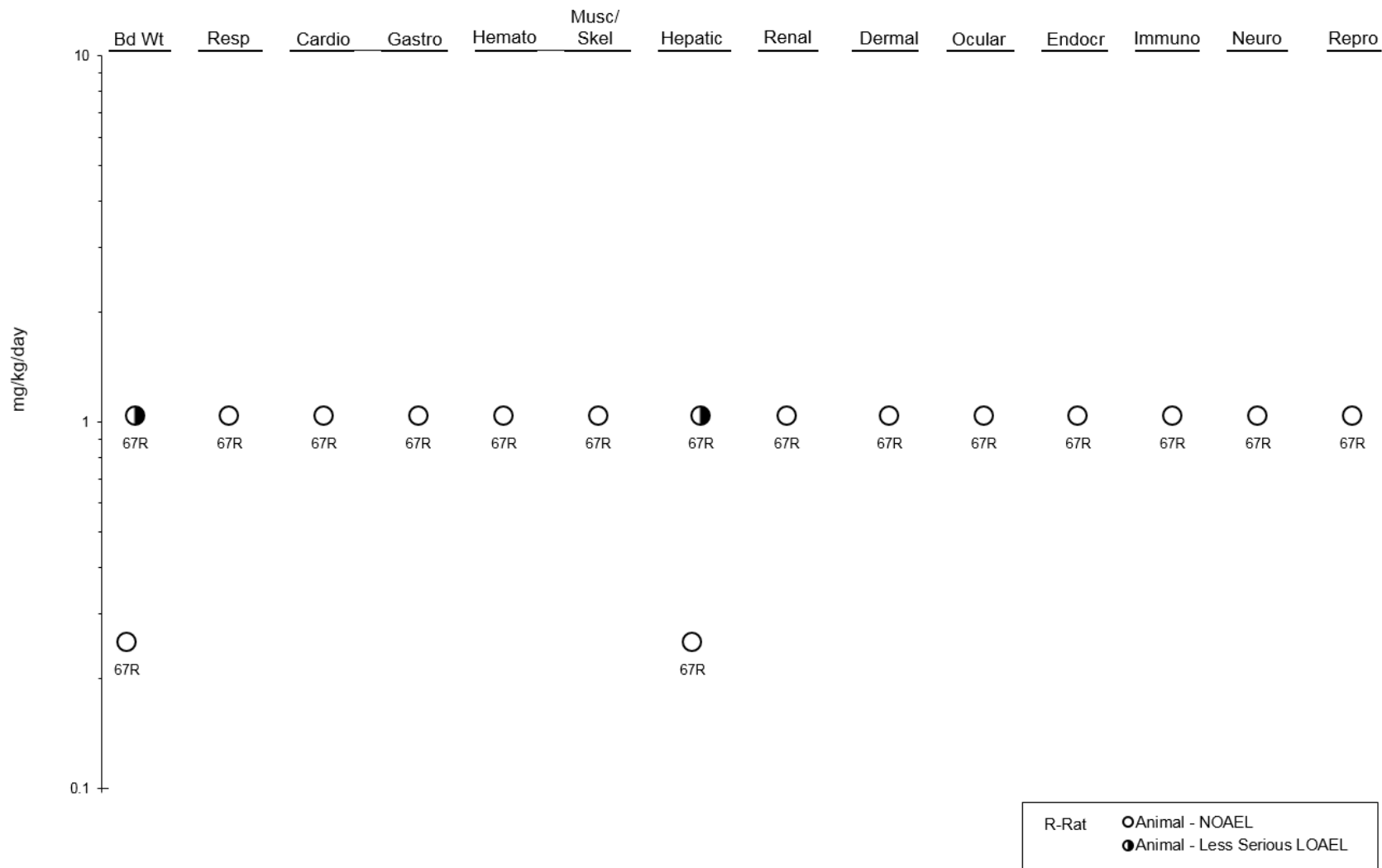

2. HEALTH EFFECTS

Table 2-5. Levels of Significant Exposure to Other Perfluoroalkyls – Oral

Figure key ^a	Species (strain) No./group	Exposure parameters	Doses (mg/kg/day)	Parameters monitored	Endpoint	NOAEL (mg/kg/day)	Less serious LOAEL (mg/kg/day)	Serious LOAEL (mg/kg/day)	Effect
ACUTE EXPOSURE									
PFHxS									
1	Mouse (SV129 WT and PPAR α null) 4 M	7 days (G)	0, 10 PFHxS	BW, HP	Bd Wt Hepatic	10 10			Hepatocellular hypertrophy, steatosis, and increased hepatic triglyceride levels
Das et al. 2017									
2	Mouse (NMRI) 14–18 M,F	PND 10 Once (GO)	0, 0.61, 6.1, 9.2 PFHxS		Develop	6.1	9.2		Altered spontaneous behavior and habituation in adults exposed as neonates
Viberg et al. 2013									
PFNA									
3	Rat (Sprague-Dawley) 10 M	14 days (GW)	0, 1, 3, 5 PFNA	BC, BW, OW	Bd wt Immuno	1	3 1		Decreases in body weight at 3 and 5 mg/kg/day (18 and 39%) 24% increase in relative thymus weight at 1 mg/kg/day; 20% decrease in thymus weight at 3 or 5 mg/kg/day, increases in thymic cortex:medulla ratios, alterations in cytokine levels at ≥ 3 mg/kg/day
Fang et al. 2009									
4	Rat (Sprague-Dawley) 10 M	14 days (GW)	0, 1, 3, 5 PFNA	BC, OW	Immuno	3	5		Decreased relative spleen weight and increases in cytokine levels
Fang et al. 2010									
5	Rat (Sprague-Dawley) 6 M	14 days (GW)	0, 0.2, 1, 5 PFNA	BC	Hepatic Other noncancer (glucose)	5 0.2	1		Decreased HDL levels at ≥ 1 mg/kg/day Increased serum glucose levels (1.11-fold at 1 mg/kg/day and 1.16-fold at 5 mg/kg/day)
Fang et al. 2012a									
6	Rat (Sprague-Dawley) 6 M	14 days (GW)	0, 0.2, 1, 5 PFNA	HP	Hepatic	5			Hepatocellular vacuolation and lipid accumulation at 5 mg/kg/day
Fang et al. 2012b									

2. HEALTH EFFECTS

Table 2-5. Levels of Significant Exposure to Other Perfluoroalkyls – Oral

Figure key ^a	Species (strain) No./group	Exposure parameters	Doses (mg/kg/day)	Parameters monitored	Endpoint	NOAEL (mg/kg/day)	Less serious LOAEL (mg/kg/day)	Serious LOAEL (mg/kg/day)	Effect
7	Rat (Sprague-Dawley) 6 M	14 days (GW)	0, 1, 3, 5 PFNA	BC, HP	Repro	3	5		85.4% decrease in serum testosterone and 105% increase in estradiol levels at 5 mg/kg/day; atrophy of seminiferous tubule epithelium
Feng et al. 2009									
8	Rat (Sprague-Dawley) 6 M	14 days (GW)	0, 1, 3, 5 PFNA	HP	Repro	3	5		Large vacuoles between testicular Sertoli cells and spermatogonia
Feng et al. 2010									
9	Rat (Wistar)	14 days (GO) 8 or 10M	0, 0.0125, 0.25, 5 PFNA	BI, BW, OW, GN, HP	Bd Wt Endocr		5 5		Decreased body weight; magnitude of effect was not reported Decreased androstenedione and testosterone concentrations (data not shown)
Hadrup et al. 2016									
10	Mouse (SV129 WT and PPAR α null) 4 M	7 days (G)	0, 10 PFNA	BW, HP	Bd Wt Hepatic	10 10			Hepatocellular hypertrophy, steatosis, and increased hepatic triglyceride levels
Das et al. 2017									
11	Mouse (BALB/c) 6 M	14 days (G)	0, 1, 3, 5 PFNA	FX	Immuno		1		Decreases in the percentages of F4/80+ and CD49b+ cells in the spleen; no alteration in the response of splenic lymphocytes to ConA at \leq 5 mg/kg/day
Fang et al. 2008									
12	Mouse (CD-1) 5 M,F	14 days (F)	0, 0.5, 1.8, 5.3, 54, 537 PFNA	LE, OW	Death Hepatic			54 5.3	100% mortality before day 14 50–70% increase in absolute liver weight at \geq 0.5 mg/kg/day
Kennedy 1987									

2. HEALTH EFFECTS

Table 2-5. Levels of Significant Exposure to Other Perfluoroalkyls – Oral

Figure key ^a	Species (strain) No./group	Exposure parameters	Doses (mg/kg/day)	Parameters monitored	Endpoint	NOAEL (mg/kg/day)	Less serious LOAEL (mg/kg/day)	Serious LOAEL (mg/kg/day)	Effect
13	Mouse (BALB/c) 8 M	14 days (G)	0, 0.2, 1, 5 PFNA	BW, OW, BC	Bd Wt	1	5		~25% decrease in body weight
					Hepatic	1	5		Increases in liver weight (~160%) and increases in hepatic triglyceride (~66%) and cholesterol levels (~26%) at ≥0.2 mg/kg/day; decreases in serum triglyceride (~67%) and cholesterol levels (~32%) and increases in serum ALT (~900%) and AST (~280%) levels at 5 mg/kg/day
Wang et al. 2015a									
PFDeA									
14	Rat (Wistar) 5–12 M	Once (GO)	0, 50 PFDeA	BW, FX	BW			50	8% weight loss was observed 10-days post-exposure
					Neuro	50			No alteration in performance on novel object recognition test
Kawabata et al. 2017									
15	Rat (Wistar) 25 M	1 week (F)	0, 1.2, 2.4, 4.7, 9.5 PFDeA	BE, OW, EA	Bd Wt	4.7		9.5	~32% weight loss
					Hepatic	9.5			Increases in liver weight at ≥2.4 mg/kg/day; increases in hepatic cholesterol at 9.5 mg/kg/day
Kawashima et al. 1995									
16	Mouse (C57BL/6N) 4 F	Once (GO)	0, 40, 80, 100, 120, 160 PFDeA	OW, EA	Hepatic	160			Increase in hepatic lipids and liver weight 2 days post-exposure at 40 mg/kg/day
Brewster and Birnbaum 1989									
17	Mouse (C57BL/6N) 12–14 F	GDs 6–15 (GO)	0, 0.03, 0.1, 0.3, 1, 3, 6.4, 12.8 PFDeA	MX, DX, BW, OW	Bd Wt	3	6.4	12.8	No weight gain at 6.4 mg/kg/day and weight loss at 12.8 mg/kg/day (net change of -2.4)
					Develop	0.3	1	12.8	18–22% decreases in fetal weight per litter at ≥1 mg/kg/day; decreases in live fetuses per litter at 12.8 mg/kg/day (4.6 versus 7.2 in controls)
Harris and Birnbaum 1989									

2. HEALTH EFFECTS

Table 2-5. Levels of Significant Exposure to Other Perfluoroalkyls – Oral

Figure key ^a	Species (strain) No./group	Exposure parameters	Doses (mg/kg/day)	Parameters monitored	Endpoint	NOAEL (mg/kg/day)	Less serious LOAEL (mg/kg/day)	Serious LOAEL (mg/kg/day)	Effect
18	Mouse (C57BL/6N) 10 F	Once (GO)	0, 20, 40, 80, 160, 320 PFDeA	BW, OW, GN, HP	Death Bd Wt Cardio Hepatic Renal Endocr Immuno	40 80 80 80 40 40	80 80	120 160	LD ₅₀ in 30-day observation period 12% decreased body weight 30 days post-exposure No histological alterations in the heart 30 days post-exposure; decreased relative heart weight at 80 mg/kg/day Increases in liver weight and pancellular hypertrophy at ≥20 mg/kg/day 30 days post-exposure No histological alterations 30 days post-exposure 2-fold increase in T3 and 4-fold increase in T4 levels 30 days post-exposure 28% decrease in relative spleen weight at 80 mg/kg/day; atrophy and lymphoid depletion in thymus and spleen at 160 mg/kg/day
Harris et al. 1989									
19	Mouse (CD-1) 10 M	Once on PND 10 (G)	0, 0.72, 10.8 PFDeA	CS, DX	Develop	10.8			No alteration in spontaneous activity or habituation at 2–4 months of age
Johansson et al. 2008									
20	Mouse (C57BL/6N) 4 M	10 days (F)	0, 78 PFDeA	BW, OW, EA	Bd Wt Hepatic	78 78		78	33% weight loss 36% increase in liver weight
Permadi et al. 1992, 1993									
PFBA									
21	Rat (Sprague-Dawley) 3 M,F	5 days 1 time/day (GW)	0, 18, 58, 184 PFBA	CS, BW, OW, HE, BI, GN, HP	Bd Wt Resp Cardio Gastro Hemato Musc/skel Hepatic Renal	184 184 184 184 184 184 184 184			

2. HEALTH EFFECTS

Table 2-5. Levels of Significant Exposure to Other Perfluoroalkyls – Oral

Figure key ^a	Species (strain) No./group	Exposure parameters	Doses (mg/kg/day)	Parameters monitored	Endpoint	NOAEL (mg/kg/day)	Less serious LOAEL (mg/kg/day)	Serious LOAEL (mg/kg/day)	Effect
					Endocr	184			
					Immuno	184			No histological alterations
					Neuro	184			No histological alterations
					Repro	184			No histological alterations
3M 2007a									
22	Rat (Sprague-Dawley) 3 M	14 days ad lib (F)	0, 20 PFBA	OW, EA	Hepatic	20			Biochemical and ultrastructural evidence of peroxisome proliferation
Ikeda et al. 1985									
23	Mouse (C57BL/6N) 4 M	10 days (F)	0, 78 PFBA	BW, OW, EA	Bd Wt Hepatic	78 78			63% increase in absolute liver weight
Permadi et al. 1992, 1993									
PFD_oA									
24	Rat (Wistar) 5–12 M	Once (GO)	0, 5, 20, 50 PFD _o A	BW, FX	BW Neuro		50 50		44% decrease in body weight gain (measured 10-days post-exposure) Impaired performance on novel object recognition test
Kawabata et al. 2017									
25	Rat (Wistar) 10 M	Once (GO)	0, 50 PFD _o A	FX	Neuro	50			No alterations in open field activity
Kawabata et al. 2017									
26	Rat (Wistar) 8 M	Once (GO)	0, 50 PFD _o A	FX	Neuro	50			No alterations in tests of working memory or depressive behavior.
Kawabata et al. 2017									

2. HEALTH EFFECTS

Table 2-5. Levels of Significant Exposure to Other Perfluoroalkyls – Oral

Figure key ^a	Species (strain) No./group	Exposure parameters	Doses (mg/kg/day)	Parameters monitored	Endpoint	NOAEL (mg/kg/day)	Less serious LOAEL (mg/kg/day)	Serious LOAEL (mg/kg/day)	Effect
27	Rat (Sprague-Dawley) 10 M	14 days 1 time/day (GW)	0, 1, 5, 10 PFDoA	BW, OW, BI	Bd Wt	1	5		25% reduction in final body weight
					Hepatic	10		35% increase in total serum cholesterol at 10 mg/kg/day	
					Repro	1	5	Decreased serum testosterone (38%) and estradiol (~38%), and ultrastructural alterations in testes at ≥5 mg/kg/day; decreased testicular weight at 10 mg/kg/day (22%)	
Shi et al. 2007									
28	Rat (Sprague-Dawley) 10 M	14 days 1 time/day (GW)	0, 1, 5, 10 PFDoA	OW, BI, HP	Hepatic	10			Increased liver weight, increase in increased hepatic triglyceride and cholesterol levels at ≥5 mg/kg/day; increased serum triglyceride levels at 10 mg/kg/day
Zhang et al. 2008									
PFOSA									
29	Rat (Sprague-Dawley) 15 M	Once (GO)	0, 5 PFOSA	BW, OW	Bd Wt Hepatic	5 5			No alterations in liver weight
Seacat and Luebker 2000									
PFHxA									
30	Mouse (CD1) 20 F	GDs 6–18 (GW)	0, 100, 350, 500 PFHxA	CS, DX	Develop	100	350		12.5% decrease in birth weight and delayed eye opening at ≥350 mg/kg/day; increased pup mortality (PND 0–3) and decreased pup survival at 500 mg/kg/day
Iwai and Hoberman 2014									
31	Mouse (CD1) 20 F	GDs 6–18 (GW)	0, 7, 35, 175 PFHxA	CS, DX	Develop	35	175		Increase in stillborn pups and 12.5% decrease in birth weight
Iwai and Hoberman 2014									

2. HEALTH EFFECTS

Table 2-5. Levels of Significant Exposure to Other Perfluoroalkyls – Oral

Figure key ^a	Species (strain) No./group	Exposure parameters	Doses (mg/kg/day)	Parameters monitored	Endpoint	NOAEL (mg/kg/day)	Less serious LOAEL (mg/kg/day)	Serious LOAEL (mg/kg/day)	Effect
INTERMEDIATE EXPOSURE									
PFHxS									
32	Rat (Sprague-Dawley) 15 M,F	42–56 days 1 time/day (GW)	0, 0.3, 1, 3, 10 PFHxS	CS, BW, MX, DX, OW, OF, BI, HE, GN, HP, FI	Bd Wt Resp Cardio Gastro Hemato Hepatic Renal Endocr Immuno Neuro Repro Develop	10 10 10 10 10 F 10 3 M 1 ^b M 10 F 10 10 10 10 F	 0.3 M 10 M 3 M		 6% increase in prothrombin time in males at ≥0.3 mg/kg/day; decreases in hemoglobin (4%), hematocrit (3%), and RBC levels (2.4%) in males at ≥3 mg/kg/day Increased liver weight; centrilobular hepatocellular hypertrophy in males at ≥3 mg/kg/day 31% increase in BUN in males Hypertrophy and hyperplasia of thyroid follicular cells in males No histological alterations No histological alterations No histological alterations or effects on fertility
Butenhoff et al. 2009a; Hoberman and York 2003									
33	Mouse (E3L CETP) 6–8 M	4–6 weeks (F)	0, 6 PFHxS	BW, FI, BC, OW	Bd wt Hepatic	6 6			Decreased plasma triglyceride, cholesterol, non-HDL cholesterol, and HDL cholesterol levels; increased hepatic triglyceride levels, increased liver weight
Bijland et al. 2011									

2. HEALTH EFFECTS

Table 2-5. Levels of Significant Exposure to Other Perfluoroalkyls – Oral

Figure key ^a	Species (strain) No./group	Exposure parameters	Doses (mg/kg/day)	Parameters monitored	Endpoint	NOAEL (mg/kg/day)	Less serious LOAEL (mg/kg/day)	Serious LOAEL (mg/kg/day)	Effect
PFNA									
34	Rat (Sprague-Dawley) 18 dams; 10–12 M,F pups/litter	GDs 1–20 (GW)	5 PFNA	BW, OF, OW	Bd Wt Develop		5 5		Reduced maternal body weight; approximately 33% on GD 7 and 10% on GD 20 Decreased birth weight in female pups only (approximately 11%); increased systolic blood pressure in 10-week-old male and female offspring; reduced nephron endowment
Rogers et al. 2014									
35	Mouse (CD-1) 8–10F	GDs 1–17 (GW)	1, 3, 5, 10 PFNA	BC, DX, FX, MX, OW	Bd Wt Hepatic Develop			10 3 5	43% maternal weight loss at GD 13 Increases in absolute and relative liver weights in dams on GD 17 and on post-weaning day 28 at ≥1 mg/kg/day Delayed postnatal development [eye opening, preputial separation and vaginal opening] and decreased body weight gain persisting in males up to PND 287 at ≥3 mg/kg/day; decreased postnatal survival between PND 2 and 10 with 80% mortality at ≥5 mg/kg/day; full litter resorptions at 10 mg/kg/day
Das et al. 2015									
36	Mouse (129S1/SvIm) 8 F	GDs 1–18 (G)	0, 0.83, 1.1, 1.5, 2.0 PFNA	BW, OW, DX	Bd Wt Hepatic Develop	2.0 2.0 0.83 ^c			No alterations in maternal body weight or gestational weight gain Increase in dam liver weight at ≥0.83 mg/kg/day Decreased number of live births (36 and 31%) and pup survival at 1.1 and 2.0 mg/kg/day, but not 1.5 mg/kg/day; decreased number of live pups per litter and decreased pup body weight gain in females at 2 mg/kg/day; increased pup liver weight at ≥0.83 mg/kg/day
Wolf et al. 2010									

2. HEALTH EFFECTS

Table 2-5. Levels of Significant Exposure to Other Perfluoroalkyls – Oral

Figure key ^a	Species (strain) No./group	Exposure parameters	Doses (mg/kg/day)	Parameters monitored	Endpoint	NOAEL (mg/kg/day)	Less serious LOAEL (mg/kg/day)	Serious LOAEL (mg/kg/day)	Effect
37	Mouse (PPAR α knockout) 8 F	GDs 1–18 (G)	0, 0.83, 1.1, 1.5, 2.0 PFNA	BW, OW, DX	Bd Wt	2.0			No alterations in maternal body weight or gestational weight gain
					Hepatic	2.0			Increases in liver weight at ≥ 1.5 mg/kg/day non-pregnant adults, but not in the dams
					Develop	2.0			No alterations in the number of live pups per litter, birth weight, pup survival, day of eye opening, or pup body weight gain; no increases in pup liver weight were observed
Wolf et al. 2010									
PFUA									
38	Rat (CrI:CD[SD]) (GO) 12 M,F (main); 5 M,F (other)	41–46 days (GO)	0, 0.1, 0.3, 1.0 PFUA	BH, BW, CS, HP, OF, OW, UR	Bd Wt	0.3	1.0		Decreased body weight (~10%) in males during exposure and recovery and in satellite females during dosing (~23% on day 40) and recovery (~10%)
					Hemato	0.3	1.0		Main study males: decreased MCV (5%), MCH (5%), APTT (25%), and fibrinogen (33%) and increased platelet counts (7%); satellite males: increased WBC (52%) and decreased APTT (16%) and fibrinogen (19%); main study females: increased MCV (10%) and MCH (10%) and decreased fibrinogen (32%)
					Hepatic	1.0			Increased absolute and relative liver weight and centrilobular hypertrophy at 1.0 mg/kg/day
					Renal	0.3	1.0		Increased BUN (61%) and ALP (140%); decreased total protein (11%) and albumin (7%) in main group males
				Develop	0.3 F	1.0 F		Decreased body weight in pups on PNDs 0 and 4 (13–19% in males and 12–16% in females)	
Takahashi et al. 2014									

2. HEALTH EFFECTS

Table 2-5. Levels of Significant Exposure to Other Perfluoroalkyls – Oral

Figure key ^a	Species (strain) No./group	Exposure parameters	Doses (mg/kg/day)	Parameters monitored	Endpoint	NOAEL (mg/kg/day)	Less serious LOAEL (mg/kg/day)	Serious LOAEL (mg/kg/day)	Effect
PFBuS									
39	Rat (Sprague-Dawley)	28 days 1 time/day (GO)	0, 100, 300, 900 PFBuS	CS, BW, FI, HE, BI, GN, HP, OF	Bd Wt Resp Cardio Gastro Hemato Musc/Skel Hepatic Renal Ocular Endocr Immuno Neuro Repro	900 900 900 900 900 900 900 900 900 900 900 900 900			Increased absolute and relative liver weight at 900 mg/kg/day No histological alterations No histological alterations No histological alterations
3M 2001									
40	Rat (Sprague-Dawley) 10 NS	90 days (G)	0, 60, 200, 600 PFBuS	LT, BW, OW, GN, HP, BC, CS, BI, BH, HE	Resp Cardio Gastro Hemato Musc/skel Hepatic Renal Endocr Neuro	600 600 200 60 M 600 600 200 600 600	600 200 M		Necrosis of individual squamous cells in forestomach and hyperplasia and hyperkeratosis of limiting ridge Decreased hemoglobin (4.9%) and hematocrit (5.2%) Hyperplasia of medullary and papillary tubules and medullary ducts and focal papillary edema
Lieder et al. 2009a									

2. HEALTH EFFECTS

Table 2-5. Levels of Significant Exposure to Other Perfluoroalkyls – Oral

Figure key ^a	Species (strain) No./group	Exposure parameters	Doses (mg/kg/day)	Parameters monitored	Endpoint	NOAEL (mg/kg/day)	Less serious LOAEL (mg/kg/day)	Serious LOAEL (mg/kg/day)	Effect
41	Rat (Sprague-Dawley)	P0: starting 70 days prior to mating; F1: starting at weaning (G)	0, 30, 100, 300, 1,000 PFBuS	BW, OW, FI, GN, HP, FX, MX, DX, TG	Bd Wt	1,000			Increased liver weight in males at ≥300 mg/kg/day Medullary/papillary tubular and ductal hyperplasia in P0 and F1
					Hepatic	1,000			
					Renal	100	300		
					Repro	1,000			
				Develop	1,000				
Lieder et al. 2009b									
42	Mouse (E3L CETP) 6–8 M	4–6 weeks (F)	0, 30 PFBuS	BW, FI, BC, OW	Bd wt	30			Decreased plasma triglyceride levels
					Hepatic	30			
Bijland et al. 2011									
PFBA									
43	Rat (Sprague-Dawley) 10 M,F	28 days 1 time/day	0, 6, 30, 150 PFBA	CS, BW, OW, FI, BI, HE, GN, HP, OF	Bd Wt	150			Increased absolute and relative liver weight and decreased serum cholesterol in males at ≥30 mg/kg/day; hepatocellular hypertrophy in males at 150 mg/kg/day
					Resp	150			
					Cardio	150			
					Gastro	150			
					Hemato	150			
					Musc/skel	150			
					Hepatic	150			
					Renal	150			
					Dermal	150			
					Ocular	150			
Endocr	6 M	30 M		Hyperplasia/hypertrophy of follicular epithelium of the thyroid					
Immuno	150			No histological alterations					
Neuro	30 M	150 M		Delayed pupillary reflex					
Repro	150			No histological alterations					
Butenhoff et al. 2012a; van Otterdijk 2007a									

2. HEALTH EFFECTS

Table 2-5. Levels of Significant Exposure to Other Perfluoroalkyls – Oral

Figure key ^a	Species (strain) No./group	Exposure parameters	Doses (mg/kg/day)	Parameters monitored	Endpoint	NOAEL (mg/kg/day)	Less serious LOAEL (mg/kg/day)	Serious LOAEL (mg/kg/day)	Effect
44	Rat (Sprague-Dawley) 10 M,F	90 days 1 time/day	0, 1.2, 6, 30 PFBA	CS, BW, FI, OW, BI, HE, GN, HP	Bd Wt	30			
					Resp	30			
					Cardio	30			
					Gastro	30			
					Hemato	6	30 M		Reduced erythrocyte counts (3.8%), hemoglobin (5.7%), and hematocrit (4.5%)
					Musc/skel	30			
					Hepatic	30			Diffuse panlobular hepatocyte hypertrophy at 30 mg/kg/day in males
					Renal	30			
					Dermal	30			
					Ocular	30			
					Endocr	6 M	30 M		Hypertrophy/hyperplasia of follicular epithelium of the thyroid gland
					Immuno	30			No histological alterations
					Neuro	30			No histological alterations
Repro	30			No histological alterations					
Butenhoff et al. 2012a; van Otterdijk 2007b									
45	Mouse (CD-1)	18 days GDs 1–17 1 time/day (GW)	0, 35, 175, 350 PFBA	BW, MX, DX	Hepatic	350			Significant increase in absolute and relative liver weight at ≥175 mg/kg/day
					Develop		35		Eye opening delayed approximately 1 day
Das et al. 2008									
PFD_oA									
46	Rat (Sprague-Dawley) 8 F	28 days PNDs 24–72 1 time/day (GW)	0, 0.5, 1.5, 3 PFD _o A		Develop	1	3		40% reduced serum estradiol and 20% increased serum cholesterol in pubertal females
Shi et al. 2009									

2. HEALTH EFFECTS

Table 2-5. Levels of Significant Exposure to Other Perfluoroalkyls – Oral

Figure key ^a	Species (strain) No./group	Exposure parameters	Doses (mg/kg/day)	Parameters monitored	Endpoint	NOAEL (mg/kg/day)	Less serious LOAEL (mg/kg/day)	Serious LOAEL (mg/kg/day)	Effect
CHRONIC EXPOSURE									
PFHxA									
47	Rat (Sprague-Dawley) 60 or 70 M,F	104 weeks (GW)	M: 0, 2.5, 15, 100 F: 0, 5, 30, 200 PFHxA	BC, BW, CS, GN, HP, LE, OP, OW, UR	Death			200 F	36, 43, 33, and 22% survival rate in females at 0, 5, 30, and 200 mg/kg/day, respectively
					Bd Wt	100 M 200 F			
					Hemato	100 M	200 F		8.1% reduction in mean red blood cell count and 5.2% reduction in hemoglobin at 51 weeks; 23.6 and 53.6% increase in reticulocyte counts at weeks 25 and 51, respectively
					Hepatic	100 M 30F	200 F		Males: 42% decrease in triglycerides, 19% decrease in free fatty acids in males at 100 mg/kg/day; hepatocellular necrosis; 66% increase in triglycerides, 44% decrease in non-HDL cholesterol in females at 200 mg/kg/day

2. HEALTH EFFECTS

Table 2-5. Levels of Significant Exposure to Other Perfluoroalkyls – Oral

Species Figure (strain) key ^a	Exposure No./group	Doses (mg/kg/day)	Parameters monitored	Endpoint	NOAEL (mg/kg/day)	Less serious LOAEL (mg/kg/day)	Serious LOAEL (mg/kg/day)	Effect
				Renal	100 M	200 F		Mild renal tubular degeneration and mild to severe papillary necrosis; increased mean urine volume (109%) and reduced specific gravity (0.96%)
				Neuro	100 M 200 F			

Klaunig et al. 2015

^aThe number corresponds to entries in Figure 2-8.

^bUsed to derive an intermediate-duration oral MRL of 2×10^{-5} mg/kg/day for PFHxS based on a measured serum PFHxS level of 89.12 µg/mL at the NOAEL dose and an empirical clearance model to estimate a HED. The NOAEL_{HED} of 0.0047 mg/kg/day was divided by an uncertainty factor of 30 (3 for extrapolation from animals to humans with dosimetric adjustment and 10 for human variability) and a modifying factor of 10 for database deficiencies.

^cUsed to derive an intermediate-duration oral MRL of 3×10^{-6} mg/kg/day for PFNA based on a measured serum PFNA level of 8.91 µg/mL at the NOAEL dose and an empirical clearance model to estimate a HED. The NOAEL_{HED} of 0.001 mg/kg/day was divided by an uncertainty factor of 30 (3 for extrapolation from animals to humans with dosimetric adjustment and 10 for human variability) and a modifying factor of 10 for database deficiencies.

ALT = alanine aminotransferase; APTT = activated partial thromboplastin time; AST = aspartate aminotransferase; BC = biochemistry; BH = behavioral; BI = biochemical changes; BUN = blood urea nitrogen; BW or Bd wt = body weight; Cardio = cardiovascular; CI = confidence interval; CS = clinical signs; Develop = developmental; DX = developmental toxicity; EA = enzyme activity; Endocr = endocrine; (F) = feed; F = female(s); FI = food intake; FX = fetal toxicity; G = gavage; Gastro = gastrointestinal; GD = gestation day; GN = gross necropsy; GO = gavage in oil vehicle; GW = gavage in water vehicle; HDL = high-density lipoprotein; HE or Hemato = hematology; HP = histopathology; Immuno = immunotoxicological; LD₅₀ = lethal dose, 50% kill; LE = lethality; LOAEL = lowest-observed-adverse-effect level; M = male(s); MCH = mean corpuscular hemoglobin; MCV = mean corpuscular volume; Musc/skel = musculoskeletal; MX = maternal toxicity; Neuro = neurological; NOAEL = no observed-adverse-effect level; NS = not specified; OF = organ function; OP = ophthalmology; OW = organ weight; PFBA = perfluorobutyric acid; PFBuS = perfluorobutane sulfonic acid; PFDeA = perfluorodecanoic acid; PFDoA = perfluorododecanoic acid; PFHxA = perfluorohexanoic acid; PFHxS = perfluorohexane sulfonic acid; PFNA = perfluorononanoic acid; PFOSA = perfluorooctane sulfonamide; PFUA = perfluoroundecanoic acid; PPARα = peroxisome proliferator-activated receptor-α; Repro = reproductive; Resp = respiratory; TG = teratogenicity; UR = urinalysis

2. HEALTH EFFECTS

**Figure 2-8. Levels of Significant Exposure to Other Perfluoroalkyls – Oral
Acute (≤14 days)**

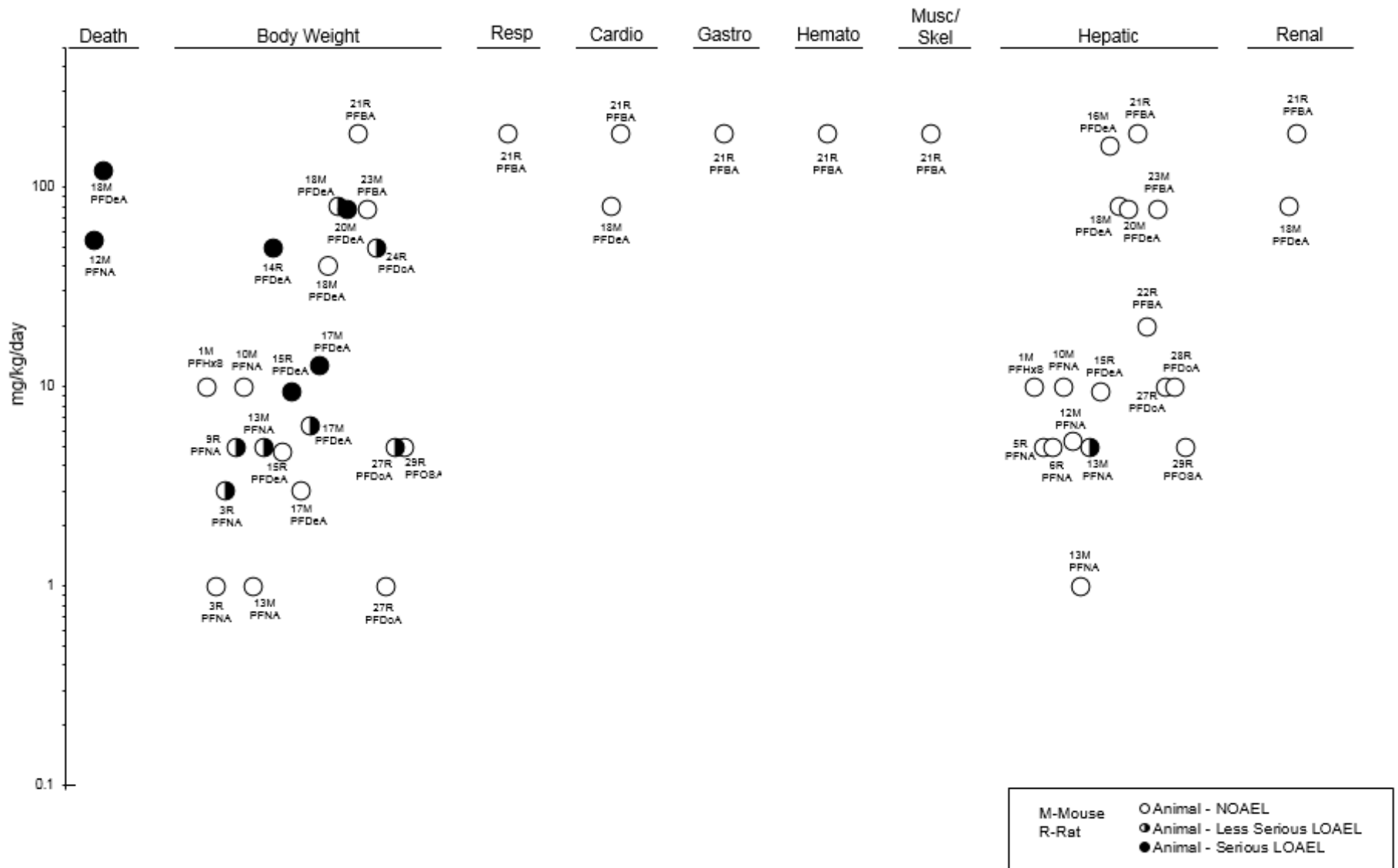

2. HEALTH EFFECTS

Figure 2-8. Levels of Significant Exposure to Other Perfluoroalkyls – Oral Acute (≤14 days)

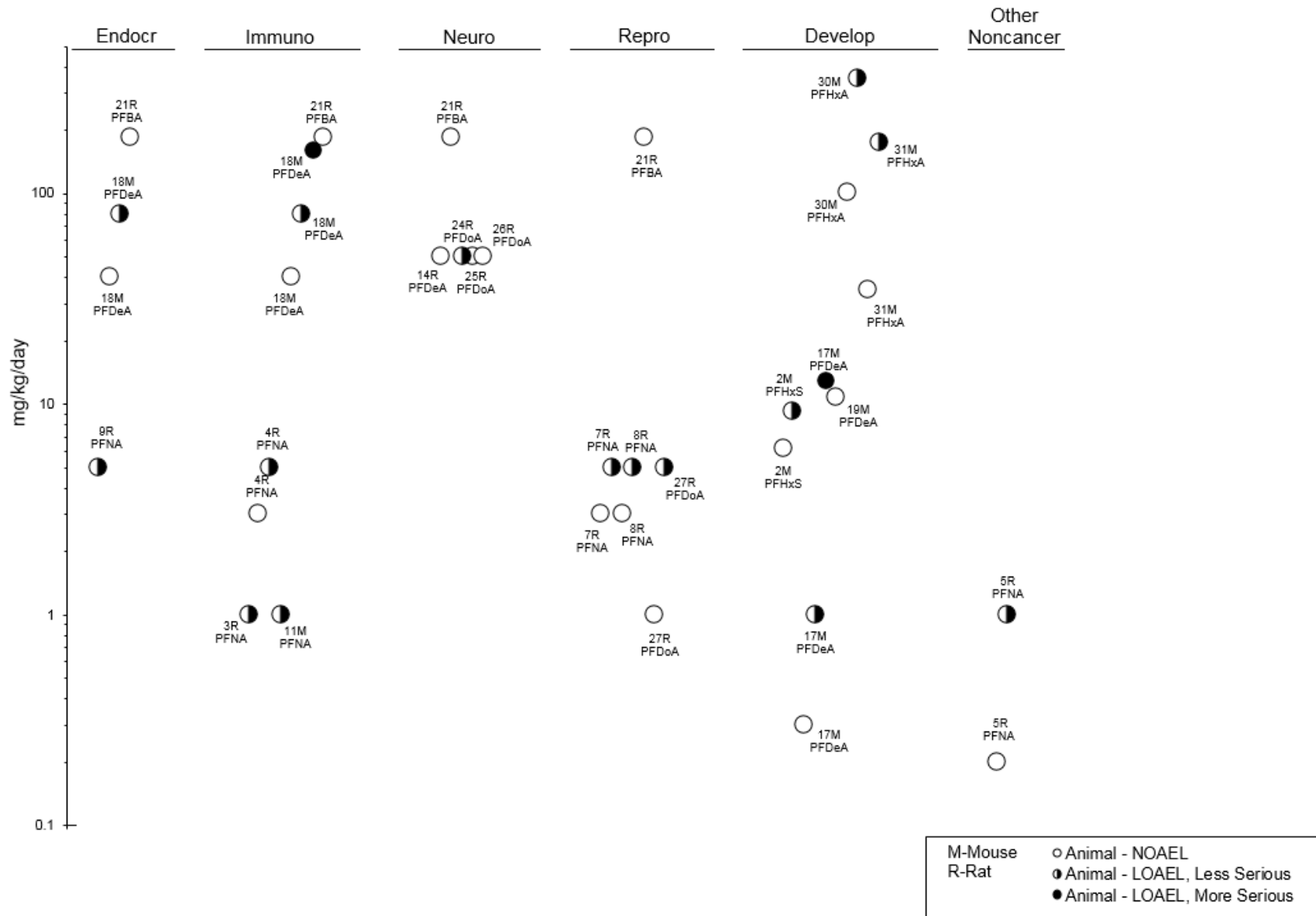

2. HEALTH EFFECTS

Figure 2-8. Levels of Significant Exposure to Other Perfluoroalkyls – Oral Intermediate (15–364 days)



2. HEALTH EFFECTS

Figure 2-8. Levels of Significant Exposure to Other Perfluoroalkyls – Oral Intermediate (15–364 days)

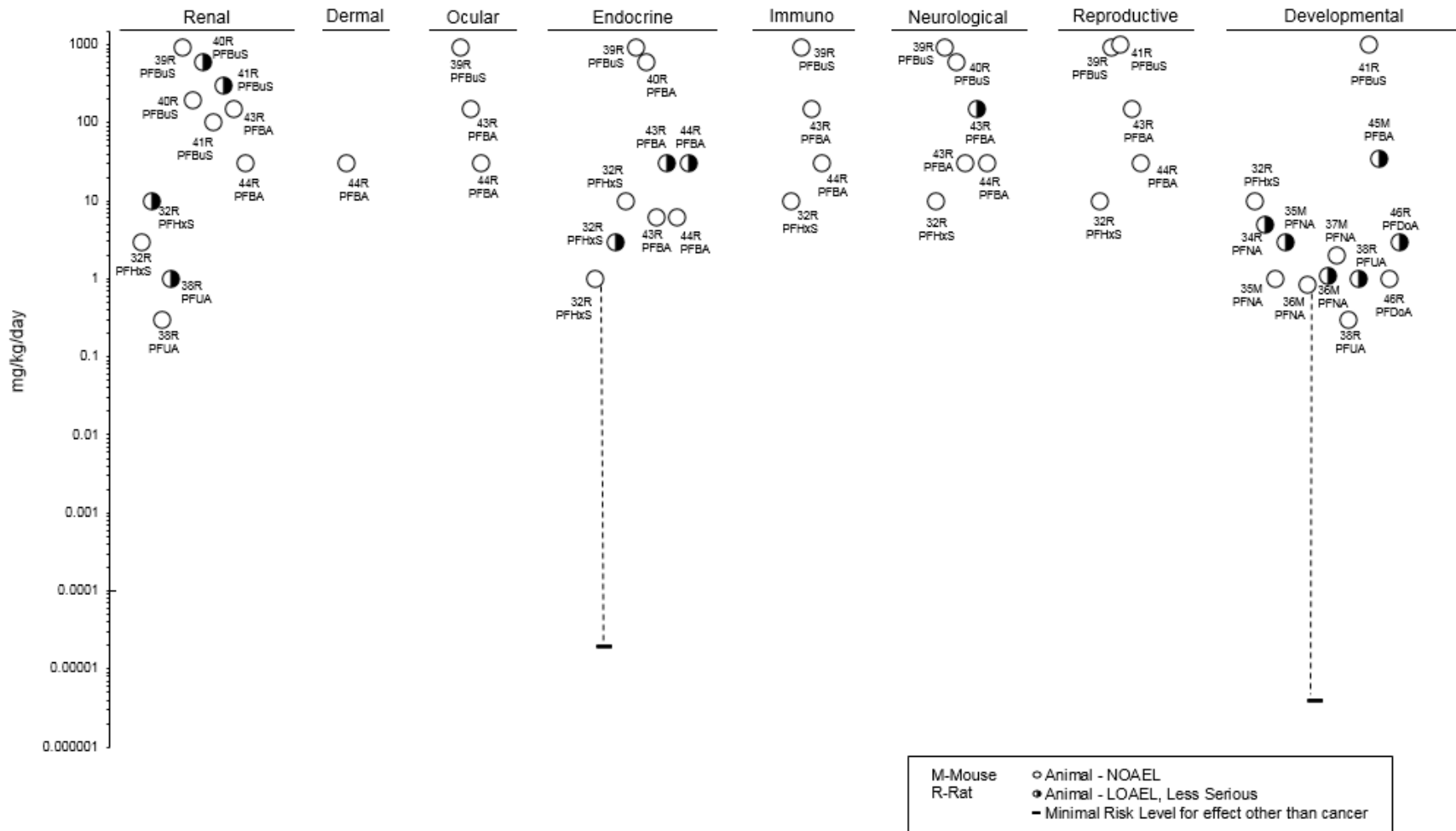

2. HEALTH EFFECTS

Figure 2-8. Levels of Significant Exposure to Other Perfluoroalkyls – Oral
 Chronic (≥365 days)

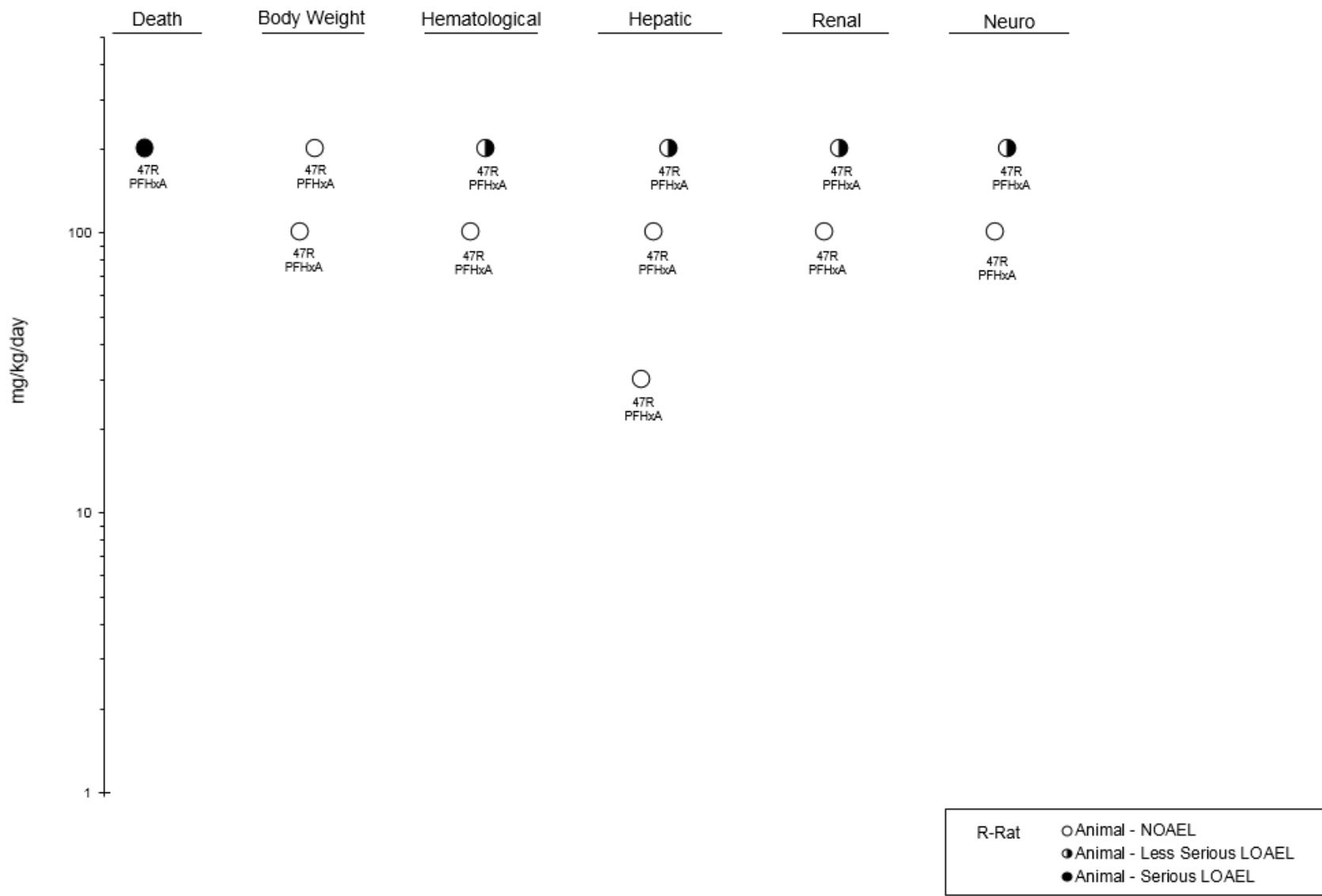

2. HEALTH EFFECTS

Table 2-6. Levels of Significant Exposure to PFOA – Dermal

Species (strain) No./group	Exposure parameters	Doses	Parameters monitored	Endpoint	NOAEL	Less serious LOAEL	Serious LOAEL	Effect
ACUTE EXPOSURE								
Rat (CD) 15 M,F	Once	3,000, 5,000, 7,500 mg/kg	CS, LE	Death			7,000 M	14-day LD ₅₀
				Bd Wt			3,000 M F	5–7% transient weight loss
				Dermal	3,000 M F	5,000 M F		Mild skin irritation
Kennedy 1985								
APFO								
LD ₅₀ in females was >7,500 mg/kg								
Rat (CD) 60 M	2 weeks 6 hours/day 5 days/week	0, 20, 200, 2,000 mg/kg/day	CS, BW, HE, BI, GN, HP	Bd Wt Resp Cardio Gastro Hemato Hepatic Renal Dermal Ocular Endocr Immuno Neuro Repro	20 M 2,000 M 2,000 M 2,000 M 2,000 M 2,000 M 20 M 2,000 M 20 M 2,000 M 2,000 M 2,000 M 2,000 M 2,000 M		200 M 2,000 M	14% weight loss Foci of coagulative necrosis Skin irritation; acute necrotizing dermatitis
Kennedy 1985								
APFO								
The immunological NOAEL is for histopathology of the spleen, thymus, and lymph nodes. The neurological NOAEL is for histopathology of the brain. The reproductive NOAEL is for histopathology of the testes.								
Mouse (BALB/c) 35 F	4 days 1 time/day	0, 0.25, 2.5, 6.25, 12.5, 25, 50 mg/kg/day	BW, OW, OF	Bd Wt Hepatic	50 F 2.5 F	6.25 F		52% increase in absolute liver weight
Fairley et al. 2007								
PFOA								

2. HEALTH EFFECTS

Table 2-6. Levels of Significant Exposure to PFOA – Dermal

Species (strain) No./group	Exposure parameters	Doses	Parameters monitored	Endpoint	NOAEL	Less serious LOAEL	Serious LOAEL	Effect
Mouse (BALB/c) 35 F	4 days 1 time/day	0, 12.5, 18.8, 25, 50 mg/kg/day	BW, OW, OF	Immuno	12.5	18.8		Increased serum IgE following ovalbumin challenge
Fairley et al. 2007								
PFOA								
Rabbit (albino) 6 NS	Once (NS)	100 mg	CS	Ocular		100		Moderate eye irritation
Griffith and Long 1980								
APFO								
Rabbit (albino) 6 NS	24 hours (NS)	500 mg	CS	Dermal	500			
Griffith and Long 1980								
APFO								
Rabbit (New Zealand) 17 M	Once	1,500, 3,000, 5,000, 7,500 mg/kg	CS, LE	Death		4,300		14-day LD ₅₀
Kennedy 1985								
APFO								

APFO = ammonium perfluorooctanoate; BI = biochemical changes; BW or Bd wt = body weight; Cardio = cardiovascular; CS = clinical signs; Endocr = endocrine; F = female(s); Gastro = gastrointestinal; GN = gross necropsy; HE or Hemato = hematology; HP = histopathology; Immuno = immunotoxicological; LD₅₀ = lethal dose, 50% kill; LE = lethality; LOAEL = lowest-observed-adverse-effect level; M = male(s); Neuro = neurological; NOAEL = no-observed-adverse-effect level; NS = not specified; OF = organ function; OW = organ weight; PFOA = perfluorooctanoic acid; Repro = reproductive; Resp = respiratory

2. HEALTH EFFECTS

2.2 DEATH

Overview. There are limited data regarding the lethality of perfluoroalkyls in humans; the available data primarily come from cohort mortality studies in workers. Laboratory animal studies have measured LC₅₀ and LD₅₀ values and reported deaths following inhalation, oral, or dermal exposure to perfluoroalkyls. These data are presented in Tables 2-1, 2-2, 2-3, 2-4, 2-5, and 2-6 and Figures 2-4, 2-5, 2-6, 2-7, and 2-8.

PFOA

Epidemiology Studies. Five occupational exposure studies at two PFOA manufacturing facilities have examined the possible associations between PFOA exposure and increases in mortality from all causes and have not found associations (Gilliland and Mandel 1993; Leonard 2006; Leonard et al. 2008; Lundin et al. 2009; Raleigh et al. 2014; Steenland and Woskie 2012). Some increases in disease-specific mortality have been observed; these data are discussed in subsequent sections of this chapter.

Laboratory Animal Studies. Limited data are available regarding death in animals following inhalation exposure to perfluoroalkyl compounds. Exposure of male and female rats to 18,600 mg/m³ ammonium perfluorooctanoate (APFO) dusts for 1 hour did not result in deaths during exposure or during a 14-day observation period (Griffith and Long 1980); APFO is the ammonium salt of PFOA. An LC₅₀ of 980 mg/m³ was reported in male CD rats exposed head-only to APFO dusts for 4 hours (Kennedy et al. 1986). Deaths occurred at all exposure levels (380–5,700 mg/m³) and all deaths occurred within 48 hours of exposure. Rats dying during exposure had hyperinflated lungs. A similar LC₅₀ value of 820 mg/m³ was calculated for male CD rats exposed nose-only to APFO dusts for 4 hours (Kinney et al. 1989). Unlike the Kennedy et al. (1986) study, one death was observed at 590 mg/m³ and no deaths occurred at 620 mg/m³. In a developmental study with APFO, whole-body exposure of 12 pregnant rats to 25 mg/m³, 6 hours/day during GDs 6–15 resulted in three deaths on GDs 12, 13, and 17 compared with no deaths in groups exposed to ≤10 mg/m³ (Staples et al. 1984). The cause of death was not reported.

Oral LD₅₀ values of 680 and 430 mg/kg were reported for male and female albino rats, respectively, administered single gavage doses of APFO and observed for 14 days (Griffith and Long 1980); all animals at the highest dose of 2,150 mg/kg died on day 1. Nonlethal signs observed included ptosis, piloerection, hypoactivity, decreased limb tone, ataxia, and corneal opacity. All signs were intermittent and there was no apparent dose-response relationship. In a 28-day dietary study with APFO in rats, all rats (males and females) in groups receiving approximately 1,000–1,130 mg/kg/day APFO died before

2. HEALTH EFFECTS

the end of the first week (Griffith and Long 1980). In a similar study in mice, all mice receiving doses of approximately 180–195 mg/kg/day died before the second week of the study (Griffith and Long 1980). In this study, doses of approximately 54–58 mg/kg/day APFO were lethal to 4/5 male and 5/5 female mice before the 4th week of the study.

In a 90-day gavage study, treatment of Rhesus monkeys with 100 mg/kg/day APFO by gavage resulted in the death of an unspecified number of animals (group size was 10/sex) on week 2 (Griffith and Long 1980). Doses of approximately 30 mg/kg/day were lethal to one male and two females during weeks 7–12. All animals that died in the 30 and 100 mg/kg/day groups had anorexia, emesis, black stool, pale face and gums, swollen face and eyes, hypoactivity, and prostration. Microscopic examination of tissues showed marked diffuse lipid depletion in the adrenals, slight to moderate hypocellularity of the bone marrow, moderate atrophy of the lymphoid follicles of the spleen, and moderate atrophy of the lymphoid follicles of the lymph nodes. No deaths occurred at 10 mg/kg/day. Deaths were also reported in intermediate-duration studies in *Cynomolgus* monkeys (Butenhoff et al. 2002). One monkey exposed to 30/20 mg/kg/day PFOA (12 days of exposure to 30 mg/kg/day, 10 days with no exposure, 23 weeks of exposure to 20 mg/kg/day) was sacrificed in moribund condition; the animal had a body weight loss of 12.5%, was notably hypoactive, and was cold to the touch (Butenhoff et al. 2002). The investigators noted that the death was likely due to the high toxicity of the 30 mg/kg/day dose. It is unclear if these deaths were compound-related; one monkey had pulmonary necrosis with a severe acute recurrence of pulmonary inflammation and the cause of morbidity for the second monkey was likely hyperkalemia. Neither effect was observed in the surviving animals.

The dermal LD₅₀ values for APFO were 7,000 mg/kg in male CD rats and >7,500 mg/kg in female rats (Kennedy 1985). The protocol consisted of application of PFOA (as an aqueous paste) to a clipped area of the skin, which immediately was covered with gauze pads and wrapped with rubber sheeting around the trunk. The contact period was 24 hours, at which time the application site was washed with water and the rats were observed for clinical signs for 14 days. Using the same protocol, the dermal LD₅₀ in male rabbits was 4,300 mg/kg (Kennedy 1985). Rabbits treated with 1,500 mg/kg showed skin irritation with formation of a large crusty area at the application site. No deaths occurred at 1,500 mg/kg. Rabbits treated with 3,000 mg/kg were lethargic and a single death occurred 7 days after treatment. At 5,000 mg/kg, deaths occurred in 3–4 days. These rabbits also showed nasal discharge, pallor, diarrhea, weakness, severe weight loss, and severe skin irritation along with areas of necrosis.

2. HEALTH EFFECTS

PFOS

Epidemiology Studies. One occupational exposure study evaluated the potential of PFOS to increase lethality; the study did not find increases in deaths from all causes in workers at a PFOS manufacturing facility (Alexander et al. 2003). Alterations in disease-specific mortality are discussed in subsequent sections of this chapter.

Laboratory Animal Studies. Unpublished information summarized by the Organization for Economic Co-operation and Development (OECD) (2002) indicates that an LC₅₀ of 5,200 mg/m³ was calculated for PFOS in male and female Sprague-Dawley rats exposed to airborne concentrations of PFOS dusts from 1,890 to 45,970 mg/m³ for 1 hour. All rats exposed to 24,090 mg/m³ died by day 6.

Unpublished information summarized by OECD (2002) indicate that LD₅₀ values of 233 and 271 mg/kg were calculated for male and female CD rats, respectively, following administration by gavage of single doses of up to 1,000 mg/kg of powdered PFOS suspended in an acetone/oil mixture and observed for 14 days. All rats (5/sex/dose group) dosed with ≥464 mg/kg PFOS died before the end of the study. The signs most frequently observed were hypoactivity, decreased limb tone, and ataxia. Gross necropsy showed stomach distension and signs of irritation of the glandular mucosa, and lung congestion. OECD (2002) also reported that a different study estimated that the acute oral LD₅₀ for PFOS by gavage in water in Sherman-Wistar albino rats was >50 and <1,500 mg/kg. An oral LD₅₀ value of 579 mg/kg/day was reported for male C57/BL/6 mice administered single gavage doses of PFOS and observed for 14 days (Xing et al. 2016). Mortality occurred within 3 hours of dosing, and moribund mice displayed signs of neurotoxicity (abdominal breathing, hind limb spasticity, tics, and urinary incontinence).

In a 26-week study, 2/6 male Cynomolgus monkeys administered 0.75 mg/kg/day PFOS via a capsule died or were sacrificed due to morbidity (Seacat et al. 2002). The cause of death in one monkey was pulmonary inflammation; the cause of morbidity in the second monkey was not determined, but the animal did have hyperkalemia.

PFNA

Laboratory Animal Studies. A LC₅₀ of 820 mg/m³ was identified in rats exposed to airborne PFNA for 4 hours (Kinney et al. 1989). In a 14-day study, all mice administered approximately 54 mg/kg/day PFNA died before the study period ended; no deaths occurred at 5.3 mg/kg/day (Kennedy 1987).

2. HEALTH EFFECTS

PFDeA

Laboratory Animal Studies. An LD₅₀ of 120 mg/kg was estimated for PFDeA in female C57BL/6N mice administered single doses between 20 and 320 mg/kg/day PFDeA by gavage in corn oil and observed for 30 days (Harris et al. 1989). All mice receiving 160 or 320 mg/kg were dead by 14 days; no mice died at ≤80 mg/kg PFDeA. Early death was associated with mural thrombosis in the left ventricle of the heart. Without providing any details, George and Andersen (1986) reported that the 30-day oral LD₅₀ for PFDeA in male Fischer-344 rats was 57 mg/kg.

PFHxA

Laboratory Animal Studies. Decreased survival was observed in female Sprague-Dawley rats administered 200 mg/kg/day PFHxA via gavage in a 104-week study (Klaunig et al. 2015). There was no significant effect on survival rates of males. Animals in the 200 mg/kg/day dose group had rales and increased incidence of struggling behavior.

2.3 BODY WEIGHT

Overview. Epidemiology studies have examined the possible associations between *in utero* and/or early life exposure to perfluoroalkyls and body weight, body mass index (BMI), etc. Other studies have examined possible associations between serum perfluoroalkyl levels in older children or adults and body weight, adiposity markers, and the risk of being overweight or obese. The results of the epidemiology studies are summarized in Table 2-7, with more detailed descriptions presented in the *Supporting Document for Epidemiological Studies for Perfluoroalkyls*, Table 1. Animal studies have evaluated changes in body weight, including maternal body weight, in response to inhalation, oral, or dermal exposure to perfluoroalkyls; these data are summarized in Tables 2-1, 2-2, 2-3, 2-4, 2-5, and 2-6 and Figures 2-4, 2-5, 2-6, 2-7, and 2-8.

PFOA

Epidemiology Studies. Mixed results were found in studies of monitoring infant growth from 1 to 12 months of age. Andersen et al. (2010) found an inverse association between maternal serum PFOA and body weight and BMI in male infants at 5 and 12 months of age; no associations were found in girls.

2. HEALTH EFFECTS

Table 2-7. Summary of Childhood Growth in Humans^a

Reference and study population ^b	Serum perfluoroalkyl level	Outcome evaluated	Result ^c
PFOA			
Barry et al. 2014 Community (C8) (n=8,764 20–40 year olds)	164.6 and 194.3 ng/mL (estimated early life median PFOA)	Overweight or obesity at age 20–40 years	OR 0.9 (0.7–1.1), males OR 0.9 (0.7–1.1), females
Andersen et al. 2010 General population (n=1,010 infants)	5.21 ng/mL (maternal median PFOA)	Body weight (age 5 and 12 months)	Inverse association (p<0.05)*, boys NS (p>0.05), girls
		BMI (age 5 and 12 months)	Inverse association (p<0.05)*, boys NS (p>0.05), girls
		Height (age 5 and 12 months)	NS (p>0.05), boys NS (p>0.05), girls
Andersen et al. 2013 General population (n=811 children aged 7 years)	5.25 ng/mL (maternal median PFOA)	BMI	NS (p>0.05)
		Waist circumference	NS (p>0.05)
Braun et al. 2016a, 2016b General population (n=204 children)	5.3 ng/mL (maternal median PFOA)	Changes in BMI scores between 2 and 8 years of age	Association (p=0.03)*
		Overweight/obesity risk	RR 1.54 (0.77–3.07), 3 rd tertile
de Cock et al. 2014 General population (n=89 infants aged 1– 11 months)	0.9402 ng/mL (cord blood mean PFOA)	Weight	NS (p=0.350)
		Height	NS (p=0.045)
		BMI	NS (p=0.813)
		Head circumference	NS (p=0.774)
Halldorsson et al. 2012 General population (n=665 20 year olds)	3.7 and 5.8 ng/mL (maternal median PFOA and 4 th quartile median)	BMI	Association (p=0.001)*, females
		Waist circumference	Association (p=0.006)*, females
		Overweight risk	RR 3.1 (1.4–6.9)*, females 4th quartile
		High waist circumference	RR 3.0 (1.3–6.8)*, females 4th quartile

2. HEALTH EFFECTS

Table 2-7. Summary of Childhood Growth in Humans^a

Reference and study population ^b	Serum perfluoroalkyl level	Outcome evaluated	Result ^c
Høyer et al. 2015b General population (n=1,122 children aged 5–9 years; n=531 for Greenland cohort and n=491 for Ukraine cohort)	2.2–5.1 and 1.1–9.8 ng/mL (maternal 3 rd tertile PFOA for Greenland and Ukraine cohorts)	Overweight Greenland cohort Ukraine cohort	RR 1.23 (0.87–1.74), 3 rd tertile RR 0.78 (0.47–1.29), 3 rd tertile
		Waist-to-height ratio >0.5 Greenland cohort Ukraine cohort	RR 1.18 (0.80–1.74), 3 rd tertile RR 1.11 (0.48–2.57), 3 rd tertile
Timmermann et al. 2014 General population (n=499 8–10-year-old children)	9.3 ng/mL (mean PFOA)	Adiposity markers	NS (p>0.05), per 10 ng/mL PFOA increase
Wang et al. 2016 General population (n=117 boys and 106 girls examined at 2, 5, 8, and 11 years of age)	2.37 and 2.34 ng/mL (median maternal PFOA for boys and girls)	Growth during childhood	NS (p>0.05)
PFOS			
Andersen et al. 2010 General population (n=1,010 infants)	33.8 ng/mL (maternal median PFOS)	Body weight (age 5 months)	NS (p>0.05), boys NS (p>0.05), girls
		Body weight (age 12 months)	Inverse association (p<0.05)* , boys NS (p>0.05), girls
		BMI (age 5 months)	NS, boys NS (p>0.05), girls
		BMI (age 12 months)	Inverse association (p<0.05)* , boys NS (p>0.05), girls
		Height (age 5 and 12 months)	NS (p>0.05), boys NS (p>0.05), girls
Andersen et al. 2013 General population (n=811 children aged 7 years)	33.8 ng/mL (maternal median PFOS)	BMI	NS (p>0.05)
		Waist circumference	NS (p>0.05)

2. HEALTH EFFECTS

Table 2-7. Summary of Childhood Growth in Humans^a

Reference and study population ^b	Serum perfluoroalkyl level	Outcome evaluated	Result ^c
Braun et al. 2016a, 2016b	13 ng/mL (maternal median PFOS)	Changes in BMI scores between 2 and 8 years of age	NS (p>0.23)
General population (n=204 children)		Overweight/obesity risk	RR 1.08 (0.59–1.95), 3 rd tertile
Halldorsson et al. 2012	21.5 and 5.8 ng/mL (maternal median PFOS)	BMI	NS (p>0.56)
General population (n=665 20 year olds)		Waist circumference	NS (p>0.56)
Høyer et al. 2015b	23.9–87.3 and 5.9–18.1 ng/mL (maternal 3 rd tertile PFOS for Greenland and Ukraine cohorts)	Overweight Greenland cohort Ukraine cohort	RR 0.84 (0.61–1.14), 3 rd tertile RR 0.89 (0.57–1.37), 3 rd tertile
General population (n=1,122 children aged 5–9 years; n=531 for Greenland cohort and n=491 for Ukraine cohort)		Waist-to-height ratio >0.5 Greenland cohort Ukraine cohort	RR 1.22 (0.86–1.74), 3 rd tertile RR 1.44 (0.62–3.31), 3 rd tertile
Maisonet et al. 2012	>23.0 ng/mL (maternal PFOS 3 rd tertile)	Body weight at 20 months (adjusted for birth weight)	β 438.4 g (71.09–805.65 g, p=0.0195)*, 3rd tertile
General population (n=447 girls)			
Timmermann et al. 2014	41.5 ng/mL (mean PFOS)	Adiposity markers	NS (p>0.05), per 10 ng/mL PFOS increase
General population (n=499 8–10-year-old children)			
PFHxS			
Braun et al. 2016a, 2016b	1.4 ng/mL (maternal median PFHxS)	Changes in BMI scores between 2 and 8 years of age	NS (p>0.23)
General population (n=204 children)		Overweight/obesity risk	RR 1.48 (0.75–2.96), 3 rd tertile
Maisonet et al. 2012	1.6 ng/mL (maternal median PFHxS)	Body weight at 20 months	NS (p=0.4375 for trend)
General population (n=447 girls)			

2. HEALTH EFFECTS

Table 2-7. Summary of Childhood Growth in Humans^a

Reference and study population ^b	Serum perfluoroalkyl level	Outcome evaluated	Result ^c
PFNA			
Braun et al. 2016a, 2016b General population (n=204 children)	0.9 ng/mL (maternal median PFNA)	Changes in BMI scores between 2 and 8 years of age Overweight/obesity risk	NS (p>0.23) RR 1.26 (0.64–2.48), 3 rd tertile
Halldorsson et al. 2012 General population (n=665 20 year olds)	0.3 ng/mL (maternal median PFNA)	BMI Waist circumference	NS (p>0.56) NS (p>0.56)
Wang et al. 2016 General population (n=117 boys and 106 girls examined at 2, 5, 8, and 11 years of age)	1.55 and 1.58 ng/mL (median maternal PFNA for boys and girls)	Growth during childhood	NS (p>0.05)
PFDeA			
Wang et al. 2016 General population (n=117 boys and 106 girls examined at 2, 5, 8, and 11 years of age)	0.46 and 0.43 ng/mL (median maternal PFDeA for boys and girls)	Growth during childhood Weight Height	Inverse association (p<0.05)*, girls Inverse association (p<0.05)*, girls
PFUA			
Wang et al. 2016 General population (n=117 boys and 106 girls examined at 2, 5, 8, and 11 years of age)	3.52 and 3.31 ng/mL (median maternal PFUA for boys and girls)	Growth during childhood Weight Height	Inverse association (p<0.05)*, girls Inverse association (p<0.05)*, girls
PFDaA			
Wang et al. 2016 General population (n=117 boys and 106 girls examined at 2, 5, 8, and 11 years of age)	0.37 and 0.37 ng/mL (median maternal PFDaA for boys and girls)	Growth during childhood Weight Height	Inverse association (p<0.05)*, girls Inverse association (p<0.05)*, girls

2. HEALTH EFFECTS

Table 2-7. Summary of Childhood Growth in Humans^a

Reference and study population ^b	Serum perfluoroalkyl level	Outcome evaluated	Result ^c
PFOSA			
Halldorsson et al. 2012	1.1 ng/mL (maternal median PFOSA)	BMI	NS (p>0.56)
General population (n=665 20 year olds)		Waist circumference	NS (p>0.56)

^aSee the *Supporting Document for Epidemiological Studies for Perfluoroalkyls*, Table 1 for more detailed descriptions of studies.

^bParticipants in occupational exposure may have also lived near the site and received residential exposure; community exposure studies involved subjects living near PFOA facilities with known exposure to high levels of PFOA.

^cAsterisk indicates association with perfluoroalkyl compound; unless otherwise specified, values in parenthesis are 95% confidence intervals.

BMI = body mass index; HR = hazard ratio; NR = not reported; NS = not significant; OR = odds ratio; PFDeA = perfluorodecanoic acid; PFDoA = perfluorododecanoic acid; PFHxS = perfluorohexane sulfonic acid; PFNA = perfluorononanoic acid; PFOA = perfluorooctanoic acid; PFOS = perfluorooctane sulfonic acid; PFOSA = perfluorooctane sulfonamide; PFUA = perfluoroundecanoic acid; RR = relative risk

2. HEALTH EFFECTS

A study by de Cock et al. (2014) of infants 1–11 months of age did not find associations between cord blood PFOA levels and weight, height, or BMI. One study of children (Braun et al. 2016a) found an association between changes in BMI scores between ages 2 and 8 years and maternal PFOA levels; however, there was no increase in the risk of being overweight or obese. Other studies in children (2–11 years of age) found no associations between maternal PFOA or cord blood PFOA and growth during childhood (Wang et al. 2016), risk of being overweight (Andersen et al. 2013; Braun et al. 2016a; Høyer et al. 2015b), or risk of having a waist-to-height ratio of >0.5 (Høyer et al. 2015b). In a study of children aged 8–10 years, no associations were found between plasma PFOA levels and markers of adiposity (BMI, skinfold thickness, waist circumference, adiponectin levels, and leptin levels) (Timmermann et al. 2014).

Two studies in adults have not found associations between PFOA and body weight gain. A general population study of 20-year-old females found associations between maternal PFOA levels and BMI and waist circumferences, and increases in the risk of being overweight and having a high waist circumference (Halldorsson et al. 2012); these associations were not observed in males. No increases in the risk of being overweight or obese were observed in male or female C8 participants (20–40 years of age) when estimated early life PFOA exposure was used as the exposure metric (Barry et al. 2014).

Overall, the available epidemiology data do not suggest a connection between serum PFOA levels and body weight or risk of being overweight/obese.

Laboratory Animal Studies. Male rats that survived a 4-hour inhalation exposure to 380 mg/m³ APFO dusts lost weight for 1–2 days after exposure, but resumed normal weight gain thereafter (Kennedy et al. 1986). Male rats exposed via inhalation intermittently to 84 mg/m³ APFO dusts for 2 weeks lost approximately 7% of their body weight by day 5 of exposure (250 g at start of study, 237 g on day 5) (Kennedy et al. 1986), but recovered by day 16 after exposure ceased. Nose-only exposure of male CD rats to 590 mg/m³ ammonium perfluorononanoate dusts for 4 hours resulted in 18 and 36% reductions in body weight 5 and 12 days after exposure, respectively (Kinney et al. 1989). Inhalation exposure to 67 mg/m³ had no significant effect on body weight. In a developmental study, inhalation exposure of pregnant rats to 25 mg/m³ APFO dusts during GDs 6–15 induced a 37% reduction in body weight gain relative to controls during the exposure period (Staples et al. 1984); in a pair-fed group, the reduction of weight gain during the same period was 61% relative to *ad libitum* controls.

2. HEALTH EFFECTS

Reductions in body weight or body weight gain are typical, although not particularly sensitive, responses of rodents to oral exposure to perfluoroalkyl compounds. In many cases, this effect is not associated with reduced food intake, and in some cases, exposed animals have shown an increase in relative food consumption (grams of food/grams of body weight) relative to controls. For example, in acute-duration studies, rats administered 25 mg/kg/day APFO for 14 days had a mean terminal body weight 14% lower than controls (Cook et al. 1992). Administration of 50 mg/kg/day APFO for 7 days resulted in 17% weight loss; a similar decrease was observed in a pair-fed group (Pastoor et al. 1987). In mice, doses of approximately 25–30 mg/kg/day PFOA in the food for 7 days reduced terminal body weight by >10% relative to controls without a significant reduction in food intake (Xie et al. 2003; Yang et al. 2000, 2002a, 2002b). However, administration of the same dose to PPAR α -null mice did not cause a reduction in weight gain, suggesting that the effect on body weight is a specific effect of peroxisome proliferators possibly due to increased fat utilization (Yang et al. 2002b). In general, body weight recovered once treatment ceased.

Intermediate-duration oral studies in rats have also reported reduced body weight gain with doses ≥ 10 mg/kg/day APFO (Butenhoff et al. 2004b; Griffith and Long 1980). In the former study, mean absolute food consumption was decreased, but mean relative food consumption was increased. In a 2-year bioassay, body weight gain in rats dosed with 15 mg/kg/day PFOA was reduced >10% relative to controls at the 1 year mark and at termination (Biegel et al. 2001). Similar observations have been made in mice dosed with approximately ≥ 18 mg/kg/day APFO for 28 days (Griffith and Long 1980) and in pregnant mice dosed with ≥ 10 mg/kg/day APFO during GDs 1–17 (Lau et al. 2006). A study comparing wild-type mice and PPAR α knockout mice (DeWitt et al. 2016) found a decrease in body weight gain in the wild-type mice, but not in the knockout mice. A 90-day and a 26-week study in monkeys also reported significant reductions in body weight gain or weight loss associated with decreased food consumption at dose levels in the range of 20–30 mg/kg/day APFO (Butenhoff et al. 2002; Griffith and Long 1980), but a 4-week study in monkeys dosed with 20 mg/kg/day PFOA did not (Thomford 2001).

Transient weight loss was reported in rats applied 3,000 mg/kg APFO to the shaven skin for 24 hours (Kennedy 1985). In the 2-week study, rats in the 200 and 2,000 mg/kg/day groups lost weight during the treatment period (14 and 24%, respectively, on test day 10), but body weights were comparable to control after 42 days of recovery. No changes in body weight were reported in mice applied up to 50 mg/kg/day PFOA daily for 4 days on the dorsal surface of the ears (Fairley et al. 2007).

2. HEALTH EFFECTS

PFOS

Epidemiology Studies. General population studies have evaluated body weight, height, and BMI in infants, children, and adults to assess whether there were links between growth and maternal serum PFOS levels. Andersen et al. (2010) found that maternal PFOS levels were inversely related to body weight and BMI in 12-month-old male infants; no associations were found in females at 12 months of age or in males and females at 5 months of age. The magnitude of the effect on body weight in the boys was small, 9 g per 1 ng/mL increase in maternal serum PFOS level. Maisonet et al. (2012) found that at 20 months of age, girls whose mothers had serum PFOS levels in the 3rd tertile weighed 438 g more than those in the first tertile. Studies in children (Andersen et al. 2013; Braun et al. 2016a; Høyer et al. 2015b) or young adults (Halldorsson et al. 2012) did not find associations between maternal PFOS levels and BMI, waist circumference, and/or risk of being overweight. No associations between plasma PFOS and markers of adiposity (BMI, skinfold thickness, waist circumference, adiponectin levels, and leptin levels) were found in a study of children aged 8–10 years (Timmermann et al. 2014). Overall, the epidemiology studies do not suggest a connection between serum PFOS and body weight or the risk of being overweight/obese.

Laboratory Animal Studies. Dietary treatment of rats with 15 mg/kg/day PFOS (only dose level tested) for 7 days did not significantly alter body weight (Haughom and Spydevold 1992). Oral treatment of pregnant rats with 25 mg/kg/day PFOS on GDs 2–5 or 6–9 resulted in weight loss during treatment, whereas treatment on GDs 10–13, 14–17, or 17–20 resulted in significant reductions in weight gain (Grasty et al. 2003). In pregnant mice, oral dosing with up to 6 mg/kg/day PFOS on GDs 6–18 or 12–18 did not significantly affect body weight (Fuentes et al. 2006, 2007b). Pregnant rabbits appeared to be more sensitive as oral doses of 1 mg/kg/day on GDs 6–20 caused a 21% reduction in weight gain during treatment without altering food consumption (Case et al. 2001).

Reductions in body weight gain of >10% have been reported in intermediate-duration studies in rats dosed with ≥ 2 mg/kg/day PFOS associated with reductions in mean absolute and relative food consumption (Luebker et al. 2005a, 2005b). In a developmental toxicity study, treatment of pregnant rats with ≥ 2 mg/kg/day PFOS on GDs 2–20 resulted in significant reductions in body weight gain, which were associated with significant reductions in mean absolute food and water consumption (Thibodeaux et al. 2003). In a 4-week study, treatment of Cynomolgus monkeys with up to 2 mg/kg/day, administered via a capsule, did not affect body weight gain (Thomford 2002a). In a 26-week study in Cynomolgus monkeys, the highest dose of PFOS tested, 0.75 mg/kg/day, produced a 13.5% reduction in final body weight, at which time the mean concentration of PFOS in serum was 172 $\mu\text{g/mL}$ (Seacat et al. 2002). In a

2. HEALTH EFFECTS

2-year dietary study in rats, final mean body weight of females that received doses of approximately 1.04 mg/kg/day PFOS was 14% lower than controls; this could have been due, in part, to a tendency of decreased food consumption during weeks 28 through 104 of the study (Butenhoff et al. 2012b; Thomford 2002b). No significant effect (<10% difference with controls) was seen in females dosed with ≤ 0.25 mg/kg/day PFOS.

PFHxS

Epidemiology Studies. Two studies have evaluated the influence of *in utero* PFHxS exposure on childhood growth and found no associations between maternal PFHxS levels and body weight at 20 months of age (Maisonet et al. 2012), changes in BMI scores between 2 and 8 years of age (Braun et al. 2016a), or the risk of childhood overweight/obesity (Braun et al. 2016a).

Laboratory Animal Studies. Treatment of rats with up to 10 mg/kg/day PFHxS by gavage for 40–60 days did not significantly affect body weight (Butenhoff et al. 2009a; Hoberman and York 2003); the mean terminal body weights were within 10% of the body weight of the control group. Food consumption was not affected by treatment with PFHxS.

PFNA

Epidemiology Studies. Several studies have examined the influence of maternal PFNA levels on childhood growth. These studies did not find associations between maternal PFNA levels and growth during childhood (Wang et al. 2016), BMI (Braun et al. 2016a; Halldorsson et al. 2012), or overweight/obesity risk (Braun et al. 2016a).

Laboratory Animal Studies. Decreases in body weight gain have been observed in rats administered ≥ 3 mg/kg/day for 14 days (Fang et al. 2009, 2010; Hadrup et al. 2016) and in mice administered 5 mg/kg/day for 14 days (Wang et al. 2015a). The NOAEL for body weight effects was 1 mg/kg/day for both species. In intermediate-duration developmental toxicity studies, decreases in body weight were observed at 5 mg/kg/day in rats (Rogers et al. 2014) and weight loss was observed in mice at 10 mg/kg/day (Das et al. 2015). No alterations in maternal weight gain were observed in mice at 2.0 mg/kg/day (Wolf et al. 2010).

2. HEALTH EFFECTS

PFDeA

Epidemiology Studies. One study examined the effect of PFDeA levels on childhood growth; Wang et al. (2016) reported decreases in weight and height in girls associated with increasing maternal serum PFDeA levels.

Laboratory Animal Studies. Ten days following administration of a single gavage dose of 50 mg/kg, weight loss was observed in rats (Kawabata et al. 2017). In a 1-week study, exposure to 9.5 mg/kg/day PFDeA in the diet resulted in a 32% weight loss in rats (Kawashima et al. 1995); the NOAEL was 4.7 mg/kg/day.

Body weight of female C57BL/6N mice administered a single gavage dose of 80 mg/kg PFDeA was reduced 12% relative to controls 30 days after dosing (Harris et al. 1989); no significant effect was seen at 40 mg/kg PFDeA. In a developmental study, pregnant mice dosed with 6.4 mg/kg/day PFDeA on GDs 6–15 gained 92% less weight (adjusted weight) on GDs 6–18 than controls; mice dosed with 12.8 mg/kg/day lost weight (Harris and Birnbaum 1989). Food consumption data were not provided in any of these studies. Weight loss was also observed in C57BL/6N mice exposed to 78 mg/kg/day PFDeA in the diet for 10 days (Permadi et al. 1992, 1993).

PFUA

Epidemiology Studies. Wang et al. (2016) found an inverse association between maternal serum PFUA levels and weight and height in girls.

Laboratory Animal Studies. Decreases in body weight gain (10% in males and 23% in females) were observed in rats exposed to 1.0 mg/kg/day in a 41–46-day developmental toxicity study (Takahashi et al. 2014).

PFBuS

Laboratory Animal Studies. No significant alterations in body weight gain were observed in Sprague-Dawley rats administered ≤ 900 mg/kg/day PFBuS via gavage for 28 days (3M 2001) or in Sprague-Dawley rats administered $\leq 1,000$ mg/kg/day PFBuS via gavage for at least 70 days (Lieder et al. 2009b).

2. HEALTH EFFECTS

PFBA

Laboratory Animal Studies. Alterations in body weight do not appear to be a sensitive outcome of PFBA exposure in rats or mice. No alterations in body weight gain were observed in Sprague-Dawley rats administered 184 mg/kg/day PFBA via gavage for 5 days (3M 2007a), C57BL/6 mice exposed to 78 mg/kg/day PFBA in the diet for 10 days (Permadi et al. 1992, 1993), Sprague-Dawley rats administered 150 mg/kg/day PFBA via gavage for 28 days (Butenhoff et al. 2012a; van Otterdijk 2007a), or Sprague-Dawley rats administered 30 mg/kg/day PFBA via gavage for 90 days (Butenhoff et al. 2012a; van Otterdijk 2007b).

PFDoA

Epidemiology Studies. Wang et al. (2016) found an inverse association between maternal serum PFDoA levels and growth (weight and height) in girls.

Laboratory Animal Studies. Dosing of Sprague-Dawley rats with 5 mg/kg/day PFDoA by gavage for 14 days resulted in a 25% reduction in final body weight relative to a control group or 7% loss of body weight compared with the starting body weight (Shi et al. 2007). Decreases in body weight gain (measured 10 days postexposure) were also observed in rats administered a single gavage dose of 50 mg/kg PFDoA (Kawabata et al. 2017).

PFHxA

Laboratory Animal Studies. Gavage administration of 100 or 200 mg/kg/day for 2 years did not result in alterations in body weight gain in male or female rats, respectively (Klaunig et al. 2015).

PFOSA

Epidemiology Studies. Halldorsson et al. (2012) did not find associations between maternal serum PFOSA levels and BMI or waist circumference in 20 year olds.

Laboratory Animal Studies. No alterations in body weight were observed in Sprague-Dawley rats following a single gavage dose of 5 mg/kg PFOSA (Seacat and Luebker 2000).

2. HEALTH EFFECTS

2.4 RESPIRATORY

Overview. A small number of epidemiology studies have examined the potential of perfluoroalkyl compounds to damage the respiratory tract; detailed descriptions of these studies are presented in the *Supporting Document for Epidemiological Studies for Perfluoroalkyls*, Table 2. These studies were primarily conducted in PFOA workers or in residents of nearby communities. The possible associations between perfluoroalkyl exposure and asthma are discussed along with other immune effects in Section 2.14. Studies in laboratory animals have examined the potential for perfluoroalkyls to induce histological lesions in the lungs following inhalation (see Tables 2-1 and 2-2) or oral exposure (see Tables 2-3, 2-4, and 2-5).

PFOA

Epidemiology Studies. There are limited data on the potential of PFOA to damage the respiratory tract. Pulmonary function tests and chest roentgenograms conducted on workers potentially exposed to PFOA at the Washington Works fluoropolymers production facility were within normal limits (Sakr et al. 2007b); the serum PFOA levels ranged from 5 to 9,550 ng/mL. Another study of workers at this facility did not find an association between estimated cumulative serum PFOA levels and the risk of chronic obstructive pulmonary disease (Steenland et al. 2015). In contrast, a study of residents living near this facility found an increase in the risk of chronic bronchitis (standard prevalence ratio [SPR] of 3.60, 95% confidence interval [CI] 2.92–4.44) and shortness of breath (SPR 2.05, 95% CI 1.70–2.46) (Anderson-Mahoney et al. 2008); it is noted that results were based on health surveys, and some of the subjects also worked at the facility. Summaries of these studies are presented in the *Supporting Document for Epidemiological Studies for Perfluoroalkyls*, Table 2.

Laboratory Animal Studies. Inhalation exposure of male and female rats to 18,600 mg/m³ APFO dusts for 1 hour induced a red nasal discharge and dry rales (Griffith and Long 1980). Necropsy conducted 14 days after exposure showed bilateral mottling of the lungs in 8 out of 10 rats. Head-only exposure for 4 hours to 380 mg/m³ APFO dusts, a concentration that was lethal to some rats, produced pulmonary edema, which disappeared within 1 week of exposure (Kennedy et al. 1986). Examination of the lungs and trachea from rats exposed head-only to up to 84 mg/m³ APFO dusts 6 hours/day, 5 days/week for 2 weeks showed no significant gross or microscopic alterations (Kennedy et al. 1986). Male CD rats exposed nose-only to ≥590 mg/m³ ammonium perfluorononanoate dusts for 4 hours exhibited lung noise and labored breathing during exposure and throughout a 12-day recovery period (Kinney et al. 1989).

2. HEALTH EFFECTS

Oral dosing of male and female CD rats with ≤ 110 mg/kg/day APFO did not induce gross or microscopic changes in the lungs (Griffith and Long 1980; Perkins et al. 2004). Dosing for 2 years with 15 mg/kg/day APFO increased the incidence of lung hemorrhage in males (3M 1983). The incidences were 10/50, 14/50, and 22/50 for groups receiving doses of 0, 1.5, and 15 mg/kg/day, respectively. Pair-wise comparison between controls and high-dose groups revealed a statistically significant difference ($p < 0.05$). In a study in monkeys administered up to 20 mg/kg/day APFO, administered via a capsule, for 26 weeks, no signs of respiratory problems were observed during the study and no gross or microscopic alterations in the lungs and trachea were observed at termination (Butenhoff et al. 2002).

No gross or microscopic alterations were found in the lung and trachea from male CD rats following application of up to 2,000 mg/kg/day APFO as an aqueous paste to an area of the shaven back (approximately 15% of the total body surface) 6 hours/day, 5 days/week for 2 weeks (Kennedy 1985).

PFOS

Laboratory Animal Studies. Unpublished data summarized by OECD (2002) indicate that inhalation exposure of rats to concentrations of PFOS between 1,890 and 45,970 mg/m³ for 1 hour induced dry rales and other breathing disturbances.

Dosing of Cynomolgus monkeys with up to 2 mg/kg/day PFOS for 4 weeks had no effect of the gross or microscopic morphology of the lungs (Thomford 2002a). Administration of doses of up to 0.75 mg/kg/day of PFOS (potassium salt) administered via a capsule to Cynomolgus monkeys for 26 weeks did not produce any gross or microscopic alterations in the lungs or the trachea (Seacat et al. 2002). Dosing rats with up to 1.04 mg PFOS/kg/day in the diet for 104 weeks did not induce significant gross or microscopic alterations in the lungs or trachea (Butenhoff et al. 2012b; Thomford 2002b).

PFHxS

Laboratory Animal Studies. Examination of the respiratory tract of rats administered ≤ 10 mg/kg/day PFHxS by gavage in a reproductive study (40–60 days of dosing) showed no treatment-related effects (Butenhoff et al. 2009a; Hoberman and York 2003).

2. HEALTH EFFECTS

PFNA

Laboratory Animal Studies. Labored breathing during and after a 4-hour nose-only exposure to 590 mg/m³ PFNA was reported in rats (Kinney et al. 1989).

PFBuS

Laboratory Animal Studies. Administration of PFBuS at gavage doses of ≤900 mg/kg/day for 28 days or 600 mg/kg/day for 90 days had no significant effect on the gross or microscopic morphology of the lungs or trachea in rats (3M 2001; Lieder et al. 2009a); no increases in nasal lesions were observed in the 90-day study (Lieder et al. 2009a).

PFBA

Laboratory Animal Studies. Administration of PFBA to rats by gavage in doses ≤184 mg/kg/day for 5 days (3M 2007a), ≤150 mg/kg/day for 28 days (Butenhoff et al. 2012a; van Otterdijk 2007a), or ≤30 mg/kg/day for 90 days (Butenhoff et al. 2012a; van Otterdijk 2007b) did not cause morphological alterations in the respiratory tract.

2.5 CARDIOVASCULAR

Overview. Epidemiology and laboratory animal studies have evaluated the toxicity of perfluoroalkyls to the cardiovascular system. The epidemiology studies evaluated several cardiovascular outcomes including ischemic heart disease, cerebrovascular disease, stroke, cardiovascular disease, myocardial infarction, hypertension, and pregnancy-induced hypertension. The results of these studies are summarized in Table 2-8, with more detailed descriptions presented in the *Supporting Document for Epidemiological Studies for Perfluoroalkyls*, Table 3. The available occupational, community, and general population studies have not consistently found increases in the risk of heart disease or stroke that were associated with serum PFOA levels. Considerably less epidemiology data are available for other perfluoroalkyls; general population studies for PFOS, PFHxS, PFNA, PFDeA, PFUA, and PFHpA have not found increases in the risk of cardiovascular disease. Most of the available epidemiology studies did not find a link between serum PFOA and hypertension, and the one study for PFOS did not find an association. Although mixed results were found in studies of highly exposed community residents, the strongest methodological study (Darrow et al. 2013) found an increased risk of pregnancy-induced

2. HEALTH EFFECTS

hypertension that was associated with serum PFOA levels. Increases in the risk of pregnancy-induced hypertension associated with serum PFOS levels were also found in two community studies. General population studies have not found associations between serum PFHxS or PFDeA and pre-eclampsia; one study on PFUA found an inverse association.

Examination of the cardiovascular system in laboratory animals primarily consists of inhalation, oral, and dermal studies examining the heart for morphological alterations (see Tables 2-1, 2-3, 2-4, 2-5, and 2-6). The laboratory animal studies did not find increases in the incidence of histological alterations in the heart following exposure to PFOA, PFOS, PFHxS, PFDeA, PFBuS, or PFBA.

PFOA

Epidemiology Studies—Heart Disease. Possible associations between PFOA exposure and increased risk of heart disease have been examined in cohort mortality studies of workers, community members living near a PFOA facility, and the general population. Occupational exposure studies have not found increases in deaths from all heart disease, cerebrovascular disease, or ischemic heart disease when compared to U.S. general populations, state populations, and/or a population of workers at other company facilities (Leonard 2006; Lundin et al. 2009; Raleigh et al. 2014; Steenland and Woskie 2012). One occupational exposure study found an increase in the risk of cerebrovascular disease in workers with definite exposure for at least 6 months compared to an internal referent group (Lundin et al. 2009). However, other studies have not found increased risks of ischemic heart disease (Raleigh et al. 2014; Sakr et al. 2009), cerebrovascular disease (Raleigh et al. 2014), or coronary artery disease (Steenland et al. 2015). In another occupational exposure study, the investigators noted that electrocardiograms (EKGs) were within normal limits (Sakr et al. 2007b).

Studies of residents living near the Washington Works facility in West Virginia reported increased risks of self-reported cardiovascular disease (Anderson-Mahoney et al. 2008), angina (Anderson-Mahoney et al. 2008), myocardial infarction (Anderson-Mahoney et al. 2008), and stroke (Anderson-Mahoney et al. 2008; Simpson et al. 2013). It is noted that the Anderson-Mahoney et al. (2008) study did not measure serum PFOA levels; the incidences of self-reported diseases were compared to NHANES rates. Another community study of residents in this area did not find an increased risk of coronary artery disease (Winqvist and Steenland 2014a). Two general population studies have examined possible associations between serum PFOA and heart disease risks. A case-control study did not find increases in the risk of coronary artery disease in subjects with median serum PFOA levels of 4.2 ng/mL (cases) or 4.0 ng/mL

2. HEALTH EFFECTS

Table 2-8. Summary of Cardiovascular Outcomes in Humans^a

Reference and study population ^b	Serum perfluoroalkyl level	Outcome evaluated	Result ^c
PFOA			
Leonard 2006	5–9,550 ng/mL (PFOA range)	Heart disease deaths	SMR 110 (98–123)
Occupational (n=6,027)		Cerebrovascular disease deaths	SMR 86 (60–120)
		Ischemic heart disease deaths	SMR 109 (96–124)
Lundin et al. 2009	2,600–5,200 ng/mL (range of definite exposure group)	Heart disease deaths	SMR 0.7 (0.5–1.3)
Occupational (n=3,993)		Cerebrovascular disease deaths	SMR 1.6 (0.5–3.7)
		Ischemic heart disease deaths	SMR 0.8 (0.5–1.4)
		Cerebrovascular disease risk	HR 4.6 (1.3–17.0)* workers with definite exposure of ≥6 months HR 2.1 (1.0–4.6)* workers with definite exposure ≥5 years
Raleigh et al. 2014	Cumulative PFOA exposure	Ischemic heart disease deaths	SMR 0.84 (0.74–0.95)*
Occupational (n=9,027)		Cerebrovascular disease	SMR 0.81 (0.61–1.05)
		Ischemic heart disease risk	HR 0.89 (0.66–1.21), 4 th quartile risk
		Cerebrovascular disease risk	HR 0.98 (0.53–1.81), 4 th quartile risk
Sakr et al. 2009	NR	Ischemic heart disease risk	NS (p=0.16 for trend)
Occupational (n=4,747)			

2. HEALTH EFFECTS

Table 2-8. Summary of Cardiovascular Outcomes in Humans^a

Reference and study population ^b	Serum perfluoroalkyl level	Outcome evaluated	Result ^c
Steenland et al. 2015 Occupational (n=3,713)	Cumulative PFOA exposure	Coronary artery disease risk	NS (p=0.78 for trend), no lag NS (p=0.75 for trend), 10-year lag
		Hypertension	NS (p=0.95 for trend), no lag NS (p=0.54 for trend), 10-year lag
		Stroke	NS (p=0.35 for trend), no lag NS (p=0.64 for trend), 10-year lag
Steenland and Woskie 2012 Occupational (n=1,084)	7,800 ng/mL-years (mean cumulative PFOA exposure)	Ischemic heart disease deaths	SMR 0.93 (0.72–1.19), no lag
Anderson-Mahoney et al. 2008 Community (n=566)	NR	Cardiovascular disease (self-reported)	SPR 4.29 (3.47–5.29)*
		Angina (self-reported)	SPR 8.07 (6.54–9.95)*
		Myocardial infarction	SPR (1.91 (1.40–2.62))*
		Stroke	SPR 2.17 (1.47–3.21)*
		Hypertension	SPR 1.18 (0.97–1.43)
Darrow et al. 2013 Community (C8) (n=1,330)	6.9–<11.1 ng/mL (2 nd PFOA quintile)	Pregnancy-induced hypertension	OR 2.39 (1.05–5.46)* (2nd quintile)
Nolan et al. 2009 Community (C8) (n=1,555 women)	NR	Pregnancy-induced hypertension	
		LHWA residents Partial LHWA residents	OR 1.2 (0.7–2.0), unadjusted OR 0.8 (0.5–1.4), unadjusted
Savitz et al. 2012a Community (C8) (n=11,737 pregnant women)	6.8–<16.6 ng/mL (2 nd PFOA quartile, estimated)	Pre-eclampsia	OR 1.2 (1.0–1.5)*
Savitz et al. 2012b Community (C8) (n=224 cases of pregnancy-induced hypertension)	21.0–717.6 ng/mL (5 th PFOA quintile, estimated)	Pregnancy induced hypertension	OR 1.0 (0.7–1.3), 5 th quintile

2. HEALTH EFFECTS

Table 2-8. Summary of Cardiovascular Outcomes in Humans^a

Reference and study population ^b	Serum perfluoroalkyl level	Outcome evaluated	Result ^c
Savitz et al. 2012b Community (C8) (n=4,547 pregnant women)	21.0–717.6 ng/mL (5 th PFOA quintile, estimated)	Pregnancy induced hypertension	OR 1.1 (0.8–1.5)
Simpson et al. 2013 Community (C8) (n=28,541; 11% also had occupational exposure)	>178–319 ng/mL (cumulative, estimated 2 nd PFOA quintile)	Stroke	OR 1.39 (1.11–1.76)*, 2nd quintile
Stein et al. 2009 Community (C8) (n=5,262 pregnant women)	120.6–894.4 ng/mL (4 th PFOA quartile)	Pre-eclampsia	OR 0.9 (0.5–1.8)
Winquist and Steenland 2014a Community (C8) (n=28,541; 11% also had occupational exposure)	≥3,579 ng/mL (cumulative, estimated 5 th PFOA quintile)	Hypertension	HR 0.98 (0.91–1.06), 5 th quintile
		Coronary artery disease	HR 1.07 (0.93–1.23), 5 th quintile
Geiger et al. 2014a General population (NHANES) (n=1,655 adolescents)	>5.4 ng/mL (4 th quartile PFOA)	Hypertension	OR 0.69 (0.41–1.17), 4 th quartile
Lin et al. 2013a, 2013b General population (n=644)	3.49 ng/mL (median PFOA)	Carotid intima media thickness	NS (p=0.285 for trend)
Mattsson et al. 2015 General population (n=231 cases with CHD, 231 controls)	4.2 and 4.0 ng/mL (median PFOA in cases and controls)	Coronary artery disease	OR 0.88 (0.50–1.55), 4 th quartile
Melzer et al. 2010 General population (NHANES) (n=3,966 adults)	10.39 and 9.47 ng/mL (mean 4 th quartile PFOA)	Coronary artery disease, angina, and/or heart attack	OR 1.08 (0.70–1.69, p=0.715), 4 th quartile
Min et al. 2012 General population (NHANES) (n=2,208)	4.00 ng/mL (geometric mean PFOA)	Systolic blood pressure Hypertension risk	Association (p=0.0004)* OR 1.71 (1.23–2.36)*, 4th quartile

2. HEALTH EFFECTS

Table 2-8. Summary of Cardiovascular Outcomes in Humans^a

Reference and study population ^b	Serum perfluoroalkyl level	Outcome evaluated	Result ^c
Shankar et al. 2012	4.0–5.6 and 4.4–6.1 ng/mL (females and males, 3 rd PFOA quartile)	Cardiovascular disease	OR 1.77 (1.04–3.02)*, 3rd quartile
General population (NHANES) (n=1,216)	>5.6 and >6.1 ng/mL (females and males, 4 th PFOA quartile)	Peripheral arterial disease	OR 1.78 (1.03–3.08)*, 4th quartile
		Coronary heart disease	OR 2.24 (1.02–4.94)*, 4th quartile
		Stroke	OR 4.26 (1.84–9.89)*, 4th quartile
Starling et al. 2014b	2.78 ng/mL (median PFOA)	Pre-eclampsia	HR 0.89 (0.65–1.22), per ln unit
General population (n=976 pregnant women)			
PFOS			
Darrow et al. 2013	12.1–<15.9 ng/mL (3 rd PFOS quintile)	Pregnancy-induced hypertension	OR 2.71 (1.33–5.52)* (3rd quintile)
Community (C8) (n=1,330)			
Stein et al. 2009	23.2–83.4 ng/mL (4 th PFOS quartile)	Pre-eclampsia	OR 1.6 (1.2–2.3)*
Community (C8) (n=5,262 pregnant women)			
Geiger et al. 2014a	>25.5 ng/mL (4 th PFOS quartile)	Hypertension	OR 0.77 (0.37–1.61), 4 th quartile
General population (NHANES) (n=1,655 adolescents)			
Lin et al. 2013a, 2013b	8.65 ng/mL (median PFOS)	Carotid intima media thickness	Association (p<0.001 for trend)*
General population (n=644)			
Mattsson et al. 2015	22.8 and 22.0 ng/mL (median PFOS in cases and controls)	Coronary artery disease	OR 1.07 (0.60–1.92), 4 th quartile
General population (n=231 cases with CHD, 231 controls)			
Melzer et al. 2010	57.73 and 50.96 ng/mL (mean 4 th quartile PFOS)	Coronary artery disease, angina, and/or heart attack	OR 0.91 (0.570–1.64, p=0.745), 4 th quartile
General population (NHANES) (n=3,966 adults)			
Starling et al. 2014b	12.87 ng/mL (median PFOS)	Pre-eclampsia	HR 1.13 (0.84–1.52), per ln unit
General population (n=976 pregnant women)			

2. HEALTH EFFECTS

Table 2-8. Summary of Cardiovascular Outcomes in Humans^a

Reference and study population ^b	Serum perfluoroalkyl level	Outcome evaluated	Result ^c
PFHxS			
Mattsson et al. 2015 General population (n=231 cases with CHD, 231 controls)	1.6 ng/mL (median PFHxS in cases and controls)	Coronary artery disease	OR 0.95 (0.54–1.67), 4 th quartile
Starling et al. 2014b General population (n=976 pregnant women)	0.69 ng/mL (median PFHxS)	Pre-eclampsia	HR 0.91 (0.72–1.14), per ln unit
PFNA			
Lin et al. 2013a, 2013b General population (n=644)	0.38 ng/mL (median PFNA)	Carotid intima media thickness	Inverse association (p=0.014 for trend)*
Mattsson et al. 2015 General population (n=231 cases with CHD, 231 controls)	0.5 ng/mL (median PFNA in cases and controls)	Coronary artery disease	OR 0.68 (0.39–1.20), 4 th quartile
Starling et al. 2014b General population (n=976 pregnant women)	0.54 ng/mL (median PFNA)	Pre-eclampsia	HR 0.90 (0.70–1.16), per ln unit
PFDeA			
Mattsson et al. 2015 General population (n=231 cases with CHD, 231 controls)	0.2 ng/mL (median PFDeA in cases and controls)	Coronary artery disease	OR 0.92 (0.53–1.60), 4 th quartile
Starling et al. 2014b General population (n=976 pregnant women)	0.10 ng/mL (median PFDeA)	Pre-eclampsia	HR 0.88 (0.75–1.04), per ln unit
PFUA			
Lin et al. 2013a, 2013b General population (n=644)	6.59 ng/mL (median PFUA)	Carotid intima media thickness	NS (p=0.953 for trend)

2. HEALTH EFFECTS

Table 2-8. Summary of Cardiovascular Outcomes in Humans^a

Reference and study population ^b	Serum perfluoroalkyl level	Outcome evaluated	Result ^c
Mattsson et al. 2015 General population (n=231 cases with CHD, 231 controls)	0.2 ng/mL (median PFUA in cases and controls)	Coronary artery disease	OR 0.88 (0.51–1.51), 4 th quartile
Starling et al. 2014b General population (n=976 pregnant women)	0.17 ng/mL (median PFUA)	Pre-eclampsia	HR 0.78 (0.66–0.92)*, per ln unit
PFHpA			
Mattsson et al. 2015 General population (n=231 cases with CHD, 231 controls)	0.06 and 0.04 ng/mL (median PFHpA in cases and controls)	Coronary artery disease	OR 2.58 (1.39–4.78)*, 3rd quartile OR 1.73 (0.94–3.16), 4 th quartile
PFDoA			
Mattsson et al. 2015 General population (n=231 cases with CHD, 231 controls)	0.02 ng/mL (median PFDoA in cases and controls)	Coronary artery disease	OR 0.63 (0.35–1.11), 4 th quartile

^aSee the *Supporting Document for Epidemiological Studies for Perfluoroalkyls*, Table 3 for more detailed descriptions of studies.

^bParticipants in occupational exposure may have also lived near the site and received residential exposure; community exposure studies involved subjects living near PFOA facilities with known exposure to high levels of PFOA.

^cAsterisk indicates association with perfluoroalkyl compound; unless otherwise specified, values in parenthesis are 95% confidence intervals.

CHD = coronary heart disease; HR = hazard ratio; LHWA = Little Hocking Water Authority; NHANES = National Health and Nutrition Examination Survey; NR = not reported; NS = not significant; OR = odds ratio; PFDeA = perfluorodecanoic acid; PFDoA = perfluorododecanoic acid; PFHpA = perfluoroheptanoic acid; PFHxS = perfluorohexane sulfonic acid; PFNA = perfluorononanoic acid; PFOA = perfluorooctanoic acid; PFOS = perfluorooctane sulfonic acid; PFUA = perfluoroundecanoic acid; SMR = standardized mortality ratio; SPR = standard prevalence ratio

2. HEALTH EFFECTS

(controls) (Mattsson et al. 2015). Utilizing the NHANES data set, Shankar et al. (2012) found increases in the risk of peripheral arterial disease, coronary heart disease, or stroke in participants with serum PFOA levels in the 4th quartile (>5.6 and >6.1 ng/mL in females and males, respectively) and for cardiovascular disease in participants with serum PFOA levels in the 3rd and 4th quartiles (>4.0 and >4.4 ng/L for females and males, respectively). In contrast, another NHANES study did not find an association between serum PFOA and physician-diagnosed coronary artery disease, angina, and/or heart attack (Melzer et al. 2010). A general population study did not find an association between serum PFOA levels and carotid intima media thickness (Lin et al. 2013a).

Epidemiology Studies—Hypertension. Occupational, community, and general population exposure studies have investigated the possible association between PFOA and blood pressure, the risk of hypertension, and the risk of pregnancy-induced hypertension and/or pre-eclampsia. A study by Min et al. (2012) utilizing NHANES data found an increase in hypertension risk among participants with serum PFOA levels in the 4th quartile. In contrast, no increases in the risk of hypertension were observed in workers at the Washington Works facility (Steenland et al. 2015), adult community members living near this facility (Winquist and Steenland 2014a), or adolescent NHANES participants (Geiger et al. 2014a). There is some epidemiological evidence suggesting that an elevated uric acid level is a risk factor for hypertension (Johnson et al. 2003; Sündstrom et al. 2005). Several occupational, community, and general population studies have found increases in uric acid levels and increased risks of hyperuricemia; these data are discussed in Section 2.10. Overall, the results of these studies are suggestive of a connection between serum PFOA and increased risk of hyperuricemia.

Several studies have examined the possible associations between PFOA and pregnancy-induced hypertension/pre-eclampsia. Four studies have evaluated the community living near the Washington Works facility using different approaches to assess PFOA exposure. Savitz et al. (2012a, 2012b) used residential history and environmental dispersion of PFOA to estimate serum PFOA levels over time. Stein et al. (2009) used serum PFOA levels measured in 2005–2006 to assess the risk of pre-eclampsia occurring prior to the blood sampling. The fourth study (Darrow et al. 2013) primarily used serum PFOA levels measured in 2005–2006 to assess the association with pregnancy-induced hypertension occurring after the blood samples were collected. Savitz et al. (2012a) found an increased risk of self-reported pre-eclampsia in C8 Health Project participants with elevated PFOA levels. Another study of participants in the C8 Health Project that used measured serum perfluoroalkyl levels found significant increases in the odds ratios (ORs) for pregnancy-induced hypertension in women with higher PFOA (≥ 6.9 ng/mL) levels (Darrow et al. 2013). A third study of highly exposed residents reported a weak association between

2. HEALTH EFFECTS

serum PFOA and pre-eclampsia in subjects whose serum PFOA levels were above the median (Stein et al. 2009); however, there was no dose-response gradient. Using birth record data and serum PFOA levels predicted from addresses, Savitz et al. (2012b) found no consistent associations between serum PFOA and the occurrence of pregnancy-induced hypertension in participants in the C8 Health Project. Similarly, Stein et al. (2009) did not find increases in the odds of self-reported pre-eclampsia among C8 Health Project participants categorized by serum PFOA levels. Another study of residents of this area did not find increases in the risk of pregnancy-induced hypertension among residents living in an area where PFOA-contaminated water was supplied by the Little Hocking Water Authority (Nolan et al. 2010). A general population study did not find an association between plasma PFOA and the risk of pre-eclampsia (Starling et al. 2014a).

Laboratory Animal Studies. No histopathological alterations were seen in the heart from rats exposed intermittently head-only to up to 84 mg/m³ APFO dusts for 2 weeks (Kennedy et al. 1986). Administration of APFO in the diet at doses up to approximately 100–110 mg/kg/day to male and female CD rats or 10 mg/kg/day by gavage to Rhesus monkeys did not cause gross or microscopic alterations in the heart or aorta (Griffith and Long 1980). Similar negative findings were reported in Cynomolgus monkeys administered up to 20 mg/kg/day APFO by capsule for 26 weeks (Butenhoff et al. 2002) and in male and female Sprague-Dawley rats that received doses of up to 15 mg/kg/day APFO for 2 years (3M 1983). No morphological alterations were seen in the heart from male rats dermally exposed to ≤2,000 mg/kg APFO for 2 weeks (Kennedy 1985).

Summary. Cardiovascular toxicity as assessed by deaths from heart disease, risk of heart disease, and risk of hypertension has been evaluated in workers, community members living near a PFOA facility, and the general population. In general, occupational exposure studies have not found increases in the risks of deaths from heart disease or in the risks of ischemic heart disease, cerebrovascular disease, or coronary disease. Inconsistent results have been found in a small number of studies examining residents living in areas with high PFOA drinking water contamination or the general population. Studies of hypertension have also not found associations between serum PFOA and hypertension risk. However, studies of highly exposed residents provide some suggestive evidence of an association between serum PFOA and increased risks of pregnancy-induced hypertension/pre-eclampsia. Studies in laboratory animals did not find histological alterations in the heart following acute-, intermediate-, or chronic-duration oral exposure.

2. HEALTH EFFECTS

PFOS

Epidemiology Studies—Heart Disease. Three studies have evaluated the possible association between PFOS and heart disease. Melzer et al. (2010) did not find an association between serum PFOS and the risk of physician-diagnosed coronary artery disease, angina, and/or heart attack among NHANES participants. In a case-control study (Mattsson et al. 2015), no alterations in the risk of coronary artery disease were observed. Lin et al. (2013a) found an association between serum PFOS levels and carotid intima media thickness in a general population study.

Epidemiology Studies—Hypertension. No increases in the risk of hypertension associated with serum PFOS levels were observed in adolescent NHANES participants (Geiger et al. 2014a). Two studies found increases in the risk of pregnancy-induced hypertension (Darrow et al. 2013) or pre-eclampsia (Stein et al. 2009) associated with serum PFOS levels among C8 participants. No increase in the risk of pre-eclampsia was observed in a general population study (Starling et al. 2014b).

Laboratory Animal Studies. Administration of doses of up to 0.75 mg/kg/day PFOS (potassium salt) via capsule to Cynomolgus monkeys for 26 weeks did not cause any significant gross or microscopic alterations in the heart or aorta (Seacat et al. 2002). Rats that received up to approximately 1.04 mg/kg/day of PFOS in the diet for 2 years had no significant gross or microscopic changes in the heart (Butenhoff et al. 2012b; Thomford 2002b).

PFHxS

Epidemiology Studies. Two general population studies examined possible cardiovascular outcomes associated with PFHxS exposure. No increases in the risk of coronary artery disease (Mattsson et al. 2015) or pre-eclampsia (Starling et al. 2014b) were found.

Laboratory Animal Studies. Dosing of rats with ≤ 10 mg/kg/day PFHxS by gavage for 40–60 days did not cause morphological alterations in the heart (Butenhoff et al. 2009a; Hoberman and York 2003).

PFNA

Epidemiology Studies. In a general population study, an inverse association between serum PFNA levels and carotid intima media thickness was observed (Lin et al. 2013a). The investigators suggested that this

2. HEALTH EFFECTS

finding may be secondary to an interaction between higher serum PFOS levels and lower serum PFNA levels in the study population. Other general population studies have not found increases in the risk of coronary heart disease (Mattsson et al. 2015) or pre-eclampsia (Starling et al. 2014b) associated with increasing serum PFNA levels.

PFDeA

Epidemiology Studies. The risks of coronary artery disease (Mattsson et al. 2015) and pre-eclampsia (Starling et al. 2014b) were not associated with serum PFDeA levels in general population studies.

Laboratory Animal Studies. Death in female C57BL/6N mice following administration of a single lethal dose of 160 or 320 mg/kg PFDeA by gavage was associated with mural thrombosis of the left ventricle of the heart (Harris et al. 1989). Doses ≤ 80 mg/kg did not cause gross or microscopic alterations in the heart, assessed 30 days after dosing, but 80 mg/kg significantly decreased relative heart weight (Harris et al. 1989).

PFUA

Epidemiology Studies. Starling et al. (2014b) found an inverse association between serum PFUA levels and the risk of pre-eclampsia in pregnant women. No association between serum PFUA levels and carotid intima artery thickness was observed in a general population study (Lin et al. 2013a). A third general population study (Mattsson et al. 2015) did not find an increase in the risk of coronary artery disease associated with serum PFUA levels.

PFHpA

Epidemiology Studies. Mattsson et al. (2015) found an increase in the risk of coronary artery disease in individuals with serum PFHpA levels in the 3rd quartile; however, the risk was not increased for those with serum levels in the 4th quartile.

2. HEALTH EFFECTS

PFBuS

Laboratory Animal Studies. No morphological alterations were reported in the heart or aorta from rats dosed with ≤ 900 mg/kg/day PFBuS by gavage for 28 days (3M 2001) or ≤ 600 mg/kg/day PFBuS for 90 days (Lieder et al. 2009a).

PFBA

Laboratory Animal Studies. PFBA administered to rats by gavage in doses of up to 184 mg/kg/day for 5 days, 150 mg/kg/day for 28 days, or 30 mg/kg/day for 90 days did not induce gross or microscopic alterations in the heart (3M 2007a; Butenhoff et al. 2012a; van Otterdijk 2007a, 2007b).

PFD_oA

Epidemiology Studies. No increase in the risk of coronary heart disease associated with serum PFD_oA levels was found in a general population study (Mattsson et al. 2015).

2.6 GASTROINTESTINAL

Overview. Available epidemiology data on the potential of perfluoroalkyls to induce gastrointestinal effects are limited to two studies of workers at a PFOS facility that found mixed results on the possible association between PFOS and colon polyps; summaries of these studies are presented in the *Supporting Document for Epidemiological Studies for Perfluoroalkyls*, Table 4. Studies examining ulcerative colitis are discussed in Section 2.14, Immunological. Laboratory animal studies have examined the gastrointestinal tract for morphological alterations following inhalation, oral, or dermal exposure to PFOA (Tables 2-1, 2-3, and 2-6), oral exposure to PFOS (Table 2-4), and oral exposure to other perfluoroalkyls (Table 2-5); the NOAELs and LOAELs are presented in Figures 2-4, 2-6, and 2-7. Studies on PFOA and PFBuS have reported some signs of gastrointestinal irritation following gavage administration. Most studies did not report histological alterations in the gastrointestinal tract following exposure to PFOA, PFOS, PFHxS, or PFBA.

2. HEALTH EFFECTS

PFOA

Laboratory Animal Studies. Stomach irritation was reported in male rats exposed head-only to ≥ 380 mg/m³ APFO dusts for 4 hours (Kennedy et al. 1986). No histopathological alterations were seen in the stomach, small intestine, or large intestine from male rats exposed intermittently nose-only to up to 84 mg/m³ APFO dusts for 2 weeks (Kennedy et al. 1986).

No significant gross or microscopic alterations of the gastrointestinal tract were observed in male or female rats exposed to approximately 100–110 mg/kg/day APFO through the diet for 90 days (Griffith and Long 1980). Similar observations were reported in male and female rats exposed to 15 mg/kg/day APFO via the diet for 2 years (3M 1983). The same investigators also reported that emesis occurred in Rhesus monkeys exposed to lethal doses (30 and 100 mg/kg/day) of APFO by gavage for 90 days (Griffith and Long 1980). In another intermediate-duration study in which Cynomolgus monkeys were exposed to up to 20 mg/kg/day APFO administered via a capsule for 26 weeks, no treatment-related alterations in the gastrointestinal tract were observed at termination (Butenhoff et al. 2002).

Intermittent application of up to 2,000 mg/kg/day APFO to the skin of male rats for up to 2 weeks did not result in gross or microscopic alterations in the gastrointestinal tract (Kennedy 1985).

PFOS

Epidemiology Studies. There are limited data available on the potential of PFOS to induce gastrointestinal damage. A study of current, retired, or former workers employed for at least 1 year at a PFOS-based fluorochemical manufacturing facility in Decatur, Alabama found no association between self-reported incidence of gastric ulcer or colon polyps and having worked in a job with either low (estimated serum PFOS levels of 390–890 ng/mL) or high (estimated PFOS serum levels of 1,300–1,970 ng/mL) exposure to PFOS, as compared to workers with no direct workplace exposure (estimated serum PFOS levels of 110–290 ng/mL) (Grice et al. 2007). A second study of workers at the Decatur facility found an increase in the risk ratio episodes of care for benign colonic polyps in workers with high potential exposure to PFOS (Olsen et al. 2004a).

Laboratory Animal Studies. Unpublished data summarized by OECD (2002) indicate that distension of the small intestine was observed in rats exposed to lethal concentrations of airborne PFOS dusts (1,890–45,970 mg/m³) for 1 hour. Treatment of rats with up to approximately 1.04 mg/kg/day PFOS via the diet

2. HEALTH EFFECTS

for 2 years did not induce morphological alterations in the gastrointestinal tract (Butenhoff et al. 2012b; Thomford 2002b).

PFHxS

Laboratory Animal Studies. No morphological alterations were observed in the gastrointestinal tract of rats administered ≤ 10 mg/kg/day PFHxS via gavage for 42–56 days (Butenhoff et al. 2009a; Hoberman and York 2003).

PFBuS

Laboratory Animal Studies. Necrosis of individual squamous cells and hyperplasia and hyperkeratosis were observed in the limiting ridge of the forestomach of male and female rats administered 600 mg/kg/day PFBuS via gavage for 90 days (Lieder et al. 2009a); these lesions were likely due to irritation from the repeated gavage administration with PFBuS. In another study, no morphological alterations were observed in the gastrointestinal tract of rats administered ≤ 900 mg/kg/day PFBuS via gavage for 28 days (3M 2001).

PFBA

Laboratory Animal Studies. Administration of PFBA to rats by gavage in doses of up to 184 mg/kg/day for 5 days, 150 mg/kg/day for 28 days, or 30 mg/kg/day for 90 days did not cause morphological alterations in the gastrointestinal tract (3M 2007a; Butenhoff et al. 2012a; van Otterdijk 2007a, 2007b).

2.7 HEMATOLOGICAL

Overview. A small number of epidemiology studies have evaluated hematological endpoints in workers exposed to PFOA or PFOS and in a community exposure study; these studies did not find alterations in hematological indices. Details of these studies are presented in the *Supporting Document for Epidemiological Studies for Perfluoroalkyls*, Table 5. Laboratory animal studies have evaluated potential alterations in hematological endpoints for a variety of perfluoroalkyl compounds (Tables 2-1, 2-3, 2-4, 2-5, and 2-6). Some laboratory animal studies have reported alterations in hematological indices following exposure to higher doses of PFOA, PFOS, PFHxS, PFUA, PFBuS, PFBA, or PFHxA.

2. HEALTH EFFECTS

PFOA

Epidemiology Studies. Information on effects on hematological parameters is available from a study of residents in the Little Hocking water district in southeastern Ohio where there was significant environmental exposure to PFOA via the water supply (Emmett et al. 2006b). No significant correlations between any of the hematology parameters evaluated (including hemoglobin, hematocrit, red blood cell indices, white cell count, and platelet count) and serum PFOA were observed, whether the analysis included all of the individuals as a group or separate analyses were done for adults or children. In an occupational study, the investigators reported no alterations in blood counts in workers, with a range of serum PFOA levels of 5–9,550 ng/mL (Sakr et al. 2007b).

Laboratory Animal Studies. No treatment-related hematological alterations were reported in male rats exposed intermittently nose-only to up to 84 mg/m³ APFO dusts for 2 weeks (Kennedy et al. 1986). The specific parameters evaluated included erythrocyte counts, hemoglobin concentration, hematocrit, and differential leukocyte counts.

No significant hematological alterations were reported in male and female rats orally dosed with approximately 100–110 mg/kg/day APFO in diet for 90 days (Griffith and Long 1980). Similar results were reported in Cynomolgus monkeys treated daily with up to 20 mg/kg/day APFO administered via a capsule (Butenhoff et al. 2002; Thomford 2001) or in Rhesus monkeys dosed daily by gavage with up to 30 mg/kg/day (Griffith and Long 1980). In a 2-year dietary study in rats dosed with 1.5 or 15 mg/kg/day APFO, hematology tests performed at various times during the study showed changes in treated groups consisting of decreases in red blood cell counts, hemoglobin concentration, and hematocrit that were not always dose-related or consistent among sexes and were within acceptable ranges for the rat (3M 1983).

Hematology tests (erythrocyte count, hemoglobin concentration, hematocrit, total and differential leukocyte count, and red cell indices) conducted in blood from rats following intermittent dermal exposure to $\leq 2,000$ mg/kg/day APFO for 2 weeks showed inconsistent alterations or changes of unlikely biological significance (Kennedy 1985).

PFOS

Epidemiology Studies. Two occupational exposure studies (Olsen et al. 1998a, 2003a) have examined the potential association between serum PFOS and hematological parameters (including hematocrit,

2. HEALTH EFFECTS

hemoglobin, red blood cells, white blood cells, and platelets) in workers at 3M facilities in Decatur, Alabama and Antwerp, Belgium; mean measured levels of serum PFOS ranged from 800 to 2,440 ng/mL. No consistent alterations in hematological parameters were observed at either facility or at the different measuring time points.

Laboratory Animal Studies. Treatment of male and female rats with approximately 1.5–1.8 mg/kg/day PFOS (potassium salt) in the diet for 4 weeks did not result in significant alterations in hematological parameters (Seacat et al. 2003). Oral dosing with 1.3–1.6 mg/kg/day for 14 weeks resulted in a significant increase (45%) in non-segmented neutrophils (Seacat et al. 2003). The biological significance of this finding was not discussed by the investigators. In a 4-week study, oral administration of up to 2 mg/kg/day PFOS to Cynomolgus monkeys had no effect on hematological parameters (Thomford 2002a). In Cynomolgus monkeys dosed with 0, 0.03, 0.15, or 0.75 mg/kg/day PFOS (potassium salt) administered via a capsule for 26 weeks and subjected to comprehensive hematological tests during the study, the only significant effect was a 9% decrease in hemoglobin in 0.75 mg/kg/day males at termination (Seacat et al. 2002). The investigators considered this a treatment-related effect, but not biologically significant given that the value was within the published range and there was no evidence of blood in the stools. No significant hematological effects were reported in a 2-year study in rats dosed with approximately 1.04 mg/kg/day PFOS in the diet (Butenhoff et al. 2012b; Thomford 2002b).

PFHxS

Laboratory Animal Studies. Treatment of male rats with doses ≥ 0.3 mg/kg/day PFHxS by gavage for at least 42 days significantly increased prothrombin time (Butenhoff et al. 2009a; Hoberman and York 2003). Doses ≥ 1 mg/kg/day significantly decreased hemoglobin concentration, whereas ≥ 3 mg/kg/day decreased erythrocyte count and hematocrit; the decrease in hemoglobin (<5%) was not considered adverse at 1 mg/kg/day. Oral treatment of female rats with up to 10 mg/kg/day PFHxS did not significantly alter hematological parameters (Butenhoff et al. 2009a; Hoberman and York 2003).

PFUA

Laboratory Animal Studies. Treatment of rats with 1.0 mg/kg/day PFUA via gavage for 41–46 days resulted in significant hematological changes (Takahashi et al. 2014). Effects in males included decreased mean corpuscular volume (MCV) (5%), mean corpuscular hemoglobin (MCH) (5%), activated partial thromboplastin time (APTT) (16–25%), and fibrinogen (19–33%), and increased platelet counts

2. HEALTH EFFECTS

(13%) and white blood cells (7%). In females, there were increases in MCV (10%) and MCH (10%) and a decrease in fibrinogen (32%). The NOAEL was 0.3 mg/kg/day.

PFBuS

Laboratory Animal Studies. A 90-day exposure to PFBuS resulted in significant decreases in hemoglobin and hematocrit levels in males orally administered 200 or 600 mg/kg/day, and a decrease in erythrocyte levels was observed in males administered 600 mg/kg/day; the NOAEL was 60 mg/kg/day (Lieder et al. 2009a). In contrast, no hematological alterations were observed in rats administered 900 mg/kg/day PFBuS for 28 days (3M 2001).

PFBA

Laboratory Animal Studies. Administration of PFBA by gavage to rats in doses of up to 184 mg/kg/day for 5 days or up to 150 mg/kg/day for 28 days did not result in significant alterations in hematological parameters (3M 2007a; Butenhoff et al. 2012a; van Otterdijk 2007a). Oral doses of 30 mg/kg/day, but not 6 mg/kg/day, for 90 days resulted in significant reductions in red blood cell counts, hemoglobin, and hematocrit, and an increase in red cell distribution width in male rats (Butenhoff et al. 2012a; van Otterdijk 2007b). This dose level also caused a reduction in MCH and reduced MCH concentration in male rats. The lower hemoglobin and hematocrit observed in males were still detected at the end of a 3-week recovery period. These hematological effects were considered minor and not evidence of an adverse effect on red blood cell turnover by the investigator based on lack of alterations in bone marrow or the spleen.

PFHxA

Laboratory Animal Studies. In a 104-week gavage study, treatment of female Sprague-Dawley rats (60 or 70/dose) with 200 mg/kg/day PFHxA resulted in significant decreases in mean red blood cell counts (8.1%) and hemoglobin (5.2%), as well as significant increases in reticulocyte counts at weeks 25 and 51 (23.6 and 53.6%, respectively) (Klaunig et al. 2015). There were no alterations in hematological parameters in males. The NOAEL was 100 mg/kg/day.

2. HEALTH EFFECTS

2.8 MUSCULOSKELETAL

Overview. Several epidemiology studies have evaluated possible associations between perfluoroalkyls and bone mineral density, risk of bone fractures, and risk of osteoarthritis; the results of these studies are summarized in Table 2-9, with more detailed descriptions presented in the *Supporting Document for Epidemiological Studies for Perfluoroalkyls*, Table 6. Several cross-sectional community and general population studies have found associations between serum PFOA and the risk of osteoarthritis, particularly in participants under the age of 55 years. However, associations were not found in a study of mostly male workers. Mixed results were found in studies of PFOS, with studies finding a decreased risk of osteoarthritis, increased risk in women under 50 years of age, or no association. One general population study found increased risks of osteoarthritis associated with serum PFHxS and PFNA. The data provide some suggestive evidence of a relationship between serum perfluoroalkyls and osteoarthritis. Assessing whether there is a link between perfluoroalkyl exposure and osteoarthritis is complicated by the lack of mechanistic data to support this association and it is noted that there are a number of factors that contribute to the osteoarthritis risk, and that some of these factors may be affected by perfluoroalkyls, including elevations in uric acid levels. No morphological alterations were noted in bone or skeletal muscle in laboratory animals following exposure to PFOA, PFOS, PFBuS, or PFBA; these data are summarized in Tables 2-1, 2-3, 2-4, and 2-5 and Figures 2-4, 2-6, 2-7, and 2-8.

PFOA

Epidemiology Studies. Several studies have examined the possible association between serum PFOA levels and the risk of osteoarthritis; the possible mechanisms associated with these findings have not been elucidated. In an occupational study (80% male), no association between cumulative serum PFOA levels and the risk of osteoarthritis was found (Steenland et al. 2015). Innes et al. (2011) examined adult participants in the C8 Health Project and found that the odds of reporting osteoarthritis were higher in participants with serum PFOA levels in the 2nd, 3rd, and 4th quartiles compared to participants in the 1st quartile. When segregated by age and BMI, the strongest associations between serum PFOA levels and osteoarthritis were found in subjects under 55 years of age and in nonobese (BMI <30) subjects. Increases in the risk of osteoarthritis associated with serum PFOA levels were observed in female NHANES participants (Khalil et al. 2016; Uhl et al. 2013); there were no associations in men. When stratified by age, the associations were found in women 20–49 years of age, but not in older women (50–84 years old) (Uhl et al. 2013). Two studies of adult NHANES participants found no associations

2. HEALTH EFFECTS

Table 2-9. Summary of Skeletal Outcomes in Humans^a

Reference and study population ^b	Serum perfluoroalkyl level	Outcome evaluated	Result ^c
PFOA			
Steenland et al. 2015 Occupational (n=3,713 workers)	Cumulative exposure	Osteoarthritis risk	NS (p=0.92 for trend), no lag NS (p=0.13 for trend), 10-year lag
Innes et al. 2011 Community (C8) (n=49,432 adults)	13.6–28.0 ng/mL (2 nd PFOA quartile)	Osteoarthritis risk (physician diagnosed)	OR 1.16 (1.03–1.31)*, 2nd quartile OR 1.22 (1.02–1.45)*, 2nd quartile participants <55 years of age
Khalil et al. 2016 General population (NHANES) (n=1,914 participants)	3.7 ng/mL (mean PFOA)	Total femur neck mineral density Osteoarthritis risk (women)	β -0.017 (-0.033 to -0.001)*, women β 0.001 (-0.025–0.022), men OR 1.84 (1.17–2.90; p=0.008)*, per ln-PFOA increase
Lin et al. 2014 General population (NHANES) (n=2,339 participants)	4.70 and 3.31 ng/mL (geometric mean PFOA in males and females)	Total lumbar spine bone mineral density Total hip bone mineral density All fracture types Hip fracture Wrist fracture	NS (p>0.01), premenopausal women, postmenopausal women, men NS (p>0.01), premenopausal women, postmenopausal women, men OR 0.98 (0.75–1.28), premenopausal women OR 1.53 (0.63–3.74), postmenopausal women OR 0.84 (0.67–1.07), men OR 1.59 (0.57–4.46), premenopausal women OR 0.48 (0.06–4.16), postmenopausal women OR 0.64 (0.39–1.06), men OR 1.07 (0.65–1.77), premenopausal women OR 1.21 (0.46–3.13), postmenopausal women OR 1.12 (0.75–1.70), men

2. HEALTH EFFECTS

Table 2-9. Summary of Skeletal Outcomes in Humans^a

Reference and study population ^b	Serum perfluoroalkyl level	Outcome evaluated	Result ^c
		Spine fracture	OR 1.83 (0.59–5.61), premenopausal women OR 0.84 (0.46–1.53), postmenopausal women OR 1.54 (0.85–2.79), men
Uhl et al. 2013 General population (NHANES) (n=1,888 male and 1,921 female adults)	>5.89 ng/mL (4 th PFOA quartile)	Osteoarthritis risk (self-reported)	OR 1.98 (1.24–3.19)*, 4th quartiles females OR 0.82 (0.40–1.70), 4 th quartile males OR 4.95 (1.27–19.4)*, 4th quartile women 20–49 years of age OR 1.33 (0.82–1.16), 4 th quartile women 50–84 years of age
PFOS			
Innes et al. 2011 Community (C8) (n=49,432 adults)	≥29.4 ng/mL (4 th PFOS quartile)	Osteoarthritis risk (physician diagnosed)	OR 0.76 (0.68–0.85)*, 4th quartile
Khalil et al. 2016 General population (NHANES) (n=1,914 participants)	12.7 ng/mL (mean PFOS)	Total femur neck mineral density Osteoarthritis risk (women)	β -0.016 (-0.029 to -0.002)*, women β -0.013 (-0.024 to -0.002)*, men OR 1.14 (0.68–1.94; p=0.619), per ln-PFOS increase
Lin et al. 2014 General population (NHANES) (n=2,339 participants)	19.23 and 12.09 ng/mL (geometric mean PFOS in males and females)	Total lumbar spine bone mineral density Total hip bone mineral density All fracture types	β -0.022 (-0.038 to -0.007)*, premenopausal women NS (p>0.01), postmenopausal women NS (p>0.01), men NS (p>0.01), premenopausal women, postmenopausal women, men OR 0.97 (0.75–1.24), premenopausal women OR 1.59 (0.88–2.86), postmenopausal women OR 0.92 (0.73–1.16), men

2. HEALTH EFFECTS

Table 2-9. Summary of Skeletal Outcomes in Humans^a

Reference and study population ^b	Serum perfluoroalkyl level	Outcome evaluated	Result ^c
		Hip fracture	OR 1.12 (0.62–2.03), premenopausal women OR 0.83 (0.23–3.00), postmenopausal women OR 1.07 (0.76–1.52), men
		Wrist fracture	OR 1.04 (0.63–1.72), premenopausal women OR 1.22 (0.61–2.45), postmenopausal women OR 1.09 (0.72–1.66), men
		Spine fracture	OR 0.52 (0.15–1.86), premenopausal women OR 1.12 (0.26–4.78), postmenopausal women OR 1.27 (0.67–2.42), men
PFHxS			
Khalil et al. 2016	2.5 ng/mL (mean PFHxS)	Total femur bone mineral density	β -0.014 (-0.074 to -0.014)*, women β -0.026 (-0.065–0.013), men
General population (NHANES) (n=1,914 participants)		Osteoarthritis risk (women)	OR 1.64 (1.14–2.38; p=0.008)*, per ln-PFHxS increase
PFNA			
Khalil et al. 2016	1.9 ng/mL (mean PFNA)	Total femur bone mineral density	β -0.040 (-0.077 to -0.003)*, women β 0.007 (-0.031–0.045), men
General population (NHANES) (n=1,914 participants)		Osteoarthritis risk (women)	OR 1.45 (1.02–2.05; p=0.001)*, per ln-PFNA increase.

^aSee the *Supporting Document for Epidemiological Studies for Perfluoroalkyls*, Table 6 for more detailed descriptions of studies.

^bParticipants in occupational exposure may have also lived near the site and received residential exposure; community exposure studies involved subjects living near PFOA facilities with known exposure to high levels of PFOA.

^cAsterisk indicates association with perfluoroalkyl compound; unless otherwise specified, values in parenthesis are 95% confidence intervals.

NHANES = National Health and Nutrition Examination Survey; NS = not significant; OR = odds ratio; PFHxS = perfluorohexane sulfonic acid; PFNA = perfluorononanoic acid; PFOA = perfluorooctanoic acid; PFOS = perfluorooctane sulfonic acid

2. HEALTH EFFECTS

between serum PFOA and bone mineral density of the total femur (Khalil et al. 2016), hip (Lin et al. 2014), or lumbar spine (Khalil et al. 2016; Lin et al. 2014); however, an inverse association was found in the neck portion of the femur in the Khalil et al. (2016) study. Additionally, Lin et al. (2014) did not find associations between serum PFOA levels and the risk of bone fractures (total fractures, hip fractures, wrist fractures, or spine fractures) in premenopausal women, postmenopausal women, or men.

Laboratory Animal Studies. In male rats exposed head-only to up to 84 mg/m³ APFO dusts for up to 2 weeks, examinations of the sternbrae were unremarkable (Kennedy et al. 1986). Similarly, no gross or microscopic alterations were reported in the sternum from rats following dietary exposure to 100–110 mg/kg/day APFO for 90 days (Griffith and Long 1980) or in the femur, sternum, or thigh skeletal muscle from Cynomolgus monkeys dosed with up to 20 mg/kg/day APFO administered via a capsule for 26 weeks (Butenhoff et al. 2002). *In utero* exposure to PFOA resulted in morphometrical alterations in the femur (increases in the periosteal area) and decreases in bone mineral density in the tibia of 13- or 17-month-old mice (Koskela et al. 2016). No alterations in biomechanical properties were found. The investigators noted that PFOA concentrations were 4–5 times higher in the PFOA-exposed animals than in controls.

PFOS

Epidemiology Studies. Several epidemiology studies have evaluated the potential of PFOS to induce skeletal damage. In the participants of the C8 Health Study, a decreased risk of osteoarthritis was found in participants with serum PFOS levels in the 2nd, 3rd, and 4th quartiles (Innes et al. 2011). In contrast, Uhl et al. (2013) found an increased risk of osteoarthritis in NHANES participants with serum levels of >20.97 ng/mL. When categorized by sex and age, the osteoarthritis risk was approximately 5 times higher in women aged 20–49 years with serum PFOS levels in the 4th quartile. Another study of NHANES participants (Khalil et al. 2016) did not find an increased risk of osteoarthritis in women. However, the study did find an inverse association between serum PFOS and femur neck bone mineral density, but no associations with total femur or lumbar spine bone mineral density.

Laboratory Animal Studies. Treatment of monkeys with up to 0.75 mg/kg/day PFOS (potassium salt) administered via a capsule for 26 weeks had no significant effect on the gross or microscopic appearance of the femur, sternum, or thigh skeletal muscle (Seacat et al. 2002). Similar observations were made in rats treated with up to 1.04 mg/kg/day PFOS in the diet for 2 years (Butenhoff et al. 2012b; Thomford 2002b).

2. HEALTH EFFECTS

PFHxS

Epidemiology Studies. A study of NHANES participants found an increase in the risk of osteoarthritis among women that was associated with serum PFHxS levels (Khalil et al. 2016). An inverse association between serum PFHxS (fourth quartile) and total femur bone mineral density was also found in women. There were no associations between serum PFHxS and femur neck or lumbar spine bone mineral density (Khalil et al. 2016).

PFNA

Epidemiology Studies. Khalil et al. (2016) found an increase in the risk of osteoarthritis in women NHANES participants that was associated with serum PFNA levels. Increasing serum PFNA levels did not result in alterations in bone mineral density of the lumbar spine or femur neck, but was inversely associated with total femur bone mineral density in women with serum PFNA levels in the fourth quartile.

PFBuS

Laboratory Animal Studies. Treatment of rats with up to 900 mg/kg/day PFBuS by gavage for 28 or 90 days did not induce morphological alterations in skeletal muscle (3M 2001; Lieder et al. 2009a).

PFBA

Laboratory Animal Studies. PFBA administered to rats by gavage in doses of up to 184 mg/kg/day for 5 days did not induce morphological alterations in skeletal muscle (3M 2007a). Administration of 150 mg/kg/day PFBA for 28 days or 30 mg/kg/day for 90 days did not induce gross or microscopic alterations in bone (femur and sternum) or skeletal muscle (Butenhoff et al. 2012a; van Otterdijk 2007a, 2007b).

2.9 HEPATIC

Overview. Epidemiology studies on perfluoroalkyls have examined three potential hepatic outcomes: liver disease, alterations in serum enzyme and bilirubin levels, and alterations in serum lipid levels. Summaries of the epidemiology studies examining these outcomes are presented in Tables 2-10, 2-11, and

2. HEALTH EFFECTS

2-12, with more detailed descriptions presented in the *Supporting Document for Epidemiological Studies for Perfluoroalkyls*, Table 7. There are limited epidemiology data on potential associations between serum perfluoroalkyls and risk of liver disease. Occupational exposure and community studies did not find increased risk of liver disease associated with PFOA or PFOS. As assessed by serum enzyme and bilirubin levels, the epidemiology studies provide suggestive evidence of liver damage. Increases in aspartate aminotransferase (AST), alanine aminotransferase (ALT), and gamma-glutamyl transferase (GGT) levels and decreases in serum bilirubin levels have been reported in occupational, community, and/or general population studies. Although there is considerable variability across studies, the evidence is adequate for PFOA, PFOS, and PFHxS, particularly for ALT levels; consistent results were not found for PFNA. The results of available epidemiology studies suggest associations between increases in serum lipids, particularly total cholesterol and LDL cholesterol, and serum PFOA, PFOS, PFNA, and PFDeA. For PFHxS, PFUA, PFHpA, PFBuS, PFBA, and PFDoA, there are too few studies or the results are too inconsistent to determine if they also would affect serum lipid levels at environmental exposure levels.

Numerous animal studies have evaluated the hepatotoxicity of perfluoroalkyls following inhalation, oral, and dermal exposure; summaries of these studies are presented in Tables 2-1, 2-2, 2-3, 2-4, 2-5, and 2-6 and the NOAEL and LOAEL values are graphically presented in Figures 2-4, 2-5, 2-6, 2-7, and 2-8. The results of these studies provide strong evidence that the liver is a sensitive target of PFOA, PFOS, PFHxS, PFNA, PFUA, PFBuS, and PFBA toxicity. Observed effects in rodents include increases in liver weight; hepatocellular hypertrophy, hyperplasia, and necrosis; and decreases in serum cholesterol and triglyceride levels. As discussed in greater detail in Section 2.20, these effects are believed to be initiated by PPAR α ; however, studies in PPAR α -null mice suggest that other mechanisms are also involved. Increases in liver weight have also been observed in monkey studies for PFOA and PFOS; these studies have also found alterations in serum lipid levels and hepatocellular hypertrophy (PFOS only).

To address concern over the relevance of liver enlargement in rodents to human health risk, the European Society of Toxicologic Pathology (ESTP) convened an expert panel to define what constitutes an adverse hepatic effect and whether hepatic effects induced by nuclear hormone receptors such as PPAR α , constitutive androstane receptor (CAR), or pregnane X receptor (PXR) are rodent-specific adaptive reactions; the findings of the panel are summarized by Hall et al. (2012). As discussed by Hall et al. (2012), criteria were established for determining whether increases in liver organ weight and liver cell hypertrophy observed in studies of rodents exposed to agents inducing enzyme induction can be considered adaptive responses and of little relevance to humans. According to the ESTP criteria,

2. HEALTH EFFECTS

Table 2-10. Summary of Liver Disease in Humans^a

Reference and study population ^b	Serum perfluoroalkyl level	Outcome evaluated	Result ^c
PFOA			
Anderson-Mahoney et al. 2008	NR	Liver problems (self-reported)	SPR 1.01 (0.64–1.59)
Community (n=566)			
Darrow et al. 2016	Cumulative 16.5 ng/mL (median 2005/2006)	Liver disease	HR 0.97 (0.92–1.03), no lag per ln increase in PFOA HR 0.98 (0.93–1.04), 10-year lag
Community (C8) (n=28,831)		Enlarged liver, fatty liver, or cirrhosis	HR 0.97 (0.91–1.04), no lag per ln increase in PFOA HR 1.00 (0.94–1.07), 10-year lag
Steenland et al. 2015	Cumulative	Non-hepatitis liver disease risk	NS (p=0.86), no lag NS (p=0.40), 10-year lag
Occupational (n=3,713)			
PFOS			
Alexander et al. 2003	NR	Liver cirrhosis deaths	SMR 0.81 (0.10–2.94)
Occupational (n=2,083)			
Grice et al. 2007	1,300–1,970 ng/mL (high potential workers)	Liver disease	OR 1.21 (0.56–2.60)
Occupational (n=1,400)		Cholelithiasis	OR 0.91 (0.57–1.46)
		Cholecystitis	OR 1.15 (0.65–2.06)

2. HEALTH EFFECTS

Table 2-10. Summary of Liver Disease in Humans^a

Reference and study population ^b	Serum perfluoroalkyl level	Outcome evaluated	Result ^c
Olsen et al. 2004a Occupational (n=652 exposed, n=659 for non-exposed)	NR	Cholelithiasis or acute cholecystitis	RRE_pC 8.6 (1.1->100)* RRE_pC 25 (2.1->100)*, workers with ≥10 years high exposure potential
		Liver disease	RRE _p C 1.2 (0.2–8.6)
		Biliary duct disorders	RRE _p C 1.6 (0.8–2.9) RRE_pC 2.6 (1.2–5.5)*, workers with ≥10 years high exposure potential

^aSee the *Supporting Document for Epidemiological Studies for Perfluoroalkyls*, Table 7 for more detailed descriptions of studies.

^bParticipants in occupational exposure may have also lived near the site and received residential exposure; community exposure studies involved subjects living near PFOA facilities with known exposure to high levels of PFOA.

^cAsterisk indicates association with perfluoroalkyl compound; unless otherwise specified, values in parenthesis are 95% confidence intervals.

HR = hazard ratio; NR = not reported; NS = not significant; OR = odds ratio; PFOA = perfluorooctanoic acid; PFOS = perfluorooctane sulfonic acid; RRE_pC = risk ratio episode of care; SMR = standardized mortality ratio; SPR = standard prevalence ratio

2. HEALTH EFFECTS

Table 2-11. Summary of Alterations in Serum Hepatic Enzymes and Bilirubin Levels in Humans^a

Reference and study population ^b	Serum perfluoroalkyl level	Outcome evaluated	Result ^c
PFOA			
Costa et al. 2009 Occupational (n=37 current workers; n=16 former workers; n=107 non-exposed workers)	12,930 ng/mL (mean PFOA current workers) 6,810 ng/mL (mean former workers)	AST	NS (p>0.05) (34 current workers)
		ALT	NS (p>0.05) (34 current workers) Association (p<0.01)* (56 current, former, non-exposed workers)
		GGT	NS (p>0.05) (34 current workers) Association (p<0.01)* (56 current, former, non-exposed workers)
		Total bilirubin	Inverse association (p<0.01)* (56 current, former, non-exposed workers)
Gilliland and Mandel 1996 Occupational (n=115)	NR (serum fluorine levels used as surrogate for serum PFOA)	ALT	NS (p=0.32)
		AST	NS (p=0.80)
		GGT	NS (p=0.81)
Olsen et al. 2000 Occupational (n=111, 80, and 74 in 1993, 1995, and 1997)	5,000, 6,400, and 6,400 ng/mL (mean PFOA in 1993, 1995, and 1997) Workers divided into three groups: 0–<1,000, 1,000–<10,000, and ≥10,000 ng/mL	ALT	NS (p=0.82, 0.30, 0.73) differences between exposure groups for each measurement period
		AST	NS (p=0.33, 0.45, 0.83) differences between exposure groups for each measurement period
		GGT	NS (p=0.24, 0.41, 0.78) differences between exposure groups for each measurement period
		Total bilirubin	NS (p=0.48, 0.11, 0.58) differences between exposure groups for each measurement period
		Direct bilirubin	NS (p=0.82, 0.05, 0.74) differences between exposure groups for each measurement period

2. HEALTH EFFECTS

Table 2-11. Summary of Alterations in Serum Hepatic Enzymes and Bilirubin Levels in Humans^a

Reference and study population ^b	Serum perfluoroalkyl level	Outcome evaluated	Result ^c
Olsen and Zobel 2007 Occupational (n=552)	2170 ng/mL (mean 8 th PFOA decile) 12,150 ng/mL (mean 10 th PFOA decile)	GGT	Association (p=0.05)* OR 1.0 (0.3–2.9), 10 th decile
		Elevated GGT	
		Total bilirubin	Inverse association (p=0.001)*
		ALT	NS (p=0.06)
		Elevated ALT	OR 1.2 (0.5–3.4), 10 th decile
		AST	NS (p=0.55)
Sakr et al. 2007a Occupational (n=454)	1,130 ng/mL (mean PFOA)	Total bilirubin	Association (p=0.006)*
		AST	Association (p=0.009)*
		ALT	NS (p>0.05)
		GGT	NS (p>0.05)
Sakr et al. 2007b Occupational (n=1,025)	428 ng/mL (mean PFOA)	GGT	Association (p=0.016)*
		AST	NS (p=0.317)
		ALT	NS (p=0.124)
		Bilirubin	NS (p=0.590)
Wang et al. 2012 Occupational (n=55)	2,157.74 ng/mL (mean PFOA)	AST	Association (p=0.02)*
		ALT	NS (p=0.38)
Darrow et al. 2016 Community (C8) (n=28,831)	Cumulative 16.5 ng/mL (median PFOA in 2005/2006)	ALT	Association (p<0.0001 for trend)*, cumulative levels Association (p<0.0001 for trend)*, 2005/2006 levels
		GGT	NS (p=0.1021), cumulative levels NS (p=0.1552), 2005/2006 levels
		Bilirubin	Inverse association (p=0.0029 for trend)*, cumulative levels Inverse association (p=0.0036 for trend)*, 2005/2006 levels

2. HEALTH EFFECTS

Table 2-11. Summary of Alterations in Serum Hepatic Enzymes and Bilirubin Levels in Humans^a

Reference and study population ^b	Serum perfluoroalkyl level	Outcome evaluated	Result ^c
Emmett et al. 2006b Community (n=371)	354 ng/mL (median PFOA)	ALT	NS (p>0.05)
		Abnormal ALT	NS (p>0.05)
		AST	NS (p>0.05)
		Abnormal AST	Inverse association (p=0.03)*
Gallo et al. 2012 Community (C8) (n=46,452)	NR	ALT	Correlation (p<0.001)*
		Abnormal ALT	OR 1.19 (1.03–1.37)*, 3rd decile
		GGT	Correlation (p<0.001)*
		Abnormal GGT	NS (p=0.213 for trend)
Wang et al. 2012 Community (n=132)	378.30 ng/mL (mean PFOA)	Direct bilirubin	NS (p>0.05)
		Abnormal bilirubin	NS (p=0.496 for trend)
		ALT	NS (p=0.05)
		AST	NS (p=0.22)
Gleason et al. 2015 General population (NHANES) (n=4,333)	3.7 ng/mL (median PFOA)	ALT	Association (p<0.001)*
		Elevated ALT	Association (p=0.007 for trend)*
		AST	Association (p<0.01)*
		Elevated AST	NS (p=0.058 for trend).
		GGT	Association (p<0.01)*
		Elevated GGT	Association (p=0.042 for trend)*
		Total bilirubin	Association (p<0.01)*
		Elevated bilirubin	Association (p<0.001 for trend)*
Lin et al. 2010 General population (NHANES) (n=2,216)	5.05 and 4.06 ng/mL (geometric mean PFOA in males and females)	ALT	Association (p=0.005)*
		GGT	Association (p=0.019)*
		Total bilirubin	NS (p=0.645)
Yamaguchi et al. 2013 General population (n=608)	2.1 ng/mL (mean PFOA)	ALT	Association (p=0.02)*
		AST	Association (p=0.001)*
		GGT	Association (p=0.03)*

2. HEALTH EFFECTS

Table 2-11. Summary of Alterations in Serum Hepatic Enzymes and Bilirubin Levels in Humans^a

Reference and study population ^b	Serum perfluoroalkyl level	Outcome evaluated	Result ^c
PFOS			
Grice et al. 2007 Occupational (n=1,400)	1,300–1,970 ng/mL (high potential workers)	Cholelithiasis	OR 0.91 (0.57–1.46)
		Cholecystitis	OR 1.15 (0.65–2.06)
Olsen et al. 1999 Occupational (n=178 in 1995; n=149 in 1997)	2,440 and 1,930 ng/mL (mean PFOS in 1995 in DeCatur and Antwerp) 1,960 and 1,480 ng/mL (mean PFOS in 1997 in DeCatur and Antwerp)	AST	NS (p=0.14 for trend), 1995 NS (p=0.67 for trend), 1997
		ALT	NS (p=0.38 for trend), 1995 NS (p=0.46 for trend), 1997
		GGT	NS (p=0.71 for trend), 1995 NS (p=0.34 for trend), 1997
Olsen et al. 2003a Occupational (n=518)	2460 ng/mL (median 4 th PFOS quartile)	AST	NS (p>0.05), no adjustments
		ALT	Higher levels (p<0.05)*, males only with no adjustments
		Risk of abnormal ALT	OR 2.1 (0.6–7.3)
		GGT	Difference (p<0.05)*, females only with no adjustments
Gallo et al. 2012 Community (C8) (n=46,452)	NR	Risk of abnormal GGT	OR 2.0 (0.7–5.8)
		ALT	Correlation (p<0.001)*
		Abnormal ALT	OR 1.19 (1.04–1.37)*, 5th decile
		GGT	NS (p>0.05)
		Abnormal GGT	Association (p=0.047 for trend)*
		Direct bilirubin	Correlation (p<0.001)*
		Abnormal bilirubin	Association (p=0.015 for trend)*

2. HEALTH EFFECTS

Table 2-11. Summary of Alterations in Serum Hepatic Enzymes and Bilirubin Levels in Humans^a

Reference and study population ^b	Serum perfluoroalkyl level	Outcome evaluated	Result ^c
Gleason et al. 2015 General population (NHANES) (n=4,333)	11.3 ng/mL (median PFOS)	ALT	NS (p>0.01)
		Elevated ALT	NS (p=0.370 for trend)
		AST	NS (p>0.01)
		Elevated AST	NS (p=0.438 for trend)
		GGT	NS (p>0.01)
		Elevated GGT	NS (p=0.654 for trend)
		Total bilirubin	NS (p>0.01)
		Elevated bilirubin	Association (p=0.028 for trend)*
Lin et al. 2010 General population (NHANES) (n=2,216)	27.39 and 22.20 ng/mL (geometric mean PFOS in males and females)	ALT	NS (p=0.066)
		GGT	NS (p=0.808)
		Total bilirubin	NS (p=0.223)
Yamaguchi et al. 2013 General population (n=608)	5.8 ng/mL (mean PFOS)	ALT	Association (p=0.03)*
		AST	Association (p=0.01)*
		GGT	Association (p=0.03)*
PFHxS			
Gleason et al. 2015 General population (NHANES) (n=4,333)	1.8 ng/mL (median PFHxS)	ALT	Association (p<0.01)*
		Elevated ALT	NS (p=0.484 for trend)
		AST	Association (p<0.001)*
		Elevated AST	NS (p=0.230 for trend)
		GGT	NS (p>0.01)
		Elevated GGT	NS (p=0.415 for trend)
		Total bilirubin	Association (p<0.01)*
		Elevated bilirubin	Association (p=0.041 for trend)*
Lin et al. 2010 General population (NHANES) (n=2,216)	2.29 and 1.72 ng/mL (geometric mean PFHxS in males and females)	ALT	NS (p=0.691)
		GGT	NS (p=0.898)
		Total bilirubin	NS (p=0.063)

2. HEALTH EFFECTS

Table 2-11. Summary of Alterations in Serum Hepatic Enzymes and Bilirubin Levels in Humans^a

Reference and study population ^b	Serum perfluoroalkyl level	Outcome evaluated	Result ^c
PFNA			
Mundt et al. 2007 Occupational (n=592)	NR	ALT	NS, longitudinal analysis
		AST	NS, longitudinal analysis
		GGT	NS, longitudinal analysis
		Bilirubin	NS, longitudinal analysis
Gleason et al. 2015 General population (NHANES) (n=4,333)	1.4 ng/mL (median PFNA)	ALT	Association (p<0.001)*
		Elevated ALT	NS (p=0.042 for trend)
		AST	NS (p>0.01)
		Elevated AST	NS (p=0.516 for trend)
		GGT	Association (p<0.01)*
		Elevated GGT	NS (p=0.126 for trend)
		Total bilirubin	NS (p>0.01)
Elevated bilirubin	NS (p=0.614 for trend)		
Lin et al. 2010 General population (NHANES) (n=2,216)	0.89 and 0.72 ng/mL (geometric mean PFNA in males and females)	ALT	NS (p=0.131)
		GGT	NS (p=0.857)
		Total bilirubin	NS (p=0.053)

^aSee the *Supporting Document for Epidemiological Studies for Perfluoroalkyls*, Table 7 for more detailed descriptions of studies.

^bParticipants in occupational exposure may have also lived near the site and received residential exposure; community exposure studies involved subjects living near PFOA facilities with known exposure to high levels of PFOA.

^cAsterisk indicates association with perfluoroalkyl compound; unless otherwise specified, values in parenthesis are 95% confidence intervals.

ALT = alanine aminotransferase; AST = aspartate aminotransferase; GGT = gamma-glutamyl transferase; OR = odds ratio; NHANES = National Health and Nutrition Examination Survey; NR = not reported; NS = not significant; PFHxS = perfluorohexane sulfonic acid; PFNA = perfluorononanoic acid; PFOA = perfluorooctanoic acid; PFOS = perfluorooctane sulfonic acid

2. HEALTH EFFECTS

Table 2-12. Summary of Serum Lipid Outcomes in Humans^a

Reference and study population ^b	Serum perfluoroalkyl level	Outcome evaluated	Result ^c
PFOA			
Costa 2004 Occupational (n=35)	NR	Total cholesterol	Association (p=0.03)*
		Non-HDL cholesterol	Association (p=0.03)*
		HDL cholesterol	NS (p>0.05)
		LDL cholesterol	NS (p>0.05)
		Total triglycerides	NS (p>0.05)
Costa et al. 2009 Occupational (n=37 current workers; n=16 former workers; n=107 non-exposed workers)	12,930 ng/mL (mean PFOA in current workers) 6,810 ng/mL (mean PFOA in former workers)	Total cholesterol	Association (p=0.005)* (current workers) Association (p<0.05)* (56 current, former, non-exposed workers)
		HDL cholesterol	NS (p>0.05) (34 current workers)
		Triglycerides	NS (p>0.05)
Gilliland and Mandel 1996 Occupational (n=115)	NR (serum fluorine levels used as surrogate for serum PFOA)	Total cholesterol	NS (p=0.62)
		Total LDL	NS (p=0.87)
		Total HDL	NS (p=0.66)
Olsen et al. 2000 Occupational (n=111, 80, and 74 in 1993, 1995, and 1997)	5,000, 6,400, and 6,400 ng/mL (mean PFOA in 1993, 1995, and 1997) Workers divided into three groups: 0-<1,000, 1,000-<10,000, and ≥10,000 ng/mL	Total cholesterol	NS (p=0.45, 0.48, 0.08) differences between exposure groups for each measurement period
		LDL cholesterol	NS (p=0.84, 0.96, 0.11) differences between exposure groups for each measurement period
		HDL cholesterol	NS (p=0.32, 0.70, 0.40) differences between exposure groups for each measurement period
		Triglycerides	NS (p=0.77, 0.07, 0.13) differences between exposure groups for each measurement period

2. HEALTH EFFECTS

Table 2-12. Summary of Serum Lipid Outcomes in Humans^a

Reference and study population ^b	Serum perfluoroalkyl level	Outcome evaluated	Result ^c
Olsen and Zobel 2007 Occupational (n=552)	2,170 ng/mL (mean of 8 th PFOA decile) 12,150 ng/mL (mean of 10 th PFOA decile)	Total cholesterol	NS (p=0.20)
		Elevated total cholesterol	OR 1.1 (0.5–2.6), 10 th decile
		LDL cholesterol	NS (p=0.81)
		Elevated LDL- cholesterol	OR 1.2 (0.5–2.8), 10 th decile
		HDL cholesterol	Association (p=0.01)*
		Decreased HDL cholesterol	OR 1.8 (0.7–4.8), 10 th decile
		Triglycerides	Association (p=0.0001)*
		Elevated triglycerides	OR 1.8 (0.8–4.4), 10 th decile
Sakr et al. 2007a Occupational (n=454)	1,130 ng/mL (mean PFOA)	Total cholesterol	Association (p=0.011)*
		LDL cholesterol	NS (p>0.05)
		HDL cholesterol	NS (p>0.05)
		Triglycerides	NS (p>0.05)
		Total bilirubin	Association (p=0.006)*
Sakr et al. 2007b Occupational (n=1,025)	428 ng/mL (mean PFOA)	Total cholesterol	Association (p=0.002)*
		LDL cholesterol	Association (p=0.008)*
		VLDL cholesterol	Association (p=0.031)*
		HDL cholesterol	NS (p=0.680)
		Triglycerides	NS (p=0.384)
Steenland et al. 2015 Occupational (n=3,713)	Cumulative PFOA	Elevated cholesterol	NS (p=0.56), no lag NS (p=0.62), 10-year lag
Wang et al. 2012 Occupational (n=55)	2,157.74 ng/mL (mean PFOA)	Total cholesterol	NS (p=0.36)
		LDL cholesterol	NS (p=0.43)
		HDL cholesterol	Inverse association (p=0.01)*
		Triglycerides	NS (p=0.37)
Emmett et al. 2006b Community (n=371)	354 ng/mL (median PFOA)	Total cholesterol	NS (p>0.05)
		Abnormal cholesterol	NS (p>0.05)

2. HEALTH EFFECTS

Table 2-12. Summary of Serum Lipid Outcomes in Humans^a

Reference and study population ^b	Serum perfluoroalkyl level	Outcome evaluated	Result ^c
Fitz-Simon et al. 2013 Community (C8) (n=560 adults)	140.1 and 68.2 ng/mL (mean PFOA at first and second examinations)	Total cholesterol	-1.65% (-0.32 to -2.97)*, 50% decrease in PFOA
		LDL cholesterol	-3.58% (-1.47 to -5.66)*, 50% decrease in PFOA
		HDL cholesterol	-1.33% (0.21 to -2.85), 50% decrease in PFOA
		Triglycerides	0.78% (5.34 to -3.58), 50% decrease in PFOA
Frisbee et al. 2010 Community (C8) (n=12,476 children and adolescents)	77.7 ng/mL (mean PFOA in children) 61.8 ng/mL (mean PFOA in adolescents)	Total cholesterol	Association (p<0.001)*, children 5th quintile Association (p<0.001)*, adolescents 5th quintile
		Abnormal cholesterol	OR 1.1 (1.0–1.3), 2 nd quintile
		LDL cholesterol	Association (p=0.001)*, children 5th quintile Association (p=0.004)*, adolescents 5th quintile
		Abnormal LDL levels	OR 1.2 (1.0–1.5), 2 nd quintile
		HDL cholesterol	NS (p=0.88), children 5 th quintile NS (p=0.20), adolescents 5 th quintile
		Triglycerides	NS (p=0.1), children 5 th quintile NS (p=0.1), adolescents 5 th quintile
		Steenland et al. 2009b Community (C8) (n=46,294)	80.3 ng/mL (mean PFOA) 13.2–26.5 ng/mL (2 nd PFOA quartile)
Abnormal cholesterol	OR 1.21 (1.12–1.31)*, 2nd quartile		
LDL cholesterol	Association (p<0.05 for trend)*		
HDL cholesterol	NS (p>0.05)		
Triglycerides	Association (p<0.05 for trend)*		

2. HEALTH EFFECTS

Table 2-12. Summary of Serum Lipid Outcomes in Humans^a

Reference and study population ^b	Serum perfluoroalkyl level	Outcome evaluated	Result ^c
Wang et al. 2012 Community (n=132)	378.30 ng/mL (mean PFOA)	Total cholesterol	NS (p=0.85)
		LDL cholesterol	NS (p=0.97)
		Triglycerides	NS (p=0.73)
		HDL cholesterol	NS (p=0.39)
Winquist and Steenland 2014a Community (C8) (n=28,541)	142–<234 ng/mL (estimated 2 nd quintile for cumulative PFOA)	Hypercholesterolemia	HR 1.24 (1.15–1.33)*, 2nd quintile for cumulative exposure
Eriksen et al. 2013 General population (n=753)	7.1 ng/mL (mean PFOA)	Total cholesterol	Association (p=0.01)*
Fisher et al. 2013 General population (n=2,368)	2.46 ng/mL (mean PFOA)	Total cholesterol	NS (p=0.22)
		High cholesterol levels	OR 1.5 (0.86–2.62), 4 th quartile
		Non HDL cholesterol	NS (p=0.13)
		LDL cholesterol	NS (p=0.63)
		HDL cholesterol	NS (p=0.96)
Fu et al. 2014a General population (n=133)	1.43 ng/mL (median PFOA)	Total cholesterol	Association (p=0.015)*
		Elevated cholesterol	OR 0.55 (0.09–3.31)
		LDL cholesterol	Association (p=0.022)*
		Elevated LDL	OR 0.71 (0.14–3.49)
		HDL cholesterol	NS (p=0.260)
		Elevated HDL	OR 0.67 (0.13–3.51)
		Triglycerides	NS (p=0.298)
		Elevated triglyceride	OR 1.97 (0.59–6.55)

2. HEALTH EFFECTS

Table 2-12. Summary of Serum Lipid Outcomes in Humans^a

Reference and study population ^b	Serum perfluoroalkyl level	Outcome evaluated	Result ^c
Geiger et al. 2014b General population (NHANES) (n=815 12–18-year-old adolescents)	4.2 ng/mL (mean PFOA)	Total cholesterol	Association (p=0.0170 for trend)*
		Elevated cholesterol	OR 1.44 (1.11–1.88, p=0.0253 for trend)*, log transformed PFOA
		LDL cholesterol	Association (p=0.0027 for trend)*
		Elevated LDL	NS (p=0.0539 for trend)
		HDL cholesterol	NS (p=0.1769 for trend)
		Decreased HDL	NS (p=0.1493 for trend)
		Triglycerides	NS (p=0.9943 for trend)
		Elevated triglycerides	NS (p=0.5975 for trend)
Maisonet et al. 2015a General population (n=111 for 7-year-old and n=88 for 15-year-old girls)	1.1–3.1, 3.2–4.4, and 4.5–16.4 ng/mL (maternal PFOA for 1 st , 2 nd , and 3 rd tertiles)	Total cholesterol in 7 year olds	Association (β 13.75, 0.05–27.45)*, 1st tertile NS, 2 nd and 3 rd tertiles
		Total cholesterol in 15 year olds	Association (β 17.19, 0.405–33.93)*, 1st tertile NS, 2 nd and 3 rd tertiles
		LDL cholesterol in 7 year olds	Association (β 14.01, 3.26–24.76)*, 1st tertile NS, 2 nd and 3 rd tertiles
		LDL cholesterol in 15 year olds	Association (β 14.261, 0.25–28.26)*, 1st tertile NS, 2 nd and 3 rd tertiles
		HDL cholesterol	NS (β -0.40, -1.82–1.01), 3 rd tertile 7 year olds NS (β -0.520, -2.10–1.06), 3 rd tertile 15 year olds
		Triglycerides	NS (β -0.020, -0.068–0.029), 3 rd tertile, 7 year olds NS (β -0.013, -0.051–0.025), 3 rd tertile, 15 year olds

2. HEALTH EFFECTS

Table 2-12. Summary of Serum Lipid Outcomes in Humans^a

Reference and study population ^b	Serum perfluoroalkyl level	Outcome evaluated	Result ^c
Nelson et al. 2010 General population (NHANES) (n=860)	4.6 ng/mL (mean PFOA)	Total cholesterol	NS (p=0.07)
		LDL cholesterol	NS (p=0.84)
		Non-HDL cholesterol	Association (p=0.05)* β 1.38 (0.12–2.65), per ng/mL increase in PFOA
		HDL cholesterol	NS (p=0.34)
Skuladottir et al. 2015 General population (n=854 pregnant women)	4.1 ng/mL (mean PFOA)	Total cholesterol	Association (p=0.01 for trend)*
Starling et al. 2014a General population (n=854 pregnant women)	2.25 ng/mL (50 th PFOA percentile)	Total cholesterol	NS (β 2.58; -4.32–9.47), per In-unit increase in PFOA
		LDL cholesterol	NS (β 0.35 -3.97–8.48), per In-unit increase in PFOA
		HDL cholesterol	Association (β 3.42 0.56–6.28)*, 4th quartile
		Triglycerides	NS (β 0.00 (-0.07–0.06), per In-unit increase in PFOA
Timmermann et al. 2014 General population (n=499 children, 8–10 years old)	9.3 ng/mL (median PFOA)	Triglycerides	NS (p=0.91), normal weight children Association (p=0.002)*, obese children
Zeng et al. 2015 General population (n=225 adolescents, 12– 15 years old)	1.1 and 0.92 ng/mL (mean PFOA in boys and girls)	Total cholesterol	Association (p=0.001)*
		LDL cholesterol	Association (p=0.002)*
		HDL cholesterol	NS (p=0.06)
		Triglycerides	Association (p<0.001)*

2. HEALTH EFFECTS

Table 2-12. Summary of Serum Lipid Outcomes in Humans^a

Reference and study population ^b	Serum perfluoroalkyl level	Outcome evaluated	Result ^c
PFOS			
Olsen et al. 1999 Occupational (n=178 in 1995; n=149 in 1997)	2,440 and 1,930 ng/mL (mean PFOS in 1995 in DeCatur and Antwerp) 1,960 and 1,480 ng/mL (mean in 1997 in DeCatur and Antwerp)	Total cholesterol	NS (p=0.96 for trend), 1995 Association (p=0.006 for trend)*, 1997
		LDL cholesterol	NS (p=0.87 for trend), 1995 Association (p=0.01 for trend)*, 1997
		HDL cholesterol	Inverse association (p=0.04 for trend)*, 1995 NS (p=0.34) 1997
		Triglycerides	NS (p=0.35 for trend), 1995 NS (p=0.67 for trend), 1997
Olsen et al. 2003a Occupational (n=518)	2,460 ng/mL (median 4 th PFOS quartile)	Total cholesterol	NS (p>0.05), no adjustments Association (p=0.04)*, with adjustments
		HDL cholesterol	NS (p>0.05), no adjustments
		Triglycerides	Higher levels (p<0.05)*, males only with no adjustments Association (p=0.01)*, with adjustments
Frisbee et al. 2010 Community (C8) (n=12,476 children and adolescents)	23.6 ng/mL (mean PFOS in children) 21.9 ng/mL (mean PFOS in adolescents)	Total cholesterol	Association (p<0.001)*, children 5th quintile Association (p<0.001)*, adolescents 5th quintile
		Abnormal cholesterol	OR 1.3 (1.1–1.4)*, 2nd quintile
		LDL cholesterol	Association (p=0.002)*, children 5th quintile Association (p<0.001)*, adolescents 5th quintile
		Abnormal LDL levels	OR 1.2 (1.0–1.5)*, 2nd quintile

2. HEALTH EFFECTS

Table 2-12. Summary of Serum Lipid Outcomes in Humans^a

Reference and study population ^b	Serum perfluoroalkyl level	Outcome evaluated	Result ^c
		HDL cholesterol	Association (p=0.007)*, children 5th quintile Association (p=0.001)*, adolescents 5th quintile
		Triglycerides	NS (p=0.1), children 5 th quintile NS (p=0.1), adolescents 5 th quintile
Steenland et al. 2009b	22.4 ng/mL (mean PFOS) 13.3–19.5 ng/mL (2 nd quartile)	Total cholesterol	Association (p<0.001 for trend)*
Community (C8) (n=46,294)		Abnormal cholesterol	OR 1.14 (1.05–1.23)*, 2nd quartile
		LDL cholesterol	Association (p<0.05 for trend)*
		HDL cholesterol	NS (p>0.05)
		Triglycerides	Association (p<0.05 for trend)*
Châtaeu-Degat et al. 2010	25.7 ng/mL (mean PFOS)	Total cholesterol	NS (p=0.086)
General population (n=723)		LDL cholesterol	NS (p=0.242)
		HDL cholesterol	Association (p<0.001)*, men Association (p=0.001)*, women
		Triglycerides	NS (p=0.162), men Inverse association (p=0.040)*, women
Eriksen et al. 2013	36.1 ng/mL (mean PFOS)	Total cholesterol	Association (p=0.02)*
General population (n=753)			
Fisher et al. 2013	8.04 ng/mL (mean PFOS)	Total cholesterol	NS (p=0.35)
General population (n=2,368)		High cholesterol levels	OR 1.36 (0.87–2.12), 4 th quartile
		Non HDL cholesterol	NS (p=0.14)
		LDL cholesterol	NS (p=0.42)
		HDL cholesterol	NS (p=0.33)

2. HEALTH EFFECTS

Table 2-12. Summary of Serum Lipid Outcomes in Humans^a

Reference and study population ^b	Serum perfluoroalkyl level	Outcome evaluated	Result ^c
Fu et al. 2014a General population (n=133)	1.47 ng/mL (median PFOS)	Total cholesterol	NS (p=0.287)
		Elevated cholesterol	OR 2.27 (0.47–10.92)
		LDL cholesterol	NS (p=0.357)
		Elevated LDL	OR 2.27 (0.50–10.37)
		HDL cholesterol	NS (p=0.260)
		Elevated HDL	OR 0.29 (0.06–1.50)
		Triglycerides	NS (p=0.711)
		Elevated triglyceride	OR 1.26 (0.41–3.90)
Geiger et al. 2014b General population (NHANES) (n=815 12–18-year-old adolescents)	17.7 ng/mL (mean PFOS)	Total cholesterol	NS (p=0.0512 for trend)
		Elevated cholesterol	OR 1.35 (1.11–1.64, p=0.0183 for trend)*, log transformed PFOS
		LDL cholesterol	Association (p=0.0081 for trend)*
		Elevated LDL	OR 1.48 (1.15–1.90, p=0.0178 for trend)*, log transformed PFOS
		HDL cholesterol	NS (p=0.9703)
		Decreased HDL	NS (p=0.9873 for trend)
		Triglycerides	NS (p=0.1104 for trend)
		Elevated triglycerides	NS (p=0.2418 for trend)
Maisonet et al. 2015b General population (n=111 for 7-year-old and n=88 for 15-year-old girls)	23.5–94.5 ng/mL (3 rd tertile maternal PFOS)	Total cholesterol	NS (β -0.10, -0.73–0.54), 7 year olds Association (β -0.77, -1.40 to -0.13)*, 15 year olds
		LDL cholesterol	NS (β 0.02, -0.48–0.53), 7 year olds Association (β -0.54, -1.08 to -0.003)*, 15 year olds
		HDL cholesterol	NS (β -0.04, -0.33–0.25), 7 year olds NS (β -0.18, -0.47–0.12), 15 year olds
		Triglycerides	NS (β -0.004, -0.015–0.006), 7 year olds
			NS (β -0.004, -0.011–0.004), 15 year olds

2. HEALTH EFFECTS

Table 2-12. Summary of Serum Lipid Outcomes in Humans^a

Reference and study population ^b	Serum perfluoroalkyl level	Outcome evaluated	Result ^c
Nelson et al. 2010 General population (NHANES) (n=860)	25.3 ng/mL (mean PFOS)	Total cholesterol	Association (p=0.01)*
		LDL cholesterol	NS (p=0.27)
		Non-HDL cholesterol	Association (p=0.02)*
		HDL cholesterol	NS (p=0.78)
Skuladottir et al. 2015 General population (n=854 pregnant women)	22.3 ng/mL (mean PFOS)	Total cholesterol	Association (p=0.01 for trend)*
Starling et al. 2014a General population (n=854 pregnant women)	13.03 ng/mL (50 th PFOS percentile)	Total cholesterol	Association (p<0.05)*
		LDL cholesterol	NS (β 6.48, -0.07–13.03), per In-unit increase in PFOS
		HDL cholesterol	Association (β 4.39, 2.37–6.42)*, per In-unit increase in PFOS
		Triglycerides	NS (β -0.02, -0.09–0.04), per In-unit increase in PFOS
Timmermann et al. 2014 General population (n=499 children, 8–10 years old)	41.5 ng/mL (median PFOS)	Triglycerides	NS (p=0.78), normal weight children Association (p=0.002)*, obese children
Zeng et al. 2015 General population (n=225 children, 12–15 years old)	32.4 and 34.2 ng/mL (mean PFOS in boys and girls)	Total cholesterol	Association (p<0.001)*
		LDL cholesterol	Association (p<0.001)*
		HDL cholesterol	NS (p=0.72)
		Triglycerides	Association (p=0.05)*
PFHxS			
Fisher et al. 2013 General population (n=2,368)	2.18 ng/mL (mean PFHxS)	Total cholesterol	Association (p=0.005)*
		High cholesterol levels	OR 1.27 (1.11–1.45)*, 4th quartile
		Non HDL cholesterol	Association (p=0.002)*
		LDL cholesterol	Association (p=0.02)*
		HDL cholesterol	NS (p=0.67)

2. HEALTH EFFECTS

Table 2-12. Summary of Serum Lipid Outcomes in Humans^a

Reference and study population ^b	Serum perfluoroalkyl level	Outcome evaluated	Result ^c
Nelson et al. 2010 General population (NHANES) (n=860)	2.6 ng/mL (mean PFHxS)	Total cholesterol	NS (p=0.07)
		LDL cholesterol	NS (p=0.10)
		Non-HDL cholesterol	Association (p=0.04)*
		HDL cholesterol	NS (p=0.11)
Starling et al. 2014a General population (n=854 pregnant women)	0.60 ng/mL (50 th PFHxS percentile)	Total cholesterol	NS (β 3.00, -1.75–7.76), per ln-unit increase in PFHxS
		LDL cholesterol	NS (β 1.92, -2.50–6.33), per ln-unit increase in PFHxS
		HDL cholesterol	Association (β 1.46; 0.19–2.73)*, per ln-unit increase in PFHxS
		Triglycerides	NS (β -0.01, -0.05–0.03), per ln-unit increase in PFHxS
Zeng et al. 2015 General population (n=225 children, 12–15 years old)	2.1 and 2.1 ng/mL (mean PFHxS in boys and girls)	Total cholesterol	NS (p=0.23)
		LDL cholesterol	NS (p=0.17)
		HDL cholesterol	NS (p=0.54)
		Triglycerides	NS (p=0.15)
PFNA			
Mundt et al. 2007 Occupational (n=592)	NR	Total cholesterol	NS, longitudinal analysis
		Triglycerides	NS, longitudinal analysis
Fu et al. 2014a General population (n=133)	0.37 ng/mL (median PFNA)	Total cholesterol	Association (p=0.002)*
		Elevated cholesterol	OR 1.03 (0.24–4.46)
		LDL cholesterol	Association (p=0.004)
		Elevated LDL	OR 2.51 (0.59–10.74)
		HDL cholesterol	NS (p=0.191)
		Lowered HDL	OR 1.06 (0.20–5.57)
		Triglycerides	NS (p=0.460)
Elevated triglycerides	OR 0.80 (0.26–2.49)		

2. HEALTH EFFECTS

Table 2-12. Summary of Serum Lipid Outcomes in Humans^a

Reference and study population ^b	Serum perfluoroalkyl level	Outcome evaluated	Result ^c
Nelson et al. 2010 General population (NHANES) (n=860)	1.3 ng/mL (mean PFNA)	Total cholesterol	Association (p=0.04)*
		LDL cholesterol	NS (p=0.08)
		Non-HDL cholesterol	Association (p=0.04)*
		HDL cholesterol	NS (p=0.31)
Starling et al. 2014a General population (n=854 pregnant women)	0.39 ng/mL (50 th PFNA percentile)	Total cholesterol	NS (β 0.01, -5.98–6.00), per In-unit increase in PFNA
		LDL cholesterol	NS (β -2.15, -7.31–3.02), per In-unit increase in PFNA
		HDL cholesterol	Association (β 2.84; 0.97–4.71)*, per In-unit increase in PFNA
		Triglycerides	NS (β -0.02, -0.07–0.03), per In-unit increase in PFNA
Zeng et al. 2015 General population (n=225 children, 12–15 years old)	0.8 and 0.9 ng/mL (mean PFNA in boys and girls)	Total cholesterol	Association (p=0.04)*
		LDL cholesterol	Association (p=0.05)*
		HDL cholesterol	NS (p=0.37)
		Triglycerides	Association (p=0.007)*
PFDaA			
Fu et al. 2014a General population (n=133)	0.19 ng/mL (median PFDaA)	Total cholesterol	Association (p=0.048)*
		Elevated cholesterol	OR 3.84 (0.87–16.95)
		LDL cholesterol	NS (p=0.251)
		Elevated LDL	OR 2.17 (0.52–9.04)
		HDL cholesterol	Association (p=0.007)*
		Elevated HDL	OR 2.21 (0.49–10.07)
		Triglycerides	NS (p=0.317)
Elevated triglycerides	OR 0.51 (0.17–1.58)		

2. HEALTH EFFECTS

Table 2-12. Summary of Serum Lipid Outcomes in Humans^a

Reference and study population ^b	Serum perfluoroalkyl level	Outcome evaluated	Result ^c
Starling et al. 2014a General population (n=854 pregnant women)	0.09 ng/mL (50 th PFDeA percentile)	Total cholesterol	NS (β 1.84, -2.12–5.79), per ln-unit increase in PFDeA
		LDL cholesterol	NS (β 0.19, -3.30–3.69), per ln-unit increase in PFDeA
		HDL cholesterol	Association (β 2.54, 1.22–3.87)*, per ln-unit increase in PFDeA
		Triglycerides	NS (β -0.03, -0.07–0.01), per ln-unit increase in PFDeA
Zeng et al. 2015 General population (n=225 children, 12–15 years old)	1.0 and 1.0 ng/mL (mean PFDeA in boys and girls)	Total cholesterol	NS (p=0.74)
		LDL cholesterol	NS (p=0.85)
		HDL cholesterol	NS (p=0.47)
		Triglycerides	NS (p=0.92)
PFUA			
Fu et al. 2014a General population (n=133)	0.26 ng/mL (median PFUA)	Total cholesterol	NS (p=0.184)
		Elevated cholesterol	OR 3.70 (0.76–18.03)
		LDL cholesterol	NS (p=0.270)
		Elevated LDL	OR 4.16 (0.96–18.00)
		HDL cholesterol	NS (p=0.279)
		Elevated HDL	OR 0.54 (0.11–2.57)
		Triglycerides	NS (p=0.755)
		Elevated triglycerides	OR 0.74 (0.25–2.21)
Starling et al. 2014a General population (n=854 pregnant women)	0.22 ng/mL (50 th PFUA percentile)	Total cholesterol	NS (β 0.89, -3.28–5.06), per ln-unit increase in PFUA
		LDL cholesterol	NS (β -2.36, -5.97–1.25), per ln-unit increase in PFUA
		HDL cholesterol	Association (β 4.05, 2.75–5.35)*, per ln-unit increase in PFUA
		Triglycerides	NS (β -0.04, -0.08–0.00), per ln-unit increase in PFUA

2. HEALTH EFFECTS

Table 2-12. Summary of Serum Lipid Outcomes in Humans^a

Reference and study population ^b	Serum perfluoroalkyl level	Outcome evaluated	Result ^c
PFHpA			
Fu et al. 2014a	0.04 ng/mL (median PFHpA)	Total cholesterol	NS (p>0.05)
General population (n=133)		LDL cholesterol	NS (p>0.05)
		HDL cholesterol	NS (p>0.05)
		Triglycerides	NS (p>0.05)
PFBuS			
Zeng et al. 2015	0.5 and 0.4 ng/mL (mean PFBuS in boys and girls)	Total cholesterol	Association (p=0.04)*
General population (n=225 children, 12–15 years old)		LDL cholesterol	NS (p=0.14)
		HDL cholesterol	NS (p=0.15)
		Triglycerides	NS (p=0.81)
PFBA			
Fu et al. 2014a	0.11 ng/mL (median PFBA)	Total cholesterol	NS (p>0.05)
General population (n=133)		LDL cholesterol	NS (p>0.05)
		HDL cholesterol	NS (p>0.05)
		Triglycerides	NS (p>0.05)
PFDoA			
Zeng et al. 2015	4.5 and 4.4 ng/mL (mean PFDoA in boys and girls)	Total cholesterol	NS (p=0.37)
General population (n=225 children, 12–15 years old)		LDL cholesterol	NS (p=0.44)
		HDL cholesterol	NS (p=0.68)
		Triglycerides	NS (p=0.40)

^aSee the *Supporting Document for Epidemiological Studies for Perfluoroalkyls*, Table 7 for more detailed descriptions of studies.

^bParticipants in occupational exposure may have also lived near the site and received residential exposure; community exposure studies involved subjects living near PFOA facilities with known exposure to high levels of PFOA.

^cAsterisk indicates association with perfluoroalkyl compound; unless otherwise specified, values in parenthesis are 95% confidence intervals.

HDL = high density lipoprotein; LDL = low density lipoprotein; NHANES = National Health and Nutrition Examination Survey; NR = not reported; NS = not significant; OR = odds ratio; PFBA = perfluorobutyric acid; PFBuS = perfluorobutane sulfonic acid; PFDeA = perfluorodecanoic acid; PFDoA = perfluorododecanoic acid; PFHpA = perfluoroheptanoic acid; PFHxS = perfluorohexane sulfonic acid; PFNA = perfluorononanoic acid; PFOA = perfluorooctanoic acid; PFOS = perfluorooctane sulfonic acid; PFUA = perfluoroundecanoic acid; VLDL = very low-density lipoprotein

2. HEALTH EFFECTS

increases in liver weight without histological evidence, such as (1) degenerative or necrotic changes including hepatocyte necrosis, inflammation, and steatotic vascular degeneration; (2) biliary/oval cell proliferation, degeneration, fibrosis, and cholestasis; or (3) necrosis and degeneration of other resident cells within the liver, are not considered adverse or relevant for human risk assessment. In the absence of histological changes, increases in liver organ weight are not considered relevant for human risk assessment unless at least two of the following three parameters are present: (1) at least 2–3 times increase in ALT levels; (2) biologically significant change in other biomarkers of hepatobiliary damage (alkaline phosphatase, AST, GGT, etc.); or (3) biologically significant change in another clinical pathology marker indicating liver dysfunction (albumin, bilirubin, bile acids, coagulation factors, cholesterol, triglycerides, etc.). ATSDR has adapted the criteria from Hall et al. (2012) for determining the adversity of the liver effects reported in the rodent perfluoroalkyl studies. Doses associated with increases in liver weight and hepatocellular hypertrophy were not considered adverse effect levels unless hepatocellular degenerative or necrotic changes or evidence of biliary or other liver cell damage were also present. The lowest doses associated with the liver weight increases and hepatocellular hypertrophy are noted in the LSE tables even though the dose levels are considered NOAELs.

PFOA

Epidemiology Studies—Liver Disease. Three studies of highly exposed populations have examined possible associations between PFOA and increased risk of liver disease. In workers, no association between estimated cumulative serum PFOA levels and the risk of non-hepatitis liver disease was observed (Steenland et al. 2015). Similarly, two studies of residents living near the Washington Works PFOA facility reported no increases in liver disease. In a study by Anderson-Mahoney et al. (2008), no significant increases in self-reported liver problems were found in residents primarily served by the Lubeck Public Water Service District or Little Hocking Water District; the study did not measure serum PFOA levels. In a C8 Health Project study that included workers at the Washington Works facility, estimated cumulative serum PFOA levels were not associated with any liver disease or enlarged liver, fatty liver, or cirrhosis (Darrow et al. 2016).

Epidemiology Studies—Hepatic Serum Enzymes and Bilirubin Levels. The possible association between PFOA exposure and hepatic enzymes has been examined in seven occupational exposure studies that have found inconsistent results. A small study of Italian perfluoroalkyl workers did not find associations between serum PFOA and ALT, AST, or GGT activities when only current workers were examined (Costa et al. 2009). In analysis of all workers (current, former, and non-exposed workers),

2. HEALTH EFFECTS

associations between serum PFOA levels and ALT and GGT activities were found; total bilirubin was also inversely associated with serum PFOA. Another small study of workers at a fluorochemical facility in China found an association between serum PFOA and AST activity, but not ALT activity (Wang et al. 2012). Gilliland and Mandel (1996) did not find associations between serum fluorine levels (used as a surrogate for serum PFOA) and ALT, AST, or GGT levels in workers. In a follow-up study of this facility, there were no differences between AST, ALT, GGT, or total bilirubin levels between workers in three exposure groups (Olsen et al. 2000); the mean serum PFOA levels in this study ranged from 5,000 to 6,400 ng/mL at three time points and the serum PFOA levels in the lowest exposure group ranged from 0 to <1,000 ng/mL. Increases in GGT and decreases in total bilirubin levels associated with increases in serum PFOA were observed in a study of workers exposed to high levels of PFOA and PFOS (Olsen and Zobel 2007); ALT activity was not affected. In a cross-sectional study of active workers at a PFOA facility, a modest but statistically significant positive association between serum PFOA and GGT activity was found (Sakr et al. 2007b). No associations were found for bilirubin levels or ALT and AST activities.

The possible associations between serum PFOA and serum enzyme and bilirubin levels were examined in two longitudinal occupational exposure studies. Sakr et al. (2007a) examined the relationship between serum PFOA and liver enzymes in a longitudinal study of 454 workers who had two or more measurements of serum PFOA from 1979 until the study was conducted. The average length of employment among workers with multiple PFOA measurements was 11 years, and, on average, 10.8 years elapsed between their first and last serum PFOA measurement. The means of the first and last PFOA measurement were 1,040 and 1,160 ng/mL, respectively. After adjustment for potential confounders, serum PFOA was associated with AST activity, but not ALT, GGT, or total bilirubin. The second study included 179 workers involved in the demolition of 3M perfluoroalkyl manufacturing facilities examined over a mean period of 164 days (Olsen et al. 2012). In workers with prior exposure to PFOA who had a decrease in serum PFOA levels during the study period, there was a significant increase in ALT levels. An increase in serum PFOA levels did not significantly alter AST or total bilirubin levels.

Community and general population exposure studies have also examined possible associations between serum PFOA levels and alterations in serum hepatic enzyme and bilirubin levels. As with the occupational exposure studies, several studies of populations living near PFOA facilities have found inconsistent results. Darrow et al. (2016) found associations between ALT and bilirubin (inverse association) and cumulative and 2005/2006 serum PFOA levels in participants of the C8 Health Project (6.5% of the participants also worked at the facility); there were no associations with GGT activity. Gallo

2. HEALTH EFFECTS

et al. (2012) also reported a significant correlation between serum PFOA levels and ALT activity in C8 Health Project participants. Unlike the Darrow et al. (2016) study, a significant correlation between serum PFOA levels and GGT activity, but no correlation with direct bilirubin levels, was found. An earlier study of residents in the same area, as well as a study of residents near a facility in China, did not find associations between serum PFOA and ALT, AST, or GGT (Emmett et al. 2006b; Wang et al. 2012).

More consistent results were found in three general population studies. In studies utilizing data from NHANES, Gleason et al. (2015) and Lin et al. (2010) reported associations between serum PFOA levels and ALT, AST, and GGT activities; total bilirubin was also found to be associated with serum PFOA in the Gleason et al. (2015) study, but not in the Lin et al. (2010) study. A general population study conducted in Japan (Yamaguchi et al. 2013) also found associations between serum PFOA levels and AST, ALT, and GGT activities.

Although a number of epidemiology studies have found associations between serum PFOA and serum hepatic enzyme and bilirubin levels, many of the investigators noted that liver biomarker levels were typically within the normal range. Four studies examining the risk of having biomarker levels outside of the normal range provide useful information for evaluating the health impact of the enzyme level alterations. For ALT, Gallo et al. (2012) and Gleason et al. (2015) found increased risks of abnormal levels in C8 and NHANES participants, respectively. In contrast, Olsen and Zobel (2007) and Emmett et al. (2006b) did not find increased risks of abnormal ALT levels in workers and C8 participants, respectively. No alterations in the risk of abnormal AST levels associated with elevated serum PFOA levels were observed in NHANES participants (Gleason et al. 2015). Emmett et al. (2006b) found a decrease in the risk of abnormal AST levels with increasing serum PFOA levels in community members. Associations between the risk of elevated GGT and serum PFOA were found in the study conducted by Gleason et al. (2015), but not in the Olsen and Zobel (2007), Gallo et al. (2012), or Emmett et al. (2006b) studies. Similarly, Gleason et al. (2015) reported an association between serum PFOA and the risk of elevated bilirubin levels, whereas Gallo et al. (2012) did not find this association in the higher exposed population.

Epidemiology Studies—Serum Lipids. Occupational, community, and general population studies have examined the possible associations between serum PFOA levels and serum lipid levels; the results of these studies are presented in Table 2-12. Summaries of the changes in serum total cholesterol and LDL cholesterol levels, as well as the risk associated with elevated serum cholesterol and LDL cholesterol levels, are presented in Figures 2-9, 2-10, 2-11, and 2-12.

2. HEALTH EFFECTS

Figure 2-9. Serum Total Cholesterol Levels Relative to Serum PFOA Levels
(Presented as percent change in cholesterol levels)

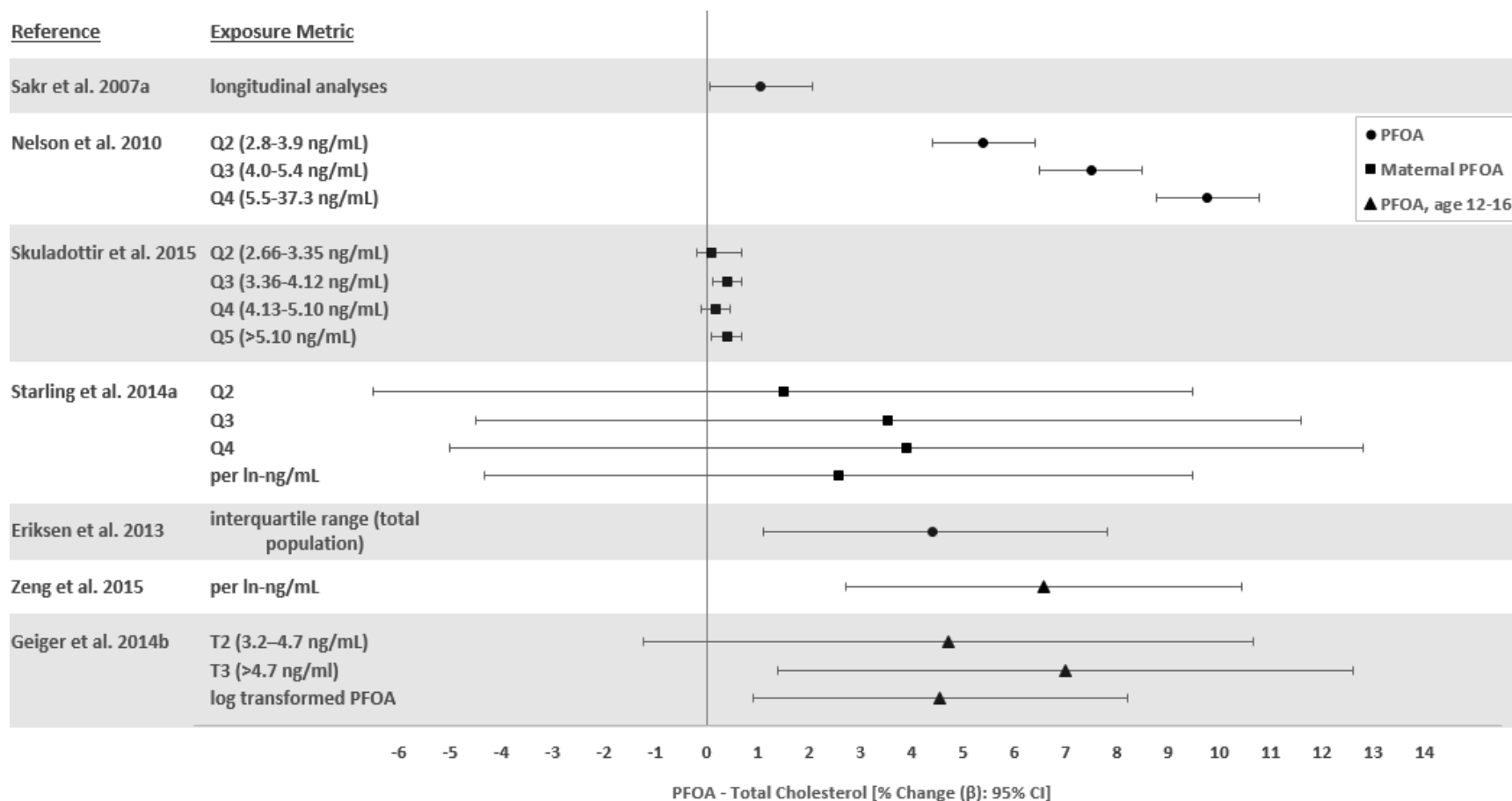

2. HEALTH EFFECTS

Figure 2-10. Risk of Abnormal Cholesterol Levels Relative to PFOA Levels (Presented as Adjusted Ratios)

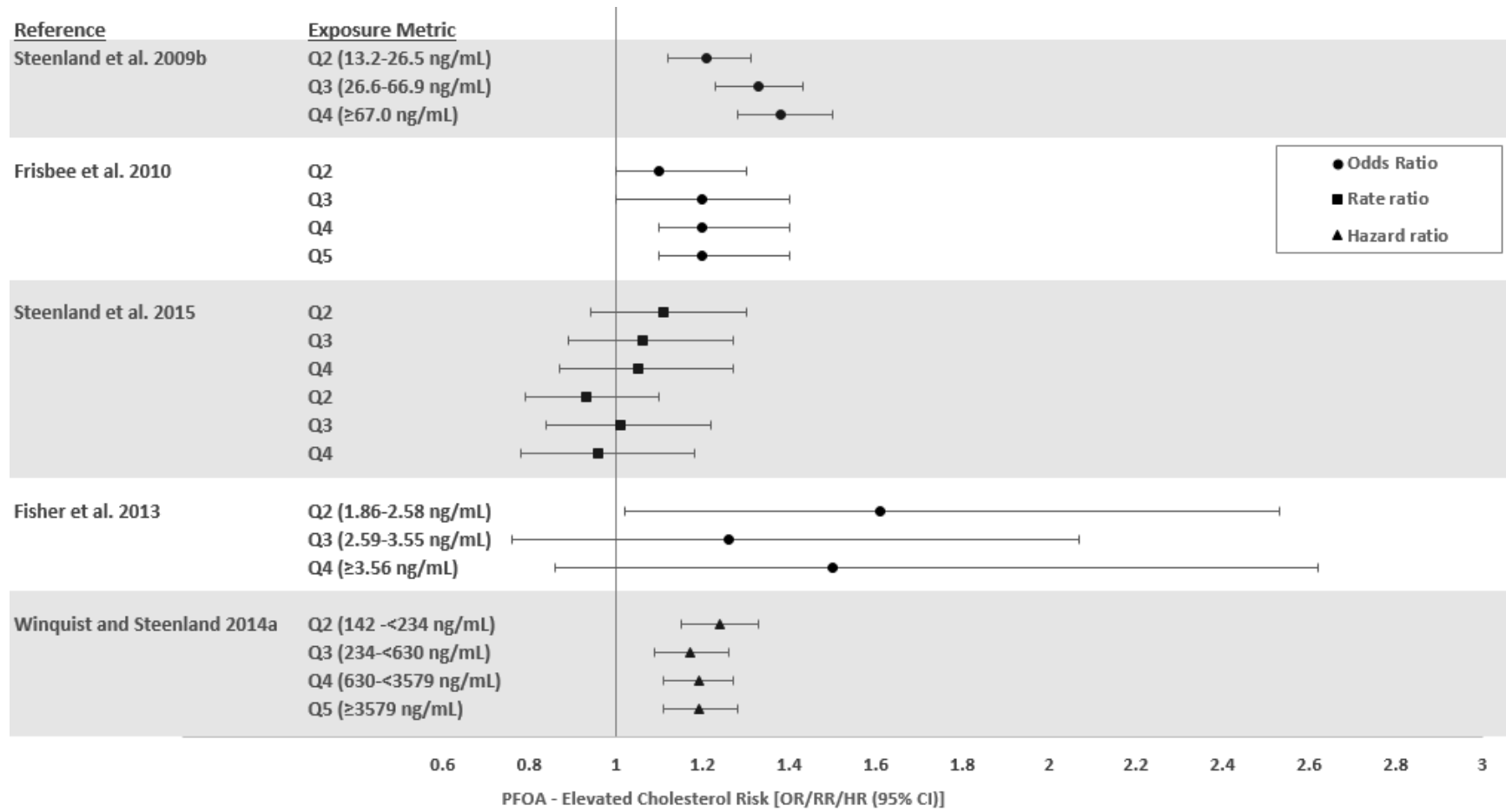

2. HEALTH EFFECTS

Figure 2-11. Serum LDL Cholesterol Levels Relative to Serum PFOA Levels
 (Presented as percent change in LDL cholesterol levels)

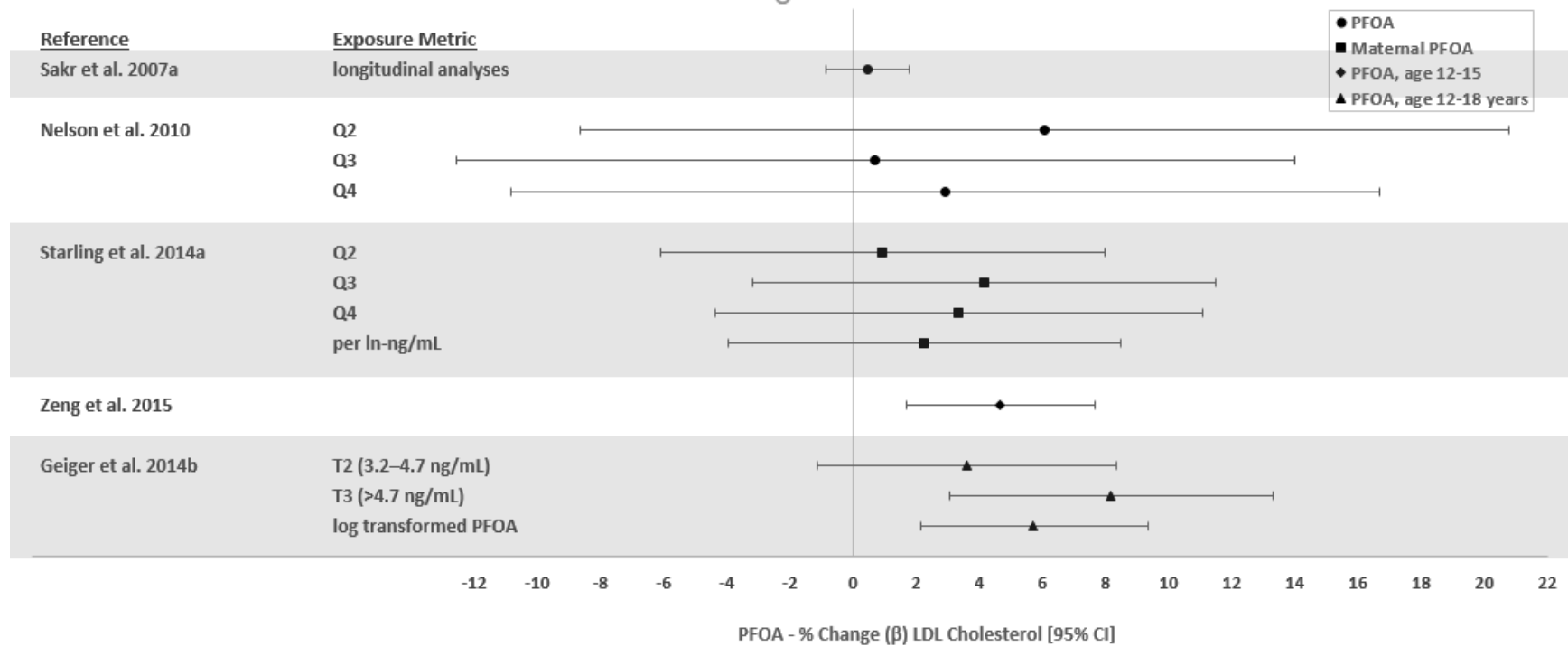

2. HEALTH EFFECTS

Figure 2-12. Risk of Abnormal LDL Cholesterol Levels Relative to PFOA Levels (Presented as Adjusted Ratios)

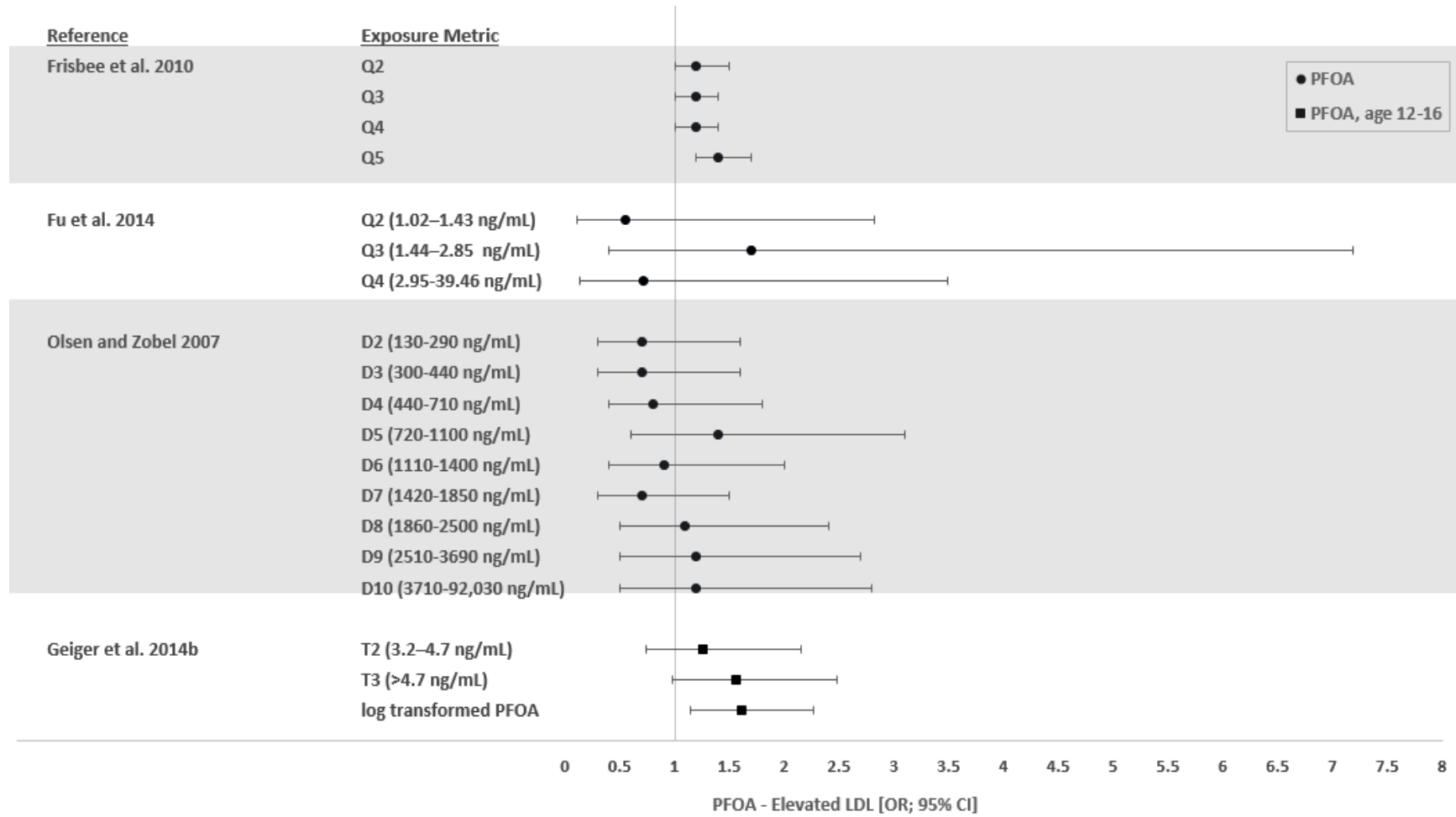

2. HEALTH EFFECTS

A study of workers at a manufacturing facility in Italy found higher total cholesterol and non-high-density lipoprotein (HDL)-cholesterol levels (non-HDL cholesterol was estimated by subtracting HDL cholesterol from total cholesterol) in the PFOA-exposed workers, as compared to levels in workers who were not exposed to PFOA (Costa 2004). A second study at this facility (Costa et al. 2009) also found an association between serum PFOA levels and total cholesterol levels, but no association with HDL cholesterol levels. No associations were found for HDL cholesterol or triglyceride levels. In another small study of workers at a fluorochemical facility in China (Wang et al. 2012), no associations between serum PFOA and total cholesterol, LDL cholesterol, or triglyceride levels were observed; the study did find an inverse association between serum PFOA and HDL cholesterol levels.

Several studies have examined workers at 3M facilities in Cottage Grove, Minnesota, Decatur, Alabama, and/or Antwerp, Belgium; workers at these facilities were also exposed to high levels of PFOS. Gilliland and Mandel (1996) examined workers at the Cottage Grove facility in 1990 and found no associations between serum fluorine levels (used as a surrogate for PFOA) and total cholesterol, LDL cholesterol, or HDL cholesterol. In a follow-up to this study, Olsen et al. (2000) examined workers in 1993, 1995, and 1997; only 17 workers were examined at all three time periods, 21 workers were examined in 1995 and 1997, and 68 workers were examined in 1993 and 1995. The study did not adjust for the use of cholesterol-lowering medication. When workers were categorized by blood PFOA levels (0–<1,000, 1,000–<10,000, and >10,000 ng/mL), no significant differences in serum cholesterol, LDL cholesterol, HDL cholesterol, or triglyceride levels were found at any of the monitoring periods. A study in workers at the three 3M facilities, most of whom were not taking cholesterol-lowering medications, did not find associations between serum PFOA levels and total cholesterol or LDL cholesterol levels; however, serum PFOA levels were associated with elevated triglyceride levels and inversely associated with HDL cholesterol levels (Olsen and Zobel 2007). The study did not find increases in the risk of elevated total cholesterol (≥ 200 mg/dL), elevated LDL cholesterol (≥ 130 mg/dL), elevated triglyceride (≥ 150 mg/dL), or decreased HDL cholesterol (≤ 40 mg/dL) levels in workers with serum PFOA levels in the highest deciles. In addition to these cross-sectional studies, two longitudinal studies were conducted at these facilities. Using data for 174 workers with medical surveillance data in 2000 and 1997 and/or 1995, Olsen et al. (2003a) found that serum PFOA was a significant predictor of cholesterol and triglyceride levels, which was primarily due to 21 workers at the Antwerp facility (mean serum level 8,400 ng/mL) whose serum PFOA levels increased over time. In a longitudinal study, Olsen et al. (2012) examined workers (none of the subjects reported using cholesterol-lowering medication) involved in the demolition of 3M perfluoroalkyl manufacturing facilities; serum PFOA and lipid levels were measured prior to the demolition and after demolition (mean time interval of 164 days). The mean baseline serum PFOA levels

2. HEALTH EFFECTS

were 881 ng/mL in 14 3M workers with prior PFOA or PFOS exposure and 28.9 ng/mL in the remaining 165 workers. Among the 119 workers whose serum PFOA/PFOS levels (mean increase 50.9 ng/mL) increased during the observation period, there was a significant increase in HDL cholesterol levels, but no change in total cholesterol or non-HDL cholesterol levels. No significant alterations in serum lipid levels were observed in the 55 workers whose serum PFOA/PFOS levels decreased during the observation period. In workers whose baseline levels of PFOA and PFOS were <15 and <50 ng/mL, respectively, there were no significant differences between pre- and post-exposure serum lipid levels.

Investigators have also examined workers at the DuPont Washington Works facility in West Virginia. In a cross-sectional study, Sakr et al. (2007b) found associations between serum PFOA levels and total cholesterol, LDL cholesterol, and very-low-density lipoprotein (VLDL) cholesterol levels in all subjects and in a subset of subjects not taking cholesterol-lowering medication. The study did not find any association between serum PFOA and HDL cholesterol or triglyceride levels. In a second study, Steenland et al. (2015) did not find an association between estimated serum PFOA levels and the occurrence of elevated cholesterol levels that required medication. In a longitudinal study of workers who had at least two serum PFOA measurements between 1979 and 2004, Sakr et al. (2007a) found a positive association between serum PFOA and total cholesterol levels; no associations with triglycerides, LDL cholesterol, or HDL cholesterol were found. Total cholesterol levels increased 1.06 mg/dL for each 1,000 ng/mL increase in serum PFOA.

Several studies have been conducted of residents living near the Washington Works facility. A study by Emmett et al. (2006b) of adults and children living in a community serviced by the Little Hocking Water Authority did not find an association between serum PFOA levels and total cholesterol levels; the study included an adjustment for the use of cholesterol-lowering medication. Four larger-scale studies of participants in the C8 Science Panel studies found associations between serum PFOA levels and serum lipid levels (Fitz-Simon et al. 2013; Frisbee et al. 2010; Steenland et al. 2009b; Winqvist and Steenland 2014a). Positive associations between serum PFOA levels and total cholesterol and LDL cholesterol were found in a study of over 12,000 children and adolescents, with mean serum PFOA levels of 32.6 ng/mL in children (aged 1.0–11.9 years) and 26.3 ng/mL in adolescents (aged 12.0–17.9 years) (Frisbee et al. 2010). Serum PFOA was also positively associated with triglyceride levels. Additionally, there was an increased risk of elevated cholesterol (≥ 170 mg/dL) in subjects with serum PFOA levels in the 4th or 5th quintiles. Increased odds of high LDL cholesterol (≥ 110 mg/dL) were also observed for the 5th PFOA quintile (OR 1.4, 95% CI 1.2–1.7). The investigators noted that the dose-response relationship between serum PFOA and serum lipids was nonlinear, with greater increases in lipids observed at the

2. HEALTH EFFECTS

lower serum PFOA levels. Similar findings were reported in a study of >46,000 adults with a median serum PFOA level of 26.6 ng/mL; the study excluded subjects who reported taking cholesterol-lowering medication (Steenland et al. 2009b). Associations were found between serum PFOA levels and total cholesterol, LDL cholesterol, and non-HDL cholesterol; a positive association between serum PFOA and triglycerides was also found. No associations between serum PFOA levels and HDL cholesterol levels were found. Increased risks of having high cholesterol (≥ 240 mg/dL) were found in subjects with serum PFOA levels in the 2nd, 3rd, and 4th quartiles. The investigators noted that the odds of high cholesterol from the 1st to the 5th quartile were approximately 40% for PFOA, which may be important given that the Framingham study found that the risk of coronary heart disease was about 1.8 times higher in subjects with total cholesterol levels >240 mg/dL as compared to subjects with levels <200 mg/dL. Steenland et al. (2009b) also found an association between serum PFOA levels and total cholesterol levels in a study of 10,746 adults taking cholesterol-lowering medication. Using both groups of subjects (taking or not taking cholesterol-lowering medication), the investigators analyzed whether taking cholesterol-lowering medication was associated with lower serum PFOA levels, which may be indicative of reverse causality. Although serum PFOA levels were significantly lower in subjects taking cholesterol-lowering medication, the difference between the groups was low (4%). Using estimated cumulative serum PFOA levels as the exposure metric, Winquist and Steenland (2014a) found increased risks of hypercholesterolemia at cumulative exposure levels ≥ 142 ng/mL. In a longitudinal study by Fitz-Simon et al. (2013), adults participating in the C8 Health Project and not taking cholesterol-lowering medication were examined twice, with an average of 4.4 years between examinations. Mean serum PFOA levels were 74.8 ng/mL at the first examination and 30.8 ng/mL at the second examination. In subjects whose serum PFOA levels halved between examinations, there was a 3.6% decrease in LDL cholesterol levels and 1.7% decrease in total cholesterol levels. However, there were very small changes in LDL cholesterol and total cholesterol levels in subjects whose serum PFOA levels decreased by >64% and there were slight increases in LDL cholesterol and total cholesterol levels in subjects whose serum PFOA levels fell by <50%. Changes in PFOA levels were not associated with changes in HDL cholesterol or triglyceride levels. Similarly, Wang et al. (2012) found no associations between serum PFOA levels and total cholesterol, HDL cholesterol, LDL cholesterol, or triglycerides in a study of adults living near a PFOA manufacturing facility in China; the mean serum PFOA level was 378.30 ng/mL and did not include an adjustment for the use of cholesterol-lowering medication.

General population studies were conducted in the United States, Canada, Denmark, Norway, Japan, China, and Taiwan; these studies have examined possible associations between serum PFOA levels and serum lipid levels in children, adolescents, pregnant women, and adults. In a study of 8–10-year-old

2. HEALTH EFFECTS

children (median serum PFOA of 9.3 ng/mL), Timmermann et al. (2014) found an association between serum PFOA and triglyceride levels among obese children; this association was not found among normal weight children. In a study of adolescents (12–18 years of age) participating in NHANES (mean serum PFOA level of 4.2 ng/mL), Geiger et al. (2014b) found associations between serum PFOA and total cholesterol and LDL cholesterol levels; no associations were found for HDL cholesterol or triglycerides. The study also found increased risks of elevated total cholesterol levels (>170 mg/dL) associated with serum PFOA levels. No alterations in the risk of elevated LDL cholesterol or triglycerides or decreased HDL cholesterol were found. Associations between serum total cholesterol, LDL cholesterol, and triglycerides have also been observed in a study of Taiwanese adolescents (12–15 years of age, median PFOA level of 9.3 ng/mL) (Zeng et al. 2015); no association was found for HDL cholesterol. A fourth study found associations between maternal PFOA levels and total cholesterol and LDL cholesterol in 7- and 15-year-old girls, but no associations for girls whose maternal PFOA levels were in the 2nd or 3rd tertiles (Maisonet et al. 2015b). No associations were found for HDL cholesterol or triglyceride levels.

Studies in adults have found mixed results for serum lipids. Using NHANES data for adults not taking cholesterol-lowering medication (mean serum PFOA level of 4.6 ng/mL), Nelson et al. (2010) found an association between serum PFOA levels and non-HDL cholesterol levels; no associations were found for total cholesterol, LDL cholesterol, or HDL cholesterol. Associations between serum PFOA levels and total cholesterol levels were also found in a study of Danish adults not taking cholesterol-lowering medication (mean serum PFOA level of 7.1 ng/mL) (Eriksen et al. 2013). A study in Chinese adults (median PFOA level of 1.43 ng/mL) also found associations between serum PFOA and total cholesterol and LDL cholesterol, with no associations for HDL cholesterol or triglycerides (Fu et al. 2014a). This study did not find increased risks of elevated total cholesterol, LDL cholesterol, or triglycerides or decreased HDL cholesterol associated with serum PFOA. A study of pregnant women in Denmark also found an association between serum PFOA (mean serum PFOA level of 4.1 ng/mL at gestation week 30) and total cholesterol levels (Skuladottir et al. 2015). No associations between serum PFOA levels and total cholesterol, LDL cholesterol, or non-HDL cholesterol levels were found in Canadian adults not taking cholesterol-lowering medication with a geometric mean serum PFOA level of 2.46 ng/mL (Fisher et al. 2013). In a second study of pregnant women (median PFOA level of 2.25 ng/mL at gestation week 18), no associations between plasma PFOA and total cholesterol, LDL cholesterol, or triglycerides were found (Starling et al. 2014a). The study did find an association between plasma PFOA and HDL cholesterol.

2. HEALTH EFFECTS

A number of epidemiology studies have reported associations between serum PFOA levels and serum lipid levels; the most consistently found alteration was for increased serum total cholesterol levels. Associations between serum PFOA and serum cholesterol levels have been observed in occupational (Costa 2004; Costa et al. 2009; Sakr et al. 2007a, 2007b), community (Fitz-Simon et al. 2013; Frisbee et al. 2010; Steenland et al. 2009b; Winquist and Steenland 2014a), and general population (Eriksen et al. 2013; Fu et al. 2014a; Geiger et al. 2014b; Skuladottir et al. 2015; Zeng et al. 2015) studies, whereas other investigators have not found associations in worker populations (Gilliland and Mandel 1996; Olsen et al. 2000; Olsen and Zobel 2007; Steenland et al. 2015; Wang et al. 2012), community populations (Emmett et al. 2006b; Wang et al. 2012), or general populations (Fisher et al. 2013; Nelson et al. 2010; Starling et al. 2014a). Longitudinal studies conducted in workers and highly exposed residents strengthen the interpretation of this association between serum PFOA and serum lipid levels. Serum PFOA levels were found to be a significant predictor of serum cholesterol levels in workers examined at least twice in a ≥ 5 -year period (Olsen et al. 2003a; Sakr et al. 2007a). Similarly, a study of highly-exposed residents examined twice with approximately 4 years between examinations found that there was a 1.7% decrease in serum total cholesterol levels in subjects whose serum PFOA levels decreased by 50% between examinations (Fitz-Simon et al. 2013). As noted in Steenland et al. (2010a), there is considerable variation in the strength of the association between PFOA and serum cholesterol, with the greatest changes in serum cholesterol occurring at lower PFOA levels. The change in cholesterol levels per ng/mL change in serum PFOA ranged from 0.0007, calculated from data from the Olsen et al. (2000) occupational exposure study, to 2.0 calculated from data from the Nelson et al. (2010) general population study; the mean serum PFOA levels in these studies were $\sim 22,000$ and 4 ng/mL respectively. In a clinical trial (results only available as an abstract), administration of APFO to patients with advanced refractory solid tumors at doses of 50–1,200 mg weekly for 6 weeks resulted in decreases in serum LDL cholesterol levels (it is unclear if this effect was observed at all dose levels) (MacPherson et al. 2011). These results are similar to those observed in laboratory animals, suggesting that the dose-response curve may be biphasic. Steenland et al. (2010a) and Frisbee et al. (2010) suggested that this may be due to a steep dose-response curve at low PFOA levels, which flattens out at higher PFOA levels and may be indicative of saturation. A similar pattern was also observed in the risks of elevated cholesterol per increases in serum PFOA levels (Figure 2-12). Several investigators have explored whether PFOA and cholesterol could be jointly affected or whether the associations were due to reverse causality (i.e., increased cholesterol resulted in increased serum PFOA levels). Butenhoff et al. (2012c) explored the issues of whether PFOA distributes into serum lipoprotein fractions, and whether increases in serum lipoproteins would result in increases in serum PFOA. They concluded that there was limited distribution to plasma lipoproteins, and that this was not a non-causal factor. The Steenland et al. (2009b) study found slightly lower serum

2. HEALTH EFFECTS

PFOA levels (4%) among individuals taking cholesterol medication, as compared to those not taking medication and noted that this was primarily a function of the large sample size. This finding does not support reverse causality.

Laboratory Animal Studies. Information from inhalation studies in animals is limited. Head-only exposure of male rats to 810 mg/m³ APFO dusts for 4 hours caused liver enlargement, but microscopically, the liver tissue appeared normal (Kennedy et al. 1986). Exposure head-only of male rats to 0, 1, 7.6, or 84 mg/m³ APFO dusts 6 hours/day, 5 days/week for 2 weeks resulted in significant increases in absolute and relative liver weight at 7.6 and 84 mg/m³ on exposure day 10; in rats from the 84 mg/m³ group, absolute and relative liver weights were still significantly increased 28 days after exposure ceased (Kennedy et al. 1986). The activities of serum enzymes markers of liver function were unremarkable except for alkaline phosphatase, which was significantly increased in the 7.6 and 84 mg/m³ groups immediately after exposure on day 10 and remained elevated in the 84 mg/m³ group on day 14 of recovery. Histopathological changes were restricted to the 7.6 and 84 mg/m³ groups and consisted of panlobular and centrilobular hepatocellular hypertrophy and necrosis. Panlobular hepatocellular hypertrophy was seen only after the 10th exposure, but was limited to the centrilobular hepatocytes 14 or 28 days after exposure terminated, and was absent 42 days following cessation of exposure. Inhalation exposure of pregnant rats to 25 mg/m³ APFO dusts 6 hours/day during GDs 6–15 induced an 18% increase in absolute liver weight (Staples et al. 1984); no significant effect was reported in rats exposed to ≤10 mg/m³.

Nose-only exposure of male CD rats to 67 mg/m³ ammonium perfluorononanoate dusts for 4 hours induced significant increases (28–37%) in absolute and relative liver weight, assessed 5 and 12 days after exposure (Kinney et al. 1989). Histopathological examinations were not conducted in this study.

The liver is the main target organ for perfluoroalkyl compounds in animals following short- or long-term oral exposures. The hepatic response to exposure to many perfluoroalkyl compounds, particularly in rodents, is initiated by the activation of the nuclear hormone receptor, PPAR α , which triggers a characteristic sequence of morphological and biochemical events characterized by liver hypertrophy and alteration of a wide range of enzymes, particularly those involved in lipid metabolism. It appears that PFOA can also damage the liver via a method independent of PPAR α . The most sensitive liver effect observed in rats and mice after acute oral exposure to PFOA is an increase in liver weight (Cook et al. 1992; Das et al. 2017; Eldasher et al. 2013; Haughom and Spydevold 1992; Ikeda et al. 1985; Iwai and Yamashita 2006; Kawashima et al. 1995; Kennedy 1987; Liu et al. 1996; Loveless et al. 2006; Pastoor et

2. HEALTH EFFECTS

al. 1987; Permadi et al. 1992, 1993; Qazi et al. 2012; White et al. 2009; Wolf et al. 2007, 2008a; Xie et al. 2003; Yahia et al. 2010; Yang et al. 2001, 2002b). In rats orally administered 50 mg/kg/day PFOA for 1, 3, or 7 days, a 10% increase in liver weight was observed after the first dose; however, the relative liver weight was not significantly different from controls (Pastoor et al. 1987). After 3 days of exposure, the relative liver weight was significantly higher (36%) than controls. Similarly, in mice, exposure to 390 mg/kg/day PFOA in the diet resulted in a significant increase in liver weight after 5 days of exposure, but not after 2 days of exposure (Permadi et al. 1992). The lowest LOAELs for increased relative liver weight in rats were 4.7 mg/kg/day in a 7-day study (Kawashima et al. 1995) and 2 mg/kg/day in a 14-day study (Liu et al. 1996); these studies also identified NOAELs of 2.4 and 0.2 mg/kg/day, respectively. In mice, the lowest LOAEL for increases in liver weight was 1 mg/kg/day PFOA administered in the diet for 10 days (Yang et al. 2001) or administered via gavage for 7 days (Eldasher et al. 2013; Wolf et al. 2008a). Pastoor et al. (1987) noted that oral administration of 50 mg/kg/day PFOA to rats for 7 days resulted in a 2-fold increase in absolute and relative liver weight, but no significant change in total deoxyribonucleic acid (DNA), indicating that the hepatomegaly represented hypertrophy rather than hyperplasia. Few acute-duration studies included histological examinations of the liver. Centrilobular and midzonal hypertrophy was observed in mice administered 1 or 3 mg/kg/day PFOA via gavage for 7 days; panlobular hypertrophy with cytoplasmic vacuolation was observed at 10 mg/kg/day (Wolf et al. 2008a). Qazi et al. (2010a) reported hepatocellular hypertrophy in mice exposed to 3.5 mg/kg/day PFOA in the diet for 10 days. Elcombe et al. (2010) reported hepatocellular hypertrophy in rats orally exposed to 18 mg/kg/day for 7 days, but not after 1 day of exposure. Increases in steatosis and triglyceride levels were observed in the livers of mice administered 10 mg/kg/day for 7 days (Das et al. 2017). A related liver effect was the finding of reduced serum cholesterol and triacylglycerol levels in rats administered 16 mg/kg/day PFOA in the diet for 7 days (Haughom and Spydevold 1992) and decreases in serum cholesterol and triglyceride levels in rats administered 18 mg/kg/day PFOA via gavage for 7 days (Elcombe et al. 2010).

Similar to the acute-duration studies, intermediate-duration oral exposure to PFOA resulted in increases in absolute and relative liver weights in rats (Biegel et al. 2001; Butenhoff et al. 2004b; Griffith and Long 1980; Perkins et al. 2004) and mice (Abbott et al. 2007; Ahmed and Abd Ellah 2012; Albrecht et al. 2013; Griffith and Long 1980; Kennedy 1987; Lau et al. 2006; Son et al. 2008; Wolf et al. 2007). The lowest dose resulting in increases in liver weight in rats was 0.96 mg/kg/day, observed following gavage administration of APFO for 28 days (Loveless et al. 2008); the lowest dose in mice was 0.5 mg/kg/day, observed in two 28-day studies using APFO (Kennedy 1987; Son et al. 2008). No significant alterations in liver weight were observed in rats administered 0.29 mg/kg/day for 28 days (Loveless et al. 2008) or in

2. HEALTH EFFECTS

mice exposed to 0.2 mg/kg/day for 21 days (Kennedy 1987). Hepatocellular hypertrophy was the predominant histopathological alteration in rats (Cui et al. 2009; Griffith and Long 1980; Loveless et al. 2008; Perkins et al. 2004) and mice (Albrecht et al. 2013; Filgo et al. 2015a; Griffith and Long 1980; Loveless et al. 2008; Tan et al. 2013); the severity of the hypertrophy was dose-related (Filgo et al. 2015a; Loveless et al. 2008). At higher doses, focal necrosis was observed (29 mg/kg/day in rats and 0.96 mg/kg/day in mice exposed for 28 days) (Loveless et al. 2008). Fatty changes were observed in rats administered 20 mg/kg/day for 28 days (Cui et al. 2009) and mice administered 9.6 mg/kg/day (Loveless et al. 2008). No significant alterations in liver weight or histopathology were observed in rats allowed to recover for 8 weeks following a 13-week exposure to 0.6–6.5 mg/kg/day (Perkins et al. 2004). Intermediate-duration exposure to PFOA also resulted in decreases in serum HDL cholesterol levels in rats and mice administered ≥ 0.29 or 0.96 mg/kg/day, respectively, for 28 days (Loveless et al. 2008). Serum cholesterol levels were decreased in rats administered 0.29 or 0.96 mg/kg/day (no changes were observed at higher doses) and in mice administered 9.6 or 29 mg/kg/day (Loveless et al. 2008). Similarly, serum triglyceride levels were decreased in rats administered 0.29–9.6 mg/kg/day and in mice administered 9.6 or 29 mg/kg/day (Loveless et al. 2008). In a study of mice fed a western-type diet, increases in plasma cholesterol levels were observed after 6 weeks of dietary exposure to 0.55 mg/kg/day in BALB/c or C57BL/6 mice (Rebholz et al. 2016). The results of this study suggest that diet (fat intake and/or cholesterol levels) may influence the response to PFOA and may account for some of the differences observed in humans and rats fed a standard diet, which is typically low in fat.

Chronic exposure of rats to PFOA resulted in hepatomegalocytosis, hepatocellular necrosis, and portal mononuclear cell infiltration after a 1-year exposure to 15 mg/kg/day in the diet (3M 1983). A 2-year exposure to 15 mg/kg/day resulted in hepatomegalocytosis, cystoid degeneration, and portal mononuclear cell infiltration (3M 1983). The study also found significant increases in ALT and AST levels in male rats exposed to 1.5 mg/kg/day. A second chronic exposure study found significant increases in relative liver weight in rats exposed to 13.6 mg/kg/day in the diet for 2 years; no non-neoplastic lesions were noted in the liver (Biegel et al. 2001).

Studies in monkeys suggest that longer-term exposure may also result in liver toxicity. Significant increases in absolute and relative liver weight were observed in Cynomolgus monkeys exposed to 20/30 mg/kg/day administered via capsules for 26 weeks (Butenhoff et al. 2002). A significant increase in absolute, but not relative, liver weight was also observed in monkeys administered 3 or 10 mg/kg/day. However, no histological alterations were observed in the livers at the doses tested. Similarly, no histological alterations were observed in the livers of Cynomolgus monkeys administered 2 or

2. HEALTH EFFECTS

20 mg/kg/day via capsules for 30 days (Thomford 2001) or Rhesus monkeys administered 3 or 10 mg/kg/day via gavage for 90 days (Griffith and Long 1980). Significant increases in serum triglyceride levels were observed in the 10 and 20/30 mg/kg/day groups; the increases were statistically significant at only some of the time points (Butenhoff et al. 2002). At 10 mg/kg/day, increases in serum triglyceride levels at 4, 10, and 14 weeks of exposure were significantly higher than pre-treatment levels. Increases in cholesterol levels were only observed in the 20/30 mg/kg/day group after 13 weeks of exposure, but not after 26 weeks. No alterations in serum cholesterol or triglyceride levels were observed in the Thomford (2001) study.

Several studies have examined PPAR α -null mice to assess whether PFOA-induced liver effects can also occur via a mechanism not involving peroxisome proliferation. Similar to wild-type mice, exposure to PFOA resulted in significant increases in liver weight (Abbott et al. 2007; Das et al. 2017; Minata et al. 2010; Wolf et al. 2008a; Yang et al. 2002b). Abbott et al. (2007) found that the effect level was slightly higher in PPAR α -null mice than wild-type mice (3 versus 1 mg/kg/day) following oral exposure on GDs 1–17 (liver weights measured at weaning). Wolf et al. (2008a) and Minata et al. (2010) reported the same effect level (1 or 5 mg/kg/day, respectively) in PPAR α -null mice and wild-type mice administered PFOA via gavage for 7 days or 4 weeks. Wolf et al. (2008a) found dose-related increases in hepatocellular cytoplasmic vacuoles at ≥ 1 mg/kg/day and suggested that the increase in liver weight was due to the accumulation of PFOA in the hepatocytes rather than a toxic response. Hepatocyte proliferation was also observed at 10 mg/kg/day. Unlike the Wolf et al. (2008a) study, the Minata et al. (2010) 4-week study reported hepatocellular hypertrophy and microvesicular steatosis in the PPAR α -null mice (no incidence data were provided and it is unclear at what dose levels these effects were found); cytoplasmic vacuolation was also reported in the hepatocytes. Filgo et al. (2015a) also reported hepatocellular hypertrophy in PPAR α -null mice; the LOAEL was 3 mg/kg/day, which was higher than the LOAEL of 0.3 mg/kg/day found in wild-type mice. Minata et al. (2010) also reported cholangiopathy in both the wild-type and PPAR α -null mice, but noted that the effect was more intensive in the PPAR α -null mice. No significant alterations in steatosis or triglyceride accumulation were observed in PPAR α -null mice administered 10 mg/kg/day for 7 days, but were observed in wild-type mice (Das et al. 2017). Additionally, significant decreases in serum total cholesterol levels at 5.2 and 10.2 mg/kg/day and increases at 20.7 mg/kg/day were observed in the PPAR α -null mice; significant decreases in total cholesterol were observed in the wild-type mice at 10.2 and 20.7 mg/kg/day doses. Serum triglyceride levels were increased in both strains at 5.2 and 10.2 mg/kg/day doses and in the PPAR α -null mice at 20.7 mg/kg/day (Minata et al. 2010).

2. HEALTH EFFECTS

Intermittent application of 20, 200, or 2,000 mg/kg APFO to the skin of rats for 2 weeks resulted in the presence of one or more foci of coagulative necrosis in the livers from all treated groups (Kennedy 1985). The Kupffer cells within the foci of hepatocellular necrosis contained large vesicular nuclei and were markedly increased in number. At 2,000 mg/kg/day, these changes were seen in three out of five rats killed on the 10th day of exposure, in three out of five rats killed on recovery day 14, and in one out of five rats killed on recovery day 42. This lesion occurred in two out of five rats from the 20 mg/kg/day dose group killed on day 10 of exposure. Serum ALT activity appeared elevated at termination of exposure in a dose-related manner, but without achieving statistical significance. A similar trend was seen for AST activity, but achieving statistical significance in the high-dose group. The blood concentrations of organofluorine on the 10th day of exposure were 10.2, 52.4, 79.2, and 117.8 µg/mL in the control, low-, mid-, and high-dose groups, respectively. A study in mice reported that application of 6.25 mg/kg/day PFOA on the dorsal surface of each ear for 4 days resulted in a 52% increase in absolute liver weight (Fairley et al. 2007); no significant effect occurred after application of 2.5 mg/kg/day.

Summary. Epidemiology studies examining the hepatotoxicity of PFOA have examined three outcomes—risk of liver disease, evidence of hepatocellular damage (as measured by alterations in serum hepatic enzymes and bilirubin levels), and alterations in serum lipid levels (total cholesterol, LDL cholesterol, HDL cholesterol, and triglycerides)—among workers, residents living near a PFOA manufacturing facility with high levels of drinking water contamination, and the general population. Exposure to PFOA does not appear to be associated with increased risks of liver disease in workers or highly exposed community members. The epidemiology studies have found associations between serum PFOA levels and increases in serum ALT, AST, and GGT enzyme levels and decreases in serum bilirubin levels. However, the results have not been consistently found, and serum enzyme levels were typically within the normal range. Four studies examined the risk of serum enzyme levels outside of the normal range; the results were mixed for the risk of elevated ALT, with two studies finding an increased risk and two studies finding no association. A number of occupational, community, and general population studies have found associations between serum PFOA levels and serum total cholesterol levels; several studies have also found no associations. Studies examining the change in cholesterol levels per change in serum PFOA levels have found greater increases in serum cholesterol levels associated with serum PFOA levels at the lower range of PFOA levels and the dose-response curve suggests a biphasic relationship. Positive associations have also been observed for LDL cholesterol, although associations have not been consistently found. In general, no consistent associations were found between serum PFOA and HDL cholesterol or triglyceride levels. Studies in laboratory animals have found strong associations between PFOA exposure and hepatotoxicity. Liver effects have been observed in rats exposed to airborne APFO

2. HEALTH EFFECTS

dusts; in rats, mice, and monkeys following oral exposure for acute-, intermediate-, or chronic-durations; and in rats following dermal exposure. The observed effects typically include increases in liver weight, hepatocellular hypertrophy, and decreases in serum cholesterol and triglyceride levels. Other effects that have been observed include hyperplasia, necrosis, and fatty degeneration. Available evidence suggests that the increased liver weight, hypertrophy, and serum lipid alterations are likely due to PPAR α initiation and therefore, may not be relevant to humans. However, other mechanisms of liver toxicity are also involved, as evidenced by liver effects observed in PPAR α -null mice (Das et al. 2017; Minata et al. 2010; Wolf et al. 2008a). In contrast to the results observed in epidemiology studies, an experimental study in humans exposed to PFOA (MacPherson et al. 2011) and human exposure to other PPAR α agonists, such as fibrates (Staels et al. 1998), suggest that hypolipidemic effects, similar to those observed in rodents, may occur in humans exposed to PFOA, although humans may not be as sensitive as rodents.

PFOS

Epidemiology Studies—Liver Disease. Several studies have examined the possible association between PFOS exposure and liver diseases. No increases in deaths from cirrhosis of the liver were found in workers at the 3M facility in Decatur, Alabama (Alexander et al. 2003). Another study of workers at this facility found no significant alterations in the episodes of care for all liver disorders or all biliary duct disorders (Olsen et al. 2004a). However, among workers with at least 10 years of high potential exposure to PFOS, there were significant increases in episodes of care for cholelithiasis or acute cholecystitis and for all biliary tract disorders. A third study of workers at a PFOS facility in Decatur, Alabama did not find increases in cholelithiasis, cholecystitis, or liver disease (including cirrhosis and hepatitis) (Grice et al. 2007).

Epidemiology Studies—Hepatic Serum Enzymes and Bilirubin Levels. A series of studies conducted by Olsen and associates evaluated liver function (as assessed by serum liver enzymes) in workers at several 3M facilities involved in PFOS production. Using health data collected in 1995 and 1997, Olsen et al. (1999) did not find associations between serum PFOS and serum ALT, AST, or GGT enzymes at PFOS levels <6,000 ng/mL; a positive association with total bilirubin levels was found. No conclusions were drawn from the few workers with serum PFOS \geq 6,000 ng/mL due to their small number (seven in 1995 and five in 1997 data). Similarly, no association of ALT, AST, or GGT and serum PFOA levels were observed in groups of workers at these facilities examined in 1993 (111 subjects), 1995 (80 subjects), and/or 1997 (74 subjects) (Olsen et al. 2000). A subsequent evaluation of workers from the same plants, but that included women and a longitudinal analysis of the workers, reported that, after adjusting for

2. HEALTH EFFECTS

potential confounding factors, there were no substantial changes in hepatic parameters (Olsen et al. 2003a). GGT levels in females and ALT levels in males with PFOS levels in the 4th quartile were significantly elevated in comparisons between individuals with serum PFOS levels in the 4th quartile to those with levels in the 1st quartile; however, there were no statistical adjustments for potential confounders. In contrast to these findings in workers, Gallo et al. (2012) reported significant increases in the risks of elevated ALT, GGT, and bilirubin levels in a study of C8 participants. Conflicting results have been found in general populations studies. Studies using the NHANES data set (Gleason et al. 2015; Lin et al. 2010) did not find associations between serum PFOS and ALT, AST, GGT, or total bilirubin levels. No increases in the risk of elevated levels of ALT, AST, or GGT were found (Gleason et al. 2015), although there was an increased risk of elevated total bilirubin levels. In a study of adults in Japan (Yamaguchi et al. 2013), significant correlations between serum PFOS and ALT, AST, and GGT levels were found.

Epidemiology Studies—Serum Lipids. Occupational, community, and general population studies have examined possible associations between serum PFOS levels and serum lipids; these data are summarized in Table 2-12. A graphical presentation of differences in total cholesterol and LDL cholesterol levels relative to serum PFOS levels and the risks of elevated total cholesterol and LDL cholesterol are presented in Figures 2-13, 2-14, 2-15, and 2-16.

In the Olsen occupational studies, significantly higher serum total cholesterol levels were found in workers with serum PFOS levels between 3,000 and 6,000 ng/mL (Olsen et al. 1999, 2003a). However, the studies found mixed results for associations between serum PFOS and other serum lipids, with one study finding an association with LDL cholesterol (Olsen et al. 1999) and the other finding an association with triglycerides (Olsen et al. 2003a). Longitudinal analysis was conducted using data for 174 workers with medical surveillance data in 2000 and 1997 and/or 1995 (Olsen et al. 2003a). No significant differences in serum PFOS levels were observed across the three time periods, and serum PFOS level was not a significant predictor of cholesterol or triglyceride levels.

Two large-scale studies of participants in the C8 Science Panel studies found associations between serum PFOS levels and serum lipid levels (Frisbee et al. 2010; Steenland et al. 2009b). Associations between serum PFOS levels and total cholesterol, LDL cholesterol, and HDL cholesterol were found in a study of over 12,000 children and adolescents; the mean serum PFOS levels were 20.7 ng/mL in children (aged 1.0–11.9 years) and 19.3 ng/mL in adolescents (aged 12.0–17.9 years) (Frisbee et al. 2010). Similar

2. HEALTH EFFECTS

Figure 2-13. Serum Total Cholesterol Levels Relative to Serum PFOS Levels
(Presented as percent change in cholesterol levels)

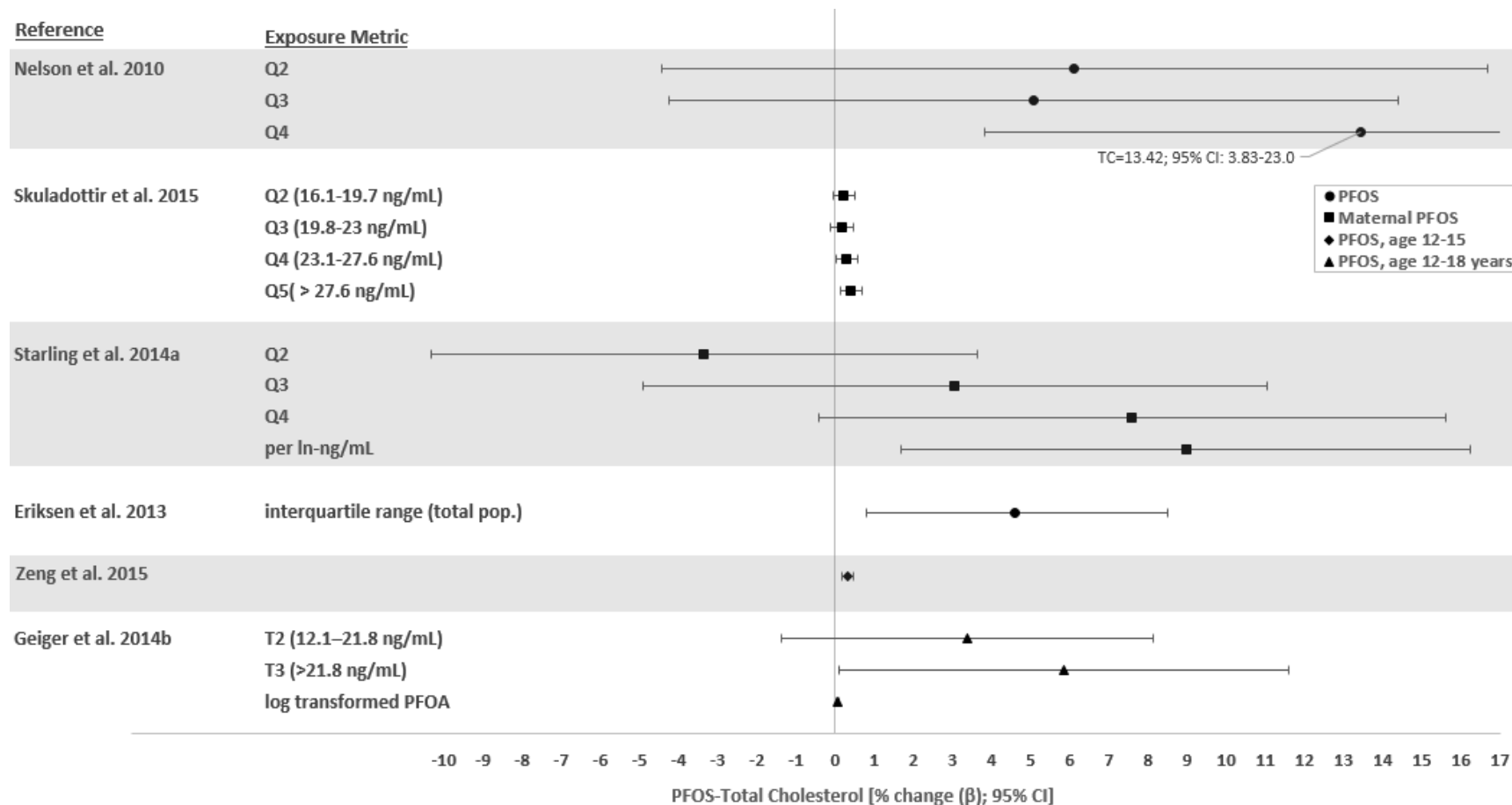

2. HEALTH EFFECTS

Figure 2-14. Risk of Abnormal Cholesterol Levels Relative to PFOS Levels (Presented as Adjusted Ratios)

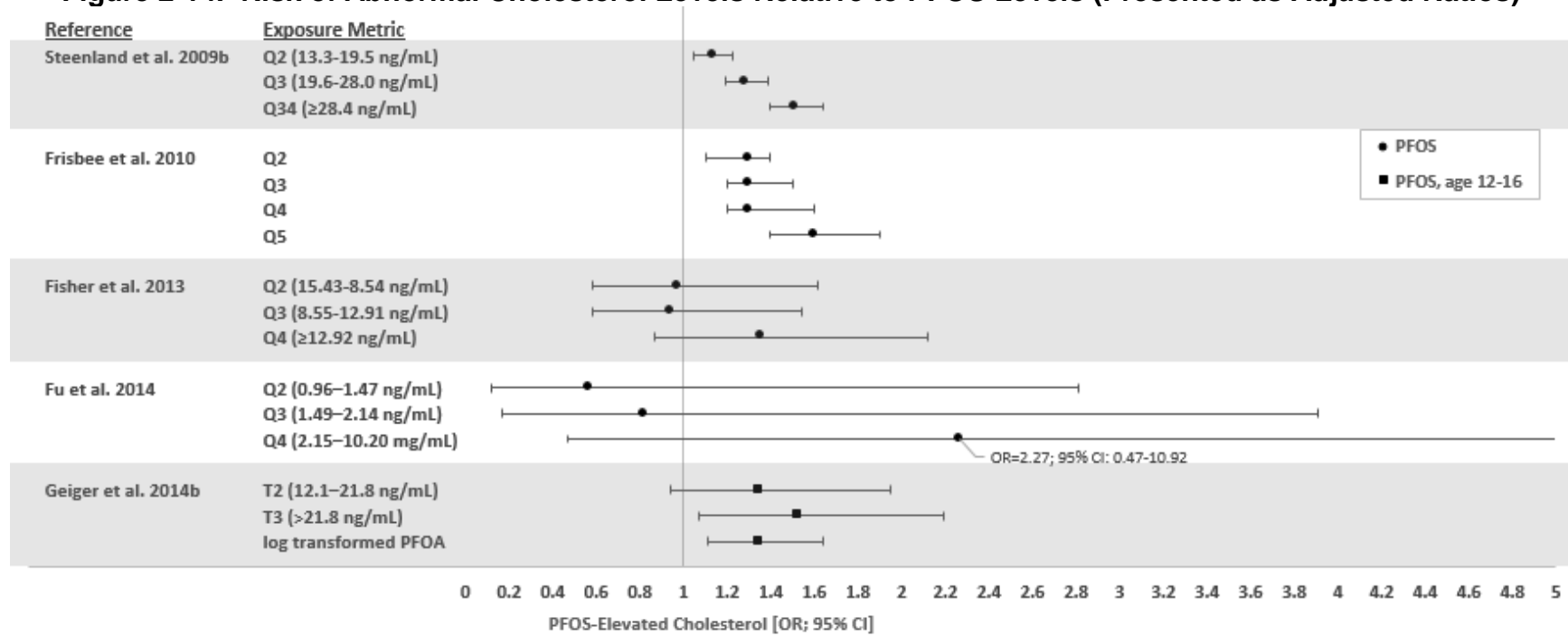

2. HEALTH EFFECTS

Figure 2-15. Serum LDL Cholesterol Levels Relative to Serum PFOS Levels
 (Presented as percent change in LDL cholesterol levels)

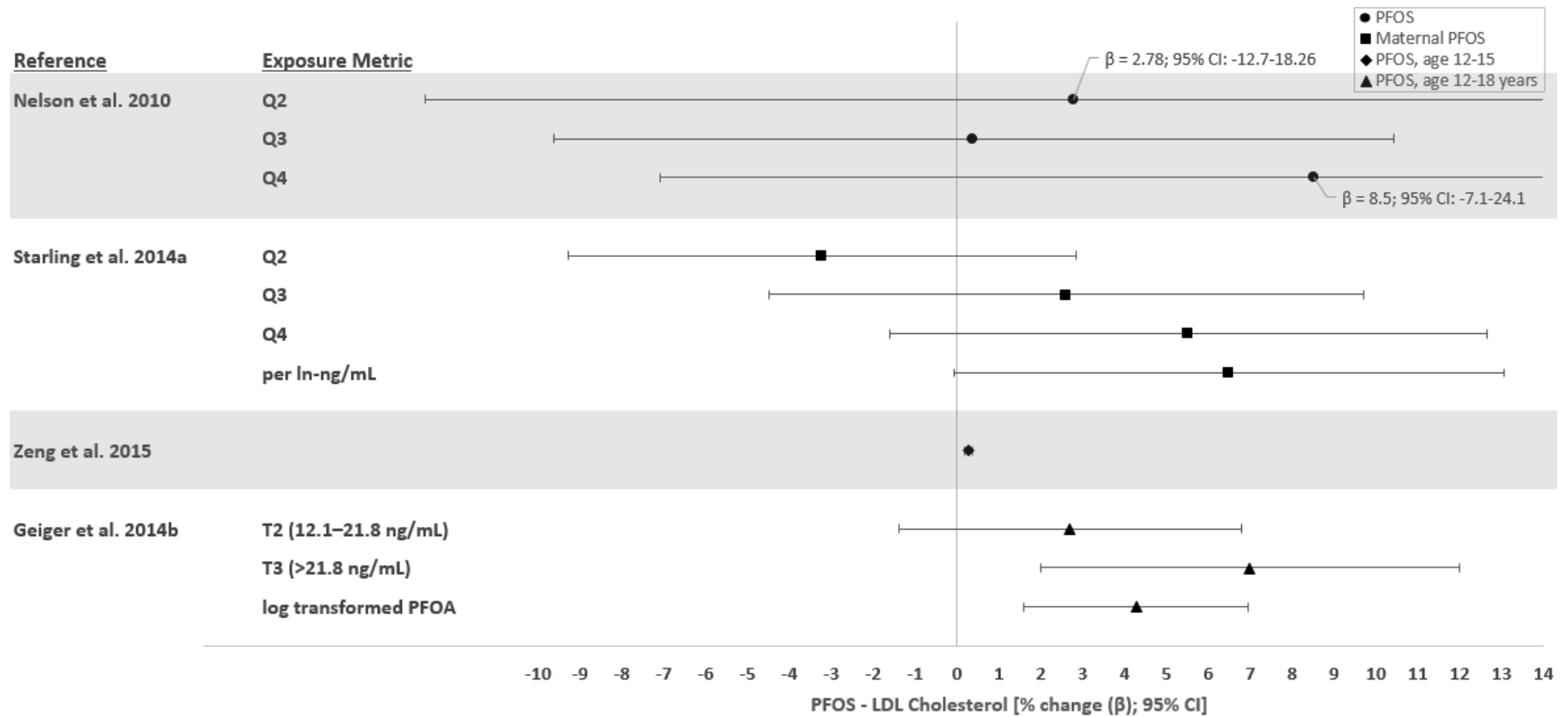

2. HEALTH EFFECTS

Figure 2-16. Risk of Abnormal LDL Cholesterol Levels Relative to PFOS Levels (Presented as Adjusted Ratios)

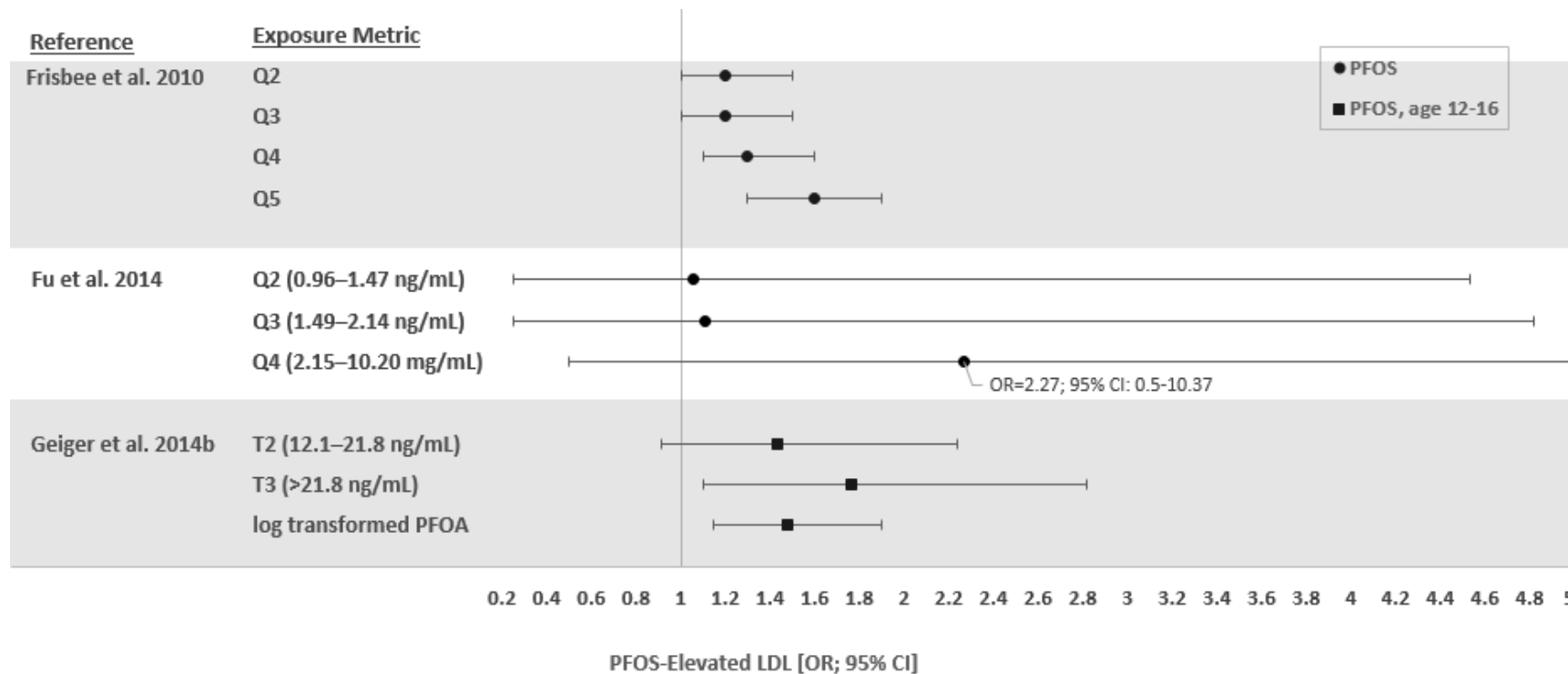

2. HEALTH EFFECTS

findings were reported in a study of adults with a median serum PFOS level of 19.6 ng/mL; the study excluded subjects who reported taking cholesterol-lowering medication (Steenland et al. 2009b). Associations were found between serum PFOS and total cholesterol, LDL cholesterol, and triglyceride levels, but not with HDL cholesterol. Participants with serum PFOS levels in the 2nd, 3rd, and 4th quartiles also had elevated risks of high cholesterol levels. The investigators noted that the odds of high cholesterol from the 1st to the 5th quartile was approximately 50% for PFOS, which may be important given that the Framingham study found that the risk of coronary heart disease was about 1.8 times higher in subjects with total cholesterol levels >240 mg/dL as compared to subjects with levels <200 mg/dL. Steenland et al. (2009b) also examined over 10,000 participants who were taking cholesterol-lowering medication; an association between serum PFOS and total cholesterol levels was found in this group. Using both groups of subjects (taking or not taking cholesterol-lowering medication), the investigators analyzed whether taking cholesterol medication was associated with lower serum PFOA or PFOS levels, which may be indicative of reverse causality; no differences in serum PFOS levels were found between the two groups.

General population studies were conducted in the United States, Canada, and several European and Asian countries; these studies have found mixed results for associations between serum PFOS levels and serum lipids. Some studies have found associations between serum PFOS levels and serum total cholesterol (Nelson et al. 2010; Skuladottir et al. 2015; Starling et al. 2014a) and HDL cholesterol (Châtaeu-Degat et al. 2010); inverse associations between serum PFOS and HDL cholesterol (Starling et al. 2014a) and triglycerides (Châtaeu-Degat et al. 2010) were also found. However, other studies in adults have not found associations between serum PFOS and total cholesterol (Châtaeu-Degat et al. 2010; Eriksen et al. 2013; Fisher et al. 2013; Fu et al. 2014a), non-HDL cholesterol (Fisher et al. 2013), LDL cholesterol (Châtaeu-Degat et al. 2010; Fisher et al. 2013; Fu et al. 2014a; Starling et al. 2014a), HDL cholesterol (Fisher et al. 2013; Fu et al. 2014a), or triglycerides (Fu et al. 2014a; Starling et al. 2014a). Additionally, two studies did not find increased risks of elevated cholesterol levels (Fisher et al. 2013; Fu et al. 2014a). Several of these studies controlled for use of cholesterol-lowering medication (Châtaeu-Degat et al. 2010; Eriksen et al. 2013; Fisher et al. 2013; Nelson et al. 2010). Overall, studies of children and adolescents have found associations for serum lipid levels. Geiger et al. (2014b) found increases in the risk of elevated cholesterol and LDL cholesterol in children and adolescents aged 12–18 years; an association between serum PFOS and LDL cholesterol levels was also found. Zeng et al. (2015) found associations between serum PFOS and serum total cholesterol, LDL cholesterol, and triglyceride levels in children aged 12–15 years. Timmermann et al. (2014) also found an association between serum PFOS and triglycerides only in obese Danish children (8–10 years of age), but not in normal weight children. In

2. HEALTH EFFECTS

contrast, Maisonet et al. (2015b) found an inverse association between maternal serum PFOS and total cholesterol and LDL cholesterol in 15-year-old girls; no association was found when the girls were 7 years of age.

Laboratory Animal Studies. Unpublished data summarized by OECD (2002) indicate that inhalation exposure of rats to lethal concentrations (1,890–45,970 mg/m³) of PFOS dusts for 1 hour resulted in varying discoloration of the liver.

Consistent with the results for PFOA, acute-duration oral exposure of rats to PFOS resulted in increases in liver weight (Elcombe et al. 2012b; Era et al. 2009; Haughom and Spydevold 1992), hepatocellular hypertrophy (Elcombe et al. 2012b), and decreases in serum cholesterol and/or triglyceride levels (Elcombe et al. 2012a, 2012b; Haughom and Spydevold 1992). The lowest adverse effect level for increased liver weight, hypertrophy, and decreased serum cholesterol was 1.79 mg/kg/day in rats exposed to PFOS in the diet for 7 days (Elcombe et al. 2012b); however, a similar study by this group did not find significant alterations in liver weight or ALT, AST, or serum cholesterol levels after 7 days of exposure to 1.72 mg/kg/day (Elcombe et al. 2012a). Likewise, in mice, increases in liver weight (Fuentes et al. 2006; Qazi et al. 2009b, 2010a; Wan et al. 2011), hepatocellular hypertrophy (Qazi et al. 2010a), and decreases in serum cholesterol levels (Qazi et al. 2010a) were observed following acute exposure to PFOS. The lowest LOAEL for liver weight was 3 mg/kg/day in mice administered PFOS via gavage on GDs 6–18 (Fuentes et al. 2006); no effects were observed at 1.5 mg/kg/day. The only acute-duration mouse study that included histopathological examination of the liver and measurement of serum cholesterol levels identified a LOAEL of 8.5 mg/kg/day in mice exposed to PFOS in the diet for 10 days (Qazi et al. 2010a).

Intermediate-duration exposure to PFOS resulted in increased liver weight in rats (Cui et al. 2009; Curran et al. 2008; Elcombe et al. 2012a; Seacat et al. 2003; Thibodeaux et al. 2003) and mice (Bijland et al. 2011; Thibodeaux et al. 2003; Wan et al. 2011, 2014b; Xing et al. 2016; Yahia et al. 2008), hepatocellular hypertrophy in rats (Cui et al. 2009; Curran et al. 2008; Elcombe et al. 2012a; Seacat et al. 2003), decreased serum cholesterol levels in rats (Curran et al. 2008; Elcombe et al. 2012a; Luebker et al. 2005b; Seacat et al. 2003), decreased total cholesterol, triglyceride, non-HDL cholesterol, and HDL cholesterol levels in mice (Bijland et al. 2011), and increased serum AST and GGT levels in mice (Xing et al. 2016). A mouse study (Bijland et al. 2011) also showed dramatic decreases in the hepatic production of VLDL and HDL (Bijland et al. 2011). Another mouse study (Lee et al. 2015b) did not find increases in hepatic lipid levels in dams, although there were alterations in fetal livers. Only one of the intermediate-duration mouse studies included histopathological examination of the liver. Xing et al. (2016) reported

2. HEALTH EFFECTS

cytoplasmic vacuolization, focal necrosis, and hepatocellular hypertrophy in mice exposed to PFOS via gavage for 30 days; however, the study did not report incidence; the lowest dose tested was 2.5 mg/kg/day. The lowest adverse effect level for liver effects in rats was 0.14 mg/kg/day for a significant increase in relative liver weight in female rats, but not male rats, exposed to PFOS in the diet for 28 days (Curran et al. 2008). This study also found significant decreases in serum cholesterol levels and increases in absolute and relative liver weights in males and females at 2.98 mg/kg/day and hepatocellular hypertrophy at 5.89 mg/kg/day. Seacat et al. (2003) reported increases in liver weight, hepatocellular hypertrophy, and decreased serum cholesterol levels in rats following a 14-week dietary exposure to 1.33 mg/kg/day; however, no significant alterations in liver weight or liver histopathology were observed in rats exposed to 1.77 mg/kg/day PFOS in the diet for 4 weeks (Seacat et al. 2003). In contrast, Elcombe et al. (2012a) reported increases in liver weight, hepatocellular hypertrophy, and decreased serum cholesterol in rats exposed to 1.54 mg/kg/day PFOS in the diet for 28 days.

Data on the chronic toxicity of PFOS to the liver in rodents are limited to a study in rats (Butenhoff et al. 2012b; Thomford 2002b). Hepatotoxicity characterized by centrilobular hypertrophy, centrilobular eosinophilic hepatocytic granules, and centrilobular hepatocytic vacuolation was noted in rats exposed to PFOS in the diet for 2 years. Among rats sacrificed at the end of the study, significant increases in the incidence of centrilobular hepatocellular hypertrophy were observed in male and female rats exposed to ≥ 0.25 mg/kg/day (Thomford 2002b). When animals sacrificed at interim periods (14 or 52 weeks) and unscheduled deaths were included with animals sacrificed at exposure termination, the incidence of centrilobular hepatocellular hypertrophy was also increased in males exposed to 0.1 mg/kg/day. At ≥ 0.1 mg/kg/day, significant increases in the incidences of eosinophilic clear cell altered foci and cystic hepatocellular degeneration were observed in male rats. An increase in cystic degeneration was observed in male rats exposed to ≥ 0.025 mg/kg/day. However, this was mainly due to a high incidence in unscheduled deaths; among animals sacrificed at exposure termination, the incidence was only increased in males exposed to 1.04 mg/kg/day. An increased incidence of single cell necrosis was observed in males and females at 1.04 mg/kg/day (all groups combined). Observations made in a group of rats exposed to 1.17 mg/kg/day PFOS for 52 weeks and allowed to continue on the control diet for an additional year showed that hepatotoxicity was not a persistent response, as hepatotoxicity was generally absent at the end of the recovery period. At termination, electron microscopy showed mild to moderate smooth endoplasmic reticulum hyperplasia and minimal to mild hepatocellular hypertrophy primarily in rats dosed with 1.5 mg/kg/day PFOS, the highest dose tested.

2. HEALTH EFFECTS

Treatment of Cynomolgus monkeys with up to 2 mg/kg/day PFOS administered via a capsule for 4 weeks did not induce gross or microscopic morphological alterations in the liver and did not increase cell proliferation (Thomford 2002a). In a 26-week study in Cynomolgus monkeys, exposure to 0.75 mg/kg/day PFOS, administered via a capsule resulted in increased absolute liver weight after 183 days of treatment (Seacat et al. 2002). Significant decreases in serum total cholesterol were also observed at 0.75 mg/kg/day after 91, 153, and 182 days of exposure. On day 182, total cholesterol decreased to 35 and 53% of predosing values in males and females, respectively. The HDL cholesterol levels were significantly lower in males at 0.03 and 0.75 mg/kg/day on days 153 and 182 and in females at 0.15 and 0.75 mg/kg/day on days 153 and 182; the lack of pre-treatment HDL cholesterol measurements precludes within-group comparisons. Serum bilirubin was significantly lower in males at 0.75 mg/kg/day on days 91, 153, and 182. Light microscopy of liver sections showed centrilobular vacuolation, hypertrophy, and mild bile stasis in some monkeys exposed to 0.75 mg/kg/day. Electron microscopy showed lipid-droplet accumulation in some males and females exposed to 0.75 mg/kg/day. Increased glycogen content was also noted at this dose level. No histological alterations were observed in the livers of monkeys exposed to 0.75 mg/kg/day for 26 weeks and allowed to recover for 7 months or 1 year. Similarly, serum cholesterol returned to pretreatment levels 36 days post exposure and HDL cholesterol levels returned to pretreatment levels after 61 days of recovery.

Summary. Epidemiology studies have examined the possible associations between PFOS exposure and liver disease in workers and hepatocellular damage and alterations in serum lipid levels in workers and the general population. The available occupational exposure studies or general population studies do not consistently suggest an association between PFOS exposure and increases in the risk of liver disease or biliary tract disorders. A small number of occupational exposure studies have not found associations between serum PFOS levels and increases in ALT, AST, or GGT levels. Overall, the epidemiology studies suggest an association between serum PFOS levels and increases in serum total cholesterol levels and possibly serum LDL cholesterol levels. Studies of workers at a PFOS manufacturing facility found elevated serum total cholesterol levels in workers with high serum PFOS levels; however, a longitudinal analysis at the same facility did not find that serum PFOS was a significant predictor of cholesterol levels. Studies of residents living in an area with very high PFOA water levels found increases in serum total cholesterol levels associated with elevated serum PFOS levels in children, adolescents, and adults. Mixed results have been found for associations between serum PFOS and increases in serum total cholesterol levels in general population studies. Associations have been found between serum PFOS levels and serum LDL-cholesterol levels among non-occupational populations. In laboratory animals, oral exposure to PFOS results in increases in liver weight, hepatocellular hypertrophy, and decreases in serum lipid

2. HEALTH EFFECTS

levels. A small number of studies also reported focal necrosis and centrilobular hepatocytic vacuolization. The applicability of the hepatic hypertrophy and serum lipid alterations observed in rodent studies to humans has been questioned due to species differences in PPAR α receptor activation, the presumed mechanism of action for these effects in rodents.

PFHxS

Epidemiology Studies—Hepatic Serum Enzymes and Bilirubin Levels. Lin et al. (2010) did not find associations between serum ALT and GGT levels with serum PFHxS levels in a general population study using the NHANES data set.

Epidemiology Studies—Serum Lipids. Four studies have evaluated the potential association between serum PFHxS levels and serum lipids in the general population. A study utilizing the NHANES data set for adults not taking cholesterol-lowering medication reported an association between serum PFHxS and non-HDL cholesterol, but no associations with total cholesterol, LDL cholesterol, or HDL cholesterol (Nelson et al. 2010). In a study of Canadian adults not taking cholesterol-lowering medication with a geometric mean serum PFHxS level of 2.16 ng/mL, associations were found for total cholesterol, LDL cholesterol, and non-HDL cholesterol (Fisher et al. 2013). The study also found increased odds of having a high cholesterol level with increasing PFHxS levels. In pregnant women in Norway with median serum PFHxS levels of 0.60 ng/mL, serum PFHxS levels were associated with serum HDL cholesterol, but not with total cholesterol, LDL cholesterol, or triglycerides (Starling et al. 2014a). No associations between serum PFHxS and total cholesterol, LDL cholesterol, HDL cholesterol, or triglyceride levels were found in a study of Taiwanese children aged 12–15 years (mean serum PFHxS of 2.1 ng/mL) (Zeng et al. 2015).

Laboratory Animal Studies. Acute-duration gavage administration of PFHxS resulted in increases in liver weight, steatosis, and increases in hepatic triglyceride levels in mice; increases in liver weight and steatosis were also observed in similarly exposed PPAR α -null mice (Das et al. 2017). An intermediate-duration study with PFHxS in rats reported that gavage doses ≥ 3 mg/kg/day induced a significant increase in absolute and relative liver weight in males (Butenhoff et al. 2009a; Hoberman and York 2003). Light microscopy revealed minimal to moderate enlargement of centrilobular hepatocytes. Clinical chemistry tests showed a significant decrease in serum cholesterol at ≥ 0.3 mg/kg/day and decreased serum triglycerides at 10 mg/kg/day. None of these alterations were observed in female rats. In male mice, dietary exposure to PFHxS in a western-type diet resulted in $>50\%$ decreases in plasma triglyceride, total cholesterol, non-HDL cholesterol, and HDL cholesterol levels and approximately 75% decreases in the

2. HEALTH EFFECTS

hepatic production of VLDL (Bijland et al. 2011). Increases in liver weight and hepatic triglyceride levels were also observed.

PFNA

Epidemiology Studies—Hepatic Serum Enzymes and Bilirubin Levels. A health evaluation of workers at a U.S. polymer production facility using PFNA did not find alterations in ALT, AST, GGT, or bilirubin levels related to increases in exposure intensity score in a longitudinal analysis (Mundt et al. 2007). Associations between serum PFNA and ALT and GGT levels were observed in a NHANES data study (Gleason et al. 2015); however, another study (Lin et al. 2010) utilizing the NHANES data did not find associations between serum PFNA and these enzymes. Neither study found associations for AST or total bilirubin. The Gleason et al. (2015) study also did not find increased risks for elevated ALT, AST, GGT, or bilirubin.

Epidemiology Studies—Serum Lipids. Longitudinal analysis of serum lipid levels in the occupational exposure study (Mundt et al. 2007) did not find significant differences in serum total cholesterol or triglycerides over time. In general population studies, associations have been observed between serum PFNA levels and total cholesterol levels in adults (Fu et al. 2014a; Nelson et al. 2010) and children (Zeng et al. 2015); one study in pregnant women did not find an association (Starling et al. 2014a). Several studies have also found associations with LDL cholesterol (Fu et al. 2014a; Zeng et al. 2015) or non-HDL cholesterol (Nelson et al. 2010), but others did not find associations for LDL cholesterol (Nelson et al. 2010; Starling et al. 2014a). Most studies did not find an association between serum PFNA and HDL cholesterol (Fu et al. 2014a; Nelson et al. 2010; Zeng et al. 2015) or triglycerides (Fu et al. 2014a; Starling et al. 2014a). Exceptions were the Starling et al. (2014a) study of pregnant women, which found a positive association for HDL cholesterol, and Zeng et al. (2015), which found an association with triglycerides in children. Fu et al. (2014a) did not find increased risks of elevated cholesterol, LDL cholesterol, or triglyceride levels or lowered HDL cholesterol levels in adults.

Laboratory Animal Studies. Nine studies have evaluated the hepatic toxicity of PFNA. The observed effects are consistent with effects observed for other perfluoroalkyl compounds. Alterations in serum lipid levels consisted of decreases in serum HDL cholesterol levels in rats administered via gavage ≥ 1 mg/kg/day for 14 days (Fang et al. 2012a) and decreases in serum triglyceride and cholesterol levels in mice receiving gavage doses of ≥ 1 mg/kg/day (Wang et al. 2015a). Increases in liver weight were observed in rats nose-only exposed to ≥ 67 mg/m³ (Kinney et al. 1989), in mice administered via gavage

2. HEALTH EFFECTS

10 mg/kg/day PFNA for 7 days (Das et al. 2017), in mice exposed to 0.5 mg/kg/day PFNA in the diet for 14 days (Kennedy 1987), in mice administered ≥ 0.2 mg/kg/day PFNA via gavage for 14 days (Wang et al. 2015a), and in the offspring of mice administered via gavage ≥ 0.83 mg/kg/day PFNA on GDs 1–17 or 1–18 (Das et al. 2015; Wolf et al. 2010). Hepatocellular vacuolation was observed in mice administered via gavage 5 mg/kg/day for 14 days (Fang et al. 2012b). In PPAR α -null mice, increases in liver weight were observed in non-pregnant mice administered via gavage ≥ 1.5 mg/kg/day for 18 days, but were not found in pregnant animals (Wolf et al. 2010). Das et al. (2017) found increases in liver weight, steatosis, and increases in liver triglyceride levels in PPAR α -null mice administered 10 mg/kg/day for 10 days.

PFDeA

Epidemiology Studies—Serum Lipids. Three general population studies have evaluated the potential relationships between serum PFDeA and serum lipids and reported inconsistent results. Fu et al. (2014a) found an association between serum PFDeA and total cholesterol in adults; studies in pregnant women (Starling et al. 2014a) and children (Zeng et al. 2015) did not find associations. Both Fu et al. (2014a) and Starling et al. (2014a) found positive associations with HDL cholesterol; this was not found in the Zeng et al. (2015) study. None of the studies found associations between serum PFDeA and LDL cholesterol or triglycerides (Fu et al. 2014a; Starling et al. 2014a; Zeng et al. 2015). Only the Fu et al. (2014a) study looked for alterations in the risk of elevated cholesterol, LDL cholesterol, or triglyceride levels or decreased HDL cholesterol levels, but the study did not find significant increases in the risk.

Laboratory Animal Studies. Hepatic effects observed in laboratory animals exposed to PFDeA include alterations in liver weight and morphology. Increases in liver weight have been observed in mice following a single gavage dose of PFDeA; the alterations were observed 2 days after exposure to 40 mg/kg/day (Brewster and Birnbaum 1989) or 30 days after exposure to ≥ 20 mg/kg/day (Harris et al. 1989). Repeated dietary exposure to 2.4 mg/kg/day PFDeA for 1 week (Kawashima et al. 1995) or 78 mg/kg/day for 10 days (Permadi et al. 1992, 1993) also resulted in increases in liver weight. Oral doses ≥ 9.5 mg/kg/day also resulted in increases in hepatic cholesterol levels in rats (Kawashima et al. 1995) and hepatic lipids in mice (Brewster and Birnbaum 1989). These acute doses were also associated with hepatocellular hypertrophy and evidence of peroxisome proliferation. Thirty days after a single gavage dose of ≥ 20 mg/kg/day PFDeA, effects included periportal to panlobular hepatocellular hypertrophy characterized by swollen hepatocytes with abundant granular eosinophilic cytoplasm and enlarged and hyperchromatic nuclei (Harris et al. 1989).

2. HEALTH EFFECTS

PFUA

Epidemiology Studies—Serum Lipids. Neither of the two studies (Fu et al. 2014a; Starling et al. 2014a) examining possible relationships between serum PFUA and serum lipids found associations between serum PFUA and for total cholesterol, LDL cholesterol, or triglyceride levels. Starling et al. (2014a) found an association of serum PFUA levels with HDL cholesterol levels; Fu et al. (2014a) did not find an association for this parameter. No alterations in the risk of abnormal serum lipid levels were found in the adults examined by Fu et al. (2014a).

Laboratory Animal Studies. Only one animal study was identified that examined the liver following oral exposure to PFUA. In an intermediate-duration study of rats administered PFUA via gavage, increases in relative liver weight were observed in males at 0.3 mg/kg/day and in females at 1.0 mg/kg/day, and mild to moderate centrilobular hepatocellular hypertrophy was observed in males and females at 1.0 mg/kg/day (Takahashi et al. 2014).

PFHpA

Epidemiology Studies—Serum Lipids. Epidemiology data on PFHpA are limited to a study in adults conducted by Fu et al. (2014a), which found no associations between serum PFHpA and total cholesterol, LDL cholesterol, HDL cholesterol, or triglyceride levels.

PFBuS

Epidemiology Studies—Serum Lipids. In the only epidemiology study examining serum lipids and possible associations with serum PFBuS, Zeng et al. (2015) found an association with total cholesterol levels in children. No associations were found between serum PFBuS and LDL cholesterol, HDL cholesterol, or triglycerides.

Laboratory Animal Studies. Treatment of male rats with 900 mg/kg/day PFBuS by gavage for 28 days induced a significant increase in absolute and relative liver weight (25–30%) relative to controls, which was no longer detected following a 14-day recovery period (3M 2001). Clinical chemistry tests of liver function were unremarkable and there were no chemical-related microscopic alterations. The NOAEL for liver weight effects was 300 mg/kg/day. No alterations in liver weight, serum chemistry parameters (ALT, AST, cholesterol), or liver morphology were observed in rats administered gavage doses as high as

2. HEALTH EFFECTS

600 mg/kg/day PFBuS for 90 days (Lieder et al. 2009a). Significant increases in liver weight were observed at 300 and 1,000 mg/kg/day in a 2-generation study (Lieder et al. 2009b); the alterations were only observed in male rats. An increase in hepatocellular hypertrophy was also observed in the male P0 and F1 rats administered via gavage 1,000 mg/kg/day. Dietary exposure to mice resulted in decreases in plasma triglyceride levels and hepatic cholesterol levels, but no alterations in liver weight or plasma cholesterol, HDL cholesterol, or non-HDL cholesterol (Bijland et al. 2011).

PFBA

Epidemiology Studies—Serum Lipids. Only one epidemiology study examined hepatic outcomes; this study (Fu et al. 2014a) did not find any associations between serum PFBA levels and total cholesterol, LDL cholesterol, HDL cholesterol, or triglycerides in adults.

Laboratory Animal Studies. Treatment of rats with up to 184 mg/kg/day PFBA by gavage for 5 days did not affect liver weight, nor did it cause gross or microscopic morphological alterations in the liver (3M 2007a). In addition, clinical chemistry tests did not indicate altered liver function. Similarly, administration of approximately 20 mg/kg/day PFBA in the diet to male rats for 2 weeks did not significantly affect relative liver weight, but the same dose of PFOA induced a 45% increase in liver weight (Ikeda et al. 1985). Dietary administration of doses of approximately 78 mg/kg/day PFBA to male mice for 10 days induced a 63% increase in absolute liver weight (Permadi et al. 1992, 1993).

PFBA intermediate-duration studies have consistently found increases in liver weight and histological alterations. Dosing rats with by gavage for 28 days resulted in significant increases in absolute and relative liver weight and decreases in serum cholesterol at ≥ 30 mg/kg/day and hepatocellular hypertrophy at 150 mg/kg/day (Butenhoff et al. 2012a; van Otterdijk 2007a). Administration of 150 mg/kg/day induced hepatocyte hypertrophy. These liver effects were no longer detected after a 21-day recovery period. In a similar 90-day study, administration of 30 mg/kg/day resulted in increased absolute liver weight and panlobular hepatocyte hypertrophy (Butenhoff et al. 2012a; van Otterdijk 2007b); no liver effects were observed at 6 mg/kg/day. None of the liver alterations were observed after a 21-day recovery period.

2. HEALTH EFFECTS

PFD_oA

Epidemiology Studies—Serum Lipids. A general population study of adolescents (Zeng et al. 2015) did not find any associations between serum PFD_oA and total cholesterol, LDL cholesterol, HDL cholesterol, or triglyceride levels.

Laboratory Animal Studies. Dosing of male Sprague-Dawley rats with 10 mg/kg/day PFD_oA by gavage for 14 days induced a 35% increase in total serum cholesterol; doses of 1 or 5 mg/kg/day had no significant effect (Shi et al. 2007). In a subsequent study, the same group of investigators reported that in rats dosed via gavage with 1 or 5 mg/kg/day PFD_oA, there was a trend for decreased serum triglycerides, but the differences with controls were not statistically significant (Zhang et al. 2008); at 10 mg/kg/day, serum triglyceride levels were significantly increased. Liver triglyceride and liver cholesterol levels were increased at ≥ 5 mg/kg/day. Single doses ≥ 1 mg/kg/day significantly induced the expression of PPAR α and PPAR γ and their target genes to enhance fatty acid β -oxidation. Absolute liver weight was significantly reduced in the 5 mg/kg/day group (19%) relative to controls, but this may have been due to a marked reduction in body weight (shown in Shi et al. [2007], but not in Zhang et al. [2008]).

PFHxA

Laboratory Animal Studies. In a chronic-duration study, gavage administration of 200 mg/kg/day for 2 years resulted in increases in the incidence of hepatocellular necrosis in female rats (Klaunig et al. 2015). At 100 mg/kg/day, decreases in triglyceride levels were observed in male rats.

PFOSA

Laboratory Animal Studies. In the only study examining hepatic effects, Seacat and Luebker (2000) reported no alterations in liver weight in rats receiving a single gavage dose of 5 mg/kg PFOSA.

2.10 RENAL

Overview. Epidemiology and laboratory animal studies have evaluated the potential of perfluoroalkyls to be renal toxicants. Human studies have evaluated the risk of kidney disease, alterations in renal function, damage to the kidney, and alterations in uric acid levels. The results of epidemiology studies evaluating kidney disease and renal function are summarized in Table 2-13; Table 2-14 contains the studies

2. HEALTH EFFECTS

Table 2-13. Summary of Renal Outcomes in Humans^a

Reference and study population ^b	Serum perfluoroalkyl level	Outcome evaluated	Result ^c
PFOA			
Costa et al. 2009 Occupational (n =53)	12,930 ng/mL (mean PFOA in current workers)	Serum urea	NS (p>0.05)
		Serum creatinine	NS (p>0.05)
		Total proteins	NS (p>0.05)
		α1 globulins, α2 globulins, β globulins, or γ globulins	NS (p>0.05)
		α2 globulins	Association (p<0.01), current, former and non-exposed workers.
Lundin et al. 2009 Occupational (n=3,992)	NR	Nephritis and nephrosis deaths	SMR 5.2 (0.6–18.9)
Raleigh et al. 2014 Occupational (n=9,027)	NR	Chronic kidney disease deaths	HR 0.73 (0.21–2.48), 4 th quartile
Steenland et al. 2015 Occupational (n=3,713)	Cumulative PFOA	Chronic kidney disease risk	NS (p=0.92), no lag NS (p=0.99), 10-year lag
Steenland and Woskie 2012 Occupational (n=1,084)	7,800 ng/mL-year (mean PFOA)	Chronic kidney disease deaths	SMR 3.79 (1.03–9.71)*, 2nd quartile
Anderson-Mahoney et al. 2008 Community (n=566)	NR	Kidney disease (self- reported)	SPR 2.26 (1.45–3.51)*
Dhingra et al. 2016b Community (C8) (n=28,541)	Cumulative PFOA	Chronic kidney disease	NS (p=0.80 for trend), no lag NS (p=0.81 for trend), 5-year lag NS (p=0.88 for trend), 10-year lag NS (p=0.30 for trend), 20-year lag
Emmett et al. 2006b Community (n=371)	354 ng/mL (median PFOA)	Serum creatinine	NS (p>0.05)
		BUN	NS (p>0.05)
		Total serum proteins	NS (p>0.05)

2. HEALTH EFFECTS

Table 2-13. Summary of Renal Outcomes in Humans^a

Reference and study population ^b	Serum perfluoroalkyl level	Outcome evaluated	Result ^c
Watkins et al. 2013 Community (C8) (9,660 children)	28.3 ng/mL (median PFOA)	GFR	Inverse association (p=0.02)*
Kataria et al. 2015 General population (NHANES) (n=1,960 adolescents)	≥4.7 ng/mL (4 th PFOA quartile)	GFR	Inverse association (p<0.01)*, 4th quartile
		Serum uric acid	Association (p<0.01)*
Shankar et al. 2011a General population (NHANES) (n=4,587)	>5.9 ng/mL (4 th PFOA quartile)	GFR	Inverse association (p<0.001 for trend)*
		Chronic kidney disease	OR 1.73 (1.04–2.88)*, 4th quartile
PFOS			
Olsen et al. 1998a Occupational (n=178 in 1995; n=149 in 1997)	2,440 and 1,930 ng/mL (mean PFOS in 1995 in DeCatur and Antwerp) 1,960 and 1,480 ng/mL (mean in 1997 in DeCatur and Antwerp)	Serum creatinine BUN	Association (p<0.06)*, 1997 only NS (p>0.1)
Watkins et al. 2013 Community (C8) (9,660 children)	20.0 ng/mL (median PFOS)	GFR	Inverse association (p=0.0001)*
Kataria et al. 2015 General population (NHANES) (n=1,960 adolescents)	7.9–12.8 ng/mL (2 nd PFOS quartile) ≥19.4 ng/mL (4 th PFOS quartile)	GFR	Inverse association (p<0.05)*, 2nd quartile
Shankar et al. 2011a General population (NHANES) (n=4,587)	>29.5 ng/mL (4 th PFOS quartile) 11.2–17.8 ng/mL (2 nd PFOS quartile)	GFR	Inverse association (p<0.001 for trend)*
		Chronic kidney disease	OR 1.82 (1.02–3.27)*, 4th quartile
PFHxS			
Watkins et al. 2013 Community (C8) (9,660 children)	5.2 ng/mL (median PFHxS)	GFR	Inverse association (p=0.003)*

2. HEALTH EFFECTS

Table 2-13. Summary of Renal Outcomes in Humans^a

Reference and study population ^b	Serum perfluoroalkyl level	Outcome evaluated	Result ^c
Kataria et al. 2015 General population (NHANES) (n=1,960 adolescents)	≥4 ng/mL (4 th PFHxS quartile)	GFR	NS (p>0.05)
PFNA			
Mundt et al. 2007 Occupational (n=592)	NR	BUN Creatinine	Small, but not clinically significant
Watkins et al. 2013 Community (C8) (9,660 children)	1.5 ng/mL (median PFNA)	GFR	Inverse association (p=0.002)*
Kataria et al. 2015 General population (NHANES) (n=1,960 adolescents)	≥1.5 ng/mL (4 th PFNA quartile)	GFR	NS (p>0.05)

^aSee the *Supporting Document for Epidemiological Studies for Perfluoroalkyls*, Table 8 for more detailed descriptions of studies.

^bParticipants in occupational exposure may have also lived near the site and received residential exposure; community exposure studies involved subjects living near PFOA facilities with known exposure to high levels of PFOA.

^cAsterisk indicates association with perfluoroalkyl compound; unless otherwise specified, values in parenthesis are 95% confidence intervals.

BUN = blood urea nitrogen; GFR = glomerular filtration rate; HR = hazard ratio; NHANES = National Health and Nutrition Examination Survey; NR = not reported; NS = not significant; OR = odds ratio; PFHxS = perfluorohexane sulfonic acid; PFNA = perfluorononanoic acid; PFOA = perfluorooctanoic acid; PFOS = perfluorooctane sulfonic acid; SMR = standardized mortality ratio

2. HEALTH EFFECTS

Table 2-14. Summary of Uric Acid Outcomes in Humans^a

Reference and study population ^b	Serum perfluoroalkyl level	Outcome evaluated	Result ^c
PFOA			
Costa et al. 2009 Occupational (n=53)	12,930, ng/mL (mean PFOA in current workers)	Serum uric acid	Association (p=0.039)*
Sakr et al. 2007b Occupational (n=1,025)	490 ng/mL (median PFOA)	Serum uric acid	Association (reported by investigator)*
Steenland et al. 2010b Community (n=54,591)	11.5–20.6 ng/mL (2 nd quintile PFOA)	Hyperuricemia risk	OR 1.33 (1.24–1.43)* (2nd quintile)
Gleason et al. 2015 General population (NHANES) (n=4,333 adolescents)	3.7 ng/mL (median PFOA)	Serum uric acid Hyperuricemia risk	Association (p<0.001)* Association (p<0.001)*
Geiger et al. 2013 General population (NHANES) (n=1,772 adolescents and adults)	4.3 ng/mL (mean PFOA), >5.4 ng/mL (4 th PFOA quartile)	Serum uric acid Hyperuricemia risk	Association (p=0.0001)* OR 1.62 (1.10–2.37)* (4th quartile)
Kataria et al. 2015 General population (NHANES) (n=1,960 adolescents)	≥4.7 ng/mL (4 th PFOA quartile)	Serum uric acid	Association (p<0.01)*
Qin et al. 2016 General population (n=225 adolescents)	0.5 ng/mL (median PFOA)	Serum uric acid Hyperuricemia risk	Association (p<0.05)* OR 2.16 (1.29–3.61)* (full cohort) OR 2.76 (1.37–5.56)* (boys only)
Shankar et al. 2011b General population (NHANES) (n=3,883 adults)	3.5–5.1 ng/mL (3 rd PFOA quartile)	Serum uric acid Hyperuricemia risk	Association (p<0.0001)* OR 1.90 (1.35–2.69)*, 3rd quartile
PFOS			
Steenland et al. 2010b Community (n=54,591)	17.5–23,26 ng/mL (3 rd PFOS quintile)	Hyperuricemia risk	OR 1.11 (1.04–1.20)* (3rd quintile)

2. HEALTH EFFECTS

Table 2-14. Summary of Uric Acid Outcomes in Humans^a

Reference and study population ^b	Serum perfluoroalkyl level	Outcome evaluated	Result ^c
Gleason et al. 2015 General population (NHANES, n=4,333 adolescents)	11.3 ng/mL (median PFOS)	Serum uric acid	Association (p<0.01)*
		Hyperuricemia risk	NS (p=0.502)
Geiger et al. 2013 General population (NHANES) (n=1,772 adolescents and adults)	18.4 ng/mL (mean PFOS), >25.5 ng/mL (4 th PFOS quartile)	Serum uric acid	NS (p=0.0575)
		Hyperuricemia risk	OR 1.65 (1.10–2.49)* (4th quartile)
Kataria et al. 2015 General population (NHANES) (n=1,960 adolescents)	≥19.4 ng/mL (4 th PFOS quartile)	Serum uric acid	Association (p<0.05)*
Qin et al. 2016 General population (n=225 adolescents)	28.9 ng/mL (median PFOS)	Serum uric acid	NS (p>0.05)
		Hyperuricemia risk	OR 1.35 (0.95–1.93) (full cohort)
Shankar et al. 2011b General population (NHANES) (n=3,883 adults)	11.2–17.8 ng/mL (2 nd PFOS quartile)	Serum uric acid	Association (p=0.0018)*
		Hyperuricemia risk	OR 1.46 (1.11–1.91)*, 2nd quartile
PFHxS			
Gleason et al. 2015 General population (NHANES) (n=4,333)	1.8 ng/mL (median PFHxS)	Serum uric acid	NS (p>0.01)
		Hyperuricemia risk	NS (p=0.110 for trend)
Kataria et al. 2015 General population (NHANES) (n=1,960 adolescents)	≥4 ng/mL (4 th PFHxS quartile)	Serum uric acid	NS (p>0.05)
Qin et al. 2016 General population (n=225 adolescents)	1.3 ng/mL (median PFHxS)	Serum uric acid	Association (p<0.05)*
		Hyperuricemia risk	OR 1.39 (0.93–2.07)
PFNA			
Mundt et al. 2007 Occupational (n=592)	NR	Serum uric acid	Small, but not clinically significant

2. HEALTH EFFECTS

Table 2-14. Summary of Uric Acid Outcomes in Humans^a

Reference and study population ^b	Serum perfluoroalkyl level	Outcome evaluated	Result ^c
Gleason et al. 2015	1.4 ng/mL (median PFNA)	Serum uric acid	Association (p<0.001)*
General population (NHANES) (n=4,333)		Hyperuricemia risk	NS (p=0.42 for trend)
Kataria et al. 2015	≥1.5 ng/mL (4 th PFNA quartile)	Serum uric acid	NS (p>0.05)
General population (NHANES) (n=1,960 adolescents)			
Qin et al. 2016	0.8 ng/mL (median PFNA)	Serum uric acid	NS (p>0.05)
General population (n=225 adolescents)		Hyperuricemia risk	OR 1.28 (0.83–1.96)
PFDeA			
Qin et al. 2016	0.9 ng/mL (median PFDeA)	Serum uric acid	NS (p>0.05)
General population (n=225 adolescents)		Hyperuricemia risk	OR 1.26 (0.82–1.92)
PFBuS			
Qin et al. 2016	0.5 ng/mL (median PFBuS)	Serum uric acid	NS (p>0.05)
General population (n=225 adolescents)		Hyperuricemia risk	OR 1.23 (0.86–1.75)
PFDoA			
Qin et al. 2016	2.7 ng/mL (median PFDoA)	Serum uric acid	NS (p>0.05)
General population (n=225 adolescents)		Hyperuricemia risk	OR 0.93 (0.65–1.34)

2. HEALTH EFFECTS

Table 2-14. Summary of Uric Acid Outcomes in Humans^a

Reference and study population ^b	Serum perfluoroalkyl level	Outcome evaluated	Result ^c
PFHxA			
Qin et al. 2016	0.2 ng/mL (median PFHxA)	Serum uric acid	NS (p>0.05)
General population (n=225 adolescents)		Hyperuricemia risk	OR 1.08 (0.77–1.61)

^aSee the *Supporting Document for Epidemiological Studies for Perfluoroalkyls*, Table 8 for more detailed descriptions of studies.

^bParticipants in occupational exposure may have also lived near the site and received residential exposure; community exposure studies involved subjects living near PFOA facilities with known exposure to high levels of PFOA.

^cAsterisk indicates association with perfluoroalkyl compound; unless otherwise specified, values in parenthesis are 95% confidence intervals.

NHANES = National Health and Nutrition Examination Survey; NR = not reported; NS = not significant; OR = odds ratio; PFBuS = perfluorobutane sulfonic acid; PFDoA = perfluorododecanoic acid; PFHxS = perfluorohexane sulfonic acid; PFNA = perfluorononanoic acid; PFOA = perfluorooctanoic acid; PFOS = perfluorooctane sulfonic acid

2. HEALTH EFFECTS

evaluating alterations in uric acid levels. More detailed descriptions of these studies can be found in the *Supporting Document for Epidemiological Studies for Perfluoroalkyls*, Table 8. Although there are a couple of studies finding associations between PFOA exposure and kidney disease, the results are not consistent across study populations. However, there is some indication that perfluoroalkyls may affect renal function. Decreases in estimated glomerular filtration rate and increases in uric acid levels associated with serum PFOA or PFOS have been reported in a number of epidemiology studies. However, these alterations may be due to reverse causality (i.e., increases in serum perfluoroalkyl levels could be due to a decrease in glomerular filtration and shared renal transporters for perfluoroalkyls and uric acid). Based on the small number of epidemiology studies or the inconsistency of the results, possible associations between other perfluoroalkyls (PFHxS, PFNA, PFDeA, PFBuS, or PFDoA) and renal functions cannot be assessed.

Laboratory animal studies have primarily evaluated kidney morphology; these studies are summarized in Tables 2-1, 2-3, 2-4, 2-5, and 2-6. The NOAEL and LOAEL values for these studies are illustrated in Figures 2-4, 2-6, 2-7, and 2-8. In general, the laboratory animal studies have not found evidence of impaired renal function or morphological damage following exposure to PFOA, PFOS, PFHxS, PFDeA, PFUA, PFBuS, PFBA, or PFHxA.

PFOA

Epidemiology Studies—Kidney Disease. Several epidemiology studies have examined the possible association between PFOA exposure and increased risk of kidney disease. In a cohort mortality study of workers at the DuPont PFOA facility in West Virginia, Steenland and Woskie (2012) found an increase in deaths from chronic renal disease when compared to DuPont workers at other regional facilities. When cumulative PFOA exposure was estimated based on the worker's job history and data from a biomonitoring survey conducted from 1979 to 2004, there was a significant positive trend for nonmalignant kidney disease when the workers were divided in estimated cumulative exposure quartiles. Two studies of workers at the 3M APFO facility in Cottage Grove, Minnesota did not find increases in deaths from chronic kidney disease (Raleigh et al. 2014) or nephritis and nephrosis (Lundin et al. 2009) as compared to mortality rates for the state of Minnesota. Similar results were found when chronic kidney disease deaths were compared to those in cohort of workers in St. Paul Minnesota who worked at a non-APFO facility (Raleigh et al. 2014). An occupational exposure study (Steenland et al. 2015) and C8 community study (Dhingra et al. 2016b) found no associations between cumulative PFOA exposure and the risk of chronic kidney disease. Another study of the community living near the Washington Works

2. HEALTH EFFECTS

facility found a higher prevalence of self-reported kidney disease as compared to rates reported in NHANES (Anderson-Mahoney et al. 2008).

Epidemiology Studies—Biomarkers of Renal Function. Several biomarkers of renal function have been evaluated in epidemiology studies; these include BUN, serum creatinine, glomerular filtration rate, and uric acid levels (discussed in the following section). Kidney function, assessed by levels of BUN and serum creatinine, was not associated with exposure to PFOA in the occupational exposure studies by Olsen et al. (2003a) or Costa et al. (2009) or a community exposure study by Emmett et al. (2006b).

Three studies have found inverse associations between serum PFOA and glomerular filtration rate. Using the NHANES data for the 1999–2008 cycles, Shankar et al. (2011a) found an inverse association between serum PFOA levels and estimated glomerular filtration rate in adults. The likelihood of chronic kidney disease, defined as a glomerular filtration rate of <60 mL/minute/1.73 m², was significantly higher in adults with the highest serum PFOA (>5.9 ng/mL, OR 1.73, 95% CI 1.04–2.88) levels than in adults with serum PFOA levels in the lowest quartile. The study also investigated whether the association between serum PFOA levels and chronic kidney disease was due to reverse causality (i.e., decreased glomerular filtration leads to a decrease in perfluoroalkyl filtration) and found a stronger negative correlation between estimated glomerular filtration rate and serum PFOA levels in subjects without chronic kidney disease, suggesting that it was not due to reverse causality. In another study utilizing NHANES data, an inverse association was found in adolescents with serum PFOA levels in the 4th quartile (Kataria et al. 2015). Similarly, an inverse association between serum PFOA and glomerular filtration rate was found in children participating in the C8 Health Project (Watkins et al. 2013). Unlike Shankar et al. (2011a), Watkins et al. (2013) suggested that the association between serum perfluoroalkyl levels and estimated glomerular filtration rates may be a consequence of reverse causation because no associations were found between estimated serum PFOA levels 3 or 10 years prior to enrollment in the study or at the time of study enrollment and estimated glomerular filtration rates; predicted serum PFOA levels were based on environmental PFOA levels, self-reported residential history, and PBPK modeling.

Epidemiology Studies—Alterations in Uric Acid Levels. Associations between serum PFOA levels and serum uric acid levels have been found in several occupational, community, and general population studies. Costa et al. (2009) and Sakr et al. (2007b) reported associations between serum PFOA levels and serum uric acid levels in workers with high serum PFOA levels. In adult participants of the C8 Health Project, positive linear trends between serum uric acid levels and serum PFOA levels were found (Steenland et al. 2010b). When the subjects were categorized by PFOA levels, significantly increased

2. HEALTH EFFECTS

risks of hyperuricemia (>6.0 mg/dL for women, >6.8 mg/dL for men) were observed for subjects with serum PFOA levels in the 2nd, 3rd, 4th, and 5th quintiles (≥ 11.5 ng/mL). Four studies utilizing NHANES data have found associations between serum PFOA and serum uric acid levels in adults (Gleason et al. 2015; Shankar et al. 2011b) and adolescents (Geiger et al. 2013; Kataria et al. 2015). A study in Taiwanese adolescents also found this association between PFOA and uric acid (Qin et al. 2016). Several studies have also found increases in the risk of hyperuricemia in a highly exposed population (Steenland et al. 2010b) and the general population (Gleason et al. 2015; Geiger et al. 2013; Qin et al. 2016; Shankar et al. 2011b). The ORs for the risk of hyperuricemia in these studies are summarized in Figure 2-17.

Laboratory Animal Studies. No gross or microscopic alterations were observed in the kidneys from male rats following head-only inhalation exposure to up to 84 mg/m³ APFO dusts for 2 weeks (Kennedy et al. 1986). Significantly elevated absolute and relative kidney weight was reported in male rats dosed with ≥ 3 mg/kg/day PFOA by gavage in water for 70 days (Butenhoff et al. 2004b), but histological evaluation of the kidney was not conducted in this study. Rats that received much higher doses (100–110 mg/kg/day) of APFO for 90 days in the diet showed no significant morphological alterations in the kidneys, and BUN and the urinalysis were unremarkable (Griffith and Long 1980). Also, male mice dosed with up to 47 mg/kg/day APFO in the drinking water for 21 days showed no morphological alterations in the kidneys, and BUN and serum creatinine levels were not significantly affected (Son et al. 2008). Treatment of Cynomolgus monkeys with daily doses of up to 20 mg/kg/day APFO, administered via a capsule, for 26 weeks (Butenhoff et al. 2002) or Rhesus monkeys dosed with up to 10 mg/kg/day by gavage for 90 days (Griffith and Long 1980) did not cause morphological alterations in the kidneys, and blood chemistries and urinalyses provided no evidence of alterations in kidney function. In a 2-year dietary study in rats, relative kidney weight from males dosed with 15 mg/kg/day APFO was significantly elevated (14%) at the 1-year interim evaluation relative to controls, but gross and microscopic appearance (at 1 year and at termination), BUN, and urinalyses (several times during the study) were not significantly affected (3M 1983). No gross or microscopic alterations were seen in the kidneys from rats that received dermal applications of up to 2,000 mg/kg/day APFO to the shaven skin for 2 weeks (Kennedy 1985).

Summary. Epidemiology studies have examined possible associations between exposure to PFOA and increases in the risk of kidney disease and alterations in renal function. Mixed results for associations between serum PFOA and risks of kidney disease have been reported in occupational exposure studies and studies of highly exposed residents with more studies not finding associations. Several general population and community studies have found inverse associations between serum PFOA and

2. HEALTH EFFECTS

Figure 2-17. Risk of Hyperuricemia Relative to PFOA Levels (Presented as Adjusted Odds Ratios)

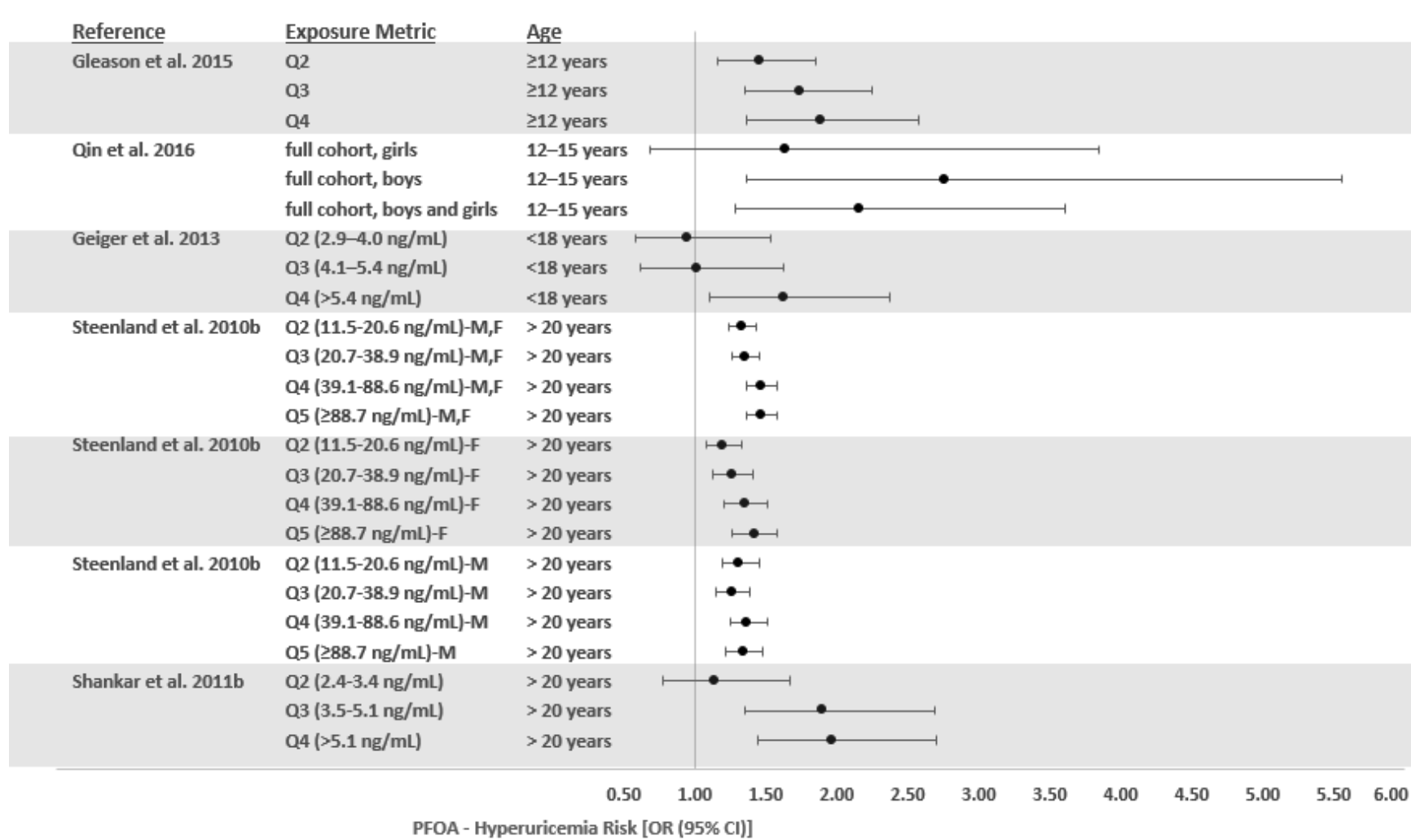

2. HEALTH EFFECTS

glomerular filtration rate; however, there is suggestive evidence that this association may be due to reverse causation rather than a direct effect. Associations between serum PFOA levels and serum uric acid levels have been consistently observed in occupational, community, and general populations. Laboratory animal studies have not found evidence of alterations in renal function or histological alterations.

PFOS

Epidemiology Studies—Biomarkers of Renal Function. Three studies have found inverse associations between serum PFOS levels and glomerular filtration rate in adults (Shankar et al. 2011a), adolescents (Kataria et al. 2015), and children (Watkins et al. 2013). In the Watkins et al. (2013) study of C8 Health Project participants, a concentration-related linear trend between decreasing estimated glomerular filtration rates and increases in serum PFOS levels was observed in children and adolescents 1–<18 years old. In adolescents 12–19 years of age participating in NHANES, the estimated glomerular filtration rate was lower in participants with serum PFOA levels in the 2nd, 3rd, and 4th quartiles than those with levels in the 1st quartile (Kataria et al. 2015). In addition to the inverse association between serum PFOS and estimated glomerular filtration rate observed in adult NHANES participants, Shankar et al. (2011a) also found increased risks of chronic kidney disease (defined as a glomerular filtration rate of <60 mL/minute/1.73 m²) in participants with serum PFOS levels in the 4th quartile.

Epidemiology Studies—Alterations in Uric Acid Levels. In a study of C8 Health Project participants, a linear trend between serum uric acid levels and serum PFOS levels was found (Steenland et al. 2010b). When the subjects were categorized by serum PFOS levels, increased risks of hyperuricemia (>6.0 mg/dL for women, >6.8 mg/dL for men) were observed for subjects with serum PFOS levels in the 3rd, 4th, and 5th quintiles. Similar findings were found in NHANES adult participants (Shankar et al. 2011b). Two studies of adolescent NHANES participants also found associations between serum PFOS and serum uric acid levels (Gleason et al. 2015; Kataria et al. 2015); a third study did not find an association (Geiger et al. 2013). The Geiger et al. (2013) study did find an increased risk of hyperuricemia for adolescents with serum PFOS levels in the 4th quartile; this was not found in the Gleason et al. (2015) study. A study of Taiwanese adolescents did not find associations between serum PFOS and uric acid or an increased risk of hyperuricemia (Qin et al. 2016). The ORs for the risk of hyperuricemia in these studies are summarized in Figure 2-18.

2. HEALTH EFFECTS

Figure 2-18. Risk of Hyperuricemia Relative to PFOS Levels (Presented as Adjusted Odds Ratios)

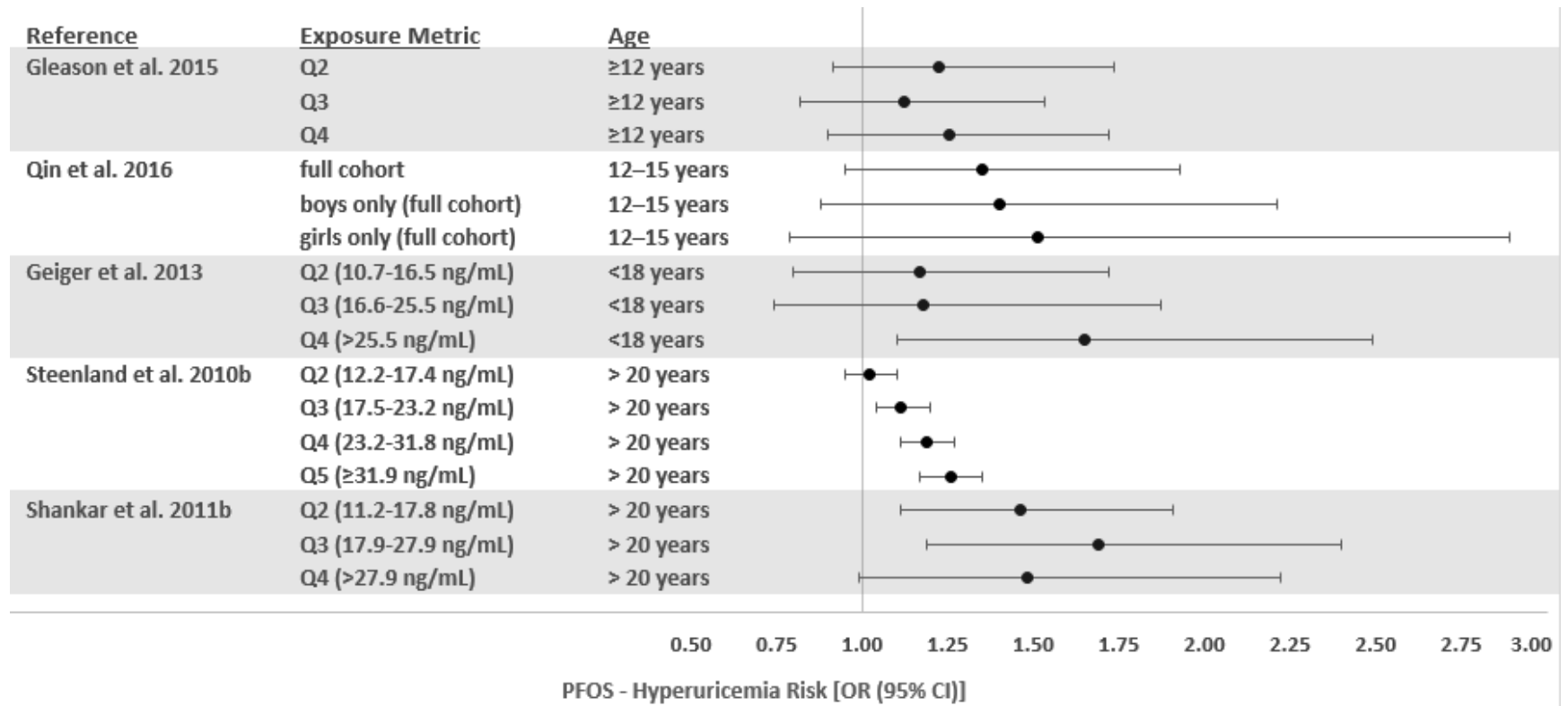

2. HEALTH EFFECTS

Laboratory Animal Studies. No significant morphological alterations or clinical evidence of impaired kidney function was reported in male and female rats dosed with up to 1.77 mg/kg/day PFOS (potassium salt) (Seacat et al. 2003) or 5.89 mg/kg/day (Curran et al. 2008) for 4 weeks. Extending the treatment to 14 weeks resulted in an increase in BUN in male (23% increase) and female rats (41% increase), but histopathology of the kidneys and urinalyses were unremarkable (Seacat et al. 2003). The NOAEL values were 0.34 and 0.4 mg/kg/day in males and females, respectively. Treatment of Cynomolgus monkeys with up to 0.75 mg/kg/day PFOS (potassium salt) administered via a capsule for 26 weeks did not cause morphological alterations in the kidneys, nor did it affect BUN, serum creatinine, or urinary parameters (Seacat et al. 2002). Similar results were reported in a 4-week study in monkeys dosed with up to 2 mg/kg/day PFOS (Thomford 2002a). A mild increase in BUN was reported in rats treated with approximately 0.25 or 1.04 mg/kg/day PFOS in the diet for 53 weeks in a 2-year study (Butenhoff et al. 2012b; Thomford 2002b). However, there were no significant gross or microscopic alterations in the kidneys at week 53 or at termination.

PFHxS

Epidemiology Studies—Biomarkers of Renal Function. A small number of epidemiology studies have evaluated biomarkers of renal function. In a study of C8 Health Project participants, an inverse association between serum PFHxS and estimated glomerular filtration rate was observed (Watkins et al. 2013). A study of adolescent participants in NHANES did not find this association (Kataria et al. 2015). A comparison between the reported median PFHxS level in the Watkins et al. (2013) study (5.2 ng/mL) and the lower end of the 4th quartile serum PFHxS level in the Kataria et al. (2015) study (≥ 4 ng/mL) suggests that the serum PFHxS levels were higher in the Watkins et al. (2013) study.

Epidemiology Studies—Alterations in Uric Acid Levels. In adolescent NHANES participants, no associations between serum PFHxS levels and serum uric acid levels (Gleason et al. 2015; Kataria et al. 2015) or risk of hyperuricemia (Gleason et al. 2015) were found. A study of Taiwanese adolescents found an association between serum PFHxS levels and serum uric acid levels, but did not find increased risks of hyperuricemia (Qin et al. 2016).

Laboratory Animal Studies. Male rats treated by gavage with 10 mg/kg/day PFHxS for at least 42 days showed a significant increase in BUN levels, but there were no significant gross or microscopic alterations in the kidneys (Butenhoff et al. 2009a; Hoberman and York 2003); the NOAEL was 3 mg/kg/day. No significant effect on BUN was reported in female rats.

2. HEALTH EFFECTS

PFNA

Epidemiology Studies—Biomarkers of Renal Function. Two epidemiology studies have evaluated the possible associations between serum PFNA and alterations in renal function biomarkers. In a study of children participating in the C8 Health Project, an inverse association between serum PFNA and estimated glomerular filtration rate was observed, but not in adolescents participating in NHANES (Watkins et al. 2013). Mundt et al. (2007) noted that there were small, but not clinically significant, alterations in BUN, creatinine, and serum uric acid levels in workers exposed to PFNA.

Epidemiology Studies—Alterations in Uric Acid Levels. Gleason et al. (2015) found an association between serum PFNA and serum uric acid levels in adolescents; this association was not found in other studies of adolescents (Kataria et al. 2015; Qin et al. 2016). Studies by Gleason et al. (2015) and Qin et al. (2016) did not find increases in the risk of hyperuricemia associated with serum PFNA levels.

PFDeA

Epidemiology Studies—Alterations in Uric Acid Levels. Epidemiology studies examining renal outcomes are limited to a study of Taiwanese adolescents that found no association between serum PFDeA levels and serum uric acid levels and did not find increased risks of hyperuricemia (Qin et al. 2016).

Laboratory Animal Studies. Administration of a single dose of up to 80 mg/kg PFDeA to female C57BL/6N mice by gavage did not induce gross or microscopic changes in the kidneys (Harris et al. 1989). However, 2 out of 10 mice that died following administration of a dose of 320 mg/kg showed mild acute necrosis of the proximal convoluted tubules.

PFUA

Laboratory Animal Studies. Treatment of male and female rats with 1.0 mg/kg/day PFUA via gavage for 41–46 days resulted in significant increases in BUN levels (35–61% in males, 19–45% in females) and alkaline phosphatase activity (86–140% in males, 83% in females) and significant decreases in total protein (11% in males, 10–13% in females) and albumin (7% in males) levels (Takahashi et al. 2014); the NOAEL was 0.3 mg/kg/day.

2. HEALTH EFFECTS

PFBuS

Epidemiology Studies—Alterations in Uric Acid Levels. Serum PFBuS levels were not associated with serum uric acid levels or increases in the risk of hyperuricemia in a study of adolescents in Taiwan (Qin et al. 2016).

Laboratory Animal Studies. Treatment of female rats with 900 mg/kg/day PFBuS by gavage for 28 days caused a significant increase (9–11%) in absolute and relative kidney weight, but caused no significant alterations in the microscopic appearance of the kidneys (3M 2001). The weight of the kidneys returned to control levels following a recovery period of approximately 14 days; the NOAEL for kidney weight effects was 300 mg/kg/day PFBuS. In a 90-day rat study, PFBuS did not result in alterations in kidney weights, but did result in hyperplasia of the medullary and papillary tubular and ductal epithelial cells in the inner medullary region at 600 mg/kg/day, but not at 200 mg/kg/day (Lieder et al. 2009a). Minimal to moderate papillary epithelial tubular/acinar hyperplasia was also observed in a 2-generation rat study at 300 mg/kg/day; the study identified a NOAEL of 100 mg/kg/day (Lieder et al. 2009b).

PFBA

Laboratory Animal Studies. No alterations in renal morphology or clinical indications of impaired renal function were reported in rats treated with PFBA in doses of up to 184 mg/kg/day for 5 days (3M 2007a), 150 mg/kg/day for 28 days (Butenhoff et al. 2012a; van Otterdijk 2007a), or 30 mg/kg/day by gavage for 90 days (Butenhoff et al. 2012a; van Otterdijk 2007b).

PFDoA

Epidemiology Studies—Alterations in Uric Acid Levels. In adolescents, no associations between serum PFDoA levels and serum uric acid levels or the risk of hyperuricemia were observed (Qin et al. 2016).

PFHxA

Epidemiology Studies—Alterations in Uric Acid Levels. In adolescents, no associations between serum PFHxA levels and serum uric acid levels or the risk of hyperuricemia were observed (Qin et al. 2016).

2. HEALTH EFFECTS

Laboratory Animal Studies. In a 2-year gavage study, treatment of female rats with 200 mg/kg/day PFHxA resulted in mild renal tubular degeneration and mild to severe papillary necrosis (Klaunig et al. 2015); the NOAEL was 100 mg/kg/day. In addition, urinalysis revealed an increased mean urine volume and reduced specific gravity. There were no histological alternations in the kidneys of males.

2.11 DERMAL

Overview. No studies were located regarding dermal effects in humans. Studies in laboratory animals have not found dermal effects following head-only inhalation exposure to PFOA (see Table 2-1) or oral exposure to PFOA, PFOS, or PFBA (see Tables 2-3, 2-4, and 2-5). Dermal exposure to PFOA has resulted in skin damage (see Table 2-6).

PFOA

In an inhalation head-only exposure study, no histopathological alterations were observed in the abdominal skin of male rats exposed to ≤ 84 mg/m³ APFO dusts for 2 weeks (Kennedy et al. 1986).

No microscopic alterations were observed in the skin following oral exposure of rats to ≤ 100 –110 mg/kg/day APFO via the diet for 90 days (Griffith and Long 1980) or monkeys exposed to up to 20 mg/kg/day PFOA or 0.75 mg/kg/day PFOS for 26 weeks (Butenhoff et al. 2002; Seacat et al. 2002).

Application of a single dose of 5,000 mg/kg of an aqueous paste of APFO to a clipped area of the skin of rats, and left in place covered for 24 hours produced mild skin irritation (Kennedy 1985); no irritation was apparent with a dose of 3,000 mg/kg. In a 2-week dermal exposure study, skin irritation was observed in rats exposed to 200 mg/kg/day (Kennedy 1985). Acute necrotizing dermatitis was observed in two out of five rats exposed to 2,000 mg/kg/day; this lesion was observed after the 10th treatment. Application of 500 mg/kg APFO to the intact or abraded skin of young rabbits and left covered for 24 hours was non-irritating, as scored according to the Draize procedure immediately after removal of the cover and 48 hours later (Griffith and Long 1980).

2. HEALTH EFFECTS

PFOS

Administration of up to approximately 1.04 mg/kg/day PFOS to rats in the diet for 2 years did not induce morphological alterations in the skin (Butenhoff et al. 2012b; Thomford 2002b).

PFBA

There were no significant gross or microscopic alterations in the skin of rats receiving gavage doses of ≤ 150 mg/kg/day PFBA for 28 days or ≤ 30 mg/kg/day PFBA for 90 days (Butenhoff et al. 2012a; van Otterdijk 2007a, 2007b).

2.12 OCULAR

Overview. No information was located regarding ocular effects in humans. Ocular irritation has been observed in laboratory animals following exposure to airborne APFO dust or instillation of PFOA into the eye (see Tables 2-1 and 2-6). However, ocular effects have not been found following oral exposure to PFOA, PFOS, PFBuS, or PFBA (see Tables 2-3, 2-4, and 2-5).

PFOA

Rats exposed to 18,600 mg/m³ APFO dusts for 1 hour exhibited a red material around the eyes and lacrimation during exposure (Griffith and Long 1980). Male rats exposed to ≥ 810 mg/m³ APFO dusts for 4 hours showed corneal opacity and corrosion, which was confirmed by fluorescein staining (Kennedy et al. 1986). Examination of the eyes of male rats exposed intermittently to up to 84 mg/m³ APFO for 2 weeks using a bright light and a slit-lamp biomicroscope on days 5 and 9 of exposure did not reveal any significant exposure-related alterations (Kennedy et al. 1986). Microscopic examination of the eyes from these rats at termination and following a recovery period of up to 42 days was unremarkable.

In oral exposure studies, examination of the eyes from rats exposed to approximately 100–110 mg/kg/day APFO in the diet for 90 days did not reveal any significant gross or microscopic alterations (Griffith and Long 1980). Similar results were reported in rats that received dietary doses up to 15 mg/kg/day APFO for 2 years (3M 1983) and in monkeys dosed with up to 20 mg/kg/day APFO for 26 weeks (Butenhoff et al. 2002).

2. HEALTH EFFECTS

No significant gross alterations were observed in the eyes of rats following repeated dermal exposure to APFO (Kennedy 1985). Microscopic examination of the eyes also did not reveal treatment-related changes. In a study in rabbits, 0.1 g APFO was instilled once in the conjunctival sac of the right eye and examinations were conducted after 1, 24, 48, and 72 hours and 5 and 7 days after the application (Griffith and Long 1980). APFO produced moderate irritation of the eye characterized by iridal and conjunctival effects. The effects were most pronounced 1 hour after instillation. The irritation was persistent, but by day 7, it had subsided. In a different experiment in which 0.1 g APFO was instilled for 5 or 30 seconds before washing with 200 mL of water, there was limited conjunctival irritation, but the effects were immediate and persistent.

PFOS

No gross or microscopic alterations were observed in the eyes from rats exposed to ≤ 1.77 mg/kg/day PFOS in the diet for 4 weeks or ≤ 1.56 mg/kg/day for 14 weeks (Seacat et al. 2003). Similar findings were reported in monkeys dosed daily with up to 2 mg/kg/day PFOS administered via a capsule for 4 weeks (Thomford 2002a) or up to 0.75 mg/kg/day PFOS administered via a capsule for 26 weeks (Seacat et al. 2002), and in rats dosed with up to 1.04 mg/kg/day in the diet for 2 years (Butenhoff et al. 2012b; Thomford 2002b).

PFBuS

No gross and microscopic alterations were observed in the eyes of rats administered ≤ 900 mg/kg/day PFBuS via gavage for 28 days (3M 2001).

PFBA

Examination of the eyes of rats orally exposed to ≤ 150 mg/kg/day PFBA for 28 days or ≤ 30 mg/kg/day for 90 days did not reveal any significant alterations in the eyes (Butenhoff et al. 2012a; van Otterdijk 2007a, 2007b).

2.13 ENDOCRINE

Overview. Epidemiology studies have examined a number of endocrine targets including thyroid gland and hormones, reproductive hormones, and insulin levels. A discussion of the thyroid effects is included

2. HEALTH EFFECTS

in this section; the reproductive hormone effects are discussed in Section 2.16, Reproductive, and the insulin effects (as well as other effects associated with glucose metabolism and utilization) are discussed in Section 2.18, Other Noncancer. Summaries of results of epidemiology studies evaluating thyroid outcomes are presented in Table 2-15; more in-depth summaries of the studies are presented in the *Supporting Document for Epidemiological Studies for Perfluoroalkyls*, Table 9. The results of community and general population studies suggest an association between serum PFOA and an increased risk of thyroid disease. There is also limited support of an association between serum PFOS and thyroid disease. Although some associations between serum PFOA or PFOS and thyroid stimulating hormone (TSH), triiodothyronine (T3), or thyroxine (T4) levels have been found, the results are not consistent across studies. A small number of studies have evaluated PFHxS, PFNA, and PFDeA and most studies have not found consistent associations between serum perfluoroalkyl levels and thyroid hormone levels.

Laboratory animal studies have primarily evaluated potential morphological alterations in endocrine tissues following oral exposure; these studies are summarized in Tables 2-3, 2-4, and 2-5. Some alterations in thyroid hormone levels have been observed in laboratory animals exposed to PFOA, PFOS, or PFDeA. Histopathological alterations have been observed in the thyroid of some laboratory animal studies for PFHxS and PFBA; the investigators noted that these effects were likely secondary to the hepatocellular hypertrophy. In general, the pituitary, parathyroid, thyroid, and adrenal glands do not appear to be sensitive targets following exposure to PFOA, PFOS, or PFBuS.

PFOA

Epidemiology Studies. A number of epidemiology studies have examined the potential of PFOA to damage the thyroid. Steenland et al. (2015) did not find an association between serum PFOA and the risk of thyroid disease in male or female workers at the Washington Works facility. The occupational exposure studies do not suggest an association between serum PFOA and alterations in thyroid hormone levels. One study (Olsen and Zobel 2007) reported associations between serum PFOA levels and free T4 and T3 levels in workers at 3M facilities; it is noted that the investigators did not consider the results clinically relevant since the levels were within the normal range. Another study reported an association between serum PFOA and TSH, but this was only observed at one time point (Olsen et al. 1998b). A fourth occupational study reported that TSH, T4, and T3 levels were within the reference range (Sakr et al. 2007b).

2. HEALTH EFFECTS

Table 2-15. Summary of Thyroid Outcomes in Humans^a

Reference and study population ^b	Serum perfluoroalkyl level	Outcome evaluated	Result ^c
PFOA			
Olsen et al. 1998b Occupational (n=111 in 1993 and n=80 in 1995)	10,000–<30,000 ng/mL (PFOA range)	TSH	NS (p=0.09 for trend), 1993 group Association (p=0.002), 1995 group
Sakr et al. 2007b Occupational (n=1,025)	428 ng/mL (mean PFOA)	TSH T4 T3	The investigators noted that the levels were within the reference range
Steenland et al. 2015 Occupational (n=3,713)	Cumulative PFOA	Thyroid disease risk	NS (p=0.98 for trend) no lag, males NS (p=0.55 for trend) 10-year lag, males NS (p=0.97 for trend) no lag, females NS (p=0.27 for trend) 10-year lag, females
Olsen and Zobel 2007 Occupational (n=552)	2,210 ng/mL (mean PFOA)	Free T4 T4 T3 TSH	Association (p=0.01)* NS (p=0.29) Association (p=0.05)* NS (p=0.08)
Anderson-Mahoney et al. 2008 Community (n=566)	NR	Self-reported thyroid problems	SPR 1.56 (1.22–1.98)*
Emmett et al. 2006b Community (n=371)	354 ng/mL (median PFOA)	TSH	NS (p>0.05)

2. HEALTH EFFECTS

Table 2-15. Summary of Thyroid Outcomes in Humans^a

Reference and study population ^b	Serum perfluoroalkyl level	Outcome evaluated	Result ^c
Knox et al. 2011a Community (n=50,113 adults ≥20 years of age)	52.6, 91.0, 98.6, and 124.3 ng/mL (mean PFOA in women ≤50 year, men ≤50 years, women >50 years, men >50 years)	T4	Association (p≤0.0001)*, women ≤50 years Association (p<0.001), men and women >50 years
		T3 uptake	Inverse association (p=0.0001)* women ≤50 years Inverse association (p=0.005)*, women >50 years Inverse association (p=0.037)*, men >50 years
Lopez-Espinosa et al. 2012 Community (n=10,725 children aged 1–17 years)	29.3 and 67.7–2,071 ng/mL (median and 4 th quartile PFOA)	Thyroid disease	OR 1.44 (1.02–2.03)*, per interquartile shift
		Hypothyroidism	OR 1.54 (1.00–2.37)*, per interquartile shift
		Subclinical hypothyroidism	OR 0.98 (0.86–1.15), per interquartile shift
		Subclinical hyperthyroidism	OR 0.81 (0.58–1.15), per interquartile shift
		TSH	β -1.1 (-5.3–3.4), 4 th quartile
Winqvist and Steenland 2014b Community (C8 and occupational) (n=28,541)	114.7–<202.2 ng/mL-year (2 nd quintile cumulative PFOA)	Functional thyroid disease	HR 1.24 (1.02–1.51;p=0.031)* (women), retrospective analysis HR 1.01 (0.94–1.07 per log linear increase in PFOA, p=0.853) (men), retrospective analysis NS (p=0.549) (women), prospective analysis NS (p=0.087) (men), prospective analysis
		Total T4	β -0.1 (-1.7–1.4), 4 th quartile

2. HEALTH EFFECTS

Table 2-15. Summary of Thyroid Outcomes in Humans^a

Reference and study population ^b	Serum perfluoroalkyl level	Outcome evaluated	Result ^c
		Hyperthyroidism	NS (p=0.074) (women), retrospective analysis NS (p=0.858) (men), retrospective analysis NS (p=0.268) (women), prospective analysis NS (p=0.760) (men), prospective analysis
		Hypothyroidism	NS (p=0.076) (women), retrospective analysis NS (p=0.684) (men), retrospective analysis NS (p=0.247) (women), prospective analysis HR 1.24 (1.03–1.49)* (men), prospective analysis
Bloom et al. 2010	1.33 ng/mL (geometric mean PFOA)	TSH	NS (p=0.871)
General population (n=31)		Free T4	NS (p=0.896)
Chan et al. 2011	1.28 and 1.37 ng/mL (geometric mean PFOA in cases and controls)	Hypothyroxinemia risk	OR 0.94 (0.74–1.18)
General population (n=94 women with hypothyroxinemia and 175 matched controls)			
Jain 2013	NR	Total T3	Association (p=0.013)*
General population (NHANES) (n=1,525)		TSH	NS (p>0.05)
		Free T3	NS (p>0.05)
		Free T4	NS (p>0.05)
		Total T4	NS (p>0.05)
		Thyroglobulin	NS (p>0.05)
Ji et al. 2012	2.74 ng/mL (median PFOA)	TSH	NS (p=0.4055)
General population (n=633)		T4	NS (p=0.2221)

2. HEALTH EFFECTS

Table 2-15. Summary of Thyroid Outcomes in Humans^a

Reference and study population ^b	Serum perfluoroalkyl level	Outcome evaluated	Result ^c
Lewis et al. 2015 General population (NHANES) (n=1,682)	1.42–2.55 ng/mL (range of median PFOA for different age groups)	TSH	Association (p<0.05)*, 12–20-year-old females
		Free T4	Association (p<0.05)*, 20–<40-year-old females
		Total T4	NS (p>0.05)
		Free T3	Association (p<0.05)*, 60–80-year-old females
		Total T3	Association (p<0.05)*, 60–80-year-old females
Melzer et al. 2010 General population (NHANES) (n=3,966)	9.47 and 10.39 ng/mL (4 th PFOA quartile mean in women and men)	Thyroid disease risk	OR 1.64 (1.09–2.46)*, females OR 1.58 (0.74–3.39), males
Raymer et al. 2012 General population (n=256)	10.4 ng/mL (mean PFOA)	TSH	NS (p>0.05)
		T3	NS (p>0.05)
		T4	NS (p>0.05)
Shrestha et al. 2015 General population (n=87 with thyroid disease)	9.17 ng/mL (geometric mean PFOA)	TSH	NS (p=0.176)
		Free T4	NS (p=0.536)
		T4	NS (p=0.097)
		T3	NS (p=0.208)
Wang et al. 2013a General population (n=903 pregnant women)	2.13 ng/mL (geometric mean PFOA)	TSH	NS (p>0.05)
		Elevated TSH risk	NS (p>0.05)
Wang et al. 2014 General population (n=285 pregnant women)	2.39 ng/mL (median PFOA)	TSH	NS (p>0.05)
		Free T4	NS (p>0.05)
		Total T4	NS (p>0.05)
		Total T3	NS (p>0.05)

2. HEALTH EFFECTS

Table 2-15. Summary of Thyroid Outcomes in Humans^a

Reference and study population ^b	Serum perfluoroalkyl level	Outcome evaluated	Result ^c
Webster et al. 2016 General population (NHANES) (n=1,525)	4.2 ng/mL (geometric mean PFOA)	TSH	NS (p>0.05)
		Free T4	NS (p>0.05)
		Total T4	NS (p>0.05)
		Free T3	Association (p<0.05)*
		Total T3	NS (p<0.05)
Wen et al. 2013 General population (NHANES) (n=1,181)	4.15 ng/mL (geometric mean PFOA)	TSH	NS (p=0.916), men NS (p=0.732), women
		Total T4	NS (p=1.0), men NS (p=0.705), women
		Total T3	NS (p=0.673), men Association (p=0.035)*, women
		Thyroglobulin	NS (p=0.226), men NS (p=0.341), women
		Subclinical hypothyroidism risk	OR 1.29 (0.40–4.10), men OR 7.42 (1.14–48.12, p<0.05), women
		Subclinical hyperthyroidism risk	OR 0.38 (0.16–0.95, p<0.05)*, men OR 0.99 (0.13–7.59), women
Yang et al. 2016a General population (n=157 pregnant women)	1.95 ng/mL (mean PFOA)	TSH	NS (p>0.05)
		Free T4	NS (p>0.05)
		Total T4	NS (p>0.05)
		Free T3	NS (p>0.05)
		Total T3	NS (p>0.05)
PFOS			
Olsen et al. 1998a Occupational (n=327)	1,480–2,440 ng/mL (range of mean PFOS)	TSH	NS (p=0.95)
		Cortisol	NS (p=0.45)
Olsen et al. 2003a Occupational (n=518)	1,320 and 800 ng/mL (mean PFOS)	T3	Association (p=0.04)*

2. HEALTH EFFECTS

Table 2-15. Summary of Thyroid Outcomes in Humans^a

Reference and study population ^b	Serum perfluoroalkyl level	Outcome evaluated	Result ^c
Knox et al. 2011a Community (n=50,113 adults ≥20 years of age)	17.3, 24.8, 25.7, and 29.1 ng/mL (mean PFOA in women ≤50 year, men ≤50 years, women >50 years, men >50 years)	T4	Association (p<0.0001)*, women ≤50 or >50 years Association (p=0.0001)*, men ≤50 or >50 years
		T3 uptake	Inverse association (p<0.0001)* women ≤50 years Inverse association (p=0.0001)*, women >50 years Inverse association (p=0.009)*, men ≤50 years Inverse association (p=0.0001)*, men >50 years
Lopez-Espinosa et al. 2012 Community (n=10,725 children aged 1–17 years)	20.0 ng/mL (median PFOS)	Thyroid disease	OR 0.8 (0.62–1.08), per interquartile shift
		Hypothyroidism	OR 0.91 (0.63–1.31), per interquartile shift
		Subclinical hypothyroidism	OR 0.99 (0.86–1.13), per interquartile shift
		Subclinical hyperthyroidism	OR 0.80 (0.62–1.02), per interquartile shift
		TSH	β -1.0 (-0.3–2.3), per interquartile shift
		Total T4	β 1.1 (0.6–1.5), per interquartile shift
Berg et al. 2015 General population (n=391)	8.1–11.0 ng/mL (3 rd PFOS quartile)	TSH	Association (p=0.03)*, 3rd quartile
Bloom et al. 2010 General population (n=31)	19.57 ng/mL (geometric mean PFOS)	TSH	NS (p=0.896)
		Free T4	NS (p=0.623)
Chan et al. 2011 General population (n=94 women with hypothyroxinemia and 175 matched controls)	7.59 and 7.08 ng/mL (geometric mean PFOS in cases and controls)	Hypothyroxinemia risk	OR 0.88 (0.63–1.24)

2. HEALTH EFFECTS

Table 2-15. Summary of Thyroid Outcomes in Humans^a

Reference and study population ^b	Serum perfluoroalkyl level	Outcome evaluated	Result ^c
Dallaire et al. 2009 General population (n=623)	18.28 ng/mL (geometric mean PFOS)	TSH	Inverse association (p≤0.05)*
		T3	Inverse association (p≤0.05)*
		T4-binding globulin	Inverse association (p≤0.01)*
		Free T4	Association (p≤0.05)*
Jain 2013 General population (NHANES) (n=1,525)	NR	TSH	NS (p>0.05)
		Free T3	NS (p>0.05)
		Total T3	NS (p>0.05)
		Free T4	NS (p>0.05)
		Total T4	NS (p>0.05)
		Thyroglobulin	NS (p>0.05)
Ji et al. 2012 General population (n=633)	7.96 ng/mL (median PFOS)	TSH	NS (p=0.3537)
		T4	NS (p=0.1134)
Lewis et al. 2015 General population (NHANES) (n=1,682)	3.76–11.1 ng/mL (range of median PFOS for different age groups)	TSH	NS (p>0.05)
		Free T4	Association (p<0.05)*, 20–<40-year-old females
		Total T4	NS (p>0.05)
		Free T3	NS (p>0.05)
		Total T3	NS (p>0.05)
Melzer et al. 2010 General population (NHANES) (n=3,966)	57.73 and 50.96 ng/mL (4 th PFOS quartile mean in women and men)	Thyroid disease risk	OR 1.15 (0.7–1.91, p=0.568), females OR 1.58 (0.72–3.47, p=0.251), males OR 2.68 (1.03–6.98, p=0.043)*, males 4th quartile versus combined 1st and 2nd quartiles
Raymer et al. 2012 General population (n=256)	37.4 ng/mL (mean PFOS)	TSH	NS (p>0.05)
		T3	NS (p>0.05)
		T4	NS (p>0.05)

2. HEALTH EFFECTS

Table 2-15. Summary of Thyroid Outcomes in Humans^a

Reference and study population ^b	Serum perfluoroalkyl level	Outcome evaluated	Result ^c
Shrestha et al. 2015 General population (n=87 with thyroid disease)	31.6 ng/mL (geometric mean PFOS)	TSH	NS (p=0.094)
		Free T4	Association (p=0.044)*
		T4	Association (p=0.001)*
		T3	NS (p=0.287)
Wang et al. 2013a General population (903 pregnant women)	12.77 ng/mL (geometric mean PFOS)	TSH	Association (p=0.03)*
		Elevated TSH risk	NS (p>0.05)
Wang et al. 2014 General population (285 pregnant women)	12.73 ng/mL (median PFOS)	TSH	NS (p>0.05)
		Free T4	NS (p>0.05)
		Total T4	NS (p>0.05)
		Total T3	NS (p>0.05)
Webster et al. 2016 General population (NHANES) (n=1,525)	13.9 ng/mL (geometric mean PFOS)	TSH	NS (p>0.05)
		Free T4	NS (p>0.05)
		Total T4	NS (p>0.05)
		Free T3	NS (p>0.05)
		Total T3	NS (p<0.05)
Wen et al. 2013 General population (NHANES) (n=1,181)	14.2 ng/mL (geometric mean PFOS)	TSH	NS (p=0.931), men NS (p=0.358), women
		Total T4	NS (p=0.840), men NS (p=0.433), women
		Total T3	NS (p=0.404), men NS (p=0.384), women
		Thyroglobulin	NS (p=0.342), men NS (p=0.061), women
		Subclinical hypothyroidism risk	OR 1.98 (1.19–3.28, p<0.05)*, men OR 3.03 (1.14–8.07, p<0.05)*, women
		Subclinical hyperthyroidism risk	OR 0.92 (0.19–4.46), men OR 1.90 (0.33–6.80), women

2. HEALTH EFFECTS

Table 2-15. Summary of Thyroid Outcomes in Humans^a

Reference and study population ^b	Serum perfluoroalkyl level	Outcome evaluated	Result ^c
Yang et al. 2016a	5.08 ng/mL (mean PFOS)	TSH	Inverse association (p<0.01)*
General population (n=157 pregnant women)		Free T4	NS (p>0.05)
		Total T4	NS (p>0.05)
		Free T3	NS (p>0.05)
		Total T3	NS (p>0.05)
PFHxS			
Bloom et al. 2010	0.75 ng/mL (geometric mean PFHxS)	TSH	NS (p=0.956)
General population (n=31)		Free T4	NS (p=0.567)
Chan et al. 2011	1.28 and 1.37 ng/mL (geometric mean PFHxS in cases and controls)	Hypothyroxinemia risk	OR 1.12 (0.89–1.41)
General population (n=94 women with hypothyroxinemia and 175 matched controls)			
Jain 2013	NR	TSH	NS (p>0.05)
General population (NHANES) (n=1,525)		Free T3	NS (p>0.05)
		Total T3	NS (p>0.05)
		Free T4	NS (p>0.05)
		Total T4	NS (p>0.05)
		Thyroglobulin	NS (p>0.05)
Ji et al. 2012	1.51 ng/mL (median PFHxS)	TSH	NS (p=0.8144)
General population (n=633)		T4	NS (p=0.5147)
Lewis et al. 2015	0.69–1.81 ng/mL (range of median PFHxS for different age groups)	TSH	NS (p>0.05)
General population (NHANES) (n=1,682)		Free T4	NS (p>0.05)
		Total T4	NS (p>0.05)
		Free T3	NS (p>0.05)
		Total T3	NS (p>0.05)
Wang et al. 2013a	0.62 ng/mL (geometric mean PFHxS)	TSH	NS (p>0.05)
General population (n=903 pregnant women)		Elevated TSH risk	NS (p>0.05)

2. HEALTH EFFECTS

Table 2-15. Summary of Thyroid Outcomes in Humans^a

Reference and study population ^b	Serum perfluoroalkyl level	Outcome evaluated	Result ^c
Wang et al. 2014 General population (n=285 pregnant women)	0.81 ng/mL (median PFHxS)	TSH	Association (p<0.05)
		Free T4	NS (p>0.05)
		Total T4	NS (p>0.05)
		Total T3	NS (p>0.05)
Webster et al. 2016 General population (NHANES) (n=1,525)	1.9 ng/mL (geometric mean PFHxS)	TSH	NS (p>0.05)
		Free T4	NS (p>0.05)
		Total T4	NS (p>0.05)
		Free T3	NS (p>0.05)
		Total T3	NS (p>0.05)
Wen et al. 2013 General population (NHANES) (n=1,181)	2.0 ng/mL (geometric mean PFHxS)	TSH	NS (p=0.608), men NS (p=0.720), women
		Total T4	NS (p=0.641), men Association (p=0.022)*, women
		Total T3	NS (p=0.917), men Association (p<0.001)*, women
		Thyroglobulin	NS (p=0.455), men NS (p=0.725), women
		Subclinical hypothyroidism risk	OR 1.57 (0.76–3.25), men OR 3.10 (1.22–7.86, p<0.05)*, women
		Subclinical hyperthyroidism risk	OR 0.56 (0.24–1.20.92), men OR 12.27 (1.07–4.80.90)*, women
Yang et al. 2016a General population (n=157 pregnant women)	0.63 ng/mL (mean PFHxS)	TSH	NS (p>0.05)
		Free T4	NS (p>0.05)
		Total T4	NS (p>0.05)
		Free T3	NS (p>0.05)
		Total T3	NS (p>0.05)

2. HEALTH EFFECTS

Table 2-15. Summary of Thyroid Outcomes in Humans^a

Reference and study population ^b	Serum perfluoroalkyl level	Outcome evaluated	Result ^c
PFNA			
Mundt et al. 2007 Occupational (n=592)	NR	TSH	Investigators noted differences between groups was small and not clinically relevant
		T4	
		T3	
Lopez-Espinosa et al. 2012 Community (n=10,725 children aged 1–17 years)	1.5 ng/mL (median PFNA)	Thyroid disease	OR 1.05 (0.78–1.41), per interquartile shift
		Hypothyroidism	OR 1.11 (0.77–1.60), per interquartile shift
		Subclinical hypothyroidism	OR 0.99 (0.88–1.12), per interquartile shift
		Subclinical hyperthyroidism	OR 0.78 (0.61–1.01), per interquartile shift
		TSH	β -1.1 (CI 0.7–1.5), per interquartile shift
Bloom et al. 2010 General population (n=31)	0.79 ng/mL (geometric mean PFNA)	TSH	NS (p=0.789)
		Free T4	NS (p=0.424)
Jain 2013 General population (NHANES) (n=1,525)	NR	TSH	NS (p>0.05)
		Free T3	NS (p>0.05)
		Total T3	NS (p>0.05)
		Free T4	NS (p>0.05)
		Total T4	NS (p>0.05)
		Thyroglobulin	NS (p>0.05)
Ji et al. 2012 General population (n=633)	2.09 ng/mL (median PFNA)	TSH	NS (p=0.1354)
		T4	NS (p=0.7436)
Wang et al. 2013a General population (n=903 pregnant women)	0.37 ng/mL (geometric mean PFNA)	TSH	NS (p>0.05)
		Elevated TSH risk	NS (p>0.05)

2. HEALTH EFFECTS

Table 2-15. Summary of Thyroid Outcomes in Humans^a

Reference and study population ^b	Serum perfluoroalkyl level	Outcome evaluated	Result ^c
Wang et al. 2014 General population (n=285 pregnant women)	1.51 ng/mL (median PFNA)	TSH	NS (p>0.05)
		Free T4	Inverse association (p<0.001)*
		Total T4	Inverse association (p<0.001)*
		Total T3	NS (p>0.05)
Webster et al. 2016 General population (NHANES) (n=1,525)	1.5 ng/mL (geometric mean PFNS)	TSH	NS (p>0.05)
		Free T4	NS (p>0.05)
		Total T4	NS (p>0.05)
		Free T3	NS (p>0.05)
		Total T3	NS (p>0.05)
Wen et al. 2013 General population (NHANES) (n=1,181)	1.54 ng/mL (geometric mean PFNA)	TSH	NS (p=0.973), men NS (p=0.407), women
		Total T4	NS (p=0.097), men NS (p=0.632), women
		Total T3	NS (p=0.063), men NS (p=0.258), women
		Thyroglobulin	NS (p=0.537), men NS (p=0.395), women
		Subclinical hypothyroidism risk	OR 1.30 (0.65–2.60), men OR 2.54 (0.40–16.05), women
		Subclinical hyperthyroidism risk	OR 2.41 (0.48–12.04), men OR 1.91 (0.83–4.38), women
Yang et al. 2016a General population (n=157 pregnant women)	0.52 ng/mL (mean)	TSH	Inverse association (p<0.05)*
		Free T4	NS (p>0.05)
		Total T4	NS (p>0.05)
		Free T3	NS (p>0.05)
		Total T3	NS (p>0.05)
PFDeA			
Berg et al. 2015 General population (n=391 pregnant women)	0.31–2.34 ng/mL (4 th PFDeA quartile)	T3	Association (p=0.03) (4th quartile)

2. HEALTH EFFECTS

Table 2-15. Summary of Thyroid Outcomes in Humans^a

Reference and study population ^b	Serum perfluoroalkyl level	Outcome evaluated	Result ^c
Bloom et al. 2010 General population (n=31)	0.21 ng/mL (geometric mean PFDeA)	TSH	NS (p=0.365)
		Free T4	NS (p=0.107)
Jain 2013 General population (NHANES) (n=1,525)	NR	TSH	NS (p>0.05)
		Free T3	NS (p>0.05)
		Total T3	NS (p>0.05)
		Free T4	NS (p>0.05)
		Total T4	NS (p>0.05)
		Thyroglobulin	NS (p>0.05)
Ji et al. 2012 General population (n=633)	0.91 ng/mL (median PFDeA)	TSH	NS (p=0.2721)
		T4	NS (p=0.2176)
Wang et al. 2013a General population (903 pregnant women)	0.09 ng/mL (geometric mean PFDeA)	TSH	NS (p>0.05)
		Elevated TSH risk	NS (p>0.05)
Wang et al. 2014 General population (285 pregnant women)	0.46 ng/mL (median PFDeA)	TSH	NS (p>0.05)
		Free T4	NS (p>0.05)
		Total T4	NS (p>0.05)
		Total T3	Association (p<0.01)*
Yang et al. 2016a General population (n=157 pregnant women)	0.45 ng/mL (mean PFDeA)	TSH	Inverse association (p<0.01)*
		Free T4	NS (p>0.05)
		Total T4	NS (p>0.05)
		Free T3	NS (p>0.05)
		Total T3	NS (p>0.05)
PFUA			
Berg et al. 2015 General population (n=391)	0.4–0.96 ng/mL (4 th PFUA quartile)	Free T3	Association (p=0.00)*, 4th quartile

2. HEALTH EFFECTS

Table 2-15. Summary of Thyroid Outcomes in Humans^a

Reference and study population ^b	Serum perfluoroalkyl level	Outcome evaluated	Result ^c
Bloom et al. 2010	0.20 ng/mL (geometric mean PFUA)	TSH	NS (p=0.527)
		Free T4	NS (p=0.204)
General population (n=31)			
Ji et al. 2012	1.75 ng/mL (median PFUA)	TSH	NS (p=0.5368)
		T4	NS (p=0.0642)
General population (n=633)			
Wang et al. 2013a	0.20 ng/mL (geometric mean PFUA)	TSH	NS (p>0.05)
		Elevated TSH risk	NS (p>0.05)
General population (n=903 pregnant women)			
Wang et al. 2014	3.26 ng/mL (median PFUA)	TSH	NS (p>0.05)
		Free T4	Inverse association (p<0.001)*
		Total T4	Inverse association (p<0.001)*
		Total T3	NS (p>0.05)
General population (n=285 pregnant women)			
Yang et al. 2016a	0.45 ng/mL (mean PFUA)	TSH	Inverse association (p<0.05)*
		Free T4	NS (p>0.05)
		Total T4	NS (p>0.05)
		Free T3	NS (p>0.05)
		Total T3	NS (p>0.05)
General population (n=157 pregnant women)			
PFDaA			
Ji et al. 2012	0.92 ng/mL (median PFDaA)	TSH	NS (p=0.6925)
		T4	NS (p=0.7153)
General population (n=633)			
Wang et al. 2014	0.36 ng/mL (median PFDaA)	TSH	NS (p>0.05)
		Free T4	Inverse association (p<0.001)*
		Total T4	Inverse association (p<0.01)*
		Total T3	NS (p>0.05)
General population (285 pregnant women)			

2. HEALTH EFFECTS

Table 2-15. Summary of Thyroid Outcomes in Humans^a

Reference and study population ^b	Serum perfluoroalkyl level	Outcome evaluated	Result ^c
Yang et al. 2016a General population (n=157 pregnant women)	0.046 ng/mL (mean PFDoA)	TSH	Inverse association (p<0.01)*
		Free T4	Inverse association (p<0.05)*
		Total T4	Inverse association (p<0.05)*
		Free T3	Inverse association (p<0.01)*
		Total T3	Inverse association (p<0.01)*
Me-PFOSA-AcOH			
Jain 2013 General population (NHANES) (n=1,525)	NR	TSH	NS (p>0.05)
		Free T3	NS (p>0.05)
		Total T3	NS (p>0.05)
		Free T4	NS (p>0.05)
		Total T4	NS (p>0.05)
		Thyroglobulin	NS (p>0.05)

^aSee the *Supporting Document for Epidemiological Studies for Perfluoroalkyls*, Table 9 for more detailed descriptions of studies.

^bParticipants in occupational exposure may have also lived near the site and received residential exposure; community exposure studies involved subjects living near PFOA facilities with known exposure to high levels of PFOA.

^cAsterisk indicates association with perfluoroalkyl compound; unless otherwise specified, values in parenthesis are 95% confidence intervals.

HR = hazard ratio; NHANES = National Health and Nutrition Examination Survey; NR = not reported; NS = not significant; OR = odds ratio; PFDeA = perfluorodecanoic acid; PFDoA = perfluorododecanoic acid; PFHxS = perfluorohexane sulfonic acid; PFNA = perfluorononanoic acid; PFOA = perfluorooctanoic acid; PFOS = perfluorooctane sulfonic acid; PFUA = perfluoroundecanoic acid; T3 = triiodothyronine; T4 = thyroxine; TSH = thyroid stimulating hormone

2. HEALTH EFFECTS

Three studies of the community affected by the Washington Works facility reported increases in self-reported thyroid disease (Anderson-Mahoney et al. 2008), any type of functional thyroid disease (Lopez-Espinosa et al. 2012; Winquist and Steenland 2014b), or hypothyroidism (Lopez-Espinosa et al. 2012). No associations between cumulative serum PFOA and hyperthyroidism or hypothyroidism were found in retrospective analysis (Winquist and Steenland 2014b). However, in prospective analysis, an association between cumulative serum PFOA and hypothyroidism was found in men (Winquist and Steenland 2014b). Consistent with the occupational exposure data, no association between serum PFOA and TSH levels was found (Emmett et al. 2006b; Knox et al. 2011a; Lopez-Espinosa et al. 2012). Increases in serum PFOA were also associated with increases in T4 levels and decreases in T3 uptake in adults (Knox et al. 2011a).

A number of studies have examined the thyroid outcomes associated with serum PFOA levels in the general population. An association between serum PFOA and thyroid disease risk was found in female NHANES participants, but not in males (Melzer et al. 2010). Another study utilizing NHANES data (Wen et al. 2013) found an increased risk of subclinical hypothyroidism among women, but not men, and a decreased risk of subclinical hyperthyroidism among men, but not women. A case-control study of women did not find that serum PFOA levels were associated with the risk of hypothyroxinemia (Chan et al. 2011). Although four studies found associations between serum PFOA and T3 levels (Jain 2013; Lewis et al. 2015; Webster et al. 2016; Wen et al. 2013), four other studies did not find these associations (Raymer et al. 2012; Shrestha et al. 2015; Wang et al. 2014; Yang et al. 2016a). No associations between serum PFOA and TSH or T4 (Bloom et al. 2010; Jain 2013; Ji et al. 2012; Lewis et al. 2015; Raymer et al. 2012; Shrestha et al. 2015; Wang et al. 2013a, 2014; Webster et al. 2016; Wen et al. 2013; Yang et al. 2016a) levels were found in the general population studies, with the exception of the study by Lewis et al. (2015), which found an association for TSH and T4 levels.

Laboratory Animal Studies. Repeated intermittent head-only exposure of male rats to up to 84 mg/m³ APFO dusts for 2 weeks did not result in significant gross or microscopic alterations in the thyroid or adrenal gland (Kennedy et al. 1986).

In a 2-generation study in rats, daily treatment of the parental generation with 0, 1, 3, 10, or 30 mg/kg/day APFO by gavage in water for 70–90 days produced an increased incidence of hypertrophy and/or vacuolation of the zona glomerulosa of the adrenal gland from high-dose males (Butenhoff et al. 2004b). The respective incidences were 0/10, 0/10, 0/10, 2/10, and 7/10. This effect was also observed in F1 generation males treated with the same dose level. No explanation was apparent for this finding. In

2. HEALTH EFFECTS

rats dosed with up to 15 mg/kg/day APFO in the diet for 2 years, there were no significant morphological alterations in the adrenals (3M 1983). A study in monkeys treated with APFO also reported effects on the adrenal glands. Griffith and Long (1980) reported diffuse lipid depletion in the adrenals from Rhesus monkeys dosed daily for 90 days with 30 mg/kg/day APFO by gavage. This dose level was lethal to some monkeys; no such effect was seen in monkeys dosed with 10 mg/kg/day.

For the most part, morphological evaluations of other endocrine glands in animals treated with PFOA have been negative. For example, male and female rats dosed via the diet with approximately 100–110 mg/kg/day APFO for 90 days showed no gross or microscopic alterations in the pituitary or thyroid glands (Griffith and Long 1980). Similar observations were reported in the pituitary, thyroid, and parathyroid glands from male and female rats dosed with up to 15 mg/kg/day APFO in the diet for 2 years (3M 1983).

Administration of up to 20 mg/kg/day PFOA administered via a capsule to *Cynomolgus* monkeys for 4 weeks did not significantly alter free T4, total T4, free T3, total T3, or TSH (Thomford 2001). Serum T4 and total T4 were significantly reduced in *Cynomolgus* monkeys dosed with 10 mg/kg/day APFO administered via a capsule for up to 6 months, but were still within the normal range (Butenhoff et al. 2002). No significant changes were seen on serum free T3, total T3, or TSH, or thyroid histology.

The only relevant dermal information is that no morphological alterations were observed in the thyroid of rats following dermal application of up to 2,000 mg/kg/day APFO for 2 weeks in the Kennedy (1985) study.

PFOS

Epidemiology Studies. A number of epidemiology studies have examined the risk of thyroid disease and alterations in thyroid hormone levels to evaluate whether the thyroid gland is a target of PFOS toxicity. In studies of NHANES participants, no increases in the risk of thyroid disease were observed in men or women (Lewis et al. 2015; Melzer et al. 2010). Melzer et al. (2010) did find an increase in the risk of having thyroid disease and currently taking thyroid medication among men, and Wen et al. (2013) found increased risks of subclinical hypothyroidism among men and women. Although some studies have found alterations in thyroid hormone levels, the results are not consistent across studies. Associations between serum PFOS and TSH levels were observed in two general population studies (Berg et al. 2015; Wang et al. 2014). In contrast, two other studies found inverse associations for TSH (Dallaire et al. 2009;

2. HEALTH EFFECTS

Yang et al. 2016a). An occupational exposure study (Olsen et al. 1998a) and eight general population studies (Bloom et al. 2010; Jain 2013; Ji et al. 2012; Lewis et al. 2015; Raymer et al. 2012; Shrestha et al. 2015; Wang et al. 2014; Wen et al. 2013) did not find associations between serum PFOS and TSH levels. Conflicting results were also reported for T3 levels, with some studies reporting associations (Olsen et al. 2003a), inverse associations (Dallaire et al. 2009), or no association (Jain 2013; Lewis et al. 2015; Raymer et al. 2012; Shrestha et al. 2015; Wang et al. 2014; Webster et al. 2016; Wen et al. 2013; Yang et al. 2016a). Most studies did not find an association with T4 levels (Jain 2013; Ji et al. 2012; Lewis et al. 2015; Raymer et al. 2012; Wang et al. 2014; Webster et al. 2016; Wen et al. 2013; Yang et al. 2016a), but three studies did find associations between T4 levels and serum PFOS (Dallaire et al. 2009; Lewis et al. 2015; Shrestha et al. 2015). In NHANES participants with two indicators of thyroid stress (low iodine levels and high thyroid peroxidase antibody), serum PFOS levels were significantly ($p < 0.05$) associated with increases in free and total T3, decreases in free T4, and increases in TSH levels (Webster et al. 2016).

Laboratory Animal Studies. Chang et al. (2008b) conducted a study of thyroid function in rats exposed to PFOS (potassium salt). Administration of a single dose of 15 mg/kg by gavage in water (only dose level tested) reduced serum total T4 significantly at 2, 6, and 24 hours after dosing. This effect was attributed to a PFOS-induced transient increase in tissue availability of thyroid hormones and turnover of T4 with a resulting reduction in serum total T4. Chang et al. (2008b) concluded that PFOS did not induce a classical hypothyroid state or alter the hypothalamic-pituitary-thyroid axis. In another acute-duration study, dosing of pregnant mice with 6 mg/kg/day PFOS (potassium salt) on GDs 6–18 did not affect maternal serum levels of free or total T3 or T4 (Fuentes et al. 2006).

Changes in thyroid hormones have also been reported following intermediate-duration exposure to PFOS. For example, in a 2-generation gavage study in which dosing of rats started before mating and continued through gestation, doses ≥ 0.4 mg/kg/day (the lowest dose tested) caused a significant and dose-related reduction in total T4 in maternal serum on postpartum day 5 (Luebker et al. 2005b). Free T4 and TSH were not significantly affected. Exposure of pregnant rats to ≥ 1 mg/kg/day PFOS on GDs 2–20 induced significant reductions in total T4 and free T4 and less marked reductions in T3 during pregnancy, particularly on GD 7 (Thibodeaux et al. 2003); however, serum TSH values were not significantly altered. A similar study in pregnant mice reported a decrease in total T4 on GD 6 in mice dosed with 20 mg/kg/day PFOS on GDs 1–17 (Thibodeaux et al. 2003). No alterations in total T4 were reported in mice dosed with 15 mg/kg/day. No information was provided regarding other thyroid hormones. Decreases in T4 levels were observed in male and female rats exposed to PFOS in the diet for 28 days

2. HEALTH EFFECTS

(Curran et al. 2008); T3 levels were decreased in female rats exposed to 50 or 100 mg/kg/day and in male rats at 100 mg/kg/day. No histological alterations were observed in the thyroid. Another study with PFOS found no thyroid histological effects in rats exposed to 10.3 mg/kg/day for 1 day, 8.17 mg/kg/day for 7 days, or 7.34 mg/kg/day for 28 days (Elcombe et al. 2012a). Exposure of rats to ≥ 0.27 mg/kg/day PFOS in drinking water for 91 days resulted in decreases in total T4 levels (Yu et al. 2009a), but no changes in T3 or TSH levels (highest dose tested was 2.37 mg/kg/day). Curran et al. (2008) suggested that the apparent decreases in T4 levels, in the absence of TSH alterations and histological alterations in the thyroid, may be a result of measurement error when analog assays (chemiluminometric immunoassay and radioimmunoassay) are used due to binding interference. In a study in Cynomolgus monkeys, T3 was numerically lower than controls in one female and one male monkey dosed with 2 mg/kg/day PFOS by capsule for 4 weeks (Thomford 2002a). However, it is difficult to determine whether the effect was treatment-related based on only two animals. In a 26-week study in Cynomolgus monkeys, the highest dose of PFOS tested, 0.75 mg/kg/day, induced a significant increase in serum TSH (approximately twice control value, but still within the reference range) and a decrease in total T3 at termination, but not at earlier time points; variations in other thyroid hormones, including T4, were inconsistent regarding dose and over time (Seacat et al. 2002). The clinical relevance of the lowered total T3 values was not apparent since there was no indication of a clinical hypothyroid response, and thyroid histology was not altered by treatment with PFOS.

Examination of the adrenal glands from rats dosed with up to 1.77 mg/kg/day PFOS via the diet for 4 or 14 weeks did not show any significant gross or microscopic alterations (Seacat et al. 2003). No significant gross or microscopic lesions were reported in the adrenals, thyroid and parathyroid, or pituitary gland from rats dosed with up to 1.04 mg/kg/day PFOS in the diet for 2 years (Butenhoff et al. 2012b; Thomford 2002b).

PFHxS

Epidemiology Studies. Ten general population studies have evaluated possible associations between serum PFHxS levels and alterations in thyroid hormone levels. With the exception of a study of pregnant women, which found an association between serum PFHxS levels and TSH levels (Wang et al. 2014), and a study of NHANES participants, which found associations between serum PFHxS and total T4 and T3 in women (Wen et al. 2013), the epidemiology studies did not find associations for TSH, T3, or T4 (Bloom et al. 2010; Jain 2013; Ji et al. 2012; Lewis et al. 2015; Wang et al. 2013a, 2014; Webster et al. 2016; Yang et al. 2016a). Chan et al. (2011) did not find an increase in the risk of hypothyroxinemia associated

2. HEALTH EFFECTS

with serum PFHxS levels, but Wen et al. (2013) found increases in the risk of subclinical hypothyroidism and subclinical hyperthyroidism among women, but not men.

Laboratory Animal Studies. Hypertrophy and hyperplasia of the follicular cells were observed in the thyroids of male rats treated with ≥ 3 mg/kg/day PFHxS for at least 42 days (Butenhoff et al. 2009a; Hoberman and York 2003). The NOAEL was 1 mg/kg/day. The investigators noted that the observed changes in rats are consistent with the known effects of inducers of microsomal enzymes where the hepatocellular hypertrophy results in a compensatory hypertrophy and hyperplasia of the thyroid due to an increase in plasma turnover of T4 and associated stimulation of TSH. Neither thyroid hormones nor TSH were measured in the study.

PFNA

Epidemiology Studies. Inverse associations between serum PFNA levels and T4 levels (Wang et al. 2014) and TSH levels (Yang et al. 2016a) have been reported in general population studies. However, several other studies have not found alterations in TSH, T4, or T3 levels associated with serum PFNA levels (Bloom et al. 2010; Jain 2013; Ji et al. 2012; Lopez-Espinosa et al. 2012; Wang et al. 2013a; Webster et al. 2016; Wen et al. 2013; Yang et al. 2016a). The investigators for an occupational exposure study reported that differences in TSH, T4, and T3 levels were small and clinically insignificant in groups of workers exposed to low levels, high levels, or no PFNA (Mundt et al. 2007). No associations were found for thyroid disease, hypothyroidism, or subclinical hypo- or hyperthyroidism among residents living near the Washington Works PFOA facility (Lopez-Espinosa et al. 2012) or in NHANES participants (Wen et al. 2013).

PFDeA

Epidemiology Studies. Most general population studies did not find associations between serum PFDeA levels and TSH, T3, or T4 levels (Bloom et al. 2010; Ji et al. 2012; Wang et al. 2013a, 2014; Yang et al. 2016a). The exceptions were studies by Berg et al. (2015) and Wang et al. (2014), which found associations with T3 levels in pregnant women, and a study by Yang et al. (2016a), which found an inverse association with TSH levels in pregnant women.

2. HEALTH EFFECTS

Laboratory Animal Studies. Administration of a single dose of 80 mg/kg PFDeA to female C57BL/6N mice by gavage resulted in 2- and 4-fold increases in serum T3 and T4, respectively, relative to controls 30 days after dosing (Harris et al. 1989).

PFUA

Epidemiology Studies. Inverse associations between serum PFUA and serum TSH (Yang et al. 2016a) or T4 (Wang et al. 2014) have been reported in pregnant women; another study found an association between PFUA and T3 levels (Berg et al. 2015). However, other general population studies have not found association between PFOA and TSH, T4, or T3 levels (Bloom et al. 2010; Ji et al. 2012; Wang et al. 2013a, 2014; Yang et al. 2016a).

PFBuS

Laboratory Animal Studies. Treatment of rats with up to 900 mg/kg/day PFBuS by gavage for 28 days did not alter the gross or microscopic appearance of the adrenal, pituitary, or thyroid/parathyroid glands (3M 2001). Levels of thyroid hormones in serum were not available in this study.

PFBA

Laboratory Animal Studies. Treatment of rats with up to 184 mg/kg/day PFBA by gavage for 5 days did not affect the gross or microscopic morphology of the adrenal, thyroid, or pituitary glands (3M 2007a). Treatment with ≥ 30 mg/kg/day for 28 or 90 days significantly increased the incidence of hyperplasia/hypertrophy of the follicular epithelium of the thyroid gland (Butenhoff et al. 2012a; van Otterdijk 2007a, 2007b). These changes were not observed following a 3-week recovery period. Van Otterdijk (2007a, 2007b; Butenhoff et al. 2012a) suggested that the thyroid lesion likely reflected an increase in T4 producing follicular cells in response to feedback mechanisms from the increased turnover of T4 by the hypertrophic hepatocytes. None of these studies measured thyroid hormones or TSH in serum.

PFDoA

Epidemiology Studies. Three general population studies have evaluated the effect of PFDoA on thyroid hormone levels. Wang et al. (2014) reported inverse associations between serum PFDoA and free T4 and total T4 in pregnant women; no associations were found for TSH or total T3. In another study of

2. HEALTH EFFECTS

pregnant women (Yang et al. 2016a), inverse associations were found for TSH, free T4, total T4, free T3, and total T3. The third study (Ji et al. 2012) found no associations between serum PFDoA and TSH or T4.

Me-PFOSA-AcOH

Epidemiology Studies. In the only available study examining thyroid outcomes, Jain (2013) found no associations between serum Me-PFOSA-AcOH levels and TSH, T3, or T4 levels in NHANES participants.

2.14 IMMUNOLOGICAL

Overview. Epidemiology studies have evaluated three categories of altered immune response related to exposure to perfluoroalkyls: immunosuppression (altered antibody response, infectious disease resistance), hypersensitivity (asthma, wheezing, eczema, atopic dermatitis, allergies), and autoimmunity. A summary of epidemiology studies evaluating immunological endpoints is presented in Table 2-16; more detailed descriptions of individual studies are presented in the *Supporting Document for Epidemiological Studies for Perfluoroalkyls*, Table 10. In general, the epidemiology studies identify the immune system as a target of perfluoroalkyl toxicity. The strongest evidence of the immunotoxicity of perfluoroalkyls in humans comes from epidemiology studies finding associations evaluating the antibody response to vaccines. Associations have been found for PFOA, PFOS, PFHxS, and PFDeA. There is also some limited evidence for decreased antibody response for PFNA, PFUA, and PFDoA, although many of the studies did not find associations for these compounds. In general, decreases in disease resistance have not been found for PFOA, PFOS, PFHxS, or PFNA. Epidemiology studies have also found increases in the asthma diagnosis that were associated with serum PFOA levels. There is also marginal evidence for PFOS, PFHxS, PFNA, PFDeA, PFBuS, and PFDoA; the evidence was considered marginal due to the small number of studies evaluating the outcome and/or conflicting study results. There are limited data of effects on autoimmunity; epidemiology studies provide suggestive evidence of an association between serum PFOA and the risk of ulcerative colitis. The small number of studies investigating immunotoxicity following exposure to PFHpA did not find associations.

Laboratory animal studies have also evaluated immunosuppression (disease resistance, antibody response, NK cell activity, delayed-type hypersensitivity response, monocyte phagocytosis), hypersensitivity (airway resistance, local lymph node assay), and autoimmunity. In addition, laboratory animal studies

2. HEALTH EFFECTS

Table 2-16. Summary of Immunological Outcomes in Humans^a

Reference and study population ^b	Serum perfluoroalkyl level	Outcome evaluated	Result ^c
PFOA			
Ashley-Martin et al. 2015	NR	IL-33/TSLP (cord blood)	OR 1.1 (0.6–1.8)
General population (1,258 women)		IgE (cord blood)	OR 1.1 (0.6–1.9)
Buser and Scinicariello 2016	3.59 and 3.27 ng/mL (geometric mean 2005–2006 and 2007–2010)	Food allergies	OR 9.09 (3.52–24.90)*, 4th quartile
General population (NHANES) (n=637 and 701 adolescents in 2005–2006 and 2007– 2010)	>4.47 ng/mL (4 th quartile)	Food sensitization	NS (p=0.74 for trend)
Dalsager et al. 2016	2.04–10.12 ng/mL (maternal 3 rd tertile PFOA)	Risk of number of days above the median	
General population (n=359 1–4-year-old children)		Fever	OR 1.97 (1.07–3.62)*, 3rd tertile
		Cough	NS (p>0.05)
		Nasal discharge	NS (p>0.05)
		Diarrhea	NS (p>0.05)
		Vomiting	NS (p>0.05)
		Risk of number of days	
		Fever	OR 1.12 (0.82–1.54), 3 rd tertile
		Cough	NS (p>0.05)
		Nasal discharge	NS (p>0.05)
		Diarrhea	NS (p>0.05)
		Vomiting	NS (p>0.05)
Dong et al. 2013	1.5 and 1.0 ng/mL (mean serum PFOA levels in the asthmatic and non-asthmatic children, respectively; serum levels were not reported for full cohort)	Asthma diagnosis	OR 2.67 (1.49–4.79)*, 3rd quartile
General population (n=231 asthmatic and 225 non-asthmatic children)		IgE	Association (p<0.05)*, asthmatics NS (p>0.05), non-asthmatics
This is the same group of children evaluated by Zhu et al. (2016)		Absolute eosinophil counts	Association (p<0.05)*, asthmatics NS (p>0.05), non-asthmatics
		Eosinophil cationic protein	Association (p<0.05)*, asthmatics NS (p>0.05), non-asthmatics

2. HEALTH EFFECTS

Table 2-16. Summary of Immunological Outcomes in Humans^a

Reference and study population ^b	Serum perfluoroalkyl level	Outcome evaluated	Result ^c
Fei et al. 2010 General population. (n=1,400 pregnant women and young children)	5.6 ng/mL (maternal PFOA)	Risk of hospitalization for infectious disease in young children	IRR 0.96 (0.87–1.06) for trend IRR 1.21 (1.04–1.42)* for trend, girls IRR 0.83 (0.73–0.95)* for trend, boys
Grandjean et al. 2012; Mogensen et al. 2015a General population (n=456 and n=464 children 5 and 7 years of age)	4.1 and 4.4 ng/mL (median PFOA at age 5 and 7 years) 3.20 ng/mL (geometric mean maternal PFOA)	Tetanus antibody levels at age 5	NS, maternal PFOA NS, PFOA at age 5
		Tetanus antibody levels at age 7	NS, maternal PFOA β -35.8% (-51.9 to -14.2)*, per 2-fold increase in PFOA levels at age 5 NS, PFOA at age 7
		Diphtheria antibody levels at age 5	NS, maternal PFOA NS (p=0.69), PFOA at age 5
		Diphtheria antibody levels at age 7	NS, maternal PFOA β -25.2% (-42.9 to -2.0)*, per 2-fold increase in PFOA levels at age 5 β -25.4% (-40.9 to -5.8)*, per 2-fold increase in PFOA levels, PFOA at age 7
Grandjean et al. 2017 General population (n=516 children examined at age 7 and 13 years)	4.4 and 2.0 ng/mL (median PFOA at age 7 and 13 years)	Tetanus antibody levels at age 13	NS (p=0.637), PFOA at age 7 NS (p=0.856), PFOA at age 13
		Diphtheria antibody levels at age 13	Full cohort NS (p=0.742), PFOA at age 7 NS (p=0.129), PFOA at age 13 Cohort restricted to children without possible unscheduled booster vaccines NS (p=0.480), PFOA at age 7 Association (p=0.029)*, PFOA at age 13

2. HEALTH EFFECTS

Table 2-16. Summary of Immunological Outcomes in Humans^a

Reference and study population ^b	Serum perfluoroalkyl level	Outcome evaluated	Result ^c
Granum et al. 2013 General population (n=56 children age 3 years)	1.1 ng/mL (mean maternal PFOA)	Rubella antibody levels	Inverse association (p=0.001)*
		<i>Hemophilus influenza</i> type B antibody levels	NS (p>0.05)
		Tetanus antibody levels	NS (p>0.05)
		Asthma diagnosis	NS (p>0.05)
		Atopic eczema	NS (p>0.05)
		Eczema and itchiness	NS (p>0.05)
		Number of episodes of otitis media	NS (p>0.05)
		Number of episodes of common cold	Association (p<0.001)*
Humblet et al. 2014 General population (NHANES) (n=1,877 adolescents)	4.3 and 4.0 ng/mL (median PFOA in asthmatics and nonasthmatics)	Asthma episode in last 12 months	OR 1.18 (1.01–1.39)*, per doubling PFOA
		Current asthma	NS (p=0.26)
		Wheezing	NS (p=0.98)
Kielsen et al. 2016 General pop. (n=12 adults)	1.69 ng/mL (median PFOA)	Diphtheria antibody levels	NS (p=0.250), unadjusted
		Tetanus antibody levels	NS (p=0.970), unadjusted.
Looker et al. 2014 Community (C8) (n=411)	33.74 ng/mL (geometric mean) 13.8–31.5 ng/mL (2 nd quartile)	Seroprotection from influenza A H3N2 virus	OR 0.34 (0.14–0.83)*, 2nd quartile
		Seroprotection from influenza A H1N1 virus	NS (p=0.02)
		Seroprotection from influenza type B virus	NS (p=0.68)
		Cold or flu infection	NS (p>0.05)
		Frequency of colds	NS (p>0.05)

2. HEALTH EFFECTS

Table 2-16. Summary of Immunological Outcomes in Humans^a

Reference and study population ^b	Serum perfluoroalkyl level	Outcome evaluated	Result ^c
Okada et al. 2012 General population (n=343 pregnant women)	1.3 ng/mL (maternal median PFOA)	Cord IgE levels	NS (p>0.05)
		Males	
		Females	Inverse association (p<0.05)*
		Infant food allergy	OR 1.67 (0.52–5.37)
		Eczema	OR 0.96 (0.23–4.02)
		Wheezing	OR 1.27 (0.27–6.05)
Okada et al. 2014 General population (n=2,603 infants)	2.67 ng/mL (maternal mean PFOA)	Risk of allergic diseases	
		Males	OR 0.63 (0.63–1.37), 4 th quartile
		Females	OR 0.64 (0.42–0.97)*, 4th quartile
		Eczema	
		Males	OR 0.75 (0.48–1.18), 4 th quartile
		Females	OR 0.65 (0.39–1.09), 4 th quartile
Smit et al. 2015 General population (n=1,024 children)	0.97 and 1.79 ng/mL (maternal mean PFOA in Ukraine and Greenland cohorts)	Ever having asthma	OR 0.80 (0.62–1.04), whole cohort
		Ever having eczema	OR 0.97 (0.81–1.17), whole cohort
		Current eczema	OR 1.01 (0.79–1.29), whole cohort
		Ever having wheezing	OR 0.91 (0.76–1.10), whole cohort
		Current wheezing	OR 0.97 (0.71–1.33), whole cohort
		Steenland et al. 2013 Community (C8) (28,441)	Cumulative
Rheumatoid arthritis	NS (p>0.05)		
Crohn's disease	NS (p>0.05)		
Type I diabetes	NS (p>0.05)		
Lupus	NS (p>0.05)		
Multiple sclerosis	NS (p>0.05)		

2. HEALTH EFFECTS

Table 2-16. Summary of Immunological Outcomes in Humans^a

Reference and study population ^b	Serum perfluoroalkyl level	Outcome evaluated	Result ^c
Steenland et al. 2015 Occupational (n=3,713)	Cumulative	Asthma	NS (p=0.27), with no lag NS (p=0.53), with 10-year lag Positive categorical trend (p=0.05)*, with no lag
		Ulcerative colitis	RR 6.57 (1.47–29.40)*, with 10-year lag
		Rheumatoid arthritis	Positive categorical trend (p=0.04)*, with no lag
Stein et al. 2016a General population (NHANES) (n=1,191 adolescents)	4.13 ng/mL (geometric mean)	Measles antibody titers	NS (95% CI included unity)
		Mumps antibody titers	NS (95% CI included unity), whole cohort β -6.6% (-11.7 to -1.5)*, per 2-fold increase in PFOA levels, seropositive subcohort
		Rubella antibody titers	NS (95% CI included unity), whole cohort β -8.9% (-14.6 to -2.9)*, per 2-fold increase in PFOA levels, seropositive subcohort
Stein et al. 2016a General population (NHANES) (n=640 adolescents)	3.59 ng/mL (geometric mean)	Rhinitis	OR 1.35 (1.10–1.66)*
		Current asthma	OR 1.28 (0.81–2.04)
		Wheeze	OR 0.94 (0.51–1.73)
		Allergy	OR 1.12 (0.85–1.47)
		Allergic sensitization	
		Plants	OR 0.88 (0.67–1.15)
		Dust mites	OR 0.93 (0.75–1.16)
		Pets	OR 1.17 (0.81–1.68)
		Cockroach or shrimp	OR 0.79 (0.55–1.13)
Rodents	OR 1.65 (0.59–4.60)		
Mold	OR 1.21 (0.85–1.72)		
Food	OR 1.02 (0.60–1.73)		

2. HEALTH EFFECTS

Table 2-16. Summary of Immunological Outcomes in Humans^a

Reference and study population ^b	Serum perfluoroalkyl level	Outcome evaluated	Result ^c
Stein et al. 2016b General population (n=78 adults receiving influenza vaccine)	2.28 ng/mL (geometric mean)	Seroconversion	
		Hemagglutinin	NS (p=0.07 for trend)
		Immunohistochem.	NS (p=0.27 for trend)
		Serum cytokine levels	NS (p>0.05 for trend)
		Serum chemokine levels	NS (p>0.05 for trend)
		Nasal cytokine levels	NS (p>0.05 for trend)
		Nasal chemokine levels	NS (p>0.05 for trend)
Wang et al. 2011 General population (n=244 children aged 2 years)	1.71 ng/mL (median cord PFOA)	Serum IgE levels	NS (p=0.870)
		Cord blood IgE levels	Association (p=0.047)*
		Atopic dermatitis	NS (p>0.05)
		Zhu et al. 2016 General population (n=231 asthmatic and 225 non-asthmatic children) This is the same group of children evaluated by Dong et al. (2013)	1.51 and 1.00 ng/mL (mean in asthmatics and non-asthmatics)
T-helper cytokines			
IL-4	Association (p=0.001 for trend)*		
IL-5	Association (p=0.004 for trend)*		
IFN- γ	NS (p>0.05 for trend)		
IL-2	NS (p>0.05 for trend)		
		Serum IgE	NS (p>0.05 for trend)
PFOS			
Ashley-Martin et al. 2015 General population (1,258 women)	NR	IL-33/TSLP (cord blood)	1.1 (0.6–1.9)
		IgE (cord blood)	OR 1.1 (0.6–1.9)
Buser and Scinicariello 2016 General population (NHANES) (n=637 and 701 adolescents in 2005–2006 and 2007–2010)	14.98 and 8.74 ng/mL (geometric mean PFOS 2005–2006 and 2007–2010)	Food allergies	OR 2.43 (1.05–5.59)*, 3rd quartile (trend not significant, p=0.27)
	9.17–13.75 ng/mL (3 rd quartile)	Food sensitization	NS (p=0.49 for trend)

2. HEALTH EFFECTS

Table 2-16. Summary of Immunological Outcomes in Humans^a

Reference and study population ^b	Serum perfluoroalkyl level	Outcome evaluated	Result ^c
Dalsager et al. 2016 General population (n=359 1–4-year-old children)	10.19–25.10 ng/mL (maternal 3 rd tertile PFOS)	Risk of number of days above the median	
		Fever	OR 2.35 (1.34–4.11)*, 3rd tertile
		Cough	NS (p>0.05)
		Nasal discharge	NS (p>0.05)
		Diarrhea	NS (p>0.05)
		Vomiting	NS (p>0.05)
		Risk of number of days	
		Fever	OR 1.65 (1.24–2.18)*, 3rd tertile
		Cough	NS (p>0.05)
		Nasal discharge	NS (p>0.05)
Diarrhea	NS (p>0.05)		
Vomiting	NS (p>0.05)		
Dong et al. 2013 General population (n=231 asthmatic and 225 non-asthmatic children) This is the same group of children evaluated by Zhu et al. (2016)	45.5 and 33.4 ng/mL (mean serum PFOS levels in the asthmatic and non-asthmatic children, respectively; serum levels were not reported for full cohort)	Asthma diagnosis	OR 2.63 (1.48–4.69)*, 4th quartile
		Asthma severity	Association (p=0.045 for trend)*
		IgE	Association (p<0.05)*, asthmatics NS (p>0.05), non-asthmatics
		Absolute eosinophil counts	Association (p<0.05)*, asthmatics NS (p>0.05), non-asthmatics
		Eosinophil cationic protein	Association (p<0.05)*, asthmatics NS (p>0.05), non-asthmatics
Fei et al. 2010 General population (n=1,400 pregnant women and young children)	35.3 ng/mL (maternal PFOS)	Risk of hospitalization for infectious disease in young children	IRR 1.00 (0.91–1.09) for trend IRR 1.18 (1.03–1.36)* for trend, girls IRR 0.90 (0.80–1.12) for trend, boys
Grandjean et al. 2012; Mogensen et al. 2015a General population (n=456 and n=464 children 5 and 7 years of age)	17.3 and 15.5 ng/mL (median PFOS at age 5 and 7 years)	Tetanus antibody levels at age 5	NS, maternal PFOS β -28.5% (-45.5 to -6.1)*, per 2-fold increase in PFOS levels at age 5
		Tetanus antibody levels at age 7	NS, maternal PFOS NS, PFOS at ages 5 and 7
	27.3 ng/mL (geometric mean maternal PFOS)	Diphtheria antibody levels at age 5	NS, maternal PFOS NS, PFOS at age 5

2. HEALTH EFFECTS

Table 2-16. Summary of Immunological Outcomes in Humans^a

Reference and study population ^b	Serum perfluoroalkyl level	Outcome evaluated	Result ^c
		Diphtheria antibody levels at age 7	β -27.6% (-45.8 to -3.3)*, per 2-fold increase in PFOS levels at age 5 β -30.3% (47.3 to -7.8)*, per 2-fold increase in PFOS levels at age 7
Grandjean et al. 2017 General population (n=516 children examined at age 7 and 13 years)	15.3 and 6.7 ng/mL (median at age 7 and 13 years)	Tetanus antibody levels at age 13	Full cohort NS (p=0.240), PFOS at age 7 NS (p=0.237), PFOS at age 13 Cohort restricted to children without possible unscheduled booster vaccines Association (p=0.043)*, PFOS at age 7 NS (p=0.144), PFOS at age 13
		Diphtheria antibody levels at age 13	NS (p=0.07), age 7 NS (p=0.454), age 13
Granum et al. 2013 General population (n=56 children age 3 years)	5.6 ng/mL (mean maternal PFOS)	Rubella antibody levels	Inverse association (p=0.007)*
		<i>Hemophilus influenza</i> type B antibody levels	NS (p>0.05)
		Tetanus antibody levels	NS (p>0.05)
		Asthma diagnosis	NS (p>0.05)
		Atopic eczema	NS (p>0.05)
		Eczema and itchiness	NS (p>0.05)
		Number of episodes of otitis media	NS (p>0.05)
		Number of episodes of common cold	NS (p=0.501)
		Number of episodes of gastroenteritis	NS (p=0.367)
Humblet et al. 2014 General population (NHANES) (n=1,877 adolescents)	17.0 and 16.8 ng/mL (median PFOS in asthmatics and non-asthmatics)	Asthma episode in last 12 months	NS (p=0.13), per doubling PFOS
		Current asthma	NS (p=0.24)
		Wheezing	NS (p=0.08)

2. HEALTH EFFECTS

Table 2-16. Summary of Immunological Outcomes in Humans^a

Reference and study population ^b	Serum perfluoroalkyl level	Outcome evaluated	Result ^c
Kielsen et al. 2016	9.52 ng/mL (median PFOS)	Diphtheria antibody levels	Inverse association (p=0.044)*, unadjusted
General population (n=12 adults)		Tetanus antibody levels	NS (p=0.420), unadjusted
Looker et al. 2014	8.32 ng/mL (geometric mean PFOS)	Response to influenza A H3N2 virus vaccine	NS (p>0.05)
Community (C8) (n=411)		Response to influenza A H1N1 virus vaccine	NS (p>0.05)
		Response to influenza type B virus vaccine	NS (p>0.05)
		Cold or flu infection	NS (p>0.05)
		Frequency of colds	NS (p>0.05)
Okada et al. 2012	5.2 ng/mL (maternal median PFOS)	Cord IgE levels	NS (p>0.05)
General population (n=343 infants)		Infant food allergy	OR 3.72 (0.81–17.10)
		Eczema	OR 0.87 (0.15–5.08)
		Wheezing	OR 2.68 (0.39–18.30)
		Otitis media	OR 1.40 (0.33–6.00)
Okada et al. 2014	5.56 ng/mL (maternal mean PFOS)	Risk of allergic diseases	
General population (n=2,603 infants)		Males	OR 0.95 (0.65–1.37), 4 th quartile
		Females	OR 0.79 (0.53–1.17), 4 th quartile
		Eczema	
		Males	OR 0.98 (0.63–1.53), 4 th quartile
		Females	OR 0.84 (0.51–1.38), 4 th quartile
Smit et al. 2015	4.88 and 20.6 ng/mL (maternal mean PFOS in Ukraine and Greenland cohorts)	Ever having asthma	OR 0.86 (0.67–1.10), whole cohort
General population (n=1,024 children)		Ever having eczema	OR 0.98 (0.88–1.18), whole cohort
		Current eczema	OR 1.05 (0.82–1.33), whole cohort
		Ever having wheezing	OR 0.83 (0.69–1.00), whole cohort
		Current wheezing	OR 0.60 (0.38–0.92)*, Ukraine cohort OR 0.91 (0.62–1.36) Greenland OR 0.76 (0.56–1.01), whole cohort

2. HEALTH EFFECTS

Table 2-16. Summary of Immunological Outcomes in Humans^a

Reference and study population ^b	Serum perfluoroalkyl level	Outcome evaluated	Result ^c
Stein et al. 2016a General population (NHANES) (n=1,191 adolescents)	20.8 ng/mL (geometric mean PFOS)	Measles antibody titers	NS (95% CI included unity)
		Mumps antibody titers	β -7.4% (-12.8 to -1.7)*, per 2-fold increase in PFOS levels, whole cohort β -5.9% (-9.9 to -1.6)*, per 2-fold increase in PFOS levels, seropositive subcohort
		Rubella antibody titers	NS (95% CI included unity), whole cohort β -13.3% (-19.9–6.2)*, per 2-fold increase in PFOS levels, seropositive subcohort
Stein et al. 2016a General population (NHANES) (n=640 adolescents)	15.0 ng/mL (geometric mean)	Rhinitis	OR 1.16 (0.90–1.50)
		Current asthma	OR 1.20 (0.88–1.63)
		Wheeze	OR 0.76 (0.45–1.19)
		Allergy	OR 1.05 (0.80–1.37)
		Allergic sensitization	
		Plants	OR 0.17 (0.53–0.97)*
		Dust mites	OR 1.00 (0.73–1.38)
		Pets	OR 0.83 (0.56–1.22)
Cockroach or shrimp	OR 0.67 (0.48–0.93)*		
Rodents	OR 0.85 (0.29–2.45)		
Mold	OR 1.33 (1.06–1.69)*		
Food	OR 0.74 (0.39–1.40)		
Stein et al. 2016b General population (n=78 adults receiving influenza vaccine)	5.22 ng/mL (geometric mean)	Seroconversion	
		Hemagglutinin	NS (p=0.81 for trend)
		Immunohistochemistry	NS (p=0.12 for trend)
		Serum cytokine levels	NS (p>0.05 for trend)
		Serum chemokine levels	NS (p>0.05 for trend)
		Nasal cytokine levels	NS (p>0.05 for trend)
		Nasal chemokine levels	NS (p>0.05 for trend)
Serum IgA levels	NS (p>0.05 for trend)		

2. HEALTH EFFECTS

Table 2-16. Summary of Immunological Outcomes in Humans^a

Reference and study population ^b	Serum perfluoroalkyl level	Outcome evaluated	Result ^c
Wang et al. 2011	5.50 ng/mL (median cord PFOS)	Serum IgE levels	NS (p=0.179)
General population (n=244 children aged 2 years)		Cord blood IgE levels	Association (p=0.017)*
		Atopic dermatitis	NS (p>0.05)
Zhu et al. 2016	45.86 and 33.9 ng/mL (mean in asthmatics and non-asthmatics)	Asthma diagnosis	OR 4.38 (2.02–9.50)*, males 4th quartile NS (p=0.899 for trend), females
General population (n=231 asthmatic and 225 non-asthmatic children)		T-helper cytokines	
		IL-4	NS (p>0.05 for trend)
		IL-5	NS (p>0.05 for trend)
		IFN- γ	NS (p>0.05 for trend)
		IL-2	NS (p>0.05 for trend)
This is the same group of children evaluated by Dong et al. (2013)		Serum IgE	NS (p>0.05 for trend)
PFHxS			
Ashley-Martin et al. 2015	NR	IL-33/TSLP (cord blood)	1.0 (0.7–1.4)
General population (1,258 women)		IgE (cord blood)	OR 1.0 (0.7–1.4)
Buser and Scinicariello 2016	2.09 and 2.19 ng/mL (geometric mean 2005–2006 and 2007–2010)	Food allergies	OR 3.06 (1.35–6.93)*, 4th quartile (trend not significant, p=0.11)
General population (NHANES) (n=637 and 701 adolescents in 2005–2006 and 2007–2010)		Food sensitization	NS (p=0.72 for trend)
	>4.00 ng/mL (4 th quartile)		
Dalsager et al. 2016	0.32 ng/mL (maternal median PFHxS)	Risk of number of days above the median	
General population (n=359 1–4-year-old children)		Fever	NS (p>0.05)
		Cough	NS (p>0.05)
		Nasal discharge	NS (p>0.05)
		Diarrhea	NS (p>0.05)
		Vomiting	NS (p>0.05)

2. HEALTH EFFECTS

Table 2-16. Summary of Immunological Outcomes in Humans^a

Reference and study population ^b	Serum perfluoroalkyl level	Outcome evaluated	Result ^c
		Risk of number of days	
		Fever	NS (p>0.05)
		Cough	NS (p>0.05)
		Nasal discharge	NS (p>0.05)
		Diarrhea	NS (p>0.05)
		Vomiting	NS (p>0.05)
Dong et al. 2013	3.9 and 2.1 ng/mL (mean serum PFHxS levels in the asthmatic and non-asthmatic children, respectively; serum levels were not reported for full cohort)	Asthma diagnosis	OR 2.94 (1.65–5.25)*, 3rd quartile
General population (n=231 asthmatic and 225 non-asthmatic children)		Asthma severity	NS (p=0.722 for trend)
This is the same group of children evaluated by Zhu et al. (2016)		IgE	NS (p>0.05), asthmatics NS (p>0.05), non-asthmatics
		Absolute eosinophil counts	Association (p<0.05)*, asthmatics NS (p>0.05), non-asthmatics
		Eosinophil cationic protein	Association (p<0.05)*, asthmatics NS (p>0.05), non-asthmatics
Grandjean et al. 2012; Mogensen et al. 2015a	0.6 and 0.5 ng/mL (median PFHxS at age 5 and 7 years)	Tetanus antibody levels at age 5	NS, maternal PFHxS -19.0% (-29.8 to -6.6)*, per 2-fold increase in PFHxS levels at age 5
General population (n=456 and n=464 children 5 and 7 years of age)	4.41 ng/mL (geometric mean maternal PFHxS)	Tetanus antibody levels at age 7	NS, maternal PFHxS β -19.7% (-31.6 to -5.7)*, per 2-fold increase PFHxS levels at age 5 β -22.3% (-36.3 to -5.2)*, per 2-fold increase PFHxS levels at age 7
		Diphtheria antibody levels at age 5	NS, maternal PFHxS NS, PFHxS at age 5
		Diphtheria antibody levels at age 7	NS, maternal PFHxS NS, PFHxS at age 5 or 7
Grandjean et al. 2017	0.5 and 0.4 ng/mL (median PFHxS at age 7 and 13 years)	Tetanus antibody levels at age 13	NS (p=0.334), PFHxS at age 7 NS (p=0.568), PFHxS at age 13
General population (n=516 children examined at age 7 and 13 years)		Diphtheria antibody levels at age 13	NS (p=0.264), PFHxS at age 7 NS (p=0.583), PFHxS at age 13

2. HEALTH EFFECTS

Table 2-16. Summary of Immunological Outcomes in Humans^a

Reference and study population ^b	Serum perfluoroalkyl level	Outcome evaluated	Result ^c
Granum et al. 2013 General population (n=56 children age 3 years)	0.3 ng/mL (mean maternal PFHxS levels)	Rubella antibody levels	Inverse association (p=0.008)*
		<i>Hemophilus influenza</i> type B antibody levels	NS (p>0.05)
		Tetanus antibody levels	NS (p>0.05)
		Asthma diagnosis	NS (p>0.05)
		Atopic eczema	NS (p>0.05)
		Eczema and itchiness	NS (p>0.05)
		Number of episodes of otitis media	NS (p>0.05)
		Number of episodes of common cold	NS (p=0.078)
		Number of episodes of gastroenteritis	Association (p=0.007)*
Humblet et al. 2014 General population (NHANES) (n=1,877 adolescents)	2.2 and 2.0 ng/mL (median PFHxS in asthmatics and nonasthmatics)	Asthma episode in last 12 months	NS (p=0.66), per doubling PFHxS
		Current asthma	NS (p=0.99)
		Wheezing	NS (p=0.92)
Kielsen et al. 2016 General population (n=12 adults)	0.37 ng/mL (median PFHxS)	Diphtheria antibody levels	NS (p=0.055), unadjusted
		Tetanus antibody levels	NS (p=0.390), unadjusted
Okada et al. 2014 General population (n=2,603 infants)	0.324 ng/mL (maternal mean PFHxS)	Risk of allergic diseases	
		Males	OR 0.81 (0.56–1.16), 4 th quartile
		Females	OR 1.13 (0.75–1.69), 4 th quartile
		Eczema	
		Males	OR 0.78 (0.51–1.19), 4 th quartile
		Females	OR 0.82 (0.49–1.36), 4 th quartile

2. HEALTH EFFECTS

Table 2-16. Summary of Immunological Outcomes in Humans^a

Reference and study population ^b	Serum perfluoroalkyl level	Outcome evaluated	Result ^c
Smit et al. 2015 General population (n=1,024 children)	1.53 and 2.14 ng/mL (maternal mean PFHxS in Ukraine and Greenland cohorts)	Ever having asthma	OR 0.91 (0.69–1.18), whole cohort
		Ever having eczema	OR 1.03 (0.86–1.24), whole cohort
		Current eczema	OR 0.93 (0.73–1.20), whole cohort
		Ever having wheezing	OR 0.96 (0.79–1.17), whole cohort
		Current wheezing	OR 0.93 (0.68–1.27), whole cohort
Stein et al. 2016a General population (NHANES) (n=1,191 adolescents)	2.47 ng/mL (geometric mean PFHxS)	Measles antibody titers	NS (95% CI included unity)
		Mumps antibody titers	NS (95% CI included unity)
		Rubella antibody titers	NS (95% CI included unity), whole cohort β -6.0% (-9.6 to -2.2)*, per 2-fold increase PFHxS levels, seropositive subcohort
Stein et al. 2016a General population (NHANES) (n=640 adolescents)	2.09 ng/mL (geometric mean PFHxS)	Rhinitis	OR 0.81 (0.57–1.16)
		Current asthma	OR 0.98 (0.51–1.87)
		Wheeze	OR 0.99 (0.68–1.44)
		Allergy	OR 0.83 (0.59–1.17)
		Allergic sensitization	
		Plants	OR 0.93 (0.62–1.39)
		Dust mites	OR 1.01 (0.84–1.22)
		Pets	OR 0.96 (0.71–1.30)
		Cockroach or shrimp	OR 0.72 (0.56–0.93)
		Rodents	OR 0.81 (0.54–1.21)
Mold	OR 0.98 (0.65–1.47)		
Food	OR 1.03 (0.74–1.42)		
Stein et al. 2016b General population (n=78 adults receiving influenza vaccine)	1.1 ng/mL (geometric mean PFHxS)	Seroconversion	
		Hemagglutinin	NS (p=0.22 for trend)
		Immunohistochem.	NS (p=0.34 for trend)
		Serum cytokine levels	
		IFN-γ	Association (p=0.05 for trend)*
		IFN-α2	NS (p=0.09 for trend)
TNF-α	Association (p=0.04 for trend)*		
IP-10	NS (p=0.59 for trend)		

2. HEALTH EFFECTS

Table 2-16. Summary of Immunological Outcomes in Humans^a

Reference and study population ^b	Serum perfluoroalkyl level	Outcome evaluated	Result ^c
		Serum chemokine levels	NS (p>0.05 for trend)
		Nasal cytokine levels	NS (p>0.05 for trend)
		Nasal chemokine levels	NS (p>0.05 for trend)
		Serum IgA levels	NS (p>0.05 for trend)
Zhu et al. 2016	3.86 and 2.10 ng/mL (mean PFHxS in asthmatics and non-asthmatics)	Asthma diagnosis	OR 2.97 (1.33–6.64)*, males 4th quartile OR 5.02 (2.05–12.30)*, females 4th quartile
General population (n=231 asthmatic and 225 non-asthmatic children)		T-helper cytokines	
This is the same group of children evaluated by Dong et al. (2013)		IL-4	NS (p>0.05 for trend)
		IL-5	NS (p>0.05 for trend)
		IFN- γ	NS (p>0.05 for trend)
		IL-2	NS (p>0.05 for trend)
		Serum IgE	NS (p>0.05 for trend)
PFNA			
Buser and Scinicariello 2016	0.93 and 1.13 ng/mL (geometric mean PFNA 2005–2006 and 2007–2010)	Food allergies	NS (p=0.28 for trend)
General population (NHANES) (n=637 and 701 adolescents in 2005–2006 and 2007–2010)	>1.36 ng/mL (4 th quartile)	Food sensitization	OR 0.51 (0.28–0.92)*, 4th quartile (trend not significant, p=0.15)
Dalsager et al. 2016	0.56–0.81 and 0.82–3.64 ng/mL (maternal 2 nd and 3 rd tertile PFNA)	Risk of number of days above the median	
General population (n=359 1–4-year-old children)		Fever	NS (p>0.05)
		Cough	NS (p>0.05)
		Nasal discharge	OR 0.53 (0.31–0.92)*, 2nd tertile
		Diarrhea	NS (p>0.05)
		Vomiting	NS (p>0.05)
		Risk of number of days	
		Fever	NS (p>0.05)
		Cough	NS (p>0.05)
		Nasal discharge	OR 1.12 (0.84–1.49), 3 rd tertile
		Diarrhea	NS (p>0.05)
		Vomiting	NS (p>0.05)

2. HEALTH EFFECTS

Table 2-16. Summary of Immunological Outcomes in Humans^a

Reference and study population ^b	Serum perfluoroalkyl level	Outcome evaluated	Result ^c
Dong et al. 2013 General population (n=231 asthmatic and 225 non-asthmatic children) This is the same group of children evaluated by Zhu et al. (2016)	1.1 and 0.9 ng/mL (mean serum PFNA levels in the asthmatic and non-asthmatic children, respectively; serum levels were not reported for full cohort)	Asthma diagnosis	OR 2.56 (1.41–4.65)*, 4th quartile
		Asthma severity	NS (p=0.217 for trend)
		IgE	Association (p<0.05)*, asthmatics NS (p>0.05), non-asthmatics
		Absolute eosinophil counts	Association (p<0.05)*, asthmatics NS (p>0.05), non-asthmatics
		Eosinophil cationic protein	Association (p<0.05)*, asthmatics NS (p>0.05), non-asthmatics
Grandjean et al. 2012 General population (n=456 and n=464 children 5 and 7 years of age)	1.00 ng/mL (geometric mean PFNA at age 5 years) 0.60 ng/mL (geometric mean PFNA at age 7 years)	Tetanus antibody levels at age 5	NS, maternal PFNA NS, PFNA at age 5
		Tetanus antibody levels at age 7	NS, maternal PFNA NS, PFNA at age 5
		Diphtheria antibody levels at age 5	NS, maternal PFNA β -16.1% (-28.8 to -1.0)*, per 2-fold increase PFNA levels at age 5
		Diphtheria antibody levels at age 7	NS, maternal PFNA NS, PFNA at age 5
Grandjean et al. 2017 General population (n=516 children examined at age 7 and 13 years)	1.1 and 0.7 ng/mL (median PFNA at age 7 and 13 years)	Tetanus antibody levels at age 13	NS (p=0.075), PFNA at age 7 NS (p=0.394), PFNA at age 13
		Diphtheria antibody levels at age 13	NS (p=0.243), PFNA at age 7 NS (p=0.693), PFNA at age 13
Granum et al. 2013 General population (n=56 children age 3 years)	0.3 ng/mL (mean maternal PFNA levels)	Rubella antibody levels	Inverse association (p=0.007)*
		<i>Hemophilus influenza</i> type B antibody levels	NS (p>0.05)
		Tetanus antibody levels	NS (p>0.05)
		Asthma diagnosis	NS (p>0.05)
		Atopic eczema	NS (p>0.05)
		Eczema and itchiness	NS (p>0.05)
		Number of episodes of otitis media	NS (p>0.05)

2. HEALTH EFFECTS

Table 2-16. Summary of Immunological Outcomes in Humans^a

Reference and study population ^b	Serum perfluoroalkyl level	Outcome evaluated	Result ^c
		Number of episodes of common cold	Association (p=0.035)*
		Number of episodes of gastroenteritis	NS (p=0.883)
Humblet et al. 2014	0.9 and 0.8 ng/mL (median PFNA in asthmatics and nonasthmatics)	Asthma episode in last 12 months	NS (p=0.92), per doubling PFNA
General population (NHANES) (n=1,877 adolescents)		Current asthma	NS (p=0.97)
		Wheezing	NS (p=0.94)
Kielsen et al. 2016	0.66 ng/mL (median PFNA)	Diphtheria antibody levels	Inverse association (p=0.004)*, unadjusted
General population (n=12 adults)		Tetanus antibody levels	NS (p=0.250), unadjusted
Okada et al. 2014	1.36 ng/mL (maternal mean PFNA)	Risk of allergic diseases	
General population (n=2,603 infants)		Males	OR 0.95 (0.66–1.38), 4 th quartile
		Females	OR 0.55 (0.36–0.82)*, 4th quartile
		Eczema	
		Males	OR 0.96 (0.61–1.52), 4 th quartile
		Females	OR 0.63 (0.38–1.02), 4 th quartile
Smit et al. 2015	0.62 and 0.73 ng/mL (maternal mean PFNA in Ukraine and Greenland cohorts)	Ever having asthma	OR 0.90 (0.70–1.14), whole cohort
General population (n=1,024 children)		Ever having eczema	OR 0.94 (0.78–1.14), whole cohort
		Current eczema	OR 1.03 (0.82–1.30), whole cohort
		Ever having wheezing	OR 0.91 (0.75–1.09), whole cohort
		Current wheezing	OR 0.90 (0.66–1.23), whole cohort
Stein et al. 2016a	0.765 ng/mL (geometric mean)	Measles antibody titers	NS (95% CI included unity)
General population (NHANES) (n=1,191 adolescents)		Mumps antibody titers	NS (95% CI included unity)
		Rubella antibody titers	NS (95% CI included unity)
Stein et al. 2016a	0.929 ng/mL (geometric mean)	Rhinitis	OR 1.24 (0.97–1.60)
General population (NHANES) (n=640 adolescents)		Current asthma	OR 1.26 (0.79–2.01)
		Wheeze	OR 0.99 (0.58–1.68)
		Allergy	OR 1.12 (0.85–1.47)

2. HEALTH EFFECTS

Table 2-16. Summary of Immunological Outcomes in Humans^a

Reference and study population ^b	Serum perfluoroalkyl level	Outcome evaluated	Result ^c
		Allergic sensitization	
		Plants	OR 0.96 (0.74–1.23)
		Dust mites	OR 1.05 (0.78–1.41)
		Pets	OR 1.26 (0.85–1.87)
		Cockroach or shrimp	OR 0.86 (0.60–1.24)
		Rodents	OR 2.25 (0.83–6.10)
		Mold	OR 1.31 (0.83–2.06)
		Food	OR 0.91 (0.55–1.50)
Stein et al. 2016b General pop. (n=78 adults receiving influenza vaccine)	0.77 ng/mL (geometric mean PFNA)	Seroconversion	
		Hemagglutinin	NS (p=0.33 for trend)
		Immunohistochem.	NS (p=0.40 for trend)
		Serum cytokine levels	NS (p>0.05 for trend)
		Serum chemokine levels	NS (p>0.05 for trend)
		Nasal cytokine levels	NS (p>0.05 for trend)
		Nasal chemokine levels	NS (p>0.05 for trend)
		Serum IgA levels	NS (p>0.05 for trend)
Wang et al. 2011 General population (n=244 children aged 2 years)	2.30 ng/mL (median cord PFNA)	Serum IgE levels	NS (p=0.837)
		Cord blood IgE levels	NS (p=0.908)
		Atopic dermatitis	NS (p>0.05)
Zhu et al. 2016 General population (n=231 asthmatic and 225 non-asthmatic children) This is the same group of children evaluated by Dong et al. (2013)	1.07 and 0.87 ng/mL (mean PFNA in asthmatics and non-asthmatics)	Asthma diagnosis	OR 3.33 (1.46–7.58)*, males 4th quartile NS (p=0.142 for trend), females
		T-helper cytokines	
		IL-4	Association (p=0.031 for trend)*
		IL-5	Association (p=0.011 for trend)*
		IFN- γ	NS (p>0.05 for trend)
		IL-2	NS (p>0.05 for trend)
		Serum IgE	Association (p=0.008 for trend)*

2. HEALTH EFFECTS

Table 2-16. Summary of Immunological Outcomes in Humans^a

Reference and study population ^b	Serum perfluoroalkyl level	Outcome evaluated	Result ^c
PFDeA			
Dalsager et al. 2016 General population (n=359 children aged 1–4 years)	0.27 ng/mL (median maternal serum PFDeA level)	Symptoms of infection	NS (p>0.05)
Dong et al. 2013 General population (n=231 asthmatic and 225 non-asthmatic children) This is the same group of children evaluated by Zhu et al. (2016)	1.2 and 1.0 ng/mL (mean serum PFDeA levels in the asthmatic and non-asthmatic children, respectively; serum levels were not reported for full cohort)	Asthma diagnosis	OR 3.22 (1.75–5.94)*, 4th quartile
		Asthma severity	Association (p=0.005 for trend)*
		IgE	Association (p<0.05)*, asthmatics NS (p>0.05), non-asthmatics
		Absolute eosinophil counts	Association (p<0.05)*, asthmatics NS (p>0.05), non-asthmatics
Grandjean et al. 2012 General population (n=456 and n=464 children 5 and 7 years of age)	0.28 ng/mL (geometric mean PFDeA at age 5 years)	Tetanus antibody levels at age 5	NS, maternal PFDeA β -19.9% (-33.1 to -3.9), per 2-fold increase PFDeA levels at age 5
		0.28 ng/mL (geometric mean maternal PFDeA)	Tetanus antibody levels at age 7
		Diphtheria antibody levels at age 5	NS, maternal PFDeA NS, PFDeA at age 5
		Diphtheria antibody levels at age 7	NS, maternal PFDeA NS, PFDeA at age 5
Grandjean et al. 2017 General population (n=516 children examined at age 7 and 13 years)	0.4 and 0.3 ng/mL (median at age 7 and 13 years)	Tetanus antibody levels at age 13	Association (p=0.022)*, PFDeA at age 7 NS (p=0.258), PFDeA at age 13
		Diphtheria antibody levels at age 13	Association (p=0.008)*, PFDeA at age 7 NS (p=0.726), PFDeA at age 13

2. HEALTH EFFECTS

Table 2-16. Summary of Immunological Outcomes in Humans^a

Reference and study population ^b	Serum perfluoroalkyl level	Outcome evaluated	Result ^c
Kielsen et al. 2016 General population (n=12 adults)	0.30 ng/mL (median PFDeA)	Diphtheria antibody levels	Inverse association (p=0.009)*, unadjusted
		Tetanus antibody levels	NS (p=0.130), unadjusted
Okada et al. 2014 General population (n=2,603 infants)	0.563 ng/mL (maternal mean PFDeA)	Risk of allergic diseases	
		Males	OR 1.13 (0.78–1.64), 4 th quartile
		Females	OR 0.70 (0.47–1.04), 4 th quartile
		Eczema	
Males	OR 0.93 (0.60–1.44), 4 th quartile		
Females	OR 0.78 (0.49–1.25), 4 th quartile		
Smit et al. 2015 General population (n=1,024 children)	0.16 and 0.42 ng/mL (maternal mean PFDeA in Ukraine and Greenland cohorts)	Ever having asthma	OR 0.92 (0.73–1.16), whole cohort
		Ever having eczema	OR 0.88 (0.73–1.06), whole cohort
		Current eczema	OR 0.95 (0.75–1.20), whole cohort
		Ever having wheezing	OR 0.85 (0.70–1.01), whole cohort
		Current wheezing	OR 0.76 (0.56–1.04), whole cohort
Zhu et al. 2016 General population (n=231 asthmatic and 225 non-asthmatic children) This is the same group of children evaluated by Dong et al. (2013)	1.24 and 1.02 ng/mL (mean in asthmatics and non-asthmatics)	Asthma diagnosis	OR 3.45 (1.51–7.88)*, males 4th quartile OR 3.68 (1.43–9.48)*, females 4th quartile
		T-helper cytokines	
		IL-4	NS (p>0.05 for trend)
		IL-5	NS (p>0.05 for trend)
		IFN- γ	NS (p>0.05 for trend)
		IL-2	NS (p>0.05 for trend)
		Serum IgE	Association (p=0.002 for trend)*
PFUA			
Kielsen et al. 2016 General population (n=12 adults)	0.21 ng/mL (median PFUA)	Diphtheria antibody levels	Inverse association (p=0.036)*, unadjusted
		Tetanus antibody levels	Inverse association (p=0.039)*, unadjusted

2. HEALTH EFFECTS

Table 2-16. Summary of Immunological Outcomes in Humans^a

Reference and study population ^b	Serum perfluoroalkyl level	Outcome evaluated	Result ^c
Okada et al. 2014 General population (n=2,603 infants)	1.50 ng/mL (maternal mean PFUA)	Risk of allergic diseases	
		Males	OR 1.13 (0.79–1.63), 4 th quartile
		Females	OR 0.58 (0.39–0.86)*, 4th quartile
		Eczema	
		Males	OR 1.16 (0.75–10.81), 4 th quartile
		Females	OR 0.50 (0.30–0.81)*, 4th quartile
Smit et al. 2015 General population (n=1,024 children)	0.16 and 0.68 ng/mL (maternal mean PFUA in Ukraine and Greenland cohorts)	Ever having asthma	OR 0.96 (0.77–1.21), whole cohort
		Ever having eczema	OR 0.95 (0.79–1.15), whole cohort
		Current eczema	OR 1.07 (0.85–1.34), whole cohort
		Ever having wheezing	OR 0.84 (0.70–1.00), whole cohort
		Current wheezing	OR 0.87 (0.65–1.17), whole cohort
PFHpA			
Kielsen et al. 2016 General population (n=12 adults)	0.12 ng/mL (median PFHpA)	Diphtheria antibody levels	NS (p=0.750), unadjusted
		Tetanus antibody levels	NS (p=0.280), unadjusted
Smit et al. 2015 General population (n=1,024 children)	0.03 and 0.05 ng/mL (maternal mean PFHpA in Ukraine and Greenland cohorts)	Ever having asthma	OR 0.93 (0.71–1.22), whole cohort
		Ever having eczema	OR 0.93 (0.78–1.11), whole cohort
		Current eczema	OR 0.90 (0.70–1.15), whole cohort
		Ever having wheezing	OR 1.03 (0.84–1.25), whole cohort
		Current wheezing	OR 0.62 (0.40–0.97)*, Ukraine cohort OR 1.24 (0.79–1.93), Greenland cohort OR 0.88 (0.64–1.20), whole cohort

2. HEALTH EFFECTS

Table 2-16. Summary of Immunological Outcomes in Humans^a

Reference and study population ^b	Serum perfluoroalkyl level	Outcome evaluated	Result ^c
PFBuS			
Dong et al. 2013 General population (n=231 asthmatic and 225 non-asthmatic children) This is the same group of children evaluated by Zhu et al. (2016)	0.5 and 0.5 ng/mL (mean serum PFBuS levels in the asthmatic and non-asthmatic children, respectively; serum levels were not reported for full cohort)	Asthma diagnosis	OR 1.90 (1.08–3.37)*, 4th quartile
		Asthma severity	NS (p=0.092 for trend)
		IgE	NS (p>0.05), asthmatics NS (p>0.05), non-asthmatics
		Absolute eosinophil counts	Association (p<0.05)*, asthmatics NS (p>0.05), non-asthmatics
		Eosinophil cationic protein	NS (p>0.05), asthmatics NS (p>0.05), non-asthmatics
Zhu et al. 2016 General population (n=231 asthmatic and 225 non-asthmatic children) This is the same group of children evaluated by Dong et al. (2013)	0.53 and 0.48 ng/mL (mean serum PFBuS in asthmatics and non-asthmatics)	Asthma diagnosis	OR 2.59 (1.14–5.87)*, males 4th quartile NS (p=0.505 for trend), females
		T-helper cytokines	
		IL-4	NS (p>0.05 for trend)
		IL-5	Association (p=0.023 for trend)*
		IFN- γ	NS (p>0.05 for trend)
		IL-2	NS (p>0.05 for trend)
Serum IgE	NS (p>0.05 for trend)		
PFDoA			
Dong et al. 2013 General population (n=231 asthmatic and 225 non-asthmatic children)	5.8 and 4.5 ng/mL (mean serum PFDoA levels in the asthmatic and non-asthmatic children, respectively; serum levels were not reported for full cohort)	Asthma diagnosis	OR 1.81 (1.02–3.23)*, 4th quartile
		Asthma severity	Association (p=0.024 for trend)*
		IgE	Association (p<0.05)*, asthmatics NS (p>0.05), non-asthmatics
		Absolute eosinophil counts	Association (p<0.05)*, asthmatics NS (p>0.05), non-asthmatics
		Eosinophil cationic protein	Association (p<0.05)*, asthmatics Association (p<0.05)*, non-asthmatics
Kielsen et al. 2016 General population (n=12 adults)	0.039 ng/mL (median PFDoA)	Diphtheria antibody levels	Inverse association (p=0.038)*, unadjusted
		Tetanus antibody levels	Inverse association (p=0.038)*, unadjusted

2. HEALTH EFFECTS

Table 2-16. Summary of Immunological Outcomes in Humans^a

Reference and study population ^b	Serum perfluoroalkyl level	Outcome evaluated	Result ^c
Okada et al. 2014 General population (n=2,603 infants)	0.188 ng/mL (maternal mean PFDoA)	Risk of allergic diseases	
		Males	OR 0.93 (0.65–1.34), 4 th quartile
		Females	OR 0.58 (0.39–0.85)*, 4 th quartile
		Eczema	
		Males	OR 1.00 (0.64–1.55), 4 th quartile
Females	OR 0.73 (0.45–1.18), 4 th quartile		
Smit et al. 2015 General population (n=1,024 children)	0.04 and 0.13 ng/mL (maternal mean PFDoA in Ukraine and Greenland cohorts)	Ever having asthma	OR 1.03 (0.81–1.30), whole cohort
		Ever having eczema	OR 0.90 (0.75–1.08), whole cohort
		Current eczema	OR 0.88 (0.70–1.14), whole cohort
		Ever having wheezing	OR 0.97 (0.80–1.16), whole cohort
		Current wheezing	OR 0.87 (0.64–1.18), whole cohort
PFHxA			
Dong et al. 2013 General population (n=231 asthmatic and 225 non-asthmatic children)	0.3 and 0.2 ng/mL (mean serum PFHxA levels in the asthmatic and non-asthmatic children, respectively; serum levels were not reported for full cohort)	Asthma diagnosis	OR 1.60 (0.90–2.86), 4 th quartile
		Asthma severity	NS (p=0.854)
		IgE	NS (p>0.05), asthmatics NS (p>0.05), non-asthmatics
		Absolute eosinophil counts	NS (p>0.05), asthmatics NS (p>0.05), non-asthmatics
		Eosinophil cationic protein	NS (p>0.05), asthmatics NS (p>0.05), non-asthmatics

^aSee the *Supporting Document for Epidemiological Studies for Perfluoroalkyls*, Table 10 for more detailed descriptions of studies.

^bParticipants in occupational exposure may have also lived near the site and received residential exposure; community exposure studies involved subjects living near PFOA facilities with known exposure to high levels of PFOA.

^cAsterisk and bold indicates association with perfluoroalkyl compound; unless otherwise specified, values in parenthesis are 95% confidence intervals.

CI = confidence interval; IFN- α 2 = interferon- α 2; IFN- γ = interferon- γ ; IgA = immunoglobulin A; IgE = immunoglobulin E; IP-10 = interferon- γ -inducible protein 10; IRR= incidence risk ratio; NHANES = National Health and Nutrition Examination Survey; NR = not reported; NS = not significant; OR = odds ratio; PFBuS = perfluorobutane sulfonic acid; PFDeA = perfluorodecanoic acid; PFDoA = perfluorododecanoic acid; PFHpA = perfluoroheptanoic acid; PFHxS = perfluorohexane sulfonic acid; PFNA = perfluorononanoic acid; PFOA = perfluorooctanoic acid; PFOS = perfluorooctane sulfonic acid; PFUA = perfluoroundecanoic acid; RR= relative risk; TNF- α =tumor necrosis factor- α

2. HEALTH EFFECTS

have examined secondary outcomes (lymphoid organ weights, lymphocyte counts or subpopulations, lymphocyte proliferation, cytokine levels, serum antibody levels, histological alterations in immune organs). Summaries of the laboratory animal studies are presented in the LSE tables for PFOA, PFOS, and other perfluoroalkyls (Tables 2-3, 2-4, 2-5, and 2-6); the NOAEL and LOAEL values are presented in Figures 2-6, 2-7, and 2-8. Studies in laboratory animals identify the immune system as a sensitive target of toxicity following exposure to PFOA and PFOS. The observed effects include impaired responses to T-dependent antigens, impaired response to infectious disease, and secondary outcomes (decreases in spleen and thymus weights and in the number of thymic and splenic lymphocytes). A small number of studies evaluated the immunotoxicity of other perfluoroalkyls and most did not evaluate immune function. No alterations in spleen or thymus organ weights or morphology were observed in studies on PFHxS, PFBA, and PFDeA. A study on PFNA found decreases in spleen and thymus weights and alterations in splenic lymphocyte phenotypes.

The National Toxicology Program (NTP 2016b) concluded that exposure to PFOA or PFOS is presumed to be an immune hazard to humans based on a high level of evidence that PFOA and PFOS suppressed the antibody response from animals and a moderate level of evidence from studies in humans. It was noted that the strongest evidence is for suppression of the antibody response and increased hypersensitivity (PFOA only).

PFOA

Epidemiology Studies—Immunosuppression Outcomes. Studies evaluating the immunosuppressive effects of PFOA have examined disease resistance and antibody responses. One study found associations between maternal serum PFOA and the number of episodes of the common cold and other respiratory tract infections and the number of episodes of gastroenteritis with vomiting or diarrhea in 3-year-old children (Granum et al. 2013). Another study found an association between maternal PFOA and the risk of having a greater number of days with a fever greater than the median (Dalsager et al. 2016), although there was no increase in the number of days with a fever. However, other studies have not found associations between PFOA levels and the frequency of the common cold or flu in adults (Looker et al. 2014), between maternal PFOA levels and otitis media in 1.5–3-year-old children (Granum et al. 2013; Okada et al. 2012), between maternal PFOA and the risk of hospitalization for infectious diseases in young children (Fei et al. 2010), or between maternal PFOA and the risk of number of days with cough, nasal discharge, diarrhea, or vomiting (Dalsager et al. 2016).

2. HEALTH EFFECTS

Several studies have evaluated the antibody response to vaccination in adults and children; the changes in the response to antibody levels relative to serum PFOA levels are graphically presented in Figure 2-19. In adults, decreases in antibody response against influenza A H3N2 virus were associated with increasing serum PFOA levels; however, there were no associations with two other strains of influenza virus (influenza A H1N1 and influenza B) (Looker et al. 2014). Another study of adults also did not find an altered immune response to influenza A H1N1 virus (Stein et al. 2016b). A small-scale study of 12 adults did not find significant alterations in the response to diphtheria or tetanus booster vaccines associated with serum PFOA levels (Kielsen et al. 2016). Increasing current serum PFOA levels were associated with lower antibody levels for mumps and rubella, but not for measles, in a cross-sectional study of adolescents (Stein et al. 2016a). A series of prospective studies by Grandjean and associates (Grandjean et al. 2012, 2017; Mogensen et al. 2015a) evaluated tetanus and diphtheria antibody levels in children at 5, 7, and 13 years of age. Diphtheria antibody levels at age 7 and 13 were inversely associated with serum PFOA levels at age 5 and 7 (Grandjean et al. 2012; Mogensen et al. 2015a) and with serum PFOA at age 13 (Grandjean et al. 2017), respectively. Decreases in tetanus antibody levels at age 7 were associated with increases in serum PFOA levels at age 5, but not at age 7 (Grandjean et al. 2012; Mogensen et al. 2015a) and tetanus antibody levels were not associated with serum PFOA at age 7 or 13 (Grandjean et al. 2017). In studies comparing maternal serum PFOA with antibody levels in children, no associations were found for tetanus antibodies at age 3 (Granum et al. 2013), age 5 (Grandjean et al. 2012), or age 7 (Grandjean et al. 2012) or for diphtheria at age 5 or 7 (Grandjean et al. 2012). It is noted that Grandjean and associates also found an inverse association between serum polychlorinated biphenyls (PCBs) and serum antibody concentrations against tetanus and diphtheria in children living in the Faroe Islands (Heilmann et al. 2010). Lower levels of rubella antibodies at age 3 were associated with increasing maternal PFOA (Granum et al. 2013).

NTP (2016b) concluded that there is moderate confidence that exposure to PFOA is associated with suppression of the antibody response based on the available human studies. NTP (2016b) also concluded that there is low confidence that exposure to PFOA is associated with increased incidence of infectious disease (or lower ability to resist or respond to infectious disease).

Epidemiology Studies—Hypersensitivity Outcomes. Of the different types of hypersensitivity effects, the most widely studied endpoint is asthma; the possible association between exposure to PFOA and asthma has been studied in occupational, community, and general population studies. Several studies have found associations between current serum PFOA levels and diagnosis of asthma in children (Dong et al. 2013; Humblet et al. 2014) and adults (Anderson-Mahoney et al. 2008; Zhu et al. 2016).

2. HEALTH EFFECTS

Figure 2-19. Antibody Responses Relative to Serum PFOA Levels in Epidemiology Studies
 (Presented as percent difference in antibody concentration per 2-fold increase in serum PFOA)

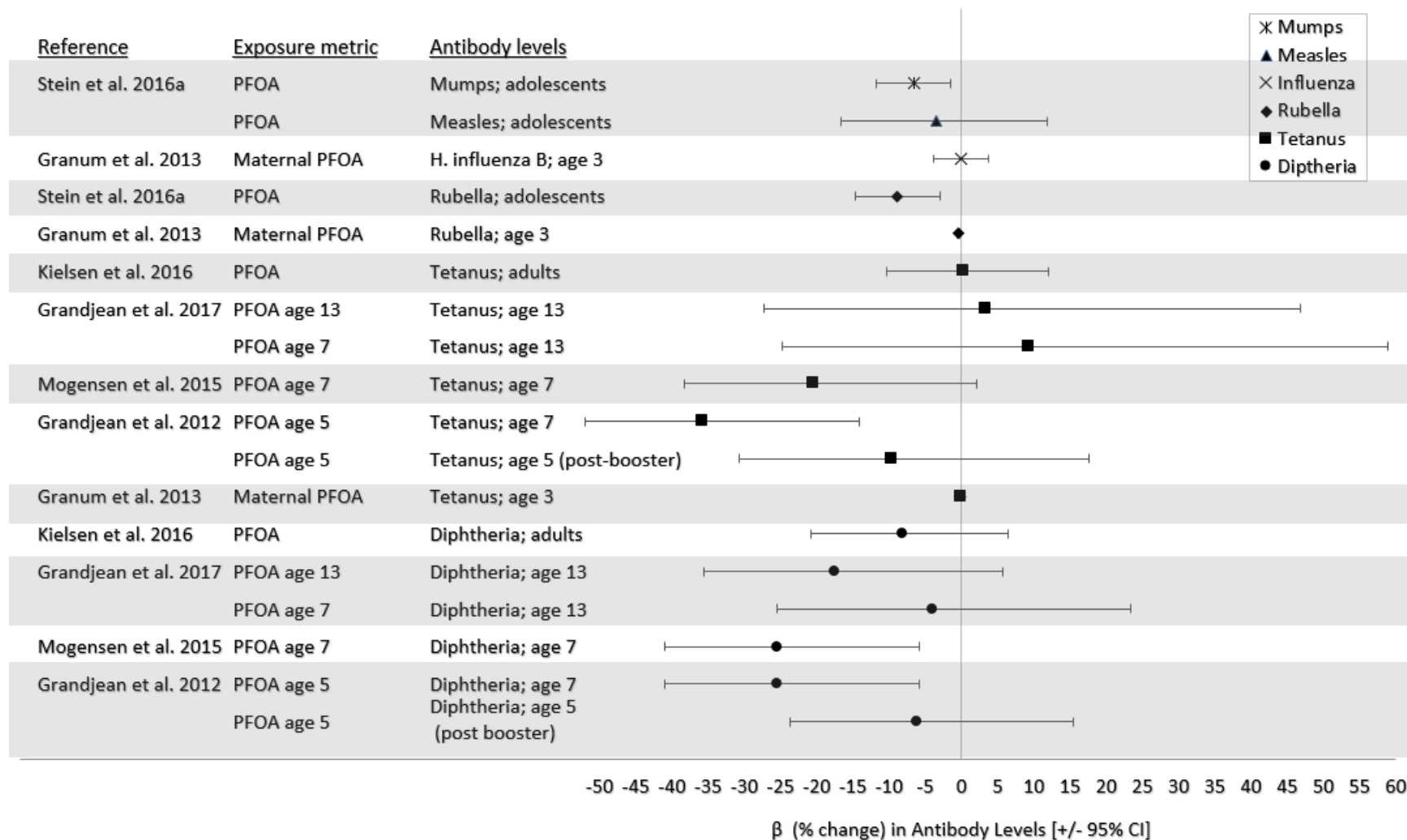

2. HEALTH EFFECTS

However, other studies have found no association between estimated cumulative serum PFOA levels and incidence of asthma being treated with medication in workers (Steenland et al. 2015) or asthma in the general population (Stein et al. 2016a). In children, no associations between maternal serum PFOA levels and asthma-related health outcomes were observed in 3-year-old children (Granum et al. 2013) or 5–9-year-old children (Smit et al. 2015), or between current PFOA levels and current asthma in adolescents (Stein et al. 2016a). However, the Stein et al. (2016a) study did find an association with rhinitis in adolescents. No associations between maternal PFOA and wheezing were found in infants up to 18 months of age (Okada et al. 2012), infants 12 or 24 months of age (Okada et al. 2014), children 3 years of age (Granum et al. 2013), or children 5–9 years of age (Smit et al. 2015) or between current serum PFOA levels and wheezing in adults (Stein et al. 2016a). The ORs for asthma diagnosis relative to serum PFOA levels are graphically presented in Figure 2-20. No associations between maternal PFOA and eczema were found in infants up to 18 months of age (Okada et al. 2012), children 3 years of age (Granum et al. 2013), or children 5–9 years of age (Smit et al. 2015). Similarly, no association was found between cord blood PFOA and atopic dermatitis in children 2 years of age (Wang et al. 2011).

No association between current serum PFOA levels and risks of allergy or allergic sensitization were found in adults (Stein et al. 2016a). Two studies examining the possible association between current serum PFOA levels in adults and food allergies have found mixed results, with one study finding an association (Buser and Scinicariello 2016) and one not finding an association (Stein et al. 2016a); a study in infants did not find an association between the risk of food allergy and maternal serum PFOA levels (Okada et al. 2012). It is noted that IgE levels, which were used to assess food allergies, is not a sensitive measure of clinical food allergy. No association was found for food sensitization (Buser and Scinicariello 2016).

Associations between serum PFOA and IgE, eosinophil counts, and eosinophil cationic protein levels were observed in asthmatic children (9–16 years of age), but not in non-asthmatic children (Dong et al. 2013; Zhu et al. 2016). Significantly higher IL-4 and IL-5 levels were observed in male children with asthma with the highest PFOA levels (Zhu et al. 2016). Two studies found associations between PFOA and IgE levels in infants. An inverse association was found between maternal PFOA and IgE levels in female infants but not in male infants (Okada et al. 2012), whereas Wang et al. (2011) found a correlation between cord blood PFOA and child IgE levels in males only or in males and females combined. A third study did not find an association between cord blood PFOA and IgE levels in infants (Ashley-Martin et

2. HEALTH EFFECTS

Figure 2-20. Risk of Asthma Diagnosis Relative to PFOA Levels (Presented as Adjusted Odds Ratios)

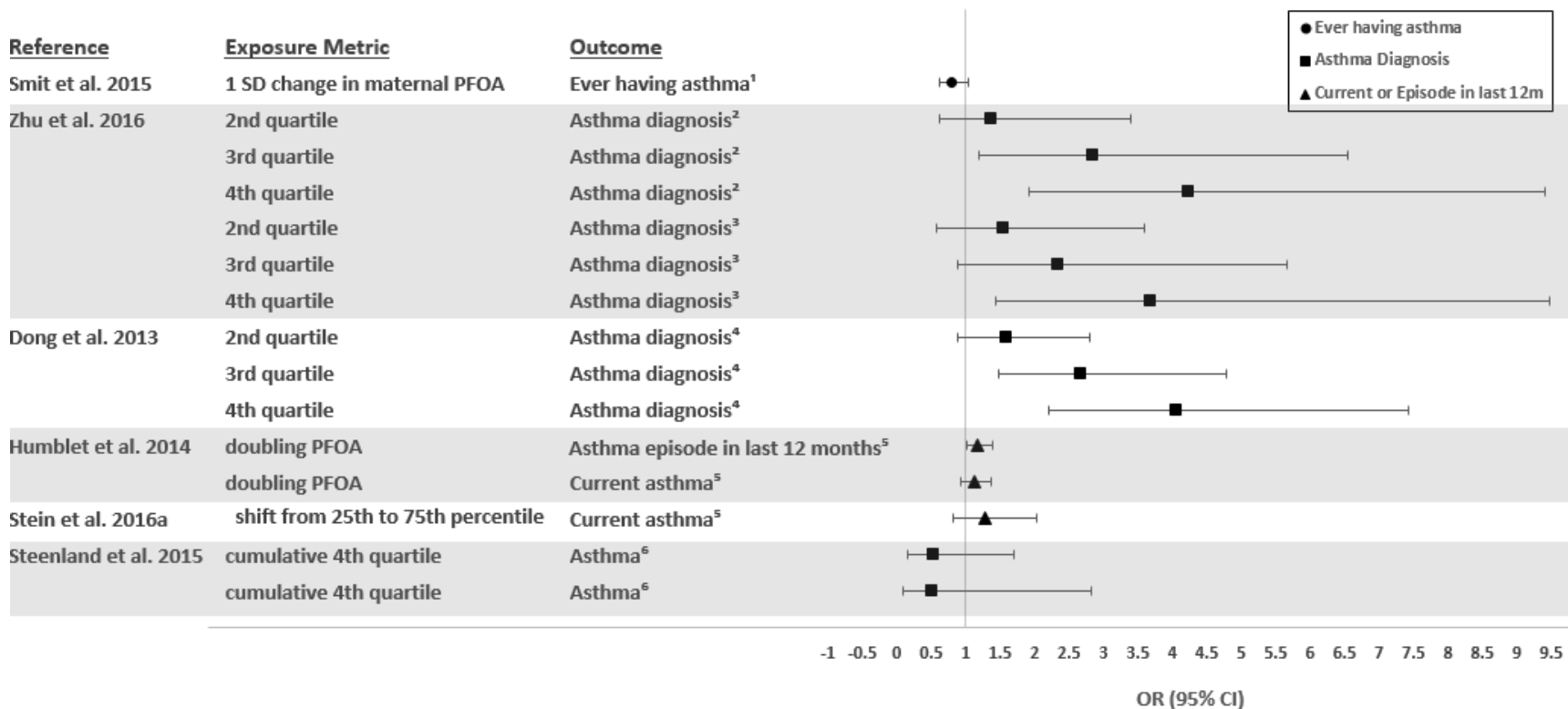

¹age 5–9 years
²males, age 9–16 years
³females age 9–16 years
⁴age 10–15 years
⁵age 12–19 years
⁶adult

2. HEALTH EFFECTS

al. 2015). NTP (2016b) concluded that there is low confidence that exposure to PFOA during childhood is associated with increased hypersensitivity responses.

Associations between serum PFOA and IgE, eosinophil counts, and eosinophil cationic protein levels were observed in asthmatic children (9–16 years of age), but not in non-asthmatic children (Dong et al. 2013; Zhu et al. 2016). Significantly higher IL-4 and IL-5 levels were observed in male children with asthma with the highest PFOA levels (Zhu et al. 2016). Two studies found associations between PFOA and IgE levels in infants. An inverse association was found between maternal PFOA and IgE levels in female infants but not in male infants (Okada et al. 2012), whereas Wang et al. (2011) found a correlation between cord blood PFOA and child IgE levels in males only or in males and females combined. A third study did not find an association between cord blood PFOA and IgE levels in infants (Ashley-Martin et al. 2015). NTP (2016b) concluded that there is low confidence that exposure to PFOA during childhood is associated with increased hypersensitivity responses.

Epidemiology Studies—Autoimmune Outcomes. There are limited data that can be used to evaluate the possible association between PFOA exposure and the risk of autoimmune diseases. Significant increases in the risk of ulcerative colitis were observed in an occupational exposure study (Steenland et al. 2015) and a C8 Science Panel study (Steenland et al. 2013). Although both studies found consistent results, it should be noted that the community study also included participants with occupational exposure to PFOA. The occupational study also found an association between PFOA exposure and rheumatoid arthritis; this was not observed in the community study. The community study (Steenland et al. 2013) also found no associations for other autoimmune diseases (Crohn’s disease, Type I diabetes, lupus, and multiple sclerosis). A third study examined neural- and non-neural-specific antibodies and found no associations with cord blood PFOA or current serum PFOA in 7-year-old children (Osuna et al. 2014).

NTP (2016b) concluded that there is low confidence that exposure to PFOA is associated with ulcerative colitis.

Laboratory Animal Studies. The results of several mouse studies support the epidemiology data suggesting that exposure to PFOA can result in immunosuppression. Significant alterations in IgM levels in response to T-dependent antigens, such as sheep red blood cells (sRBCs) or horse red blood cells were observed in acute and intermediate oral mouse studies (DeWitt et al. 2008, 2009, 2016; Loveless et al. 2008; Yang et al. 2002a); the lowest-adverse-effect level was 3.75 mg/kg/day in mice exposed to PFOA in the drinking water for 15 days (DeWitt et al. 2008). Rats appear to be less sensitive than mice; no

2. HEALTH EFFECTS

alterations in IgM levels were observed rats administered PFOA via gavage for 28 days (Loveless et al. 2008). In a mouse developmental toxicity study, exposure to PFOA on GDs 6–17 was not associated with alterations in IgM or IgG levels in the offspring (Hu et al. 2010). Limited data suggest that alterations in NK cells or delayed type hypersensitivity are not sensitive endpoints for PFOA in laboratory animals. Exposure of male rats to 50 mg/kg/day PFOA by gavage for 14 days did not significantly affect the numbers of T cells, NK cells, or helper T cells (Iwai and Yamashita 2006), and tests for delayed-type hypersensitivity response in mice challenged with bovine serum albumin following exposure to 30 mg/kg/day PFOA via drinking water for 15 days were negative (DeWitt et al. 2008).

Two studies have evaluated hypersensitivity in mice. Application of ≥ 18.8 mg/kg/day PFOA to the dorsal surface of the ears of mice and subsequently injected with ovalbumin resulted in a significant increase in serum total IgE compared to mice exposed only to ovalbumin (Fairley et al. 2007). Ovalbumin-specific airway hyperreactivity also increased in mice co-exposed to ovalbumin and 25 mg/kg PFOA relative to mice exposed to ovalbumin alone. The investigators suggested that PFOA exposure may increase the IgE response to environmental allergens (Fairley et al. 2007). In contrast to the results of the dermal study, no increases in airway hyperresponsiveness were observed in ovalbumin-sensitized mice exposed *in utero* and post-weaning to PFOA in the diet (Ryu et al. 2014). In nonsensitized mice, PFOA did induce airway hyperresponsiveness in 12-week-old pups.

Numerous studies have evaluated secondary outcomes in monkeys, rats, and mice. In the spleen and thymus, exposure to PFOA resulted in decreases in organ weight, decreases in the number of cells, and/or atrophy (DeWitt et al. 2008; Loveless et al. 2008; Qazi et al. 2009a, 2012; Son et al. 2009; Yang et al. 2000, 2001, 2002b). Acute exposure resulted in decreases in absolute thymus weight at 11.5 mg/kg/day (Yang et al. 2001), decreases in spleen weight at 30 mg/kg/day (Qazi et al. 2012; Yang et al. 2000), and severe thymic atrophy at 30 mg/kg/day (Qazi et al. 2012; Yang et al. 2000). Exposure of male rats to 50 mg/kg/day PFOA by gavage for 14 days did not significantly affect the absolute or relative spleen weight nor did it alter lymphocyte subsets (Iwai and Yamashita 2006).

Decreases in relative spleen weight were observed at ≥ 0.96 mg/kg/day PFOA, and absolute spleen weight and absolute and relative thymus weights were decreased at 9.6 and 29 mg/kg/day (Loveless et al. 2008). The lowest-adverse-effect levels for spleen and thymus weight changes identified in mouse intermediate studies were 3.75 mg/kg/day PFOA for decreases in absolute spleen weight (DeWitt et al. 2008) and 9.6 mg/kg/day for decreases in absolute and relative thymus weight (Loveless et al. 2008). In rats, no

2. HEALTH EFFECTS

alterations in spleen weight were observed following chronic exposure to 15 mg/kg/day in the diet (3M 1983).

Decreases in the number of splenic and thymic lymphocytes were observed in mice administered via gavage ≥ 9.6 mg/kg/day PFOA for 28 days (Loveless et al. 2008). In contrast, administration of 29 mg/kg/day PFOA by gavage for 28 days did not result in alterations in the number of splenic or thymic lymphocytes in rats (Loveless et al. 2008). A 10-day exposure of mice to 3.0 mg/kg/day PFOA resulted in decreases in the number of bone marrow B-lymphoid cells (Qazi et al. 2012); a decrease in bone marrow myeloid cells was also observed at 30 mg/kg/day. Examination of the B-lymphoid cell subpopulations showed decreases in pro/pre B cells, immature B cells, and early mature B cells, with the greatest reductions observed for pro/pre B cells. When mice were allowed to recover for 10 days following a 10-day exposure to 30 mg/kg/day PFOA in the diet, only a partial recovery of B-lymphoid cells was observed. Significant increases in CD4-CD8- and CD4-CD8+ thymic lymphocytes were observed in mice exposed to 47.21 mg/kg/day for 21 days; increases in CD4+CD8+ lymphocytes were observed at 17.63 and 47.21 mg/kg/day (Son et al. 2009). Similarly, there were decreases in splenic CD4-CD8- lymphocytes at 47.21 mg/kg/day and CD4-CD8+ lymphocytes at ≥ 0.49 mg/kg/day and increases in splenic CD4+CD8- lymphocytes at 17.63 and 47.21 mg/kg/day.

Two studies examined the immune response to mitogens in mice exposed to PFOA. Marked decreases in total leukocytes, lymphocytes, and neutrophils levels and increases in tumor necrosis factor- α (TNF- α) and interleukin-6 (IL-6) were observed in the peritoneal cavity, bone marrow, and spleen cells in response to lipopolysaccharide (LPS) stimulation in mice exposed to approximately 40 mg/kg/day PFOA for 10 days (Qazi et al. 2009a). Exposure of splenic lymphocytes isolated from PFOA-exposed mice to concavalin A (ConA) or LPS resulted in decreases in lymphocyte proliferation (Yang et al. 2002a).

A number of studies have evaluated the potential of PFOA to induce histological alterations in immune organs. In monkeys, administration of approximately 20 mg/kg/day PFOA administered via a capsule to Cynomolgus monkeys for 4 or 26 weeks did not affect the gross or microscopic morphology of the spleen (Butenhoff et al. 2002; Thomford 2001). Administration via gavage of 30 mg/kg/day PFOA to Rhesus monkeys for 90 days induced atrophy of lymphoid follicles in the spleen and lymph nodes and slight to moderate hypocellularity of the bone marrow (Griffith and Long 1980). No histological alterations were observed in the spleen or thymus of rats exposed intermittently to ≤ 84 mg/m³ APFO dusts for 2 weeks (Kennedy et al. 1986), ≤ 29 mg/kg/day administered via gavage for 28 days (Loveless et al. 2008), or dermal doses of ≤ 2000 mg/kg/day for 2 weeks (Kennedy 1985) or in the spleen and mesenteric lymph

2. HEALTH EFFECTS

nodes of rats exposed to ≤ 110 mg/kg/day PFOA in the diet for 90 days (Griffith and Long 1980) or ≤ 15 mg/kg/day PFOA in the diet for 2 years (3M 1983).

Studies in wild-type mice and PPAR α -null mice demonstrate that PFOA-induced immunomodulation results from PPAR α -dependent and -independent mechanisms (DeWitt et al. 2016; Yang et al. 2002b). Exposure to 30 or 33 mg/kg/day PFOA resulted in decreases in spleen weight, thymus weight, number of splenic lymphocytes, number of thymic lymphocytes, and CD4+ and CD8+ splenic and thymic lymphocytes in wild-type mice. Similar exposures of PPAR α knockout mice did not result in alterations in spleen weight, number of splenic lymphocytes, or their phenotypes. Although decreases in thymus weight, number of thymic lymphocytes, and their phenotypes were observed in the knockout mice, the magnitudes of the changes were lower in the knockout mice than in the wild-type mice. However, similar responses were observed in T-cell-dependent antibody responses. Exposure to 30 mg/kg/day PFOA resulted in 16 and 14% decreases in the response to sRBCs in wild-type and knockout mice, respectively (DeWitt et al. 2016).

In a systematic review of the available laboratory animal data, NTP (2016b) concluded that there is high confidence that exposure to PFOA is associated with suppression of the antibody response, very low confidence that PFOA is associated with the ability to respond to infectious disease, and moderate confidence that PFOA is associated with increased hypersensitivity.

Summary. Epidemiology studies have evaluated several aspects of immunotoxicity including immunosuppression, hypersensitivity, and autoimmunity. A number of general populations studies have found significant inverse associations between serum PFOA levels and antibody responses to vaccines. However, no consistent associations were found between serum PFOA and disease resistance, as measured by episodes of the common cold, cough, fever, or hospitalization for infectious disease. In tests of hypersensitivity, there is some evidence of an association between serum PFOA and asthma diagnosis in children and adults, although this finding was not consistent across studies; increased risk of allergy or allergic sensitization does not appear to be associated with serum PFOA. Based on the findings of an occupational exposure and community exposure study, there is some suggestive association between serum PFOA and an increased risk of ulcerative colitis, but not for other autoimmune diseases. Animal studies suggest that the immune system is a sensitive target of PFOA toxicity. A number of studies in mice have demonstrated evidence of immunosuppression and increased hypersensitivity. Laboratory animal studies have also found secondary immune outcomes in the spleen and thymus, which included decreases in organ weight and decreases in the number of lymphocytes.

2. HEALTH EFFECTS

PFOS

Epidemiology Studies—Immunosuppression Outcomes. Several epidemiology studies have evaluated the potential of PFOS to cause immunosuppression. In studies that evaluated infectious disease resistance, no alterations in the risk of otitis media were observed in infants monitored through 18 months or 3 years of age (Granum et al. 2013; Okada et al. 2012), common cold or other upper respiratory infections (Granum et al. 2013), gastroenteritis with vomiting or diarrhea (Granum et al. 2013), hospitalizations due to infectious diseases in children (Fei et al. 2010), or symptoms of infection such as nasal discharge, cough, diarrhea, or vomiting in children (Dalsager et al. 2016). However, associations between the number of days with symptoms of infection and maternal PFOS levels were observed in children (Dalsager et al. 2016).

Other studies evaluating immunosuppression found significant alterations in the response to vaccines; the changes in the response to antibody levels relative to serum PFOS levels are graphically presented in Figure 2-21. In children receiving a tetanus vaccination at age 5, there were associations between serum PFOS levels at age 5 and tetanus antibody levels at age 5 (Grandjean et al. 2012) and between serum PFOS levels at age 7 and tetanus antibody levels at age 7 when the analysis was restricted to children who were not likely to have had a booster vaccine after age 5 (Grandjean and Budtz-Jorgensen 2013). However, no associations were found between tetanus antibody levels at age 5 and maternal PFOS or child PFOS levels (Grandjean et al. 2012), between tetanus antibody levels at age 7 and maternal PFOS or child PFOS levels at age 5 or 7 (Grandjean et al. 2012; Mogensen et al. 2015a), or between tetanus antibody levels at age 14 and child PFOS levels at age 13 (Grandjean et al. 2017). Similarly, diphtheria antibody levels at age 7 were significantly associated with serum PFOS levels at age 5 and 7 (Grandjean et al. 2012; Mogensen et al. 2015a), but antibody levels at age 5 were not associated with maternal PFOS or child PFOS at age 5 (Grandjean et al. 2012) and antibody levels at age 13 were not associated with child PFOS levels at age 7 or 13 (Grandjean et al. 2017). In another study of children (Granum et al. 2013), decreased rubella antibody levels were associated with higher maternal PFOS levels, but no associations were found for tetanus or Haemophilus influenza type B antibodies. In adolescents, recent serum PFOS levels were inversely associated with mumps and rubella antibody levels, but not with measles antibody levels (Stein et al. 2016a). In studies in adults, recent PFOS levels were inversely associated with diphtheria antibody levels 30 days after booster administration (Kielsen et al. 2016), but not with tetanus antibody levels 30 days after booster administration (Kielsen et al. 2016) or influenza types A H3N2, A H1N1, or B antibody levels 21 days post-vaccination (Looker et al. 2014).

2. HEALTH EFFECTS

Figure 2-21. Antibody Responses Relative to Serum PFOS Levels in Epidemiology Studies
 (Presented as percent difference in antibody concentration per 2-fold increase in serum PFOS)

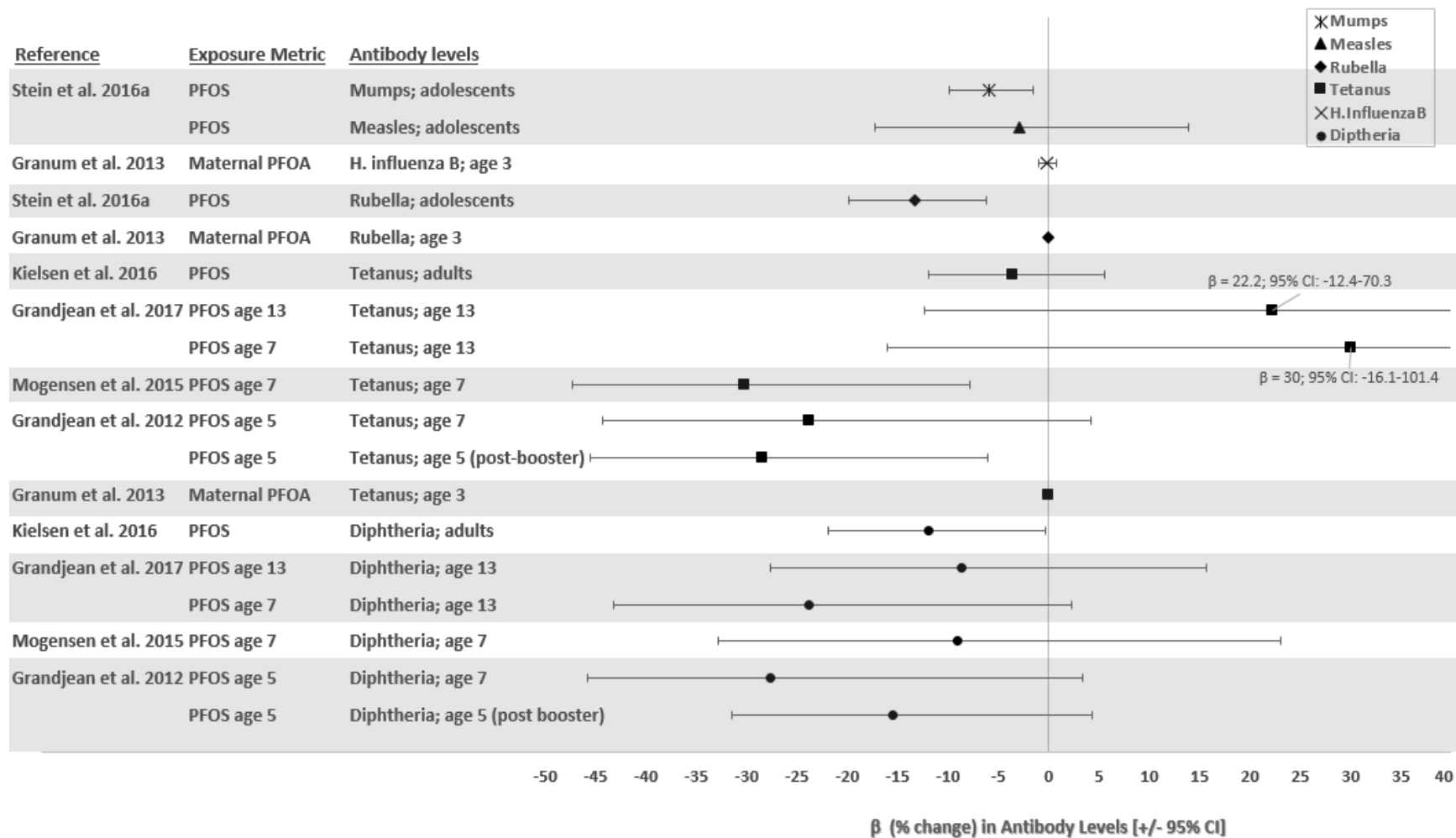

2. HEALTH EFFECTS

NTP (2016b) concluded that there is moderate confidence that exposure to PFOS is associated with suppression of the antibody response and that there is low confidence that exposure to PFOS is associated with increased incidence of infectious disease (or lower ability to resist or respond to infectious disease).

Epidemiology Studies—Hypersensitivity Outcomes. Several studies examined the risk of hypersensitivity associated with serum PFOS in children and adolescents; however, the results are inconsistent. In two case-control studies, increased risks of asthma were observed. Dong et al. (2013) reported an increased risk of asthma diagnosis and increased severity of asthma episodes in children with PFOS levels in the 4th quartile. Zhu et al. (2016) also reported an association between asthma diagnosis and serum PFOS levels in the 4th quartile; however, the association was only significant in males. Prospective and cross-sectional studies in children (Granum et al. 2013) did not find an association between maternal PFOS levels and the risk of asthma diagnosis in 3 year olds, between maternal PFOS and asthma diagnosis in children in adolescence (Humblet et al. 2014; Stein et al. 2016a). Data evaluating associations between serum PFOS and the risk of asthma diagnosis are presented in Figure 2-22.

No associations between maternal PFOS and eczema, atopic dermatitis, or wheezing have been found in children (Granum et al. 2013; Okada et al. 2012, 2014; Smit et al. 2015; Wang et al. 2011). Similarly, no associations between recent serum PFOS levels in adolescents and food allergies or sensitizations (Buser and Scinicariello 2016; Stein et al. 2016a) or maternal PFOS levels and food allergies in infants (Okada et al. 2012) were observed. However, in a cross-sectional study of adolescents, recent PFOS levels were associated with mold allergies and inversely associated with the risk of plant or cockroach or shrimp allergies (Stein et al. 2016a). In related studies, cord blood PFOS levels were associated with an increase in cord IgE levels, but not in infant serum IgE levels (Wang et al. 2011). Two other studies did not find associations between maternal PFOS levels and cord IgE levels (Ashley-Martin et al. 2015; Okada et al. 2012).

NTP (2016b) concluded that there is very low confidence that exposure to PFOS is associated with changes in the hypersensitivity response in children.

Laboratory Animal Studies. A limited number of laboratory animal studies examined PFOS-induced immunosuppression. Guruge et al. (2009) reported an impaired response to an influenza A virus challenge in mice administered 0.025 mg/kg/day PFOS via gavage for 21 days (Guruge et al. 2009). Several studies have found an impaired response to sRBCs (Dong et al. 2009, 2011; Peden-Adams et al.

2. HEALTH EFFECTS

Figure 2-22. Risk of Asthma Diagnosis Relative to PFOS Levels (Presented as Adjusted Odds Ratios)

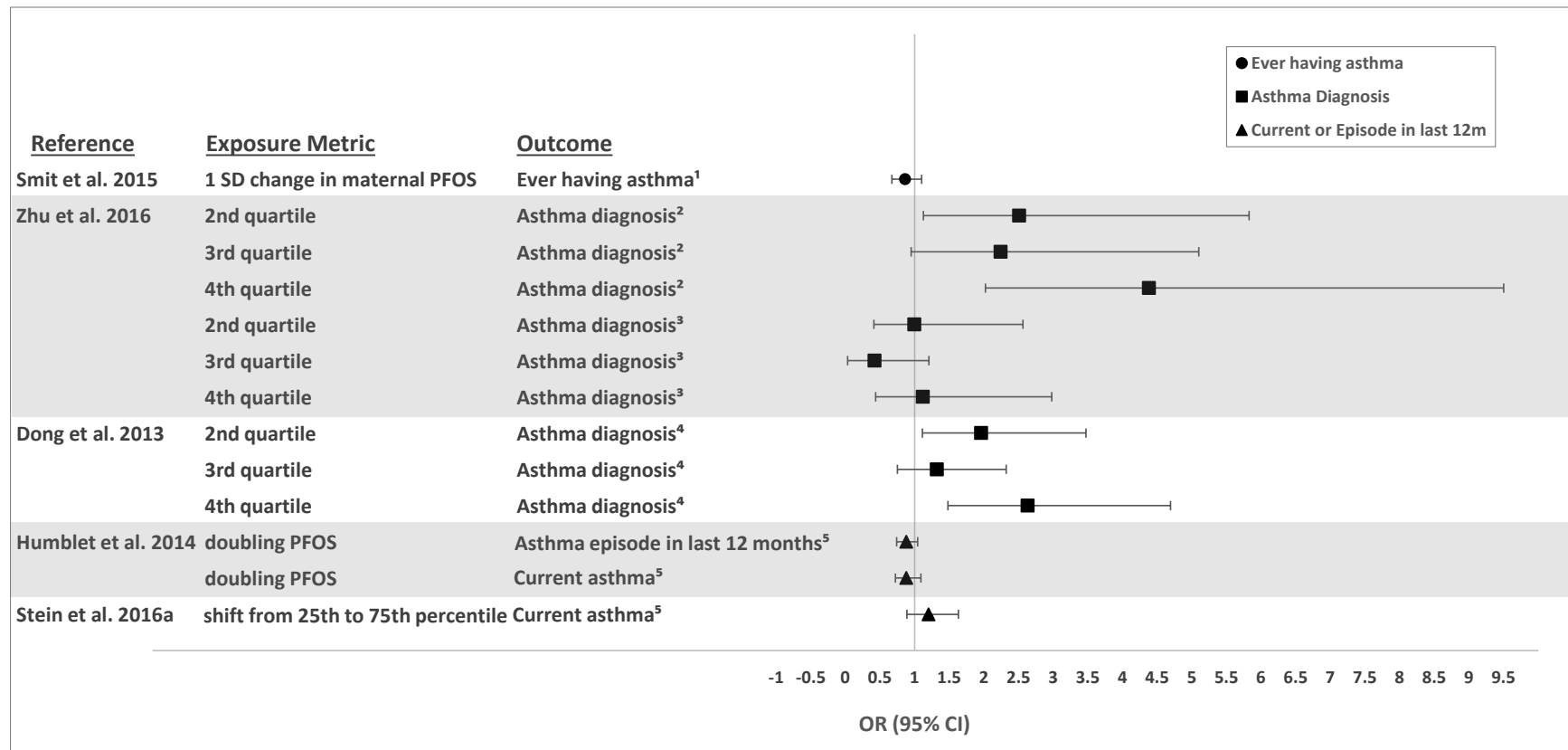

¹age 5–9 years
²males, age 9–16 years
³females age 9–16 years
⁴age 10–15 years
⁵age 12–19 years

2. HEALTH EFFECTS

2008); however, decreases in NK cell activity were observed at higher doses (0.83–2.08 mg/kg/day) (Dong et al. 2009). Qazi et al. (2009a) reported several alterations in parameters associated with the innate immune system in mice exposed to approximately 40 mg/kg/day PFOS in the diet for 10 days. These alterations included marked decreases in total leukocyte and lymphocyte levels and increases in TNF- α and IL-6 levels in the peritoneal cavity and bone marrow in response to LPS stimulation; no alterations were observed in mice exposed to a 20-fold lower dose.

No alterations in spleen or thymus weights were observed in mice exposed to 0.025 mg/kg/day PFOS (Guruge et al. 2009); at a higher dose (0.42 mg/kg/day), significant decreases in relative spleen and thymus weights were observed (Dong et al. 2009; Zheng et al. 2009). Decreases in splenic and thymic cellularity were also observed at ≥ 0.42 mg/kg/day PFOS (Dong et al. 2009; Qazi et al. 2009b, 2012; Zheng et al. 2009). Bone marrow cells (B-lymphoid and myeloid cells) were also significantly decreased in mice exposed to 30 mg/kg/day PFOS for 10 days (Qazi et al. 2012). Within the B-lymphoid cell population, there were decreases in the number of pro/pre B cells and immature cells (Qazi et al. 2012). Significant alterations in all splenic T cell CD4 and CD8 subpopulations were observed at ≥ 0.00331 mg/kg/day PFOS (Peden-Adams et al. 2008) and thymic lymphocyte phenotypes were altered at 0.42 mg/kg/day PFOS (Dong et al. 2009).

Rats treated with 1.77 mg/kg/day PFOS for 4 weeks, 6.34 mg/kg/day for 28 days, 1.56 mg/kg/day for 14 weeks, or 1.04 mg/kg/day for 2 years did not show significant morphological alterations in the spleen, thymus, or mesenteric lymph nodes (Butenhoff et al. 2012b; Lefebvre et al. 2008; Seacat et al. 2003; Thomford 2002b). Similar findings were reported in Cynomolgus monkeys dosed with up to 2 mg/kg/day for 4 weeks or up to 0.75 mg/kg/day PFOS for 26 weeks (Seacat et al. 2002; Thomford 2002a).

In a systematic review of the available laboratory animal data, NTP (2016b) concluded that there is high confidence that exposure to PFOS is associated with suppression of the antibody response, moderate confidence that PFOS is associated with the ability to respond to infectious disease, and low confidence that PFOS is associated with increased hypersensitivity.

Summary. A number of epidemiology studies have examined the potential immunotoxicity of PFOS. The database provides convincing evidence of an association between serum PFOS levels and immunosuppression, particularly impaired antibody responses to vaccines in adults and children. Mixed results have been observed in studies evaluating infectious disease resistance. Similarly, inconsistent

2. HEALTH EFFECTS

results have been examined in studies evaluating associations between serum PFOS and hypersensitivity outcomes, such as asthma; no associations were found for eczema, dermatitis, food allergies/sensitizations. Laboratory animal studies, particularly studies in mice, provide strong evidence of the immunotoxicity of PFOS. The strongest evidence comes from studies reported impaired antibody responses resulting in oral exposure to relatively low doses of PFOS. Other immune effects include decreased response to infectious disease, decreases in spleen and thymus weights, and decreases in splenic and thymic cellularity and bone marrow cells.

PFHxS

Epidemiology Studies—Immunosuppression Outcomes. Several epidemiology studies have examined the potential of PFHxS to suppress the immune system. Altered antibody responses relative to serum PFHxS levels are graphically presented in Figure 2-23. Inverse associations were observed between tetanus antibody levels in 5 and 7 year olds and serum PFHxS levels at age 5 or 7 years (Grandjean et al. 2012; Mogensen et al. 2015a); but there were no associations between serum PFHxS levels at age 7 or 13 and tetanus antibody levels at age 13 (Grandjean et al. 2017). No associations were found between maternal PFHxS levels and tetanus antibody levels in the children. These studies found no associations between diphtheria antibody levels at ages 5, 7, or 13 and serum PFHxS levels in the mother or in the children. A study in 3-year-old children found an inverse association between maternal PFHxS levels and rubella antibody levels, but no association with influenza type B or tetanus antibody levels (Granum et al. 2013). In adolescents, serum PFHxS levels were also inversely associated with rubella antibody titers in a seropositive subcohort (Stein et al. 2016a); no associations were found for measles or mumps antibody titers. Another study in adolescents did not find associations between recent serum PFHxS levels and tetanus or diphtheria antibody levels (Kielsen et al. 2016). A study in adults did not find associations between PFHxS levels and response to influenza vaccine; some alterations in serum cytokine levels were observed, but chemokine and IgA levels were not altered (Stein et al. 2016b).

In general, the available studies do not suggest an association between serum PFHxS and decreased infectious disease resistance. No alterations in the frequency of fever, cough, nasal discharge, otitis media, diarrhea, or vomiting were observed in children (Dalsager et al. 2016; Granum et al. 2013); one study found an association between maternal PFHxS levels and the number of episodes of gastroenteritis in children (Granum et al. 2013).

2. HEALTH EFFECTS

Figure 2-23. Antibody Responses Relative to Serum PFHxS Levels in Epidemiology Studies
 (Presented as percent difference in antibody concentration per 2-fold increase in serum PFHxS)

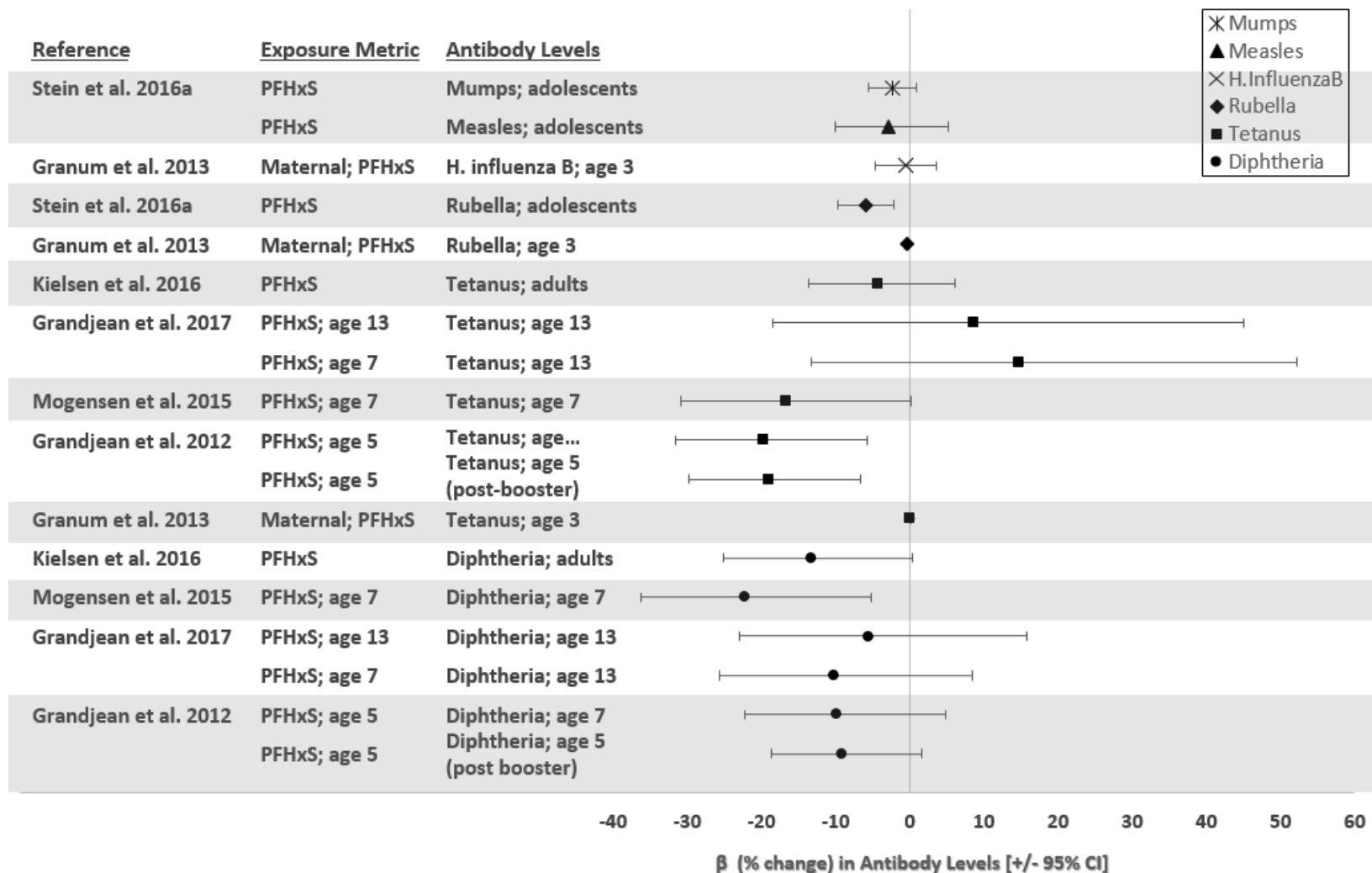

2. HEALTH EFFECTS

Epidemiology Studies—Hypersensitivity Outcomes. Data evaluating associations between serum PFHxS and the risk of asthma diagnosis are presented in Figure 2-24. No associations were observed between asthma diagnosis, wheezing, and/or eczema in children and maternal serum PFHxS levels (Granum et al. 2013; Smit et al. 2015) or with recent PFHxS levels in adolescents (Humblet et al. 2014; Okada et al. 2014). In contrast, case-control studies in asthmatic children did find associations between recent PFHxS serum levels and asthma diagnosis (Dong et al. 2013; Zhu et al. 2016), but no association with asthma severity (Dong et al. 2013). Dong et al. (2013) also reported associations between serum PFHxS levels and eosinophil counts and eosinophil cationic protein levels in asthmatic children, but not in non-asthmatics. No associations were found with IgE levels in either case-control study (Dong et al. 2013; Zhu et al. 2016) or in a study measuring cord blood IgE (Ashley-Martin et al. 2015).

An increased risk of food allergies associated with serum PFHxS levels, but not increased sensitivity to foods, was found in adolescents (Buser and Scinicariello 2016). Another study found no associations between serum PFHxS levels and allergic sensitization to plants, dust mites, pets, cockroaches/shrimp, rodents, mold, or food in adolescents (Stein et al. 2016a).

Laboratory Animal Studies. In the only available study evaluating immunotoxicity for PFHxS, Butenhoff et al. (2009a; Hoberman and York 2003) did not find histological alterations in the spleen, thymus, or lymph nodes of rats administered 10 mg/kg/day PFHxS via gavage for 42–56 days.

PFNA

Epidemiology Studies—Immunosuppression Outcomes. Most studies examining a possible association between serum PFNA levels and immunosuppression have not found associations. No associations were found between maternal or child PFNA levels and tetanus antibody levels at ages 3, 5, 7, or 13 (Grandjean et al. 2012, 2017; Granum et al. 2013) or in adults (Kielsen et al. 2016). Some studies have found associations between serum PFNA and diphtheria antibody levels, but the results were not consistent. Grandjean and associates found a significant inverse association between diphtheria antibodies levels at age 5 (Grandjean et al. 2012) and serum PFNA levels at age 5, but not for antibody levels at age 13 and PFNA levels at age 7 or 13 (Grandjean et al. 2017). Kielsen et al. (2016) also reported an inverse association (unadjusted for potential confounders) between serum PFNA and diphtheria antibody levels in a small study of adults. An inverse association between maternal serum PFNA and rubella antibody levels was observed in children (Granum et al. 2013), but there was no

2. HEALTH EFFECTS

Figure 2-24. Risk of Asthma Diagnosis Relative to PFHxS Levels (Presented as Adjusted Odds Ratios)

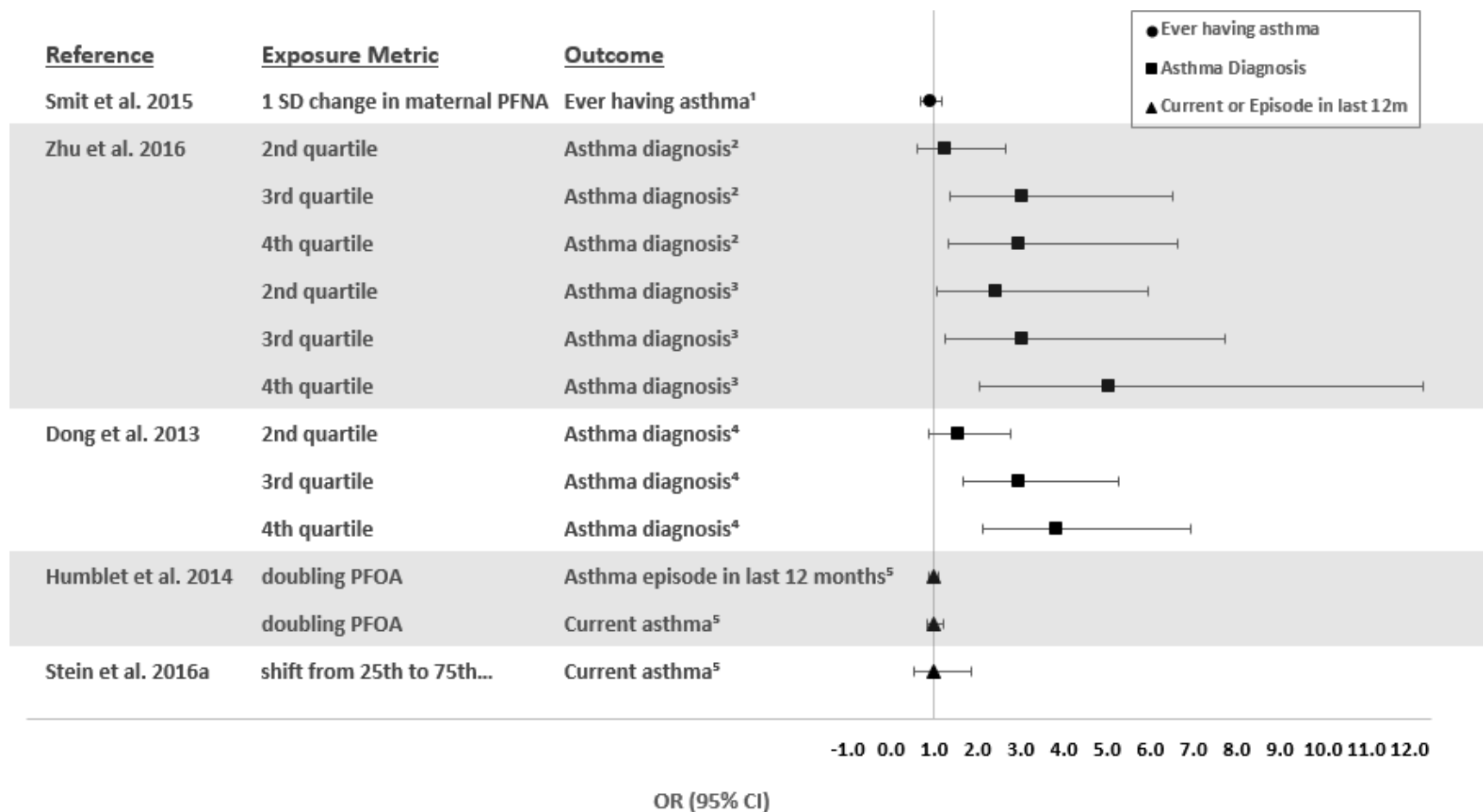

¹age 5–9 years
²males, age 9–16 years
³females age 9–16 years
⁴age 10–15 years
⁵age 12–19 years

2. HEALTH EFFECTS

association for influenza type B antibody levels. Similarly, no associations were found between recent PFNA serum levels and measles, mumps, or rubella antibody titers in adolescents (Stein et al. 2016a). Data evaluating associations between serum PFNA and altered antibody response are presented in Figure 2-25.

Overall, the epidemiology data do not suggest an association between decreased infectious disease resistance and serum PFNA levels. No alterations in the risk of increased number of days with fever, cough, nasal discharge, diarrhea, or vomiting were observed in children (Dalsager et al. 2016), although the study did find a significant increase in the number of days above the median for nasal discharge. Another study found that the number of episodes of the common cold in children was associated with maternal serum PFNA; no associations were found for otitis media or gastroenteritis (Granum et al. 2013).

Epidemiology Studies—Hypersensitivity Outcomes. Case-control studies of asthmatic children have reported associations between serum PFNA and asthma diagnosis (Dong et al. 2013; Zhu et al. 2016), but no association with asthma severity (Dong et al. 2013). However, cross-sectional or retrospective studies (Humblet et al. 2014; Smit et al. 2015; Stein et al. 2016a) have not found associations. Data evaluating associations between serum PFNA and the risk of asthma diagnosis are presented in Figure 2-26. No associations were found in adolescents between food allergies (Buser and Scinicariello 2016), allergies (Stein et al. 2016a), or allergic sensitizations to plants, dust mites, pets, cockroach/shrimp, rodents, mold, or food (Stein et al. 2016a). However, inverse associations between serum PFNA and food sensitizations were observed in adolescents (Buser and Scinicariello 2016) and between maternal serum PFNA and allergic diseases in infants (Okada et al. 2014). No increases in the risk of other hypersensitivity effects (wheezing, eczema, or atopic dermatitis) were observed (Humblet et al. 2014; Okada et al. 2014; Smit et al. 2015; Stein et al. 2016a; Wang et al. 2011).

Laboratory Animal Studies. Administration of PFNA for 14 days resulted in decreases in thymus and/or spleen weights at ≥ 3 mg/kg/day in rats and mice (Fang et al. 2008, 2009, 2010); at 1 mg/kg/day, an increase in thymus weight was observed in rats (Fang et al. 2009). Fang et al. (2009) reported increases in the ratio of thymic cortex to medulla in rats presumably administered ≥ 3 mg/kg/day PFNA. In the spleen, there were decreases in the percentage of F4/80+ and CD49b+ cells at ≥ 1 mg/kg/day and in CD11c+ cells at ≥ 3 mg/kg/day (Fang et al. 2008). Increases in pro-inflammatory cytokines were observed in the serum at ≥ 3 mg/kg/day (Fang et al. 2009) and spleen at 5 mg/kg/day (Fang et al. 2010).

2. HEALTH EFFECTS

Figure 2-25. Antibody Responses Relative to Serum PFNA Levels in Epidemiology Studies
 (Presented as percent difference in antibody concentration per 2-fold increase in serum PFNA)

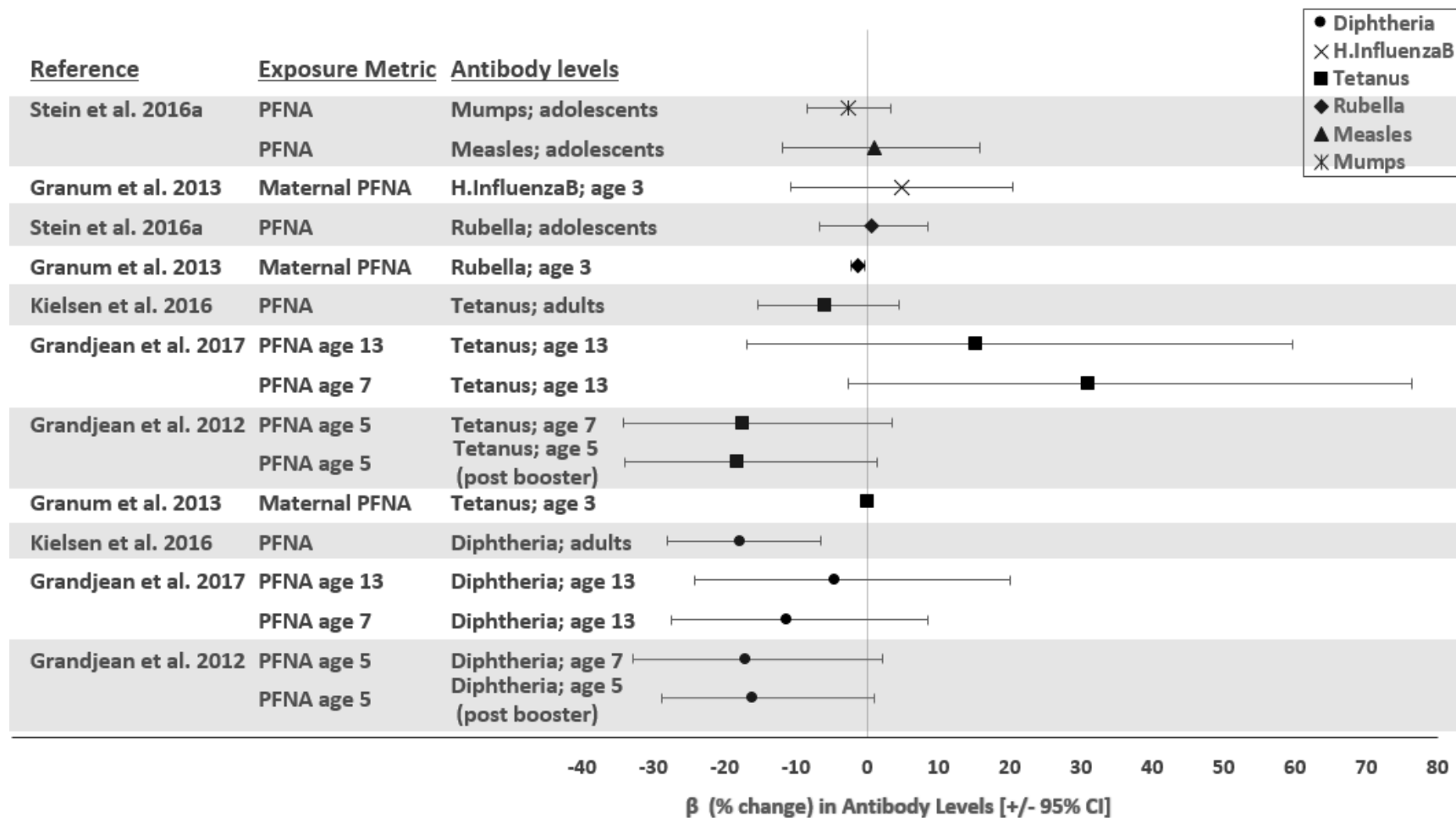

2. HEALTH EFFECTS

Figure 2-26. Risk of Asthma Diagnosis Relative to PFNA Levels (Presented as Adjusted Odds Ratios)

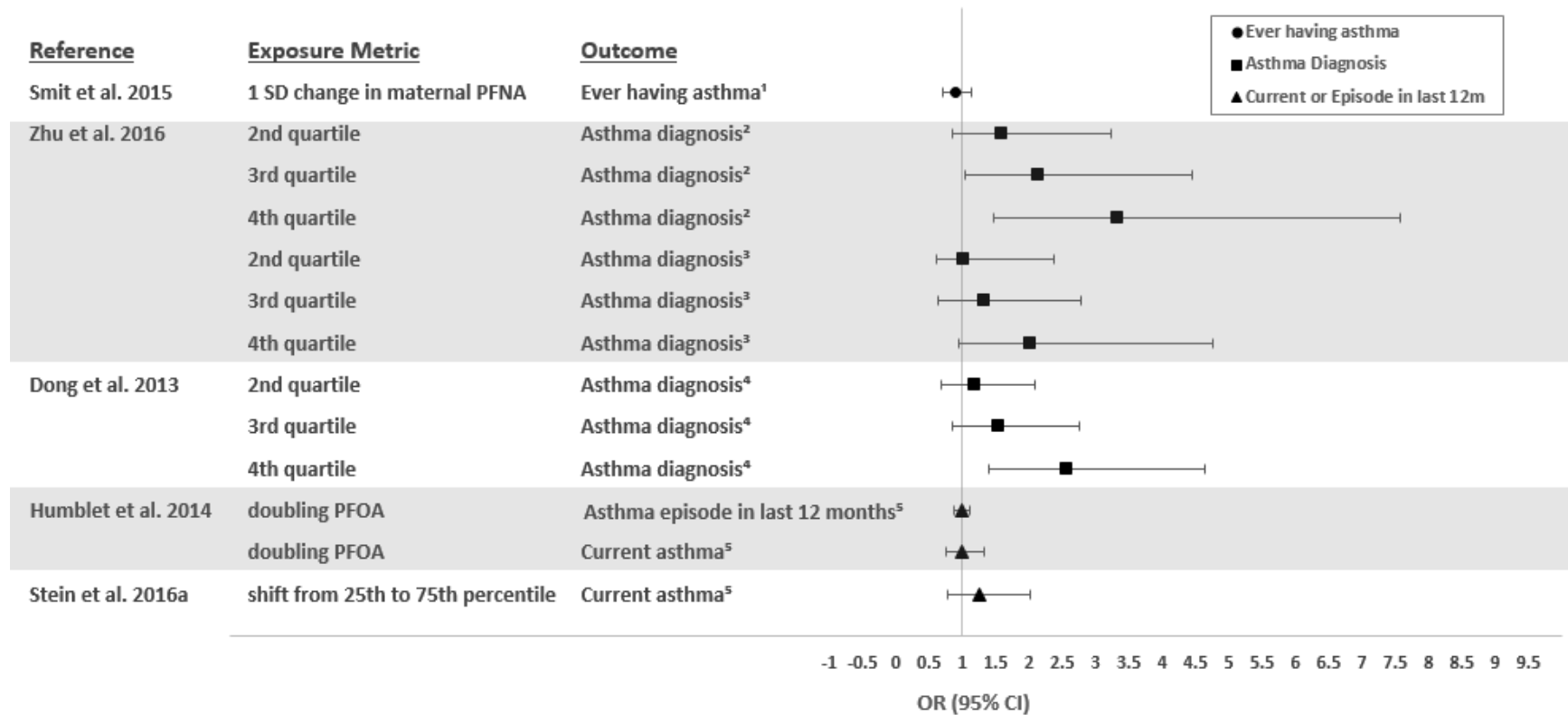

¹age 5–9 years
²males, age 9–16 years
³females age 9–16 years
⁴age 10–15 years
⁵age 12–19 years

2. HEALTH EFFECTS

No alterations were observed in the response of splenic T lymphocytes to ConA at 5 mg/kg/day (Fang et al. 2008).

Two weeks after a single intraperitoneal administration of 46 mg/kg PFNA to male and female B57BL/6J mice, a number of immunological alterations included significant decreases relative spleen weight and splenic leukocyte counts, alterations in splenic T-lymphocyte phenotypes (increased ratios of CD4+ and CD8+ cells), a decrease in viable thymic cells, a marked decrease in CD4+CD8+ thymic lymphocytes and an increase in CD4+ and CD8+ thymic lymphocytes, and increased levels of tumor necrosis factor- α in response to exposure to the LPS (Rockwell et al. 2013). Similar effects were observed 4 weeks post-exposure (Rockwell et al. 2017). Comparison of the results 2 weeks post-exposure to 4 weeks post-exposure showed a partial recovery in spleen weight and specific thymic lymphocyte subpopulations, but no recovery of the ratio of specific splenic lymphocytes, thymocyte viability, or response to LPS (Rockwell et al. 2017). Some sex-related differences were noted, with females appearing to be more sensitive than males (Rockwell et al. 2017).

PFDeA

Epidemiology Studies—Immunosuppression Outcomes. Studies examining possible associations between serum PFDeA levels and response to vaccines have reported mixed results; see Figure 2-27 for a graphical presentation of the antibody response relative to PFDeA levels. Inverse associations were observed between serum PFDeA levels at age 5 and tetanus antibody levels at ages 5 and 7 (Grandjean et al. 2012) and serum PFDeA levels at age 7 and antibody levels at age 13 (Grandjean et al. 2017). Similarly, diphtheria antibody levels at age 13 were inversely associated with serum PFDeA levels at age 7 (Grandjean et al. 2017), but no associations were observed at other time periods (Grandjean et al. 2012). In adults, diphtheria antibody levels were inversely associated with serum PFDeA levels, but there was no association for tetanus antibody levels (Kielsen et al. 2016); this study did not adjust for potential confounders. In the only study examining the possible association between serum PFDeA levels and infectious disease resistance, no association was found between maternal serum PFDeA levels and symptoms of infection in children aged 1–4 years (Dalsager et al. 2016).

Epidemiology Studies—Hypersensitivity Outcomes. In case-control studies, associations between asthma diagnosis and asthma severity were observed in children (Dong et al. 2013; Zhu et al. 2016); associations with serum IgE levels, absolute eosinophil counts, and eosinophil cationic protein levels

2. HEALTH EFFECTS

Figure 2-27. Antibody Responses Relative to Serum PFDeA Levels in Epidemiology Studies
 (Presented as percent difference in antibody concentration per 2-fold increase in serum PFDeA)

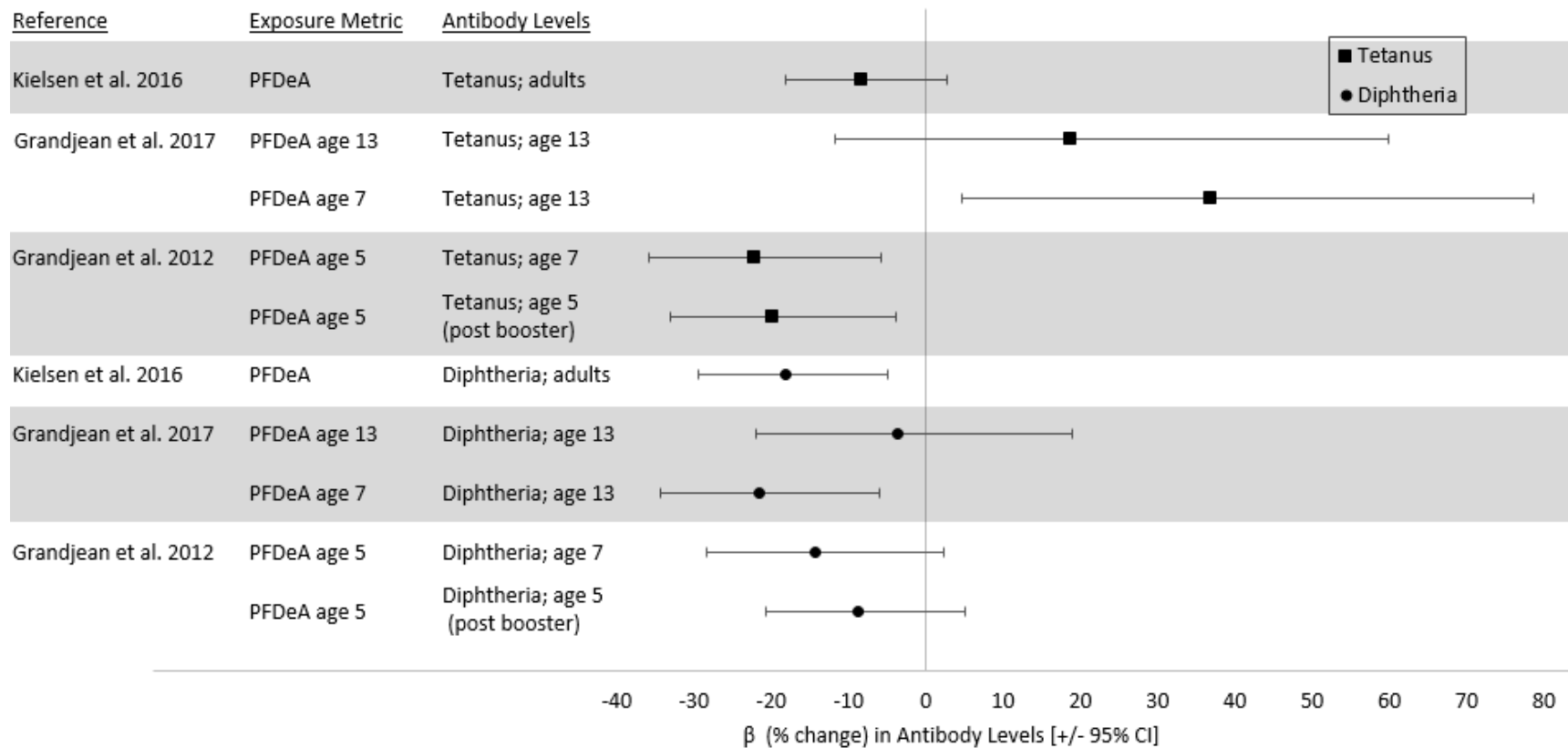

2. HEALTH EFFECTS

were also observed. A cross-sectional study of children did not find associations between maternal PFDeA levels and asthma, eczema, or wheezing in children (Smit et al. 2015). Another cross-sectional study found no association between allergic diseases or eczema in infant and maternal PFDeA levels (Okada et al. 2014). Data evaluating associations between serum PFDeA and the risk of asthma diagnosis are presented in Figure 2-28.

Laboratory Animal Studies. A single gavage dose of 80 mg/kg PFDeA did not significantly alter relative thymus weight in female C57BL/6N mice, but it caused a 28% decrease in relative spleen weight 30 days after dosing (Harris et al. 1989). Lethal doses (160 and 320 mg/kg) induced atrophy and lymphoid depletion in both the thymus and spleen.

PFUA

Epidemiology Studies. Three epidemiology studies have evaluated the potential immunotoxicity of PFUA in humans. Kielsen et al. (2016) reported inverse associations between serum PFUA (unadjusted for potential confounders) and diphtheria and tetanus antibody levels in adults. No significant associations between maternal PFUA levels and the risk of asthma diagnosis, eczema, or wheezing were observed in children (Smit et al. 2015). The third study (Okada et al. 2012) found inverse associations between maternal serum PFUA and risk of allergies or eczema in female infants, but not in males.

PFHpA

Epidemiology Studies. In general, the two available human immunotoxicity studies did not find associations between serum PFHpA levels and diphtheria or tetanus antibody levels in adults (Kielsen et al. 2016) or risk of asthma diagnosis, eczema, or wheezing in children (Smit et al. 2015). The Smit et al. (2015) study did find an inverse association between maternal PFHpA levels and current wheezing in one subcohort; however, this was not observed in the other subcohort with higher mean maternal PFHpA levels.

PFBuS

Epidemiology Studies. The epidemiology database for PFBuS consists of two case-control studies in asthmatic children (Dong et al. 2013; Zhu et al. 2016). Both studies reported increases in asthma diagnosis, but no association with serum IgE levels.

2. HEALTH EFFECTS

Figure 2-28. Risk of Asthma Diagnosis Relative to PFDeA Levels (Presented as Adjusted Odds Ratios)

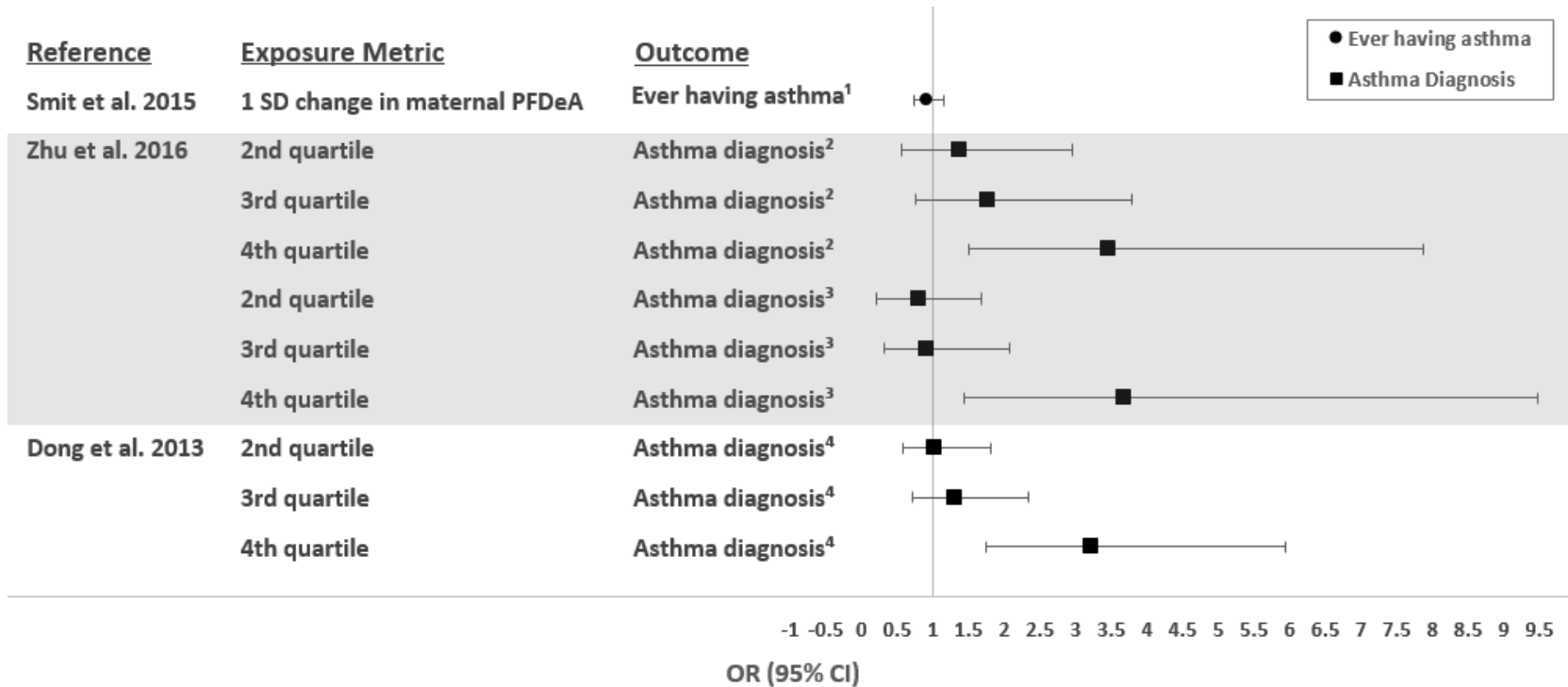

¹age 5–9 years
²males, age 9–16 years
³females age 9–16 years
⁴age 10–15 years

2. HEALTH EFFECTS

Laboratory Animal Studies. No significant histological alterations were observed in spleen, thymus, or lymph nodes of rats administered via gavage 900 mg/kg/day for 28 days (3M 2001).

PFBA

Laboratory Animal Studies. No significant gross or microscopic alterations were reported in the spleen, thymus, or mesenteric lymph nodes from rats dosed with PFBA by gavage in doses of up to 184 mg/kg/day for 5 days, 150 mg/kg/day for 28 days, or 30 mg/kg/day for 90 days (3M 2007a; Butenhoff et al. 2012a; van Otterdijk 2007a, 2007b).

PFD_oA

Epidemiology Studies. Four epidemiology studies examining potential immunotoxic endpoints were identified. Kielsen et al. (2016) found inverse associations between recent serum PFD_oA levels (not adjusted for potential confounders) and diphtheria and tetanus antibody levels in adults. Associations between serum PFD_oA levels and the risk of asthma diagnosis, severity of asthma, serum IgE levels, absolute eosinophil counts, and eosinophil cationic protein levels were observed in a case-control study of asthmatic children (Dong et al. 2013). A cross-sectional study of children did not find associations between maternal serum PFD_oA levels and risk of asthma diagnosis, eczema, or wheezing (Smit et al. 2015). Another study did not find associations between maternal serum PFD_oA levels and the risk of allergic disease or eczema in infants (Okada et al. 2014).

PFHxA

Epidemiology Studies. In the only epidemiology study examining potential immunotoxic endpoints, Dong et al. (2013) found no associations between serum PFHxA levels in asthmatic and nonasthmatic children and asthma diagnosis, asthma severity, or IgE levels.

2.15 NEUROLOGICAL

Overview. There are limited data on the neurotoxicity of perfluoroalkyls in humans or laboratory animals; epidemiology data come from two studies examining memory and animal studies primarily evaluated for morphological alterations; the results of these human studies are summarized in Table 2-17 with more detailed descriptions in the *Supporting Document for Epidemiological Studies for*

2. HEALTH EFFECTS

Table 2-17. Summary of Neurological Outcomes in Humans^a

Reference and study population ^b	Serum perfluoroalkyl level	Outcome evaluated	Result ^c
PFOA			
Gallo et al. 2013 Community (C8) (n=21,024 older adults; >50 years of age)	14.1–27.0 ng/mL (2 nd PFOA quintile)	Memory loss (self- reported)	OR 0.88 (0.79–0.97)*, 2nd quintile
Power et al. 2013 General population (NHANES) (n=1,766 older adults aged 60–<85 years)	4.08 ng/mL (median PFOA)	Difficulty remembering or periods of confusion (self- reported)	OR 0.92 (0.78–1.09)
PFOS			
Gallo et al. 2013 Community (C8) (n=21,024 older adults; >50 years of age)	20.5–27.1 ng/mL (3 rd PFOS quintile)	Memory loss (self- reported)	OR 0.86 (0.78–0.96)*, 3rd quintile
Power et al. 2013 General population (NHANES) (n=1,766 older adults aged 60–<85 years)	22.63 ng/mL (median PFOS)	Difficulty remembering or periods of confusion (self- reported)	OR 0.90 (0.78–1.03)
PFHxS			
Gallo et al. 2013 Community (C8) (n=21,024 older adults; >50 years of age)	5.7–232.6 ng/mL (5 th PFHxS quintile)	Memory loss (self- reported)	OR 0.89 (0.79–0.99)*, 5th quintile
Power et al. 2013 General population (NHANES) (n=1,766 older adults aged 60–<85 years)	2.05 ng/mL (median PFHxS)	Difficulty remembering or periods of confusion (self- reported)	OR 0.93 (0.82–1.06)
PFNA			
Gallo et al. 2013 Community (C8) (n=21,024 older adults; >50 years of age)	1.0–1.2 ng/mL (2 nd PFNA quintile)	Memory loss (self- reported)	OR 0.86 (0.78–0.96)*, 2nd quintile

2. HEALTH EFFECTS

Table 2-17. Summary of Neurological Outcomes in Humans^a

Reference and study population ^b	Serum perfluoroalkyl level	Outcome evaluated	Result ^c
Power et al. 2013 General population (NHANES) (n=1,766 older adults aged 60–<85 years)	1.01 ng/mL (median PFNA)	Difficulty remembering or periods of confusion (self-reported)	OR 0.91 (0.79–1.04)

^aSee the *Supporting Document for Epidemiological Studies for Perfluoroalkyls*, Table 11 for more detailed descriptions of studies.

^bParticipants in occupational exposure may have also lived near the site and received residential exposure; community exposure studies involved subjects living near PFOA facilities with known exposure to high levels of PFOA.

^cAsterisk indicates association with perfluoroalkyl compound; unless otherwise specified, values in parenthesis are 95% confidence intervals.

OR = odds ratio; NHANES = National Health and Nutrition Examination Survey; PFHxS = perfluorohexane sulfonic acid; PFNA = perfluorononanoic acid; PFOA = perfluorooctanoic acid; PFOS = perfluorooctane sulfonic acid

1

2. HEALTH EFFECTS

Perfluoroalkyls, Table 11. The potential to induce neurodevelopmental effects (including the risk of attention deficit hyperactivity disorder [ADHD]) has been more widely studied; these data are discussed in Section 2.17, Developmental. There are limited epidemiology data on the neurotoxicity of perfluoroalkyls. The two available studies found decreases in the risk of memory loss associated with serum PFOA, PFOS, PFHxS, and PFNA.

The results of the laboratory animal studies are presented in Tables 2-1, 2-3, 2-4, 2-5, and 2-6 and in Figures 2-4, 2-6, 2-7, and 2-8. No morphological alterations in the brain and nerves were observed in studies of PFOA, PFOS, PFBuS, or PFBA. No alterations in neurological function tests were observed in studies of PFHxS, PFHxA, PFBA, or PFDoA. Impaired learning and memory was observed in a study of PFOS and decreases in grip strength were observed in a study of PFUA.

PFOA

Epidemiology Studies. Gallo et al. (2013) found a decreased risk of self-reported memory loss in older adult (>50 years of age) C8 participants with serum PFOA levels in the 2nd, 3rd, 4th, or 5th quintiles. When the participants were categorized by diabetic status, the risk of memory loss was higher among the diabetics than nondiabetics (p=0.014). In sensitivity analyses, the association between serum PFOA levels and memory impairment was compared within and across water districts. Within a water district, the association between serum PFOA and memory impairment was significant, but there was no association between the geometric mean concentration of PFOA in a district and memory impairment. In a second study, no association between serum PFOA and self-reported difficulty remembering or periods of confusion was found in NHANES participants aged 60–<85 years (Power et al. 2013).

Laboratory Animal Studies. Exposure of rats to 18,600 mg/m³ APFO dusts for 1 hour induced excessive salivation. Intermittent, head-only exposure of male rats exposed to up to 84 mg/m³ APFO dusts for 2 weeks did not reveal gross or microscopic alterations in the brain (Kennedy et al. 1986).

A small number of studies have examined the potential toxicity of perfluoroalkyls to the nervous system in animals, but comprehensive testing has not been conducted. No alterations in performance on a novel recognition test were observed in rats administered a single 50 mg/kg dose of PFOA (Kawabata et al. 2017). No overt signs of neurotoxicity or altered response to stimuli were observed in rats and mice administered up to 1,000 mg/kg PFOA via gavage and observed for 14 days (Sato et al. 2009). Exposure of rats to up to approximately 110 mg/kg/day PFOA via the diet for 90 days did not induce gross or

2. HEALTH EFFECTS

microscopic alterations in the brain, spinal cord, or peripheral nerves (Griffith and Long 1980). Similar results were reported in rats fed a diet that provided approximately 15 mg/kg/day PFOA for 2 years (3M 1983). Rhesus monkeys exposed to doses of PFOA that caused lethality (≥ 30 mg/kg/day by gavage) showed signs of hypoactivity and prostration, but examination of the brain did not reveal treatment-related alterations (Griffith and Long 1980). Treatment of Cynomolgus monkeys with doses of up to 20 mg/kg/day PFOA administered via a capsule did not induce morphological alterations in the brain or sciatic nerve (Butenhoff et al. 2002).

Similarly, no gross or microscopic alterations were reported in the brain from rats dermally exposed to APFO in the Kennedy (1985) study.

PFOS

Epidemiology Studies. Two studies have examined the influence of serum PFOS levels on self-reported memory in older adults. Gallo et al. (2013) found an inverse association between serum PFOS levels and the risk of memory loss in C8 Health Study participants. No association for difficulty remembering or periods of confusion was found in the second study of NHANES participants (Power et al. 2013).

Laboratory Animal Studies. No histological alterations were observed in the brain, spinal cord, and/or sciatic nerve of rats administered a single gavage dose of up to 500 mg/kg PFOS (Sato et al. 2009), rats treated with up to 1.6–1.8 mg/kg/day PFOS for 4 or 14 weeks (Seacat et al. 2003), rats exposed to 8.5 mg/kg/day PFOS in the diet for 13 weeks (Kawamoto et al. 2011), rats exposed to 1.04 mg/kg/day PFOS in the diet for 2 years (Butenhoff et al. 2012b; Thomford 2002b), or Cynomolgus monkeys dosed with up to 0.75 mg/kg/day PFOS for 26 weeks (Seacat et al. 2002). However, ultrasonic stimulation resulted in bursts of locomotion immediately followed by tonic convulsions in mice administered 125 mg/kg PFOS and rats administered 250 mg/kg PFOS (Sato et al. 2009); the effect was observed 1–7 days postexposure and frequently resulted in death. Similarly, tonic convulsions following ultrasonic stimulation were observed in rats exposed to 8.5 mg/kg/day PFOS in the diet for 6 weeks (Kawamoto et al. 2011); this effect was not observed at ≤ 2.0 mg/kg/day. Impaired spatial learning and memory, assessed using the Morris water maze test, was observed in mice administered 2.15 or 10.75 mg/kg/day PFOS, but not 0.43 mg/kg/day, for 3 months (Long et al. 2013). Similarly, impaired performance on retention tasks, as assessed by the water maze test, was observed in mice administered 3 or 6 mg/kg/day PFOS for 4 weeks (Fuentes et al. 2007c). Histopathological examination of the hypothalamus in male Sprague-Dawley rats administered PFOS via gavage for 28 days revealed degeneration of gonadotropic

2. HEALTH EFFECTS

cells of the pituitary gland at ≥ 1.0 mg/kg/day and dense chromatin, condensed ribosomes, and loss of morphology in the hypothalamus at ≥ 3.0 mg/kg/day (López-Doval et al. 2014).

PFHxS

Epidemiology Studies. A decrease in the risk of self-reported memory loss was observed in older adult participants of the C8 Health Study who had serum PFHxS levels in the 5th quintile (Gallo et al. 2013). No association between serum PFHxS levels and self-reported difficulty remembering or periods of confusion was reported in a study of NHANES participants (Power et al. 2013).

Laboratory Animal Studies. In a reproductive study in rats dosed with PFHxS, a functional observational battery (FOB) and motor activity tests were conducted in males on exposure days 36 and 39 and in females on postpartum day 17 (Butenhoff et al. 2009a; Hoberman and York 2003). The battery assessed autonomic functions, reactivity and sensitivity to stimuli, excitability, gait and sensorimotor coordination, limb grip strength, and abnormal clinical signs. No significant alterations were reported in males or females dosed with up to 10 mg/kg/day PFHxS.

PFNA

Epidemiology Studies. Self-reported memory loss was shown to be inversely associated with serum PFNA levels in a study of older C8 Health Study participants (Gallo et al. 2013). Another study of NHANES participants did not find an association with self-reported difficulty remembering or periods of confusion (Power et al. 2013).

PFUA

Laboratory Animal Studies. In the only study located for PFUA, a decrease in grip strength was observed in male and female rats administered 1.0 mg/kg/day PFUA for 41–46 days and allowed to recover for 14 days (Takahashi et al. 2014). No other alterations in performance on FOB tests were found.

2. HEALTH EFFECTS

PFBuS

Laboratory Animal Studies. A significant decrease in tail flick latency to a thermal stimulus was observed in all groups of male rats administered via gavage PFBuS for 28 days. However, other tests of sensory reactivity to stimuli, grip strength, and motor activity were not affected (3M 2001), and the significance of this isolated finding is difficult to ascertain. Gross and microscopic examination of the brain, spinal cord, and sciatic nerve did not show any significant alterations. In a 90-day study, no significant alterations in motor activity or performance on functional observation tests were observed in rats at PFBuS doses as high as 600 mg/kg/day (Lieder et al. 2009a).

PFBA

Laboratory Animal Studies. Administration of up to 184 mg/kg/day PFBA by gavage for 5 consecutive days to rats had no significant effect on the gross or microscopic morphology of the brain or spinal cord (3M 2007a). In a 28-day gavage study, male rats dosed with 150 mg/kg/day, but not 30 mg/kg/day, showed a delay in bilateral pupillary reflex at the end of the treatment period (Butenhoff et al. 2012a; van Otterdijk 2007a). Results from other tests, including hearing ability, static righting reflex, grip strength, and motor activity, were comparable between groups, and histological examinations of the brain (including the optic nerve), spinal cord, and sciatic nerve were unremarkable. In a 90-day study, pupillary reflex tests conducted in weeks 8 and 12 showed delayed dilation under dark conditions in rats dosed with 30 mg/kg/day (2/40 in controls versus 7/39 in high-dose rats; $p=0.071$ according to the Fisher Exact Test) (Butenhoff et al. 2012a; van Otterdijk 2007b). Since no abnormalities were recorded during a 3-week recovery period, and there were no histopathological alterations in the eyes, the effect was not considered biologically significant by the investigators. Tests for hearing ability, static righting reflex, grip strength, and motor activity showed no associations with treatment with PFBA. In addition, there were no significant gross or microscopic alterations in the brain, spinal cord, or sciatic nerve.

PFDoA

Laboratory Animal Studies. Single-dose administration of 50 mg/kg resulted in impaired performance on a novel object recognition test, but did not result in alterations in other tests of memory, anxiety, or open field activity (Kawabata et al. 2017).

2. HEALTH EFFECTS

PFHxA

Laboratory Animal Studies. Treatment with 100 or 200 mg/kg/day PFHxA in male and female Sprague-Dawley rats via gavage for 104 weeks had no effect on locomotion or performance in the FOB test (Klaunig et al. 2015).

2.16 REPRODUCTIVE

Overview. A number of epidemiology studies have evaluated the reproductive toxicity of perfluoroalkyls; summaries of these studies are presented in the *Supporting Document for Epidemiological Studies for Perfluoroalkyls*, Table 12. These studies have evaluated the following categories of reproductive outcomes: alterations in reproductive hormone levels; effects on sperm; effects on menopause onset, menstrual cycle length, endometriosis, and breastfeeding duration; and effects on fertility. Overviews of the studies examining these specific endpoints are presented in Tables 2-18, 2-19, 2-20, and 2-21, respectively. In addition to these reproductive outcomes, several epidemiology studies have evaluated the influence of perfluoroalkyls on sexual maturation; these data are discussed in Section 2.17, Developmental. Although some studies examining reproductive hormone levels have found associations with PFOA, PFOS, or PFUA levels, the findings are not consistent across studies or there are too few studies to interpret the results. Alterations in reproductive hormone levels have not been found in studies of PFHxS, PFNA, PFDeA, or PFOSA. Some associations between serum perfluoroalkyls (PFOA, PFOS, PFHxS, PFNA, PFDeA) levels and sperm parameters have been found; often, only one sperm parameter was altered and it is difficult to assess the adversity of this alteration. There is some suggestive evidence of an association between serum PFOA, PFOS, PFHxS, or PFNA levels and an increased risk of early menopause; however, this may be due to reverse causation since an earlier onset of menopause would result in a decrease in the removal of perfluoroalkyls in menstrual blood. Epidemiology studies of PFOA and PFOS provide evidence of impaired fertility (increased risks of longer time to pregnancy and infertility); there is also some evidence for PFHxS and PFNA, but the results are not consistent across studies. The small number of studies evaluating fertility for PFDeA, PFUA, PFOSA, Me-PFOSA-AcOH, and Et-PFOSA-AcOH did not find associations.

Studies in laboratory animals have evaluated the potential histological alterations in reproductive tissues, alterations in reproductive hormones, and impaired reproductive functions. Summaries of these studies

2. HEALTH EFFECTS

Table 2-18. Summary of Alterations in Reproductive Hormone Levels in Humans^a

Reference and study population ^b	Serum perfluoroalkyl level	Outcome evaluated	Result ^c
PFOA			
Olsen et al. 1998b Occupational (n=111 males in 1993 and 80 males in 1995)	0–80,000 ng/mL (PFOA range)	Prolactin	Association (p=0.01 for trend)*, 1993 NS (p=0.58 for trend), 1995
		Estradiol	NS (p=0.66 and 0.56 for trend), 1993 and 1995
		17 α -Hydroxy-progesterone	NS (p=0.21 and 0.18 for trend), 1993 and 1995
		Bound testosterone	NS (p=0.07 and 0.85 for trend), 1993 and 1995
		Free testosterone.	NS (p=0.15 or 0.82 for trend), 1993 and 1995
Sakr et al. 2007b Occupational (n=1,025)	428 ng/mL (mean PFOA)	Estradiol	Association (p=0.017)*, males
		Testosterone	Association (p=0.034)*, males
Knox et al. 2011 Community (C8) (n=25,957 women)	11.3–19.8 ng/mL (2 nd PFOA quintile)	Estradiol concentration	NS (p>0.05), menopausal and perimenopausal subgroups
Barrett et al. 2015 General population (n=178 women)	3.61 and 2.31 ng/mL (mean PFOA in nulliparous and parous women)	Follicular estradiol	NS (95% CI included unity), whole cohort and parous and nulliparous subcohorts
		Luteal progesterone	NS (95% CI included unity), whole cohort and parous and nulliparous subcohorts
Joensen et al. 2013 General population (n=247 young men; mean age 19.6 years)	3.46 ng/mL (mean PFOA)	Total testosterone	NS (p>0.05)
		Free testosterone	NS (p>0.05)
		Free androgen index	NS (p>0.05)
		LH	NS (p>0.05)
		Estradiol	NS (p>0.05)
		SHBG	NS (p>0.05)
		FSH	NS (p>0.05)

2. HEALTH EFFECTS

Table 2-18. Summary of Alterations in Reproductive Hormone Levels in Humans^a

Reference and study population ^b	Serum perfluoroalkyl level	Outcome evaluated	Result ^c
Raymer et al. 2012 General population (n=256 men)	10.4 ng/mL (mean PFOA)	Estradiol	NS (p=0.751)
		Prolactin	NS (p=0.349)
		FSH	NS (p=0.581)
		LH	Correlation (p=0.011)*
		Free testosterone	Correlation (p=0.015)*
		Total testosterone	NS (p=0.440)
Specht et al. 2012 General population (n=604 men)	1.3–4.8 (range of PFOA means of different sites)	SHBG	NS (p=0.39 for trend)
Tsai et al. 2015 General population (n=540 adolescents and young adults aged 12–30 years)	2.74 ng/mL (geometric mean PFOA)	SHBG	Association (p<0.05)*, females 12–17 years old
		FSH	NS (p>0.05)
		Testosterone	NS (p>0.05)
Vested et al. 2013 General population (n=169 males aged 19–21 years)	3.8 ng/mL (median maternal PFOA)	Testosterone	NS (p>0.05)
		Estradiol	NS (p>0.05)
		Inhibin B	NS (p>0.05)
		SHBG	NS (p>0.05)
		Free antigen index	NS (p>0.05)
		LH	Association (p=0.03)*
		FSH	Association (p=0.01)*
PFOS			
Olsen et al. 1998a Occupational (n=327)	1,480–2,440 ng/mL (range of PFOS means at different time periods)	DHEAS	NS (p=0.60)
		FSH	NS (p=0.91)
		17-HP	NS (p=0.99)
		LH	NS (p=0.69)
		Prolactin	NS (p=0.25)
		SHBG	NS (p=0.77)
		Free testosterone	NS (p=0.90)

2. HEALTH EFFECTS

Table 2-18. Summary of Alterations in Reproductive Hormone Levels in Humans^a

Reference and study population ^b	Serum perfluoroalkyl level	Outcome evaluated	Result ^c
		Bound testosterone	NS (p=0.35)
		Estradiol	NS (p=0.14), after removal of 1 outlier
Knox et al. 2011 Community (C8) (n=25,957 women)	11.9–17.0 and 17.1–22.4 ng/mL (2 nd and 3 rd PFOS quintiles)	Estradiol concentration Perimenopausal subgroup Menopausal subgroup	Inverse association (p=0.0001)* Inverse association (p=0.007)*
Barrett et al. 2015 General population (n=178 women)	16.44 and 14.18 ng/mL (mean PFOS in nulliparous and parous women)	Follicular estradiol Luteal progesterone	Inverse association (β -0.013, 95% CI -0.023 to -0.001)*, whole cohort Inverse association (β -0.025, 95% CI -0.043 to -0.007)*, nulliparous subcohort NS (95% CI included unity), whole cohort and parous and nulliparous subcohorts
Joensen et al. 2013 General population (n=247 young men; mean age 19.6 years)	8.46 ng/mL (mean PFOS)	Total testosterone Free testosterone Free androgen index LH Estradiol SHBG FSH	Inverse association (p<0.05)* Inverse association (p<0.05)* Inverse association (p<0.05)* NS (p>0.05) NS (p>0.05) NS (p>0.05) NS (p>0.05)
Raymer et al. 2012 General population (n=256 men)	37.4 ng/mL (mean PFOS)	Estradiol Prolactin FSH LH Free testosterone Total testosterone	NS (p>0.05) NS (p>0.05) NS (p>0.05) NS (p>0.05) NS (p>0.05) NS (p>0.05)

2. HEALTH EFFECTS

Table 2-18. Summary of Alterations in Reproductive Hormone Levels in Humans^a

Reference and study population ^b	Serum perfluoroalkyl level	Outcome evaluated	Result ^c
Tsai et al. 2015 General population (n=540 male and female adolescents and young adults aged 12–30 years)	7.78 ng/mL (geometric mean PFOS)	SHGB	NS (p>0.05)
		FSH	Inverse association (p<0.05)*, males 12–17 years old
		Testosterone	Inverse association (p<0.05)*, females 12–17 years old
Vested et al. 2013 General population (n=169 males aged 19–21 years)	21.2 ng/mL (median maternal PFOS)	Testosterone	NS (p>0.05)
		Estradiol	NS (p>0.05)
		Inhibin B	NS (p>0.05)
		SHBG	NS (p>0.05)
		Free antigen index	NS (p>0.05)
		LH	NS (p>0.05)
		FSH	NS (p>0.05)
PFHxS			
Barrett et al. 2015 General population (n=178 women)	1.22 and 1.65 ng/mL (mean PFHxS in nulliparous and parous women)	Follicular estradiol	NS (95% CI included unity), whole cohort and parous and nulliparous subcohorts
		Luteal progesterone	NS (95% CI included unity), whole cohort and parous and nulliparous subcohorts
Joensen et al. 2013 General population (n=247 young men; mean age 19.6 years)	0.81 ng/mL (mean PFHxS)	Total testosterone	NS (p>0.05)
		Free testosterone	NS (p>0.05)
		Free androgen index	NS (p>0.05)
		LH	NS (p>0.05)
		Estradiol	NS (p>0.05)
		SHBG	NS (p>0.05)
		FSH	NS (p>0.05)

2. HEALTH EFFECTS

Table 2-18. Summary of Alterations in Reproductive Hormone Levels in Humans^a

Reference and study population ^b	Serum perfluoroalkyl level	Outcome evaluated	Result ^c
PFNA			
Barrett et al. 2015 General population (n=178 women)	0.67 and 0.60 ng/mL (mean PFNA in nulliparous and parous women)	Follicular estradiol	NS (95% CI included unity), whole cohort and parous and nulliparous subcohorts
		Luteal progesterone	NS (95% CI included unity), whole cohort and parous and nulliparous subcohorts
Joensen et al. 2013 General population (n=247 young men; mean age 19.6 years)	1.23 ng/mL (mean PFNA)	Total testosterone	NS (p>0.05)
		Free testosterone	NS (p>0.05)
		Free androgen index	NS (p>0.05)
		LH	NS (p>0.05)
		Estradiol	Association (p<0.05)*
		SHBG	NS (p>0.05)
Tsai et al. 2015 General population (n=540 male and female adolescents and young adults aged 12–30 years)	1.10 ng/mL (geometric mean PFNA)	SHBG	NS (p>0.05)
		FSH	NS (p>0.05)
		Testosterone	NS (p>0.05)
PFDaA			
Barrett et al. 2015 General population (n=178 women)	0.25 and 0.24 ng/mL (mean PFDaA in nulliparous and parous women)	Follicular estradiol	NS (95% CI included unity), whole cohort and parous and nulliparous subcohorts
		Luteal progesterone	NS (95% CI included unity), whole cohort and parous and nulliparous subcohorts

2. HEALTH EFFECTS

Table 2-18. Summary of Alterations in Reproductive Hormone Levels in Humans^a

Reference and study population ^b	Serum perfluoroalkyl level	Outcome evaluated	Result ^c
Joensen et al. 2013 General population (n=247 young men; mean age 19.6 years)	0.38 ng/mL (mean PFDeA)	Total testosterone	NS (p>0.05)
		Free testosterone	NS (p>0.05)
		Free androgen index	NS (p>0.05)
		LH	NS (p>0.05)
		Estradiol	NS (p>0.05)
		SHBG	NS (p>0.05)
		FSH	NS (p>0.05)
PFUA			
Barrett et al. 2015 General population (n=178 women)	0.40 and 0.42 ng/mL (mean PFUA in nulliparous and parous women)	Follicular estradiol	NS (95% CI included unity), whole cohort and parous and nulliparous subcohorts
		Luteal progesterone	NS (95% CI included unity), whole cohort and parous and nulliparous subcohorts
Tsai et al. 2015 General population (n=540 males and females aged 12–30 years)	5.84 ng/mL (geometric mean PFUA)	SHBG	NS (p>0.05)
		FSH	Inverse association (p<0.05)*, females 12–17 years old
		Testosterone	NS (p>0.05)

2. HEALTH EFFECTS

Table 2-18. Summary of Alterations in Reproductive Hormone Levels in Humans^a

Reference and study population ^b	Serum perfluoroalkyl level	Outcome evaluated	Result ^c
PFOSA			
Barrett et al. 2015 General population (n=178 women)	0.25 and 0.23 ng/mL (mean PFOSA in nulliparous and parous women)	Follicular estradiol	NS (95% CI included unity), whole cohort and parous and nulliparous subcohorts
		Luteal progesterone	NS (95% CI included unity), whole cohort and parous and nulliparous subcohorts

^aSee the *Supporting Document for Epidemiological Studies for Perfluoroalkyls*, Table 12 for more detailed descriptions of studies.

^bParticipants in occupational exposure may have also lived near the site and received residential exposure; community exposure studies involved subjects living near PFOA facilities with known exposure to high levels of PFOA.

^cAsterisk indicates association with perfluoroalkyl compound; unless otherwise specified, values in parenthesis are 95% confidence intervals.

CI = confidence interval; DHEAS = dihydroepiandrosterone sulfate; FSH = follicle stimulating hormone; LH = luteinizing hormone; NS = not significant; PFHxS = perfluorohexane sulfonic acid; PFNA = perfluorononanoic acid; PFOA = perfluorooctanoic acid; PFOS = perfluorooctane sulfonic acid; PFOSA = perfluorooctane sulfonamide; PFUA = perfluoroundecanoic acid; SHBG = sex hormone binding globulin

2. HEALTH EFFECTS

Table 2-19. Summary of Male Reproductive Outcomes in Humans^a

Reference and study population ^b	Serum perfluoroalkyl level	Outcome evaluated	Result ^c
PFOA			
Buck Louis et al. 2015 General population (n=96 Michigan and 366 in Texas)	4.6 and 5.3 ng/mL (median PFOA in Michigan and Texas)	Sperm viability	NS (p>0.05)
		Sperm count	NS (p>0.05)
		Sperm motility	
		↑ curvilinear velocity	Association (p<0.05)*
		Other parameters	NS (p>0.05)
		Sperm morphology	
		↑ percentage of sperm head acrosome area	Association (p<0.05)*
↓ percentage sperm with coiled tails	Association (p<0.05)*		
Other parameters	NS (p<0.05)		
Joensen et al. 2013 General population (n=247 young men; mean age of 19.6 years)	3.46 ng/mL (mean PFOA)	Sperm volume	NS (p>0.05)
		Sperm concentration	NS (p>0.05)
		Sperm count	NS (p>0.05)
		Percentage progressive motile sperm	NS (p>0.05)
		Sperm morphology	NS (p>0.05)
Kvist et al. 2012 General population (n=588 men)	1.91–5.19 ng/mL (range of PFOA means)	Y-X chromosome ratio	NS (p>0.05)
Raymer et al. 2012 General population (n=256 men)	10.4 ng/mL (mean PFOA)	Semen volume	NS (p>0.05)
		Semen pH	NS (p>0.05)
		Sperm motility	NS (p>0.05)
		Sperm concentration	NS (p>0.05)
Toft et al. 2012 General population (n=588 males)	3.8 ng/mL (median PFOA)	↑ percent motile sperm	Association (p<0.05)*
		Sperm concentration	NS (p>0.05)
		Sperm volume	NS (p>0.05)
		Sperm count	NS (p>0.05)
		Sperm morphology	NS (p>0.05)

2. HEALTH EFFECTS

Table 2-19. Summary of Male Reproductive Outcomes in Humans^a

Reference and study population ^b	Serum perfluoroalkyl level	Outcome evaluated	Result ^c
Vested et al. 2013 General population (n=169 males aged 19–21 years)	3.8 ng/mL (median maternal PFOA)	Sperm concentration	Inverse association (p=0.01)*
		Total sperm count	Inverse association (p=0.001)*
		Semen volume	NS (p>0.05)
		Percentage progressive spermatozoa	NS (p>0.05)
		Percentage morphologically normal spermatozoa	NS (p>0.05)
		Mean testicular volume	NS (p>0.05)
PFOS			
Buck Louis et al. 2015 General population (n=96 Michigan and 366 in Texas)	19.15 and 21.6 ng/mL (median PFOS in Michigan and Texas)	Sperm viability	NS (p>0.05)
		Sperm count	NS (p>0.05)
		Sperm motility ↑ distance travelled	Association (p<0.05)*
		Other parameters	NS (p>0.05)
		Sperm morphology	NS (p<0.05)
		Joensen et al. 2013 General population (n=247 young men; mean age of 19.6 years)	8.46 ng/mL (mean PFOS)
Sperm concentration	NS (p>0.05)		
Sperm count	NS (p>0.05)		
Percentage progressive motile sperm	NS (p>0.05)		
Kvist et al. 2012 General population (n=588 men)	8.20–51.65 ng/mL (range of mean PFOS) 51.65 ng/mL (mean for Greenland subcohort)		
		Raymer et al. 2012 General population (n=256 men)	37.4 ng/mL (mean PFOS)
Semen pH	NS (p>0.05)		
Sperm motility	NS (p>0.05)		
Sperm concentration	NS (p>0.05)		

2. HEALTH EFFECTS

Table 2-19. Summary of Male Reproductive Outcomes in Humans^a

Reference and study population ^b	Serum perfluoroalkyl level	Outcome evaluated	Result ^c
Toft et al. 2012 General population (n=588 males)	18.4 ng/mL (median PFOS)	Percent motile sperm	NS (p>0.05)
		Sperm concentration	NS (p>0.05)
		Sperm volume	NS (p>0.05)
		Sperm count	NS (p>0.05)
		Percent normal sperm	Inverse association (p<0.05)*
Vested et al. 2013 General population (n=169 males aged 19–21 years)	21.2 ng/mL (median maternal PFOS)	Sperm concentration	NS (p>0.05)
		Total sperm count	NS (p>0.05)
		Semen volume	NS (p>0.05)
		Percentage progressive spermatozoa	NS (p>0.05)
		Percentage morphologically normal spermatozoa	NS (p>0.05)
		Mean testicular volume	NS (p>0.05)
PFHxS			
Joensen et al. 2013 General population (n=247 young men; mean age of 19.6 years)	0.81 ng/mL (mean PFHxS)	Sperm volume	NS (p>0.05)
		Sperm concentration	NS (p>0.05)
		Sperm count	NS (p>0.05)
		Percentage progressive motile sperm	NS (p>0.05)
		Sperm morphology	NS (p>0.05)
Toft et al. 2012 General population (n=588 males)	1.1 ng/mL (median PFHxS)	Percent motile sperm	NS (p>0.05)
		Sperm concentration	NS (p>0.05)
		Sperm volume	NS (p>0.05)
		Sperm count	NS (p>0.05)
		Percent normal sperm	Inverse association (p<0.05)*

2. HEALTH EFFECTS

Table 2-19. Summary of Male Reproductive Outcomes in Humans^a

Reference and study population ^b	Serum perfluoroalkyl level	Outcome evaluated	Result ^c
PFNA			
Buck Louis et al. 2015 General population (n=96 Michigan and 366 in Texas)	1.0 and 1.65 ng/mL (median PFNA in Michigan and Texas)	Sperm viability	NS (p>0.05)
		Sperm count	NS (p>0.05)
		Sperm motility	NS (p>0.05)
		Sperm morphology	
		↑ percentage of normal sperm	Association (p<0.05)*
		↓ percentage sperm with coiled tails	Association (p<0.05)*
Other parameters	NS (p<0.05)		
Joensen et al. 2013 General population (n=247 young men; mean age of 19.6 years)	1.23 ng/mL (mean PFNA)	Sperm volume	NS (p>0.05)
		Sperm concentration	NS (p>0.05)
		Sperm count	NS (p>0.05)
		Percentage progressive motile sperm	NS (p>0.05)
		Sperm morphology	NS (p>0.05)
		Other parameters	NS (p>0.05)
Toft et al. 2012 General population (n=588 males)	1.2 ng/mL (median PFNA)	Percent motile sperm	NS (p>0.05)
		Sperm concentration	NS (p>0.05)
		Sperm volume	NS (p>0.05)
		Sperm count	NS (p>0.05)
		Percent normal sperm	NS (p>0.05)
		Other parameters	NS (p>0.05)
PFDeA			
Buck Louis et al. 2015 General population (n=96 Michigan and 366 in Texas)	0.3 and 0.5 ng/mL (median PFDeA in Michigan and Texas)	Sperm viability	NS (p>0.05)
		Sperm count	NS (p>0.05)
		Sperm motility	NS (p>0.05)
		Sperm morphology	
		↑ sperm head length	Association (p<0.05)*
		↓ percentage sperm with coiled tails	Association (p<0.05)*
Other parameters	NS (p<0.05)		

2. HEALTH EFFECTS

Table 2-19. Summary of Male Reproductive Outcomes in Humans^a

Reference and study population ^b	Serum perfluoroalkyl level	Outcome evaluated	Result ^c
Joensen et al. 2013 General population (n=247 young men; mean age of 19.6 years)	0.38 ng/mL (mean PFDeA)	Sperm volume	NS (p>0.05)
		Sperm concentration	NS (p>0.05)
		Sperm count	NS (p>0.05)
		Percentage progressive motile sperm	NS (p>0.05)
		Sperm morphology	NS (p>0.05)
Me-PFOSA-AcOH			
Buck Louis et al. 2015 General population (n=96 Michigan and 366 in Texas)	0.4 and 0.25 ng/mL (median Me-PFOSA-AcOH in Michigan and Texas)	Sperm viability	NS (p>0.05)
		Sperm count	NS (p>0.05)
		Sperm motility	NS (p>0.05)
		Sperm morphology ↑ percentage of neck/midpiece abnormalities	Association (p<0.05)*
		↑ immature sperm Other parameters	Association (p<0.05)* NS (p<0.05)

^aSee the *Supporting Document for Epidemiological Studies for Perfluoroalkyls*, Table 12 for more detailed descriptions of studies.

^bParticipants in occupational exposure may have also lived near the site and received residential exposure; community exposure studies involved subjects living near PFOA facilities with known exposure to high levels of PFOA.

^cAsterisk indicates association with perfluoroalkyl compound; unless otherwise specified, values in parenthesis are 95% confidence intervals.

Me-PFOSA-AcOH = 2-(N-methyl-perfluorooctane sulfonamide) acetic acid; NS = not significant; PFDeA = perfluorodecanoic acid; PFHxS = perfluorohexane sulfonic acid; PFNA = perfluorononanoic acid; PFOA = perfluorooctanoic acid; PFOS = perfluorooctane sulfonic acid

2. HEALTH EFFECTS

Table 2-20. Summary of Female Reproductive Outcomes in Humans^a

Reference and study population ^b	Serum perfluoroalkyl level	Outcome evaluated	Result ^c
PFOA			
Dhingra et al. 2016a	>2,130 ng/mL·year (cumulative PFOA exposure 5 th quintile)	Menopause age	HR 1.11 (0.97–1.26, p=0.14), 5 th quintile
Community (C8) (n=8,759; retrospective analysis)		Early menopause risk	NS (p=0.45), 5-year lag NS (p=0.58), 10-year lag NS (p=0.57), 15-year lag NS (p=0.20), 20-year lag
Dhingra et al. 2016a	>4,670 ng/mL·year (cumulative PFOA exposure 5 th quintile)	Menopause age (cumulative)	HR 1.10 (0.84–1.43, p=0.51), 5 th quintile
Community (C8) (n=3,334, prospective analysis)	>80.8 ng/mL (measured 5 th PFOA quintile)	Menopause age (measured)	HR 1.12 (0.86–1.45, p=0.40), 5 th quintile
Knox et al. 2011b	11.3–19.8 ng/mL (2 nd PFOA quintile)	Early menopause risk (menopausal subgroup)	OR 1.5 (1.1–2.1)*, 2nd quintile
Community (C8) (n=25,957)		Early menopause risk (perimenopausal subgroup)	OR 1.4 (1.1–1.8)*, 2nd quintile
Buck Louis et al. 2012	2.65 and 2.15 ng/mL (geometric mean PFOA in women with or without endometriosis)	Endometriosis	OR 1.89 (1.17–3.06)*, without parity adjustment OR 1.62 (0.99–2.66), with parity adjustment
General population (n=473)		Risk of moderate to severe endometriosis	OR 2.58 (1.18–5.64)*, without parity adjustment OR 1.86 (0.81–4.24) with parity adjustment
Fei et al. 2010	3.91–5.20 ng/mL (2 nd quartile for maternal PFOA)	Breastfeeding duration ≤3 months	OR 1.98 (1.17–3.24)*, 2nd quartile
General population (n=1,347 pregnant women)		Breastfeeding duration ≤6 months	OR 1.88 (1.31–2.72)*, 2nd quartile

2. HEALTH EFFECTS

Table 2-20. Summary of Female Reproductive Outcomes in Humans^a

Reference and study population ^b	Serum perfluoroalkyl level	Outcome evaluated	Result ^c
Lyngsø et al. 2014 General population (n=1,623 pregnant women)	1.5 ng/mL (median PFOA)	Irregular menstrual cycle	OR 1.4 (0.9–2.2)
		Long menstrual cycle	OR 1.7 (1.1–2.6)*
		Short menstrual cycle	OR 0.7 (0.3–1.5)
Romano et al. 2016 General population (n=336 women)	5.5–7.6 ng/mL (maternal 3 rd quartile PFOA)	Breastfeeding duration ≤3 months	RR 1.63 (1.16–2.28)*, 3rd quartile
		Breastfeeding duration ≤6 months	RR 1.38 (1.06–1.79)*, 3rd quartile
Taylor et al. 2014 General population (n=2,151 women)	>2.5–4.4 and >4.4 ng/mL (2 nd and 3 rd PFOA tertiles)	Menopause	HR 1.36 (1.05–1.75)*, 3rd tertile
		Hysterectomy	HR 1.83 (1.31–2.56)*, 2nd tertile
Vagi et al. 2014 General population (n=52 cases and 50 controls)	4.1 and 2.3 ng/mL (geometric mean PFOA for cases and controls)	Polycystic ovary syndrome risk	OR 6.93 (1.79–29.92, p=0.003)*, 3rd tertile
PFOS			
Knox et al. 2011b Community (C8) (n=25,957)	11.9–17.0 and 17.1–22.4 ng/mL (2 nd and 3 rd PFOS quintiles)	Early menopause risk (menopausal subgroup)	OR 1.5 (1.1–2.1)*, 2nd quintile
		Early menopause risk (perimenopausal subgroup)	OR 1.1 (1.1–1.8)*, 3rd quintile
Buck Louis et al. 2012 General population (n=473)	7.20 and 6.11 ng/mL (geometric mean PFOS in women with or without endometriosis)	Endometriosis	OR 1.39 (0.98–1.98), without parity adjustment OR 1.25 (0.87–1.80), with parity adjustment
		Risk of moderate to severe endometriosis	OR 1.86 (1.05–3.30)*, without parity adjustment OR 1.50 (0.82–2.74) with parity adjustment
Fei et al. 2010 General population (n=1,347 pregnant women)	3.91–5.20 ng/mL (2 nd quartile for maternal PFOA)	Breastfeeding duration ≤3 months	OR 1.89 (1.19–3.01)*, 4th quartile
		Breastfeeding duration ≤6 months	OR 1.56 (1.10–2.22)*, 2nd quartile

2. HEALTH EFFECTS

Table 2-20. Summary of Female Reproductive Outcomes in Humans^a

Reference and study population ^b	Serum perfluoroalkyl level	Outcome evaluated	Result ^c
Lyngsø et al. 2014 General population (n=1,623 pregnant women)	8.0 ng/mL (median PFOS)	Irregular menstrual cycle	OR 1.0 0.6–1.6)
		Long menstrual cycle	OR 0.7 (0.4–1.2)
		Short menstrual cycle	OR 0.7 (0.3–1.5)
Romano et al. 2016 General population (n=336 women)	13.9 ng/mL (maternal median PFOS)	Breastfeeding duration ≤3 months	NS (p=0.065 for trend)
		Breastfeeding duration ≤6 months	NS (p=0.111 for trend)
Taylor et al. 2014 General population (n=2,151 women)	>9–18.4 and >18.4 ng/mL (2 nd and 3 rd PFOS tertiles)	Menopause	HR 1.16 (0.91–1.48), 3 rd tertile
		Hysterectomy	HR 1.44 (1.12–1.85)*, 2nd tertile
Vagi et al. 2014 General population (n=52 cases and 50 controls)	8.2 and 4.9 ng/mL (geometric mean PFOS for cases and controls)	Polycystic ovary syndrome risk	OR 5.79 (1.58–24.12, p=0.005)*, 3rd tertile
PFHxS			
Buck Louis et al. 2012 General population (n=473)	0.48 and 0.43 ng/mL (geometric mean PFHxS in women with or without endometriosis)	Endometriosis	OR 1.14 (0.58–2.24), without parity adjustment OR 0.85 (0.42–1.73), with parity adjustment
		Risk of moderate to severe endometriosis	OR 2.12 (0.85–5.27), without parity adjustment OR 1.24 (0.47–3.31) with parity adjustment
Romano et al. 2016 General population (n=336 women)	1.5 ng/mL (maternal median PFHxS)	Breastfeeding duration ≤3 months	NS (p=0.124 for trend)
		Breastfeeding duration ≤6 months	NS (p=0.087 for trend)
Taylor et al. 2014 General population (n=2,151 women)	>0.9–1.8 and >1.8 ng/mL (2 nd and 3 rd PFHxS tertiles)	Menopause	HR 1.42 (1.08–7.87)*, 2nd tertile
		Hysterectomy	HR 2.22 (1.66–2.98)*, 2nd tertile

2. HEALTH EFFECTS

Table 2-20. Summary of Female Reproductive Outcomes in Humans^a

Reference and study population ^b	Serum perfluoroalkyl level	Outcome evaluated	Result ^c
Vagi et al. 2014 General population (n=52 cases and 50 controls)	1.1 and 0.7 ng/mL (geometric mean PFHxS for cases and controls)	Polycystic ovary syndrome risk	OR 1.20 (0.35–4.07), 3 rd tertile
PFNA			
Buck Louis et al. 2012 General population (n=473)	0.69 and 0.58 ng/mL (geometric mean PFNA in women with or without endometriosis)	Endometriosis	OR 2.20 (1.02–4.75)*, without parity adjustment OR 1.99, 0.91–4.33), with parity adjustment
		Risk of moderate to severe endometriosis	OR 1.21 (0.35–4.19), without parity adjustment OR 0.99 (0.27–3.65) with parity adjustment
Romano et al. 2016 General population (n=336 women)	0.9 ng/mL (maternal median PFNA)	Breastfeeding duration ≤3 months	NS (p=0.591 for trend)
		Breastfeeding duration ≤6 months	NS (p=0.349 for trend)
Taylor et al. 2014 General population (n=2,151 women)	>0.80–1.5 and >1.5 ng/mL (2 nd and 3 rd PFNA tertiles)	Menopause	HR 1.47 (1.14–1.90)*, 3rd tertile
		Hysterectomy	HR 1.39 (1.08–1.80)*, 2nd tertile
Vagi et al. 2014 General population (n=52 cases and 50 controls)	1.2 and 0.9 ng/mL (geometric mean PFNA for cases and controls)	Polycystic ovary syndrome risk	OR 2.25 (0.67–8.00), 3 rd tertile

2. HEALTH EFFECTS

Table 2-20. Summary of Female Reproductive Outcomes in Humans^a

Reference and study population ^b	Serum perfluoroalkyl level	Outcome evaluated	Result ^c
PFDeA			
Buck Louis et al. 2012	0.20 and 0.18 ng/mL (geometric mean PFDeA in women with or without endometriosis)	Endometriosis	OR 2.95 (0.72–12.1), without parity adjustment
General population (n=473)			OR 2.60 (0.62–10.9), with parity adjustment
		Risk of moderate to severe endometriosis	OR 0.72 (0.06–8.09), without parity adjustment OR 0.58 (0.04–7.42) with parity adjustment

^aSee the *Supporting Document for Epidemiological Studies for Perfluoroalkyls*, Table 12 for more detailed descriptions of studies.

^bParticipants in occupational exposure may have also lived near the site and received residential exposure; community exposure studies involved subjects living near PFOA facilities with known exposure to high levels of PFOA.

^cAsterisk indicates association with perfluoroalkyl compound; unless otherwise specified, values in parenthesis are 95% confidence intervals.

HR = hazard ratio; OR = odds ratio; NS = not significant; PFDeA = perfluorodecanoic acid; PFHxS = perfluorohexane sulfonic acid; PFNA = perfluorononanoic acid; PFOA = perfluorooctanoic acid; PFOS = perfluorooctane sulfonic acid; RR = risk ratio

2. HEALTH EFFECTS

Table 2-21. Summary of Fertility Outcomes in Humans^a

Reference and study population ^b	Serum perfluoroalkyl level	Outcome evaluated	Result ^c
PFOA			
Bach et al. 2015a	2.0 ng/ml (median maternal PFOA)	Fecundability	FR 1.00 (0.99–1.01), per 0.1 ng/mL
General population (n=1,372 pregnant women)		Infertility risk	OR 1.00 (0.98–1.01), per 0.1 ng/mL
Bach et al. 2015b, 2015c	5.6–7.7 ng/mL (4 th PFOA quartile)	Fecundability	FR 0.86 (0.63–1.19), 4 th quartile
General population (n=440 pregnant women)		Parous subgroup	FR 0.74 (0.48–1.13), 4 th quartile
		Nulliparous subgroup	FR 0.99 (0.64–1.54), 4 th quartile
		Infertility	OR 1.67 (0.70–4.00), 4 th quartile
		Parous subgroup	OR 1.74 (0.46–6.55), 4 th quartile
		Nulliparous subgroup	OR 1.56 (0.55–4.42), 4 th quartile
Bach et al. 2015b, 2015c (re-analysis of Fei et al. 2009, 2012 data)	4.1–5.4 ng/mL (2 nd PFOA quartile)	Fecundability	FR 0.78 (0.65–0.94)*, 2nd quartile
General population (n=1,161 pregnant women)		Parous subgroup	FR 0.76 (0.59–0.96)*, 2nd quartile
		Nulliparous subgroup	FR 0.74 (0.56–0.98)*, 4th quartile
	7.2–41.5 ng/mL (4 th PFOA quartile)	Infertility	OR 1.91 (1.16–3.13)*, 2nd quartile
		Parous subgroup	OR 2.30 (1.09–4.87)*, 2nd quartile
		Nulliparous subgroup	OR 1.48 (0.80–2.75), 4 th quartile
Fei et al. 2009	3.91–5.20 ng/mL (2 nd PFOA quartile, maternal)	Fecundability	FOR 0.72 (0.57–0.90)*, 2nd quartile
General population (n=1,240 pregnant women)		Infertility	OR 2.06 (1.22–3.51)*, 2nd quartile
Fei et al. 2012 (re-analysis of Fei et al. 2009 data)	3.91–5.20 and ≥6.97 ng/mL (2 nd and 4 th PFOA quartiles, maternal)	Fecundability	
General population (n=1,240 pregnant women)		Parous subgroup	FOR 0.61 (0.46–0.80)*, 2nd quartile
		Nulliparous subgroup	FOR 0.63 (0.39–1.04), 4 th quartile
		Infertility	
		Parous subgroup	OR 3.39 (1.75–6.53)*, 2nd quartile
		Nulliparous subgroup	OR 1.30 (0.52–3.21; p=0.082 for trend), 4 th quartile
Jørgensen et al. 2014a, 2014b	1.65 ng/mL (median PFOA)	Fecundability	FR 1.04 (0.87–1.25)
General population (n=938 pregnant women)		Primiparous subgroup	FR 1.31 (1.03–1.68)*
		Infertility	OR 1.11 (0.74–1.66)
Vélez et al. 2015	1.7 ng/mL (median maternal PFOA)	Fecundability	FOR 0.89 (0.83–0.94, p<0.001)*
General population (n=1,743 pregnant women)		Infertility	OR 1.31 (1.11–1.53, p=0.001)*

2. HEALTH EFFECTS

Table 2-21. Summary of Fertility Outcomes in Humans^a

Reference and study population ^b	Serum perfluoroalkyl level	Outcome evaluated	Result ^c
Vestergaard et al. 2012 General population (n=222 nulliparous couples)	5.58 and 5.61 ng/mL (median PFOA in women with no pregnancy and pregnant)	Fecundability	OR 1.18 (0.78–1.78)
		Not becoming pregnant within first six cycles	OR 1.21 (0.67–2.18)
Whitworth et al. 2012b General population (n=416 subfecund pregnant women and 474 controls)	1.66–2.24, 2.25–3.02, and ≥3.02 ng/mL (2 nd , 3 rd , and 4 th PFOA quartiles)	Infertility	OR 1.6 (1.1–2.3)*, 2nd quartile
		Parous subgroup Primiparous subgroup	OR 2.4 (1.4–4.1)*, 3rd quartile OR 0.5 (0.2–1.2), 4 th quartile
PFOS			
Bach et al. 2015a General population (n=1,372 pregnant women)	8.3 ng/ml (median maternal PFOS) 10.85–36.10 ng/mL (4 th PFOS quartile)	Fecundability	FR 1.09 (0.92–1.30), 4 th quartile
		Infertility risk	OR 0.71 (0.47–1.07), 4 th quartile
Bach et al. 2015b, 2015c General population (n=440 pregnant women)	36.3–103.8 ng/mL (4 th PFOS quartile)	Fecundability	FR 0.96 (0.75–1.24), 4 th quartile
		Parous subgroup	FR 1.04 (0.70–1.55), 4 th quartile
		Nulliparous subgroup	FR 0.97 (0.62–1.51), 4 th quartile
		Infertility	OR 1.03 (0.54–2.00), 4 th quartile
Bach et al. 2015b, 2015c (re-analysis of Fei et al. 2009, 2012 data) General population (n=1,161)	27.0–34.2, 34.3–43.8, and 43.9–106.7 ng/mL (2 nd , 3 rd , and 4 th PFOS quartiles)	Fecundability	FR 0.79 (0.66–0.95)*, 2nd quartile
		Parous subgroup	FR 0.90 (0.70–1.14), 4 th quartile
		Nulliparous subgroup	FR 0.68 (0.52–0.91)*, 3rd quartile
		Infertility	OR 1.65 (1.01–2.68)*, 2nd quartile
Fei et al. 2009 General population (n=1,240 pregnant women)	26.1–33.3 ng/mL (2 nd PFOS quartile, maternal)	Parous subgroup	OR 1.60 (0.78–3.28), 4 th quartile
		Nulliparous subgroup	OR 2.71 (1.38–5.30)*, 3rd quartile
		Fecundability	OR 0.70 (0.56–0.87)*, 2nd quartile
		Infertility	OR 1.70 (1.01–2.86)*, 2nd quartile

2. HEALTH EFFECTS

Table 2-21. Summary of Fertility Outcomes in Humans^a

Reference and study population ^b	Serum perfluoroalkyl level	Outcome evaluated	Result ^c
Fei et al. 2012 (re-analysis of Fei et al. 2009 data)	26.1–33.3 and 33.4–43.2 ng/mL (2 nd and 3 rd PFOS quartiles, maternal)	Fecundability Parous subgroup Nulliparous subgroup	NS (p=0.32 for trend) FOR 0.63 (0.43–0.91)*, 3rd quartile
General population (n=1,240 pregnant women)		Infertility Parous subgroup Nulliparous subgroup	NS (p=0.26 for trend) OR 2.50 (1.16–5.37, p=0.36 for trend)*, 3rd quartile
Jørgensen et al. 2014a, 2014b	10.60 ng/mL (median PFOS)	Fecundability	FR 0.90 (0.76–1.07)
General population (n=938 pregnant women)		Infertility	OR 1.39 (0.93–2.07)
Vélez et al. 2015	4.7 ng/mL (median maternal PFOS)	Fecundability	FOR 0.96 (0.91–1.02, p=0.17)
General population (n=1,743 pregnant women)		Infertility	OR 1.14 (0.98–1.34, p=0.09)
Vestergaard et al. 2012	35.75 and 36.29 ng/mL (median PFOS in women with no pregnancy and pregnant)	Fecundability	NS (p=0.29)
General population (n=222 nulliparous couples)		Not becoming pregnant within first six cycles	OR 0.98 (0.54–1.77)
Whitworth et al. 2012b	10.34–16.60 and ≥16.61 ng/mL (3 rd and 4 th PFOS quartile)	Infertility Parous subgroup Primiparous subgroup	OR 1.4 (1.0–2.0)*, 3rd quartile OR 2.1 (1.2–3.8)*, 4th quartile OR 0.7 (0.4–1.3), 4 th quartile
General population (n=416 subfecund women and 474 controls)			
PFHxS			
Bach et al. 2015a	0.5 ng/ml (median maternal PFHxS)	Fecundability	FR 1.00 (0.99–1.01), per 0.1 ng/mL
General population (n=1,372 pregnant women)		Infertility risk	OR 0.98 (0.93–1.03), per 0.1 ng/mL
Jørgensen et al. 2014a, 2014b	1.94 ng/mL (median PFHxS)	Fecundability	FR 0.97 (0.85–1.11)
General population (n=938 pregnant women)		Infertility	OR 0.99 (0.73–1.33)
Vélez et al. 2015	1 ng/mL (median maternal PFHxS)	Fecundability	FOR 0.91 (0.86–0.97, p=0.002)*
General population (n=1,743 pregnant women)		Infertility	OR 1.27 (1.09–1.48, p=0.003)*

2. HEALTH EFFECTS

Table 2-21. Summary of Fertility Outcomes in Humans^a

Reference and study population ^b	Serum perfluoroalkyl level	Outcome evaluated	Result ^c
Vestergaard et al. 2012	1.12 and 1.22 ng/mL (median PFHxS in women with no pregnancy and pregnant)	Fecundability	OR 1.33 (1.01–1.75)*
General population (n=222 nulliparous couples)		Not becoming pregnant within first six cycles	OR 0.67 (0.37–1.20)
PFNA			
Bach et al. 2015a	0.8 ng/mL (median maternal)	Fecundability	FR 1.00 (0.98–1.02), per 0.1 ng/mL
General population (n=1,372 pregnant women)		Infertility risk	OR 0.99 (0.95–1.03), per 0.1 ng/mL
Jørgensen et al. 2014a, 2014b	0.64 ng/mL (median PFNA)	Fecundability	FR 0.80 (0.69–0.94)*
General population (n=938 pregnant women)		Primiparous subgroup	FR 0.99 (0.88–1.22)
		Infertility	OR 1.53 (1.08–2.15)*
Vestergaard et al. 2012	0.45 and 0.51 ng/mL (median PFNA in women with no pregnancy and pregnant)	Fecundability	OR 1.17 (0.88–1.54)
General population (n=222 nulliparous couples)		Not becoming pregnant within first six cycles	OR 0.67 (0.37–1.25)
PFDeA			
Bach et al. 2015a	0.3 ng/mL (median maternal PFDeA)	Fecundability	FR 1.00 (0.97–1.03), per 0.1 ng/mL
General population (n=1,372 pregnant women)		Infertility risk	OR 0.99 (0.92–1.07), per 0.1 ng/mL
Vestergaard et al. 2012	0.10 and 0.11 ng/mL (median PFDeA in women with no pregnancy and pregnant)	Fecundability	OR 1.15 (0.89–1.49)
General population (n=222 nulliparous couples)		Not becoming pregnant within first six cycles	OR 0.61 (0.33–1.12)
PFUA			
Bach et al. 2015a	0.3 ng/mL (median maternal PFUA)	Fecundability	FR 1.01 (0.98–1.03), per 0.1 ng/mL
General population (n=1,372 pregnant women)		Infertility risk	OR 0.98 (0.92–1.04), per 0.1 ng/mL
PFOSA			
Vestergaard et al. 2012	0.10 and 0.11 ng/mL (median PFOSA in women with no pregnancy and pregnant)	Fecundability	OR 1.01 (0.86–1.18)
General population (n=222 nulliparous couples)		Not becoming pregnant within first six cycles	OR 0.81 (0.45–1.46)

2. HEALTH EFFECTS

Table 2-21. Summary of Fertility Outcomes in Humans^a

Reference and study population ^b	Serum perfluoroalkyl level	Outcome evaluated	Result ^c
Me-PFOSA-AcOH			
Vestergaard et al. 2012	0.45 and 0.39 ng/mL	Fecundability	OR 0.99 (0.82--1.18)
General population (n=222 nulliparous couples)	(median Me-PFOSA-AcOH in women with no pregnancy and pregnant)	Not becoming pregnant within first six cycles	OR 1.23 (0.68--2.20)
Et-PFOSA-AcOH			
Vestergaard et al. 2012	2.12 and 1.79 ng/mL	Fecundability	OR 0.79 (0.62--1.00)
General population (n=222 nulliparous couples)	(median Et-PFOSA-AcOH in women with no pregnancy and pregnant)	Not becoming pregnant within first six cycles	OR 1.53 (0.85--2.77)

^aSee the *Supporting Document for Epidemiological Studies for Perfluoroalkyls*, Table 12 for more detailed descriptions of studies.

^bParticipants in occupational exposure may have also lived near the site and received residential exposure; community exposure studies involved subjects living near PFOA facilities with known exposure to high levels of PFOA.

^cAsterisk indicates association with perfluoroalkyl compound; unless otherwise specified, values in parenthesis are 95% confidence intervals.

Et-PFOSA-AcOH = 2-(N-ethyl-perfluorooctane sulfonamide) acetic acid; FOR = fecundability odds ratio; FR = fecundability ratio (probability of conceiving during a given menstrual cycle); OR = odds ratio; Me-PFOSA-AcOH = 2-(N-methyl-perfluorooctane sulfonamide) acetic acid; NS = not significant; PFDeA = perfluorodecanoic acid; PFHxS = perfluorohexane sulfonic acid; PFNA = perfluorononanoic acid; PFOA = perfluorooctanoic acid; PFOS = perfluorooctane sulfonic acid; PFOSA = perfluorooctane sulfonamide; PFUA = perfluoroundecanoic acid

2. HEALTH EFFECTS

are presented in Tables 2-1, 2-3, 2-4, 2-5, and 2-6 and in Figures 2-4, 2-6, 2-7, and 2-8. Multigeneration studies on PFOA, PFOS, and PFBuS have not found alterations in reproductive parameters in animals; similarly, no effect on fertility was observed for PFHxS. An increase in the incidence of Leydig cell hyperplasia (reclassified as gonadal stromal hyperplasia) has been observed in animals exposed to PFOA; one study for PFDoA reported ultrastructural alterations in the testes. Studies on PFOS, PFHxS, PFBuS, and PFBA have not found histological alterations. Delays in mammary gland development have been observed in mice exposed to PFOA; this effect has also been observed in perinatally exposed mice (see Section 2.17, Developmental).

PFOA

Epidemiology Studies—Reproductive Hormone Levels. Two studies have evaluated potential effects of PFOA exposure on reproductive hormone levels in workers (Olsen et al. 1998b; Sakr et al. 2007b). Sakr et al. (2007b) found associations between serum PFOA and estradiol and testosterone levels male workers at the Washington Works facility. In contrast, Olsen et al. (1998b) did not find associations between serum PFOA and estradiol or testosterone in male workers at the 3M Cottage Grove facility. The study did find an association with prolactin levels, but this was only found in workers examined in 1993, but not in those examined in 1995. In a general population study of men aged 30–66 years of age, correlations were found between serum PFOA levels and free testosterone levels and LH levels; no correlations were found for estradiol, prolactin, follicle stimulating hormone (FSH), or total testosterone levels (Raymer et al. 2012). Another study of similar aged men did not find an association between serum PFOA and sex hormone binding globulin levels (Specht et al. 2012). Studies of young men (median age 19 years) (Joensen et al. 2013) or adolescents and young men (12–30 years of age) (Tsai et al. 2015) did not find associations between serum PFOA and reproductive hormone levels. A third study (Vested et al. 2013) found an association between LH and FSH levels and maternal serum PFOA levels in young adult males; other hormones were not affected.

Two studies of women (Barrett et al. 2015; Knox et al. 2011b) did not find associations with estradiol levels or luteal progesterone levels. A third study of adolescent and young women (Tsai et al. 2015) found an association between serum PFOA and sex hormone binding globulin levels in adolescents (12–17 years), but not in young adults; no associations with FSH or testosterone were observed in either group.

2. HEALTH EFFECTS

Epidemiology Studies—Effects on Sperm. Six general population studies have evaluated the potential alterations in sperm parameters associated with PFOA exposure. Although some associations have been found, the results are not consistent across studies. Buck Louis et al. (2015) reported an increase in curvilinear velocity and some alterations in sperm morphology that were associated with serum PFOA levels. Toft et al. (2012) found a PFOA-related increase in the percentage motile sperm in men with serum PFOA levels in the 3rd tertile. Vested et al. (2013) reported inverse associations between maternal serum PFOA levels and sperm concentration and total sperm count in young adults; no alterations in motility or morphology were observed. Other studies did not find alterations in sperm viability, count, concentration, motility, or morphology (Buck Louis et al. 2015; Joensen et al. 2013; Raymer et al. 2012; Toft et al. 2012) or the Y-X chromosome ratio (Kvist et al. 2012).

Epidemiology Studies—Effects on Menstrual Cycle Length, Menopause Onset, Endometriosis, and Breastfeeding Duration. One study examined possible associations between serum PFOA levels and alterations in menstrual cycle length (Lyngsø et al. 2014). An increased risk of a long menstrual cycle (≥ 32 days) was observed in women with serum PFOA levels in the 3rd tertile and when serum PFOA was used as a continuous variable. No alterations in the risk of having a short menstrual cycle (≤ 24 days) or irregular menstrual cycles (≥ 7 days difference between cycles) were observed. Four studies have evaluated the risk of early menopause. In a study of C8 Health Study participants, increases in the risk of early menopause was observed in perimenopausal (>42 – ≤ 51 years of age) and menopausal (>51 – ≤ 65 years of age) women with serum PFOA levels in the 2nd, 3rd, 4th, and 5th quintiles (Knox et al. 2011b). An increase in menopause risk was also observed in a cross-sectional study of NHANES participants with serum PFOA levels in the 3rd tertile (Taylor et al. 2014). Taylor et al. (2014) also found a higher risk of hysterectomy among women with serum PFOA levels in the 2nd and 3rd tertiles. An analysis by Taylor et al. (2014) of possible reverse causality showed that serum PFOA levels increased after menopause. In contrast, no alterations in the risk of early menopause or age of menopause were associated with cumulative serum PFOA levels in retrospective and prospective studies of C8 Health Study participants (Dhingra et al. 2016a); age of menopause was also not associated with measured serum PFOA levels in the prospective study (Dhingra et al. 2016a). Buck Louis et al. (2012) showed that the risk of endometriosis and the risk of moderate-to-severe endometriosis were associated with serum PFOA levels; however, adjustment for parity resulted in confidence intervals that included unity. A case-control study (Vagi et al. 2014) found an increased risk of polycystic ovary syndrome among women with serum PFOA levels in the 3rd tertile.

2. HEALTH EFFECTS

Two studies have evaluated a possible link between maternal PFOA levels and breastfeeding duration. Both studies found increases in the risk of breastfeeding ≤ 3 or 6 months that were associated with maternal PFOA levels (Fei et al. 2010; Romano et al. 2016). When the women were segregated by parity, the associations were only found in multiparous women (Fei et al. 2010). This finding may be due to reverse causality since shorter breastfeeding would likely result in lower maternal transfer of PFOA.

Epidemiology Studies—Effects on Fertility. Several general population studies have examined the possible association between female serum PFOA levels and decreased fertility or infertility; the results are graphically presented in Figures 2-29 and 2-30, respectively. With the exception of the Vestergaard et al. (2012) study, all of the women were pregnant; thus, couples with unresolved infertility are underrepresented in these analyses. No studies were identified that used paternal serum PFOA levels as the biomarker of exposure. Most of the studies evaluated two aspects of fertility: fecundability, which is a measure of time to pregnancy, and risk of infertility, which is typically time to pregnancy of >12 months.

In a study of pregnant women participating in the Danish National Birth Cohort study, a decrease in fecundability and an increase in infertility were observed in women with serum PFOA (measured at gestation week 12) levels ≥ 3.91 ng/mL (Fei et al. 2009). When the women were categorized by parity, decreased fecundability OR and increased infertility OR were only found in the parous group; the ORs for the nulliparous women included unity (Fei et al. 2009). A second re-analysis of these data (Bach et al. 2015a) using a different statistical approach confirmed the results of the whole group and the parous subgroup; this re-analysis also found a decrease in the fecundability risk among the nulliparous women. In another set of women participating in the Danish National Birth Cohort study (Bach et al. 2015b), no alterations in fecundability or infertility risk were observed in the whole cohort or when the women were categorized into parous and nulliparous subcohorts. It was noted that the median serum PFOA levels in this second study (4.0 ng/mL) were lower than the levels in the larger study (5.4 ng/mL). A decrease in fecundability and an increase in infertility risk were also observed in a Canadian study of pregnant women (Vélez et al. 2015). An increase in infertility risk was also found in a Norwegian study of subfecund pregnant women with serum PFOA levels in the three highest quartiles (Whitworth et al. 2012b); when the women were categorized based on parity, the infertility risk was only elevated in the parous women with serum PFOA levels in the 3rd and 4th quartiles. A multinational study also found an alteration in fecundability (Jørgensen et al. 2014a); however, this study found that higher serum PFOA levels resulted in a decrease in the time to pregnancy (fecundability ratio >1) among primiparous women.

2. HEALTH EFFECTS

Figure 2-29. Fecundability Relative to PFOA Levels (Presented as Adjusted Fecundability Ratios)

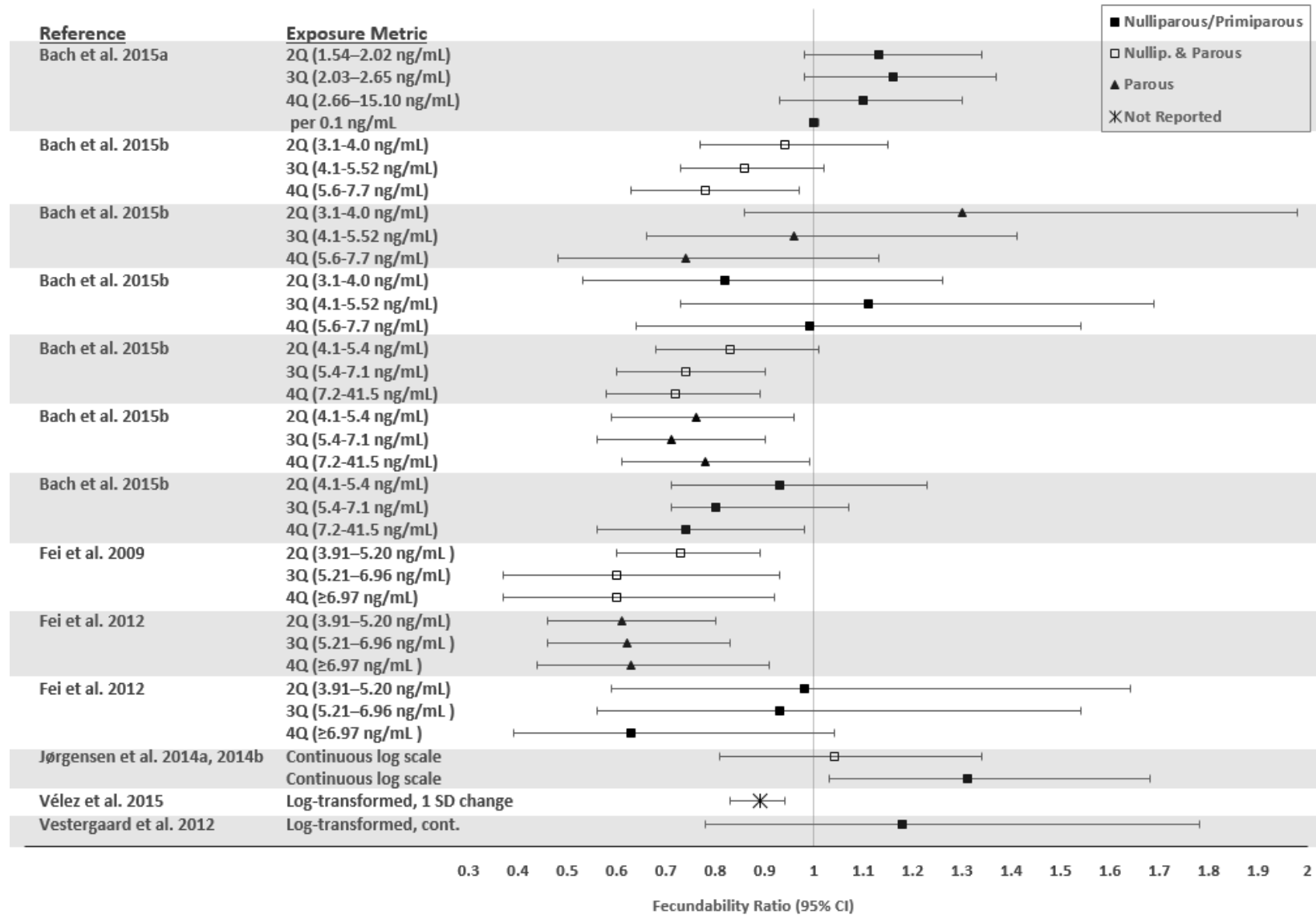

2. HEALTH EFFECTS

Figure 2-30. Infertility Relative to PFOA Levels (Presented as Adjusted Odds Ratios)

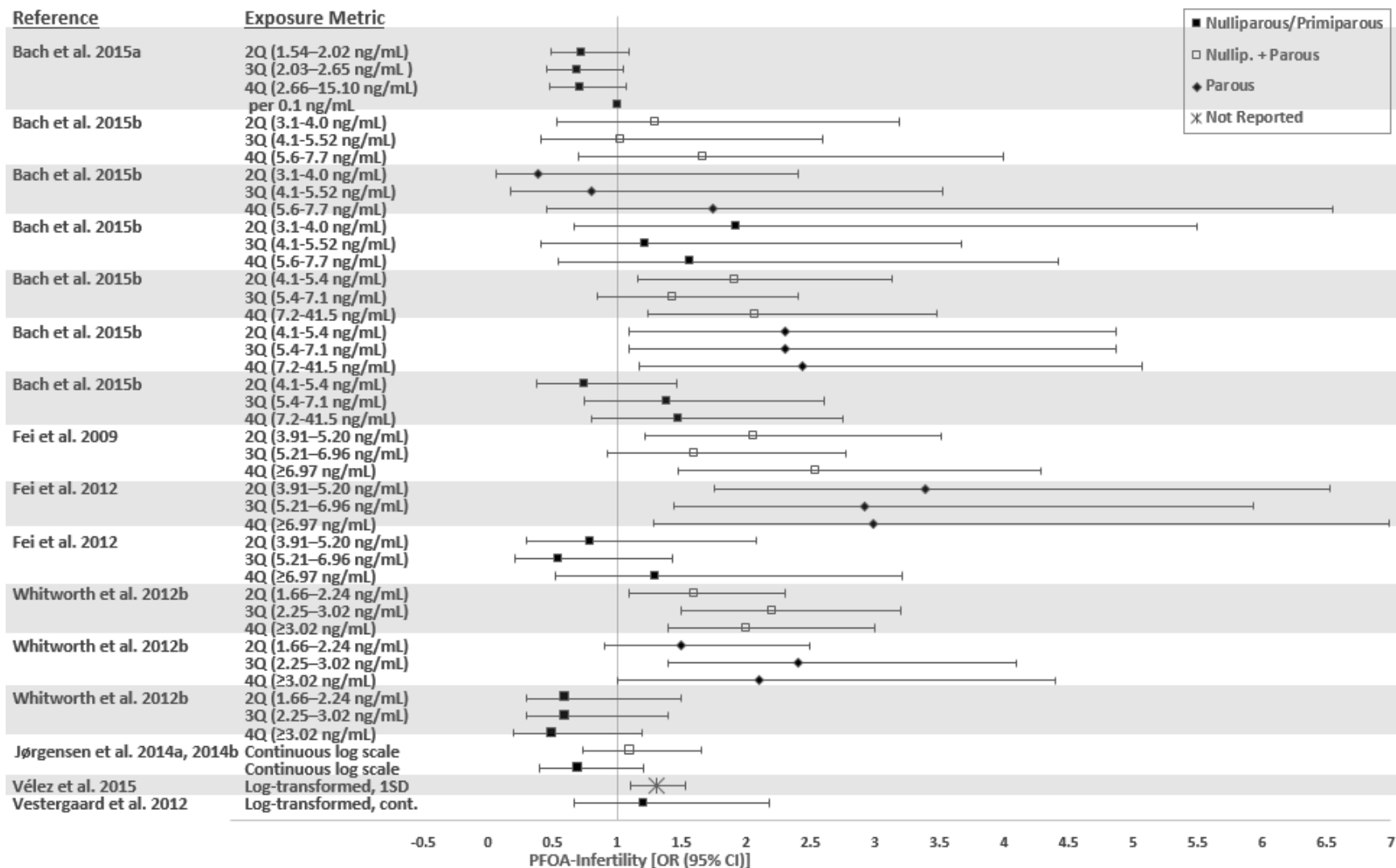

2. HEALTH EFFECTS

Other studies have not found alterations in fecundability and/or infertility (Bach et al. 2015a; Jørgensen et al. 2014a; Vestergaard et al. 2012).

Laboratory Animal Studies. Examination of the testes and epididymides of rats exposed intermittently head-only to up to 84 mg/m³ APFO dusts for 2 weeks did not reveal any gross or microscopic treatment-related alterations (Kennedy et al. 1986).

Several studies have been conducted in rats to examine whether induction of Leydig cells tumors could be due to an endocrine-related mechanism. In a 14-day gavage study in which rats were dosed with up to 50 mg/kg/day PFOA, testes weight was not significantly affected and microscopic examination did not reveal any significant alterations (Cook et al. 1992). However, the weight of the accessory sex organ unit (ventral and dorsal lateral prostate, seminal vesicles, and coagulating glands) was significantly decreased in rats dosed with 25 mg/kg/day PFOA (17% decrease) and 50 mg/kg/day PFOA (18% decrease) relative to controls and to a pair-fed group. There was also a trend for reduced serum and interstitial fluid testosterone in PFOA-treated rats; serum LH was not altered and estradiol was significantly increased (63%) at ≥ 10 mg/kg/day. Challenge experiments conducted with human chorionic gonadotropin, gonadotropin-releasing hormone, or naloxone suggested that the decrease in serum testosterone was due to a lesion at the level of the testes. Serum levels of progesterone and 17 α -hydroxyprogesterone were not altered by 50 mg/kg/day PFOA, but androstenedione levels were reduced 2-fold. The data suggested that the decrease in serum testosterone may be due to a decrease in the conversion of 17 α -hydroxyprogesterone to androstenedione, and this could be attributed to the elevated serum levels of estradiol. The decrease in weight of the accessory sex organ unit could also be attributed to the elevated estradiol serum levels. In a subsequent study from the same group of investigators, rats dosed with 25 mg/kg/day PFOA for 14 days showed a significant increase in estradiol in serum and in testicular interstitial fluid relative to controls (Biegel et al. 1995). Treatment with PFOA for 14 days significantly increased aromatase activity in the liver (aromatase converts testosterone to estradiol), but not in testes, muscle, or adipose tissue, suggesting that PFOA increases serum estradiol by inducing aromatase activity in the liver. Treatment with PFOA also increased testicular interstitial fluid transforming growth factor α (TGF α). Collectively, the results were consistent with the hypothesis that increased estradiol levels ultimately produce Leydig cell hyperplasia and adenoma by acting as a mitogen or enhancing growth factor secretion. A study of the dose-response relationship for PFOA and serum estradiol reported a significant increase in serum estradiol in rats dosed with ≥ 2 mg/kg/day, which was well correlated with total hepatic aromatase activity (Liu et al. 1996). Significant increases in serum estradiol were also

2. HEALTH EFFECTS

reported during the first year of treatment of male rats with 13.6 mg/kg/day PFOA in a 2-year dietary study (Biegel et al. 2001).

Significant increases in the incidence of Leydig cell hyperplasia were observed in rats exposed to 13.6 mg/kg/day PFOA in the diet for 2 years (Biegel et al. 2001). Another 2-year study found an increased incidence of vascular mineralization in the testes of rats exposed to 15 mg/kg/day PFOA in the diet; no effects were observed at 1.5 mg/kg/day (3M 1983). In female rats, increases in the incidence of tubular hyperplasia of the ovaries were observed following a 2-year exposure to 1.5 mg/kg/day (3M 1983). A peer review of the histological slides from 3M (1983) concluded that the more current nomenclature for the tubular hyperplasia was gonadal stromal hyperplasia (Mann and Frame 2004). Additionally, the peer reviewers substantially disagreed with the incidence of lesions in the 1.5 mg/kg/day group and slightly disagreed with the incidence in the 15 mg/kg/day group. Based on the incidence reported by the peer reviewers, no statistically significant increases in the occurrence of gonadal stromal hyperplasia were observed in either group; a significant increase in grade 3 and above lesions were observed in the 15 mg/kg/day group.

In a 2-generation reproduction study in which male and female rats were dosed with up to 30 mg/kg/day PFOA by gavage in water for 70 days before mating and until sacrifice, there were no effects on estrous cycling, sperm number and quality, mating and fertility, or histopathology of the reproductive organs assessed in the parental and F1 generations (Butenhoff et al. 2004b). Intermediate-duration studies of rats and monkeys also did not find gross or microscopic alterations in the sex organs at termination; Cynomolgus monkeys were dosed with up to 20 mg/kg/day PFOA for 4 or 26 weeks (Butenhoff et al. 2002; Thomford 2001), Rhesus monkeys with up to 100 mg/kg/day PFOA for 13 weeks (Griffith and Long 1980), and rats with up to approximately 100–110 mg/kg/day PFOA for 13 weeks (Griffith and Long). Serum levels of estradiol and estriol were not significantly altered in the 4-week study conducted by Thomford (2001), but estrone was reduced in monkeys dosed with 2 and 20 mg/kg/day PFOA; no possible explanation was discussed. In the 26-week study (Butenhoff et al. 2002), no treatment-related alterations were reported in serum estrone, estriol, estradiol, or testosterone, indicating that the reduced serum estrone levels in the 4-week study was transitory. In 2-year dietary studies in rats, doses of 13.6 mg/kg/day PFOA significantly increased the incidence of Leydig cell hyperplasia (Biegel et al. 2001), whereas 15 mg/kg/day increased the incidence of vascular mineralization in the testes and 1.5 mg/kg/day increased the incidence of tubular hyperplasia in the ovaries (3M 1983).

2. HEALTH EFFECTS

A study in pregnant mice dosed with 5 mg/kg/day PFOA (only dose level tested) reported that the mammary gland showed changes suggesting substantial delay (possibly up to 10 days) in gland differentiation on PND 20 and alterations in milk protein gene expression on PND 20 (White et al. 2007). Subsequent studies by this group support the finding of delayed mammary gland differentiation. On PND 1, the mammary glands of mice administered 5 mg/kg/day on GDs 8–17 appeared immature; the morphology was similar to that seen in late pregnancy prior to parturition and the initiation of nursing (White et al. 2009). Another study found that the normal weaning-induced mammary gland involution was compromised on PND 22 in mice exposed to 1 mg/kg/day on GDs 1–17 or 0.001 mg/kg/day administered on GD 7–PND 22 (White et al. 2011); the investigators noted that the mammary gland structure was similar to mammary gland tissue at or near the peak of lactation (PND 10). Necrosis was observed in the placenta of mice administered via gavage 10 or 25 mg/kg/day PFOA on GDs 11–16 (Suh et al. 2011); no alterations were observed at 2 mg/kg/day.

No gross or microscopic alterations were reported in the testes from rats dermally exposed to 2,000 mg/kg/day APFO (Kennedy 1985).

Summary. Epidemiology studies have examined a several types of reproductive endpoints. Due to inconsistent results, the available data are not suitable for determining whether there are associations between serum PFOA and reproductive hormones or effects on sperm. There is some suggestive evidence that increases in serum PFOA levels can result in earlier onset of menopause; however, this is based on the findings of two studies (a third study did not find an association). Several general population studies found associations between serum PFOA and impaired fertility (increased time to pregnancy and/or infertility). The results of a multi-generational study in rats do not suggest that the reproductive system is a sensitive target of PFOA toxicity. Additionally, histological alterations have not been observed in monkeys or rats following intermediate and/or chronic oral exposure.

PFOS

Epidemiology Studies—Reproductive Hormone Levels. In an occupational exposure study of workers at 3M Decatur and Antwerp facilities (Olsen et al. 1998a) and a general population study (Raymer et al. 2012), no associations between serum PFOS and reproductive hormones were found. Studies in adolescent and young adult males have found inverse associations between serum PFOS levels and total and free testosterone levels (Joensen et al. 2013), free androgen index (Joensen et al. 2013), and FSH

2. HEALTH EFFECTS

levels (Tsai et al. 2015). Another study of young men did not find alterations in reproductive hormone levels (Vested et al. 2013).

In a study of females participating in the C8 Health Studies, serum PFOS levels were inversely associated with estradiol levels in both perimenopausal and menopausal women (Knox et al. 2011b). An inverse association with follicular estradiol levels was also observed in a general population study (Barrett et al. 2015); when segregated by parity, the inverse association was only found in nulliparous women. An inverse association between serum PFOS levels and testosterone levels was observed in adolescent females; no association was found in older females (Tsai et al. 2015).

Epidemiology Studies—Effects on Sperm. The available general population data do not provide evidence that PFOS damages sperm. One study (Buck Louis et al. 2015) found an association for one measure of sperm motility (distance travelled) but not for other measures. Another study (Toft et al. 2012) found an inverse association between serum PFOS levels and percentage of normal sperm. Other studies have not found alterations in sperm viability, count, motility, volume, or morphology (Buck Louis et al. 2015; Joensen et al. 2013; Raymer et al. 2012; Toft et al. 2012; Vested et al. 2013). A multinational study (Kvist et al. 2012) found a nonlinear association between serum PFOS and Y-X chromosome ratio; however, when categorized by country, the only significant trend was a negative trend in the Greenland cohort. It is noted that these are studies of individuals exposed to background levels of PFOS, involved a single measurement of PFOS, and are not adequate for establishing causality.

Epidemiology Studies—Effects on Menstrual Cycle Length, Menopause Onset, Endometriosis, and Breastfeeding Duration. No alterations in the risk of irregular, short, or long menstrual cycle lengths associated with serum PFOS levels were observed in a study of pregnant women (Lyngsø et al. 2014). A study of C8 Health Study participants found increases in the risk of early menopause in perimenopausal and menopausal women with serum PFOS levels in the $\geq 3^{\text{rd}}$ and $\geq 2^{\text{nd}}$ quintiles, respectively (Knox et al. 2011b). In contrast, a study of NHANES participants did not find an association between serum PFOS and the risk of early menopause (Taylor et al. 2014). The risk of endometriosis was not associated with serum PFOS levels (Buck Louis et al. 2012). However, there was a greater risk of having moderate to severe endometriosis; adjusting for parity decreased the risk and the CIs included unity. General population studies found increases in the risk of having a hysterectomy in women having serum PFOS levels in the 2nd and 3rd tertiles (Taylor et al. 2014) and the risk of having polycystic ovary syndrome in women with serum PFOS levels in the 3rd tertile (Vagi et al. 2014). Most of these endpoints were only

2. HEALTH EFFECTS

examined in one study and the evidence is inconclusive to determine whether there is an association between PFOS exposure and these female reproductive outcomes.

Maternal serum PFOS levels have been associated with increases in the risk of breastfeeding for ≤ 3 or 6 months (Fei et al. 2010; Romano et al. 2016). When the women were segregated by parity, the associations were only found in multiparous women (Fei et al. 2010). This finding may be due to reverse causality since longer breastfeeding would likely result in lower maternal PFOS levels.

Epidemiology Studies—Effects on Fertility. Several general population studies have evaluated whether there is a possible link between serum PFOS and time-to-pregnancy (as measured using a fecundability ratio) or infertility; graphical presentations of potential associations between fecundability and infertility relative to serum PFOA levels are presented in Figures 2-31 and 2-32, respectively. A couple of studies have found associations, but most have not found associations. Fei et al. (2009) found decreases in fecundability and increases in infertility risk among pregnant women with serum PFOS levels in the top three quartiles. When the women were categorized by parity (Fei et al. 2012), the decrease in fecundability and increase in infertility risk were only observed in nulliparous women with serum PFOS levels in the 3rd and 4th quartiles; no alterations were observed among parous women. A re-analysis of these data using a different statistical approach (Bach et al. 2015b) resulted in the same findings of associations between PFOS and fecundability and infertility. Whitworth et al. (2012b) also found an increased risk of infertility among subfecund women with serum PFOS levels in the 3rd quartile; categorizing by parity resulted in increases in only parous women with serum PFOS levels in the 4th quartile. In contrast, other studies have not found alterations in fecundability or fertility associated with maternal serum PFOS levels (Bach et al. 2015a, 2015b; Jørgensen et al. 2014a; Vélez et al. 2015; Vestergaard et al. 2012).

Laboratory Animal Studies. A significant decrease in serum testosterone levels and epididymal sperm count was observed in mice administered 10 mg/kg/day PFOS for 21 days (Wan et al. 2011). No alterations were observed in mice administered 5 mg/kg/day PFOS or in mice administered 5 or 10 mg/kg/day PFOS for 14 days. No alterations in reproductive performance (number of litters, gestation length, number of implantation sites, or potential resorptions) were observed in rats administered 1 mg/kg/day PFOS throughout gestation and lactation (Buttenoff et al. 2009b). Lee et al. (2015a) did find a decrease in placental weight and placental capacity (ratio of fetal weight to placental weight) in mice administered ≥ 0.5 mg/kg/day PFOS via gavage on GDs 11–16. Multigeneration studies with PFOS in

2. HEALTH EFFECTS

Figure 2-31. Fecundability Relative to PFOS Levels (Presented as Adjusted Fecundability Ratios)

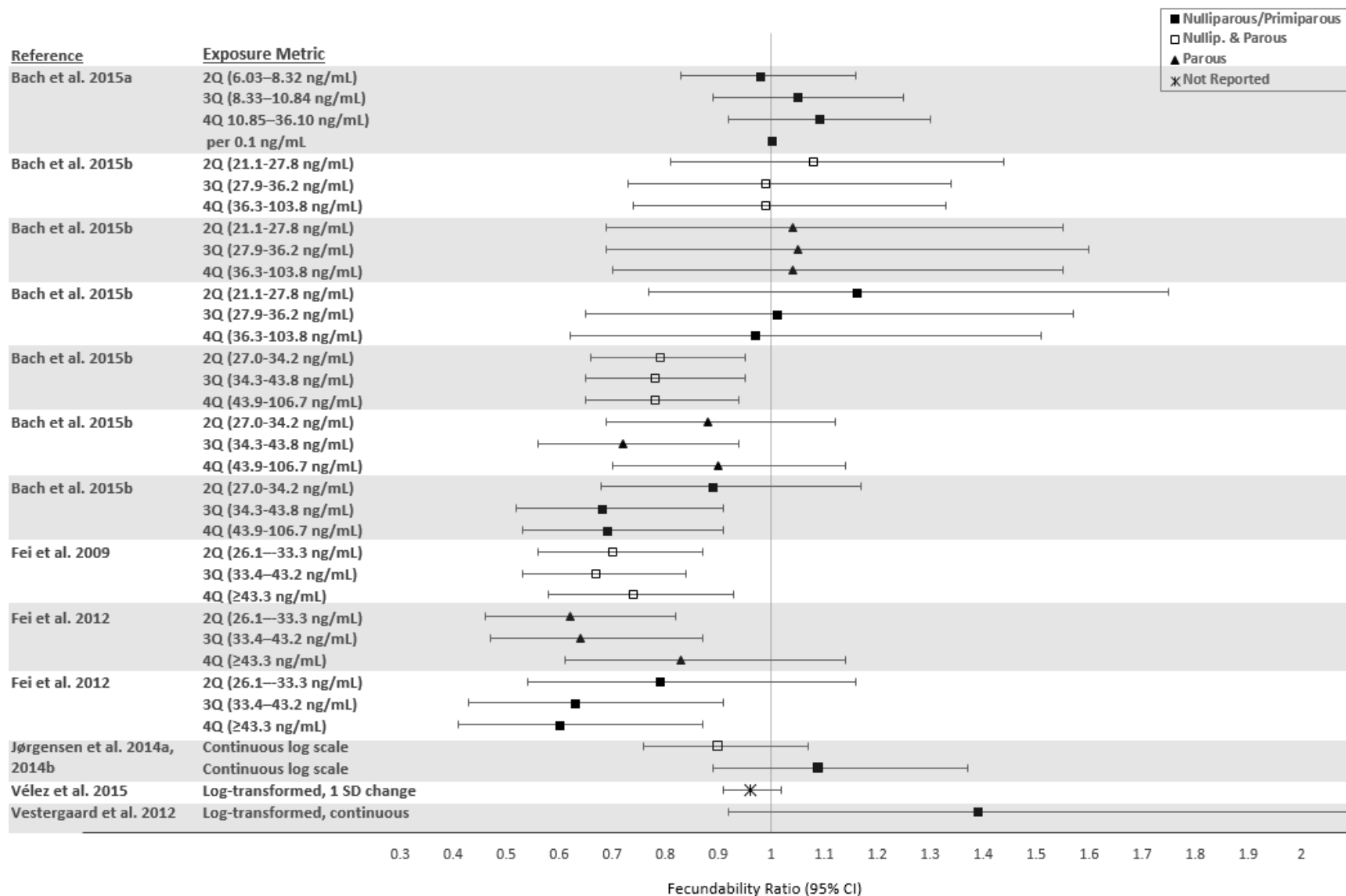

2. HEALTH EFFECTS

Figure 2-32. Infertility Relative to PFOS Levels (Presented as Adjusted Odds Ratios)

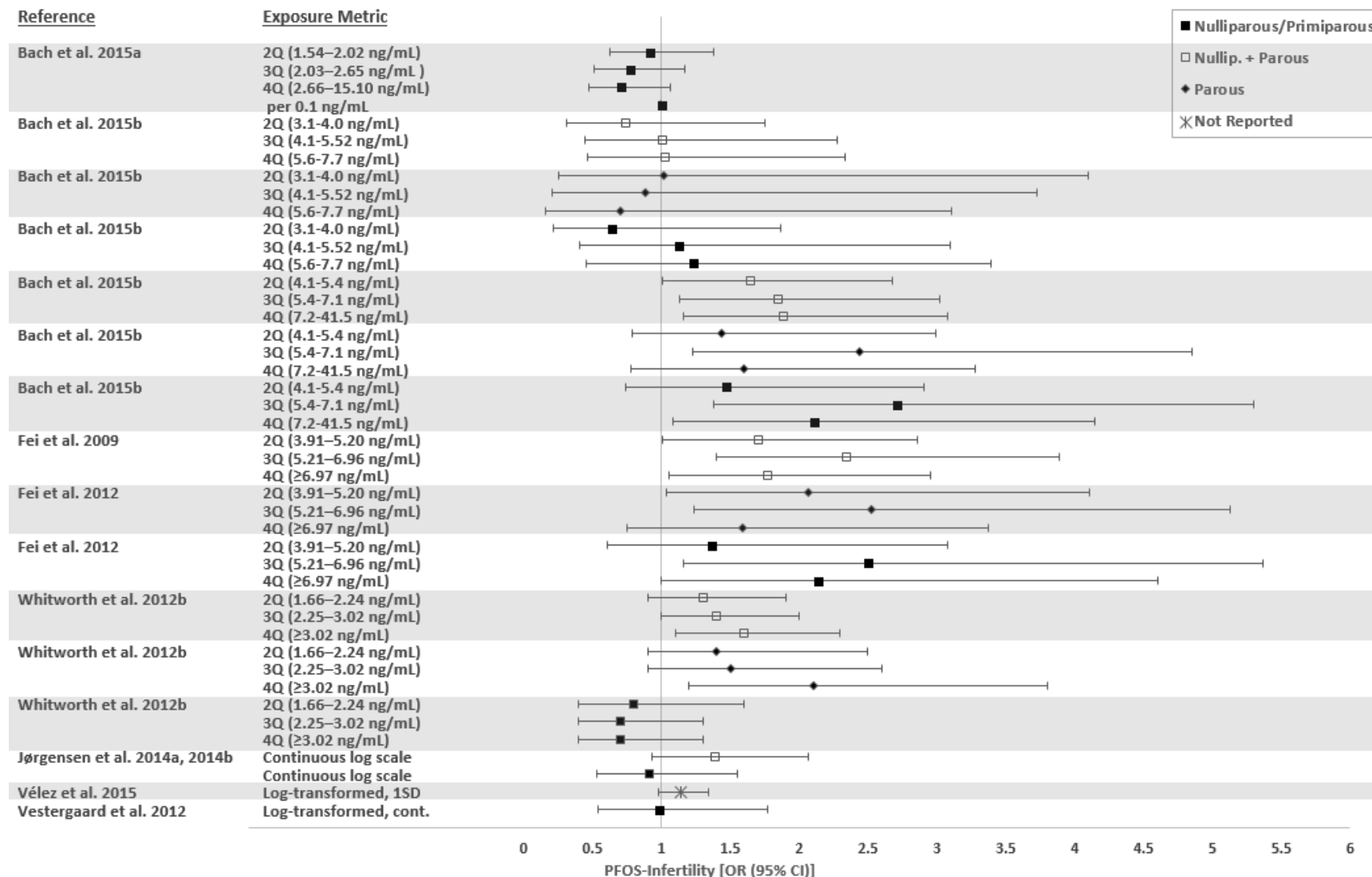

2. HEALTH EFFECTS

rats did not provide indications of reproductive toxicity. Exposure of male and female rats to up to 3.2 mg/kg/day PFOS by gavage before mating and continuing during gestation did not affect mating or fertility parameters of the parental or F1 generation (Luebker et al. 2005a, 2005b). Dietary exposure of rats to 1.3–1.8 mg/kg/day PFOS for 4 or 14 weeks did not induce gross or microscopic alterations in the sex organs of males or females (Seacat et al. 2003). A similar study in *Cynomolgus* monkeys administered up to 0.75 mg/kg/day PFOS administered via a capsule also reported no significant morphological alterations in the sex organs, but serum estradiol was significantly decreased in males on days 62, 91, and 182 of the study (Seacat et al. 2002). In addition, treatment with PFOS had no significant effect on cell proliferation in the testes. Serum estradiol also was lower than in controls in one male and one female monkey dosed with 2 mg/kg/day PFOS for 4 weeks, but little can be concluded from results from just two animals (Thomford 2002a). In a 2-year dietary study in rats, administration of up to 1.04 mg/kg/day PFOS did not induce gross or microscopic alterations in the reproductive organs (Butenhoff et al. 2012b; Thomford 2002b). Overall, the reproductive system does not seem to be a sensitive target of PFOS toxicity, although some changes in testosterone and estradiol levels have been observed.

PFHxS

Epidemiology Studies—Reproductive Hormone Levels. Two general population studies evaluated possible effects of PFHxS on reproductive hormone levels. In young men, no associations between serum PFHxS levels and testosterone, free androgen index, LH, estradiol, sex hormone binding globulin, or FSH levels were found (Joensen et al. 2013). Similarly, no alterations in follicular estrogen or luteal progesterone were observed in women (Barrett et al. 2015).

Epidemiology Studies—Effects on Sperm. With the exception of the finding of an inverse association between serum PFHxS levels and percent normal sperm (Toft et al. 2012), general population studies have not found associations between PFHxS and sperm parameters (Joensen et al. 2013; Toft et al. 2012); it is noted that the Joensen et al. (2013) study of young men did not find alterations in sperm morphology.

Epidemiology Studies—Effects on Menstrual Cycle Length, Menopause Onset, Endometriosis, and Breastfeeding Duration. Four general population studies have evaluated possible associations between serum PFHxS levels and female reproductive outcomes. Taylor et al. (2014) reported increases in the risk of earlier menopause in women with serum PFHxS levels in the 3rd tertile and the risk of hysterectomy in women with serum PFHxS levels in the 2nd and 3rd tertiles. Other studies did not find associations with

2. HEALTH EFFECTS

the risk and severity of endometriosis (Buck Louis et al. 2012) or polycystic ovary syndrome (Vagi et al. 2014). Romano et al. (2016) did not find associations between maternal PFHxS levels and the risk of breastfeeding ≤ 3 or 6 months.

Epidemiology Studies—Effects on Fertility. Four studies have evaluated possible effects on fertility associated with female serum PFHxS levels. Vélez et al. (2015) found increases in time to pregnancy (measured as a decreased fecundability OR) and risk of infertility, which were associated with serum PFHxS levels in pregnant women. Vestergaard et al. (2012) reported an increase in the fecundability OR, indicating a shorter time to pregnancy, when risk was calculated using continuous serum PFHxS; however, when the subjects were divided into two groups based on serum PFHxS levels above and below the median level, the fecundability ratio included unity in the above-median group (fecundability ratio 1.29, 95% CI 0.90–1.83), as compared to the below-median group. Studies by Bach et al. (2015a) and Jørgensen et al. (2014a) did not find alterations in time to pregnancy or the risk of infertility.

Laboratory Animal Studies. Exposure to 10 mg/kg/day PFHxS did not result in alterations in reproductive organ weights or histopathology in male rats exposed for a minimum of 42 days beginning 14 days prior to cohabitation and female rats sacrificed on lactation day 21 or GD 25 (rats that did not deliver a litter) (exposure began 14 days prior to cohabitation) (Butenhoff et al. 2009a; Hoberman and York 2003). Fertility was not affected by treatment with PFHxS and there were no significant effects on sperm parameters. Also, estrous cycling was not affected by dosing with PFHxS.

PFNA

Epidemiology Studies—Reproductive Hormone Levels. Reproductive hormone alterations associated with serum PFNA levels are limited to a finding for estradiol in young men (Joensen et al. 2013); no associations with other reproductive hormones were found in this study. In another study of adolescent and young adults, no associations between serum PFNA and sex hormone binding globulin, FSH, or testosterone were found in males or females (subjects were segregated by sex and age range) (Tsai et al. 2015). A third study did not find alterations in follicular estradiol or luteal progesterone levels in women (Barrett et al. 2015).

Epidemiology Studies—Effects on Sperm. Buck Louis et al. (2015) found associations between serum PFNA and increases in the percentage of normal sperm and a decrease in the percentage of sperm with

2. HEALTH EFFECTS

coiled tails. No associations were found for other sperm parameters (Buck Louis et al. 2015; Joensen et al. 2013; Toft et al. 2012).

Epidemiology Studies—Effects on Menstrual Cycle Length, Menopause Onset, Endometriosis, and Breastfeeding Duration.

Increases in the risk of earlier menopause and hysterectomy were found in women with serum PFNA levels in the 3rd and $\geq 2^{\text{nd}}$ serum PFNA tertiles (Taylor et al. 2014). The investigators examined the possibility that these effects may be due to reverse causation and found that serum PFNA levels increased post-menopause (Taylor et al. 2014). An increase in the risk of endometriosis was associated with serum PFNA levels in a general population study (Buck Louis et al. 2012); however, adjustment for parity resulted in OR CIs that included unity. Vagi et al. (2014) did not find an increased risk of polycystic syndrome that was associated with serum PFNA levels. No associations between maternal PFNA levels and the risk of breastfeeding ≤ 3 or 6 months were found in a general population study (Romano et al. 2016).

Epidemiology Studies—Effects on Fertility. Jørgensen et al. (2014a) found increases in time to pregnancy (measured as a decrease in fecundability ratio) and an increase in infertility risk in a study of pregnant women. In sensitivity analysis, the fecundability ratio for primiparous women was 0.99 and the 95% CI range included unity (0.88–1.22). Studies by Bach et al. (2015a) and Vestergaard et al. (2012) did not find associations between serum PFNA levels and fecundability ratio; Bach et al. (2015a) also did not find an increase in the risk of infertility.

Laboratory Animal Studies. Two acute-duration studies have evaluated the reproductive toxicity of PFNA in male rats (Feng et al. 2009, 2010). Gavage administration of 5 mg/kg/day for 14 days resulted in decreases in serum testosterone and increases in serum estradiol levels and atrophy of the seminiferous tubules (Feng et al. 2009). Electron microscopic examination of the testes revealed large vacuoles between the Sertoli cells and spermatogonia; these changes as well as increases in serum Mullerian inhibiting substance and decreases in serum inhibin B cells were suggestive of damage to the secretory function of the Sertoli cells (Feng et al. 2010).

PFDeA

Epidemiology Studies—Reproductive Hormone Levels. No associations were found between serum PFDeA levels and testosterone, free androgen index, LH, estradiol, sex hormone binding globulin, or FSH

2. HEALTH EFFECTS

levels in young men (Joensen et al. 2013). Similarly, no alterations in follicular estradiol or luteal progesterone levels were observed in women (Barrett et al. 2015).

Epidemiology Studies—Effects on Sperm. Two general population studies evaluated potential effects of PFDeA exposure on sperm parameters. Buck Louis et al. (2015) found associations between serum PFDeA levels and increases in sperm head length and decreases in the percentage of sperm with coiled tails. No alterations were found for sperm viability, count, volume, motility, or other morphological alterations (Buck Louis et al. 2015; Joensen et al. 2013).

Epidemiology Studies—Effects on Menstrual Cycle Length, Menopause Onset, and Endometriosis. Only one study examined alterations in female reproductive outcomes associated with serum PFDeA levels. In this study, no associations between serum PFDeA levels and the risk or severity of endometriosis were found (Buck Louis et al. 2012).

Epidemiology Studies—Effects on Fertility. Two studies have examined the potential for PFDeA to alter fertility. No alterations in time to pregnancy (measured as fecundability ratio) or risk of infertility were observed in pregnant women (Bach et al. 2015a). Another study (Vestergaard et al. 2012) also found no association between female serum PFDeA levels and time to pregnancy.

PFUA

Epidemiology Studies—Reproductive Hormone Levels. An inverse association between serum PFUA levels and FSH levels was observed in adolescent girls (Tsai et al. 2015). The study did not find alterations in sex hormone binding globulins or testosterone levels in adolescent and young adult males or females. Another study of women did not find alterations in follicular estradiol or luteal progesterone levels (Barrett et al. 2015).

Epidemiology Studies—Effects on Fertility. Only one study evaluated possible associations between maternal serum PFUA levels and fertility; no alterations in time to pregnancy (measured as a fecundability ratio) or infertility risk were observed in pregnant women (Bach et al. 2015a).

2. HEALTH EFFECTS

PFBuS

Laboratory Animal Studies. Administration of up to 900 mg/kg/day PFBuS to rats by gavage for 28 days did not cause any significant gross or microscopic alterations in primary or secondary sex organs from males or females (3M 2001). A 2-generation study in which rats were exposed to gavage doses of potassium PFBuS as high as 1,000 mg/kg/day did not result in alterations in fertility, sperm parameters, estrus cycling, or histological alterations in reproductive tissues (Lieder et al. 2009b).

PFBA

Laboratory Animal Studies. No significant gross or microscopic alterations were reported in primary and secondary reproductive organs from rats dosed with PFBA by gavage in doses of up to 184 mg/kg/day for 5 days, 150 mg/kg/day for 28 days, or 30 mg/kg/day for 90 days (3M 2007a; Butenhoff et al. 2012a; van Otterdijk 2007a, 2007b).

PFDoA

Laboratory Animal Studies. Treatment of male rats with 1, 5, or 10 mg/kg/day PFDoA by gavage for 14 days induced a dose-related decrease in testes weight, which achieved statistical significance at 10 mg/kg/day (Shi et al. 2007). Measurement of serum hormone levels showed a significant decrease in LH at 10 mg/kg/day and in testosterone at 5 and 10 mg/kg/day, no significant effect on FSH levels, and a significant decrease in serum estradiol only at 5 mg/kg/day. Alterations in the ultrastructure of the testes were seen in the 5 and 10 mg/kg/day groups and consisted of the presence of large clustered lipid droplets and enlarged mitochondria in Sertoli cells, large vacuoles, and expanded mitochondria in Leydig and spermatogenic cells. Morphological features of apoptosis were seen in cells in the 10 mg/kg/day group. Assessment of messenger ribonucleic acid (mRNA) expression of genes involved in cholesterol transport and steroidogenesis provided evidence of altered cholesterol transport and steroid hormone synthesis, but no effects were noted for LH receptor and aromatase mRNA expression. Considering that serum total cholesterol was unaffected at 5 mg/kg/day and increased at 10 mg/kg/day and that aromatase expression was unaffected, the decrease in testosterone synthesis probably resulted from decreased steroidogenesis gene expression.

2. HEALTH EFFECTS

PFOSA

Epidemiology Studies. One study examined reproductive hormone levels and did not find an association between serum PFOSA and follicular estradiol or luteal progesterone levels in women (Barrett et al. 2015). The only epidemiology study evaluating fertility did not find an increase in time to pregnancy, as measured as a fecundability ratio, or decrease in the likelihood of becoming pregnant within the first six menstrual cycles (Vestergaard et al. 2012).

Me-PFOSA-AcOH

Epidemiology Studies. In the only study identified that examined sperm parameters associated with Me-PFOSA-AcOH, increases in the percentage of sperm with neck/midpiece abnormalities and increases in the number of immature sperm were found (Buck Louis et al. 2015). No associations with sperm viability, count, or motility were found. One study examining fertility did not find associations between serum Me-PFOSA-AcOH levels in women and time to pregnancy (Vestergaard et al. 2012).

Et-PFOSA-AcOH

Epidemiology Studies. No associations between serum Et-PFOSA-AcOH levels in females and the time to pregnancy were observed in a study of nulliparous couples (Vestergaard et al. 2012).

2.17 DEVELOPMENTAL

Overview. A large number of epidemiology studies have examined the potential of developmental toxicity of perfluoroalkyls in the general population and in populations living in an area with high PFOA drinking water contamination. The discussion of these developmental outcomes is divided into four categories: pregnancy outcome, birth outcome, neurodevelopment, and sexual maturation. The epidemiology studies examining pregnancy outcome are summarized in Table 2-22; the pregnancy outcomes include miscarriage, stillbirth, preterm birth, and gestation age. Table 2-23 summarizes the epidemiology studies examining birth outcomes, which include birth weight, birth size, low birth weight, small for gestational age, birth defects, and sex ratio. Epidemiology studies examining neurodevelopmental endpoints, particularly risks for ADHD, are summarized in Table 2-24. Studies evaluating possible links between serum perfluoroalkyl levels and development of the reproductive system are summarized in Table 2-25. Further details on these studies are presented in the *Supporting*

2. HEALTH EFFECTS

Table 2-22. Summary of Pregnancy Outcomes in Humans^a

Reference and study population ^b	Serum perfluoroalkyl level	Outcome evaluated	Result ^c
PFOA			
Darrow et al. 2013 Community (C8) (n=1,330 women)	≥37.2 ng/mL (5 th PFOA quintile)	Preterm birth	OR 1.01 (0.55–1.86)
Darrow et al. 2014 Community (C8) (n=1,129 women)	>39.4 ng/mL (5 th PFOA quintile)	Miscarriage risk Parous subgroup Nulliparous subgroup	OR 1.00 (0.63–1.58), 5 th quintile OR 1.06 (0.57–1.97), 5 th quintile OR 0.81 (0.38–1.71), 5 th quintile
Savitz et al. 2012a Community (C8) (11,737 singleton infants)	63.1–934.3 ng/mL (4 th maternal PFOA quartile)	Miscarriage Stillbirth	OR 0.9 (0.7–1.0) OR 1.0 (0.5–1.8)
Savitz et al. 2012b Community (13,243 cases stillbirth, preterm birth, low birth weight or small for gestational age)	21.0–717.6 ng/mL (5 th maternal PFOA quintile)	Stillbirth Preterm birth (<37 weeks) Preterm birth (<32 weeks)	OR 0.8 (0.5–1.5) OR 1.0 (0.9–1.2) OR 1.0 (0.7–1.3)
Savitz et al. 2012b Community (4,547 infants)	83.3–921.3 ng/mL (5 th maternal PFOA quintile)	Preterm birth (<37 weeks) Preterm birth (<32 weeks)	OR 1.2 (0.9–1.6) OR 1.4 (0.5–3.6)
Stein et al. 2009 Community (C8) (n=1,845 pregnancies)	48.8 ng/mL (maternal mean PFOA)	Miscarriage Preterm birth	OR 0.9 (0.5–1.6), >90 th percentile OR 0.9 (0.6–1.5), >90 th percentile
Apelberg et al. 2007b General population (n=341 singleton births)	1.6 ng/mL (cord serum median PFOA)	Gestational age	NS (p>0.05)
Chen et al. 2012a General population (n=429 infants)	1.84 ng/mL (cord blood geometric mean PFOA)	Gestational age Preterm birth	NS (p>0.05) OR 0.64 (0.40–1.02)
Hamm et al. 2010 General population (n=252 pregnant women)	>2.1–18 ng/mL (maternal 3 rd PFOA tertile)	Preterm birth	RR 1.31 (0.38–4.45), 3 rd tertile

2. HEALTH EFFECTS

Table 2-22. Summary of Pregnancy Outcomes in Humans^a

Reference and study population ^b	Serum perfluoroalkyl level	Outcome evaluated	Result ^c
Jensen et al. 2015 General population (n=56 cases and 336 controls)	1.58 ng/mL (maternal median PFOA)	Miscarriage before gestation week 12	OR 0.64 (0.36–1.18)
Whitworth et al. 2012a General population (n=901 infants)	≥3.04 ng/mL (maternal 4 th PFOA quartile)	Preterm birth	OR 0.1 (0.03–0.6)*, 4th quartile
PFOS			
Darrow et al. 2013 Community (C8) (n=1,330 women)	15.6 ng/mL (mean PFOS)	Preterm birth	OR 1.07 (0.58–1.95)
Darrow et al. 2014 Community (C8) (n=1,129 women)	>23.3 ng/mL (5 th PFOS quintile)	Miscarriage risk Parous subgroup Nulliparous subgroup	OR 1.41 (0.88–2.26), 5 th quintile OR 1.12 (0.58–2.17), 5 th quintile OR 2.02 (0.83–4.93), 5 th quintile
Stein et al. 2009 Community (C8) (n=5,262 infants)	23.2–83.4 ng/mL (>90 th PFOS percentile)	Miscarriage Preterm birth	OR 0.9 (0.7–1.3), >90 th percentile OR 1.4 (1.1–1.7)*, >90th percentile
Chen et al. 2012a General population (n=429 infants)	5.94 ng/mL (cord blood geometric mean PFOS)	Preterm birth	OR 2.45 (1.47–4.08)*
Fei et al. 2007, 2008a General population (n=1,400 pregnant women)	35.3 ng/mL (maternal median PFOS)	Gestation length Preterm birth	NS (p>0.01) OR 1.43 (0.50–4.11), 4 th quartile
Hamm et al. 2010 General population (n=252 pregnant women)	>10–35 ng/mL (maternal 3 rd tertile PFOS)	Preterm birth	RR 1.11 (0.36–3.38), 3 rd tertile
Jensen et al. 2015 General population (n=56 cases and 336 controls)	8.10 ng/mL (maternal median PFOS)	Miscarriage before gestation week 12	OR 1.16 (0.59–1.29)
Whitworth et al. 2012a General population (n=901 infants)	13.0 and ≥16.59 ng/mL (maternal median and 4 th quartile PFOS)	Preterm birth	OR 0.3 (0.1–1.0, p=0.03)*, 4th quartile

2. HEALTH EFFECTS

Table 2-22. Summary of Pregnancy Outcomes in Humans^a

Reference and study population ^b	Serum perfluoroalkyl level	Outcome evaluated	Result ^c
PFHxS			
Hamm et al. 2010	>1.4–43 ng/mL (maternal 3 rd tertile PFHxS)	Preterm birth	RR 0.31 (0.11–0.90)*, 3rd tertile
General population (n=252 pregnant women)			
Jensen et al. 2015	0.298 ng/mL (maternal median PFHxS)	Miscarriage before gestation week 12	OR 1.53 (0.99–2.38)
General population (n=56 cases and 336 controls)			
PFNA			
Chen et al. 2012a	2.36 ng/mL (cord blood geometric mean PFNA)	Preterm birth	OR 0.88 (0.71–1.11)
General population (n=429 infants)			
Jensen et al. 2015	0.72 ng/mL (maternal median PFNA)	Miscarriage before gestation week 12	OR 16.46 (7.39–36.62)*
General population (n=56 cases and 336 controls)			
PFDeA			
Jensen et al. 2015	0.27 ng/mL (maternal median PFDeA)	Miscarriage before gestation week 12	OR 2.30 (1.18–4.47)*
General population (n=56 cases and 336 controls)			
PFUA			
Chen et al. 2012a	10.26 ng/mL (cord blood geometric mean PFUA)	Preterm birth	OR 0.87 (0.64–1.16)
General population (n=429 infants)			

^aSee the *Supporting Document for Epidemiological Studies for Perfluoroalkyls*, Table 13 for more detailed descriptions of studies.

^bParticipants in occupational exposure may have also lived near the site and received residential exposure; community exposure studies involved subjects living near PFOA facilities with known exposure to high levels of PFOA.

^cAsterisk indicates association with perfluoroalkyl compound; unless otherwise specified, values in parenthesis are 95% confidence intervals.

OR = odds ratio; NS = not significant; PFDeA = perfluorodecanoic acid; PFHxS = perfluorohexane sulfonic acid; PFNA = perfluorononanoic acid; PFOA = perfluorooctanoic acid; PFOS = perfluorooctane sulfonic acid; PFUA = perfluoroundecanoic acid; RR= risk ratio

2. HEALTH EFFECTS

Table 2-23. Summary of Birth Outcomes in Humans^a

Reference and study population ^b	Serum perfluoroalkyl level	Outcome evaluated	Result ^c
PFOA			
Darrow et al. 2013	≥37.2 ng/mL (5 th PFOA quintile)	Birth weight	NS (p=0.70 for trend)
Community (C8) (n=1,330 women)		Low birth weight	OR 0.92 (0.44–1.95)
Nolan et al. 2009	NR	Birth weight	NS (p>0.05)
Community (n=1,555 singleton infants)		Low birth weight	OR 0.37 (0.16–0.86)*
Nolan et al. 2010	NR	Congenital anomalies	OR 1.1 (0.34–3.3)
Community (n=1,548 singleton infants)			
Savitz et al. 2012a	63.1–934.3 ng/mL (4 th maternal PFOA quartile)	Low birth weight	OR 0.37 (0.16–0.86)*
Community (C8) (11,737 singleton infants)		Birth defect	OR 1.0 (0.8–1.3)
Savitz et al. 2012b	7.7 ng/mL (estimated maternal median PFOA)	Birth weight	β -14.80 (-42.28–13.68), per 100 ng/mL increase in PFOA
Community (13,243 cases stillbirth, preterm birth, low birth weight or small for gestational age)		Low birth weight	OR 1.0 (0.86–1.15), per 100 ng/mL increase in PFOA
		Small for gestational age	OR 0.86 (0.67–1.11), per 100 ng/mL increase in PFOA
Savitz et al. 2012b	13.4 ng/mL (estimated maternal median PFOA)	Low birth weight	OR 1.07 (0.96–1.18), per 100 ng/mL increase in PFOA
Community (4,547 infants)		Small for gestational age	OR 1.08 (1.01–1.16)*, per 100 ng/mL increase in PFOA OR 0.8 (0.6–1.2), for serum PFOA levels ≥80 th percentile
		Birth weight	OR -12.76 (-26.08–0.57), per 100 ng/mL increase in PFOA
Stein et al. 2009	50.0–<120.6 and 120.6–894.4 ng/mL (3 rd and 4 th maternal PFOA quartile)	Low birth weight	OR 0.8 (0.3–1.9), 4 th quartile
Community (C8) (n=1,845 pregnancies)		Birth defects	OR 1.7 (0.8–3.6), 4 th quartile

2. HEALTH EFFECTS

Table 2-23. Summary of Birth Outcomes in Humans^a

Reference and study population ^b	Serum perfluoroalkyl level	Outcome evaluated	Result ^c
Stein et al. 2014c Community (C8) (n=10,262 infants)	61.3 ng/mL (estimated <i>in utero</i> mean PFOA)	Brain defects	OR 2.6 (1.3–5.1), interquartile range
		Gastrointestinal defects	OR 0.7 (0.3–1.4), interquartile range
		Kidney defects	OR 0.7 (0.3–1.8), interquartile range
		Craniofacial defects	OR 0.6 (0.3–1.3), interquartile range
		Eye defects	OR 1.1 (0.6–2.1), interquartile range
		Limb defects	OR 1.2 (0.7–2.0), interquartile range
		Genitourinary defects	OR 1.0 (0.6–1.7), interquartile range
		Heart defects	OR 1.2 (0.8–1.7), interquartile range
Apelberg et al. 2007b General population (n=341 singleton births)	1.6 ng/mL (cord serum median PFOA)	Birth weight	NS (p>0.05)
		Birth length	NS (p>0.05)
		Head circumference	Inverse association (p>0.05)*
		Ponderal index	Inverse association (p>0.05)*
Ashley-Martin et al. 2016 General population (n=1,723 pregnant women)	1.70 and 0.39 ng/mL (maternal and cord median PFOA)	Gestational weight gain	NS (p>0.1), serum PFOA OR 1.04 (1.02–1.06)*, cord PFOA
Bach et al. 2016 General population (n=1,507 nulliparous women)	2.0 ng/mL (median PFOA)	Birth weight	NS, investigators noted no consistent alterations across PFOA quartiles
		Birth length	NS, investigators noted no consistent alterations across PFOA quartiles
		Head circumference	NS, investigators noted no consistent alterations across PFOA quartiles
Bae et al. 2015 General population (n=233 couples)	5.01 and 4.05 ng/mL and 5.00 and 2.54 ng/mL (geometric mean PFOA in male and female nulliparous parents and male and female parous parents, respectively)	Male birth	OR 0.93 (0.68–1.26), maternal PFOA OR 0.94 (0.72–1.23), paternal PFOA

2. HEALTH EFFECTS

Table 2-23. Summary of Birth Outcomes in Humans^a

Reference and study population ^b	Serum perfluoroalkyl level	Outcome evaluated	Result ^c
Chen et al. 2012a General population (n=429 infants)	1.84 ng/mL (cord blood geometric mean PFOA)	Birth weight	NS (p>0.05)
		Birth length	NS (p>0.05)
		Head circumference	NS (p>0.05)
		Ponderal index	NS (p>0.05)
		Small for gestational age	OR 1.24 (0.75–2.05)
		Low birth weight	OR 0.53 (0.18–1.55)
Fei et al. 2007, 2008a General population (n=1,400 pregnant women)	5.6 ng/mL (maternal median PFOA)	Birth weight	β -10.63 (-20.79 to -0.47)*
		Birth length	β -0.069 (-0.113 to -0.024)*
		Abdominal circumference	β -0.059 (-0.106 to -0.012)*
		Head circumference	β-0.030 (-0.064–0.004)
		Low birth weight	OR 2.44 (0.27–22.25), 4 th quartile
		Small for gestation age	OR 0.97 (0.55–1.70), 4 th quartile
Govarts et al. 2016 General population (n=202 infants)	1.52 ng/mL (cord blood geometric mean PFOA)	Birth weight	NS (p=0.473)
Hamm et al. 2010 General population (n=252 pregnant women)	>2.1–18 ng/mL (maternal 3 rd tertile PFOA)	Birth weight	Change in weight 14.80 (-107.29–136.89), 3 rd tertile
		Small for gestational age	RR 0.99 (0.25–3.92), 3 rd tertile
Kim et al. 2011 General population (n=44 pregnant women)	1.46 ng/mL (maternal median PFOA)	Birth weight	NS (p>0.05)
		Cord TSH	Association (p<0.05)*
		Cord T3	NS (p>0.05)
		Cord T4	NS (p>0.05)
Kim et al. 2016a General population (n=27 infants with congenital hypothyroidism; n=13 controls)	5.398 and 2.12 ng/mL (mean PFOA in cases and controls)	Thyroid stimulating immunoglobulin levels	Inverse association (p<0.05)*
		TSH	NS (p>0.05)
		T3	NS (p>0.05)
		T4	NS (p>0.05)

2. HEALTH EFFECTS

Table 2-23. Summary of Birth Outcomes in Humans^a

Reference and study population ^b	Serum perfluoroalkyl level	Outcome evaluated	Result ^c
Lee et al. 2013 General population (n=59 pregnant women)	2.73 ng/mL (maternal mean PFOA)	Birth weight	OR 0.54 (0.17–3.03)
		Birth length	OR 0.44 (0.12–1.58)
		Ponderal index	OR 0.56 (0.16–2.01)
		Head circumference	OR 0.82 (0.24–13.65)
Lee et al. 2016 General population (n=85 infants)	1.11 ng/mL (cord blood mean PFOA)	Birth weight	NS (p>0.05)
Lenters et al. 2016a, 2016b General population (n=513 infants in Greenland subcohort, n=557 infants in Ukraine subcohort, and n=180 infants in Poland subcohort)	1.84, 0.96, and 2.51 ng/mL (maternal median PFOA for Greenland, Ukraine, and Poland subcohorts)	Birth weight	β -63.77 (-122.83 to -4.71, p=0.035)*. 2 SD increase in ln-transformed PFOA
Maisonet et al. 2012 General population (n=447 girls)	3.7 ng/mL (maternal median PFOA)	Birth weight	Inverse association (p=0.0120 for trend)*
		Birth length	NS (p=0.0978)
		Ponderal index	NS (p=0.5920)
		Body weight at 20 months	NS (p=0.4147)
Monroy et al. 2008 General population (n=101 pregnant women)	1.81 and 1.58 ng/mL (maternal and cord median PFOA)	Birth weight	NS (p>0.05), maternal serum and cord blood PFOA
Robledo et al. 2015a, 2015b General population (n=234 couples)	3.16 and 5.00 ng/mL (maternal and paternal geometric mean PFOA)	Birth weight	NS (p>0.05), maternal or paternal
		Birth length	NS (p>0.05), maternal or paternal
		Head circumference	NS (p>0.05), maternal or paternal
		Ponderal index	NS (p>0.05), maternal or paternal
Wang et al. 2016 General population (n=117 boys and 106 girls examined at 2, 5, 8, and 11 years of age)	2.37 and 2.34 ng/mL (median maternal PFOA for boys and girls)	Birth weight	NS (p>0.05)
		Birth length	NS (p>0.05)
		Head circumference	NS (p>0.05)
		Small for gestational age	NS (p>0.05)

2. HEALTH EFFECTS

Table 2-23. Summary of Birth Outcomes in Humans^a

Reference and study population ^b	Serum perfluoroalkyl level	Outcome evaluated	Result ^c
Washino et al. 2009 General population (n=428 infants)	1.3 ng/mL (maternal median PFOA)	Birth weight	NS (p=0.207)
		Birth length	NS (p=0.631)
		Chest circumference	NS (p=0.460)
		Head circumference	NS (p=0.823)
Whitworth et al. 2012a General population (n=901 infants)	2.2 and ≥3.04 ng/mL (maternal median and 4 th quartile PFOA)	Birth weight	NS (p=0.12)
		Small for gestational age	NS (p=0.92)
		Large for gestational age	NS (p=0.33)
PFOS			
Grice et al. 2007 Occupational (n=263 females)	1,300–1,970 ng/mL (range of PFOS)	Birth weight	NS (p=0.15)
Darrow et al. 2013 Community (C8) (n=1,330 women)	15.6 ng/mL (mean PFOS)	Birth weight	NS (p=0.045 for trend), whole cohort Association (p=0.006), women (n=783) who conceived after blood sample collection
		Low birth weight	OR 1.33 (0.60–2.96)
Stein et al. 2009 Community (C8) (n=5,262 infants)	17.7–<23.2 and 23.2–83.4 ng/mL (75 th –90 th and >90 th PFOS percentile)	Low birth weight	OR 1.6 (1.1–2.3)*, 75th–90th percentile
		Birth defects	OR 1.3 (0.8–2.1)
Apelberg et al. 2007b General population (n=341 singleton births)	5 ng/mL (PFOS cord serum median)	Gestational age	NS (p>0.05)
		Birth weight	NS (p>0.05)
		Birth length	NS (p>0.05)
		Head circumference	Inverse association (p>0.05)*
		Ponderal index	Inverse association (p>0.05)*
Ashley-Martin et al. 2016 General population (1,723 pregnant women)	4.60 and 0.15 ng/mL (maternal and cord PFOS median)	Gestational weight gain	Association (p<0.1), serum PFOS in underweight/normal weight subjects OR 1.03 (1.00–1.05)*, cord PFOS

2. HEALTH EFFECTS

Table 2-23. Summary of Birth Outcomes in Humans^a

Reference and study population ^b	Serum perfluoroalkyl level	Outcome evaluated	Result ^c
Bach et al. 2016 General population (n=1,507 nulliparous women)	8.3 ng/mL (PFOS median)	Birth weight	Inverse association reported by investigators
		Birth length	NS, investigators noted no consistent alterations across PFOS quartiles
		Head circumference	NS, investigators noted no consistent alterations across PFOS quartiles
Bae et al. 2015 General population (233 couples)	21.7 and 14.5 ng/mL and 21.5 and 10.8 ng/mL (geometric mean PFOS in male and female nulliparous parents and male and female parous parents, respectively)	Male birth	OR 1.16 (0.88–1.53), maternal PFOS OR 1.01 (0.78–1.33), paternal PFOS
Chen et al. 2012a General population (n=429 infants)	5.94 ng/mL (cord blood geometric mean PFOS)	Gestational age	Inverse association (p<0.001)*
		Birth weight	β -110.2 g (-176.0 to -44.5, p<0.001)*, per ln PFOS
		Birth length	NS (p>0.05)
		Head circumference	β -0.25 cm (-0.46–0.05 cm, p<0.05)*, per ln PFOS
		Ponderal index	NS (p>0.05)
		Small for gestational age	OR 2.27 (1.25–4.15)*
		Low birth weight	OR 2.61 (0.185–8.03)
de Cock et al. 2014 General population (n=89 infants)	1.611 ng/mL (cord blood mean PFOS)	Weight	NS (p=0.802)
		Height	NS (p=0.975)
		BMI	NS (p=0.586)
		Head circumference	NS (p=0.649)
Fei et al. 2007, 2008a General population (n=1,400 pregnant women)	35.3 ng/mL (maternal median PFOS)	Birth weight	β -0.46 (-2.34–1.41)
		Birth length	β -0.002 (-0.011–0.006)
		Abdominal circumference	β -0.003 (-0.012–0.005)
		Head circumference	β 0.000 (-0.006–0.007)
		Gestation length	NS (p>0.01)

2. HEALTH EFFECTS

Table 2-23. Summary of Birth Outcomes in Humans^a

Reference and study population ^b	Serum perfluoroalkyl level	Outcome evaluated	Result ^c
		Low birth weight	OR 4.82 (0.56–41.16), 4 th quartile
		Small for gestation age	OR 0.98 (0.58–1.65), 4 th quartile
Govarts et al. 2016	2.63 ng/mL (cord blood geometric mean PFOS)	Birth weight	NS (p=0.798)
General population (n=202 infants)			
Hamm et al. 2010	>10–35 ng/mL (maternal 3 rd tertile PFOS)	Birth weight	Change in weight 71.25 (54.97–197.48), 3 rd tertile
General population (n=252 pregnant women)			
		Small for gestational age	RR 0.26 (0.10–0.70)*, 3rd tertile
Kim et al. 2011	2.93 ng/mL (maternal median PFOS)	Birth weight	NS (p>0.05)
General population (n=44 pregnant women)			
		Cord TSH	NS (p>0.05)
		Cord T3	Inverse association (p<0.05)*
		Cord T4	NS (p>0.05)
Kim et al. 2016a	5.326 and 4.05 ng/mL (mean PFOS in cases and controls)	Thyroid stimulating immunoglobulin levels	NS (p>0.05)
General population (n=27 infants with congenital hypothyroidism; N=13 controls)			
		TSH	NS (p>0.05)
		T3	NS (p>0.05)
		T4	NS (p>0.05)
Lee et al. 2013	10.77 ng/mL (maternal mean PFOS)	Birth weight	OR 0.98 (0.32–3.03)
General population (n=59 pregnant women)			
		Birth length	OR 0.97 (0.29–3.27)
		Ponderal index	OR 0.22 (0.05–0.90)*
		Head circumference	OR 1.34 (0.20–8.90)
Lee et al. 2016	0.87 ng/mL (cord blood mean PFOS)	Birth weight	NS (p>0.05)
General population (n=85 infants)			
Lenters et al. 2016a, 2016b	20.09, 5.04, and 7.81 ng/mL (maternal median PFOS for Greenland, Ukraine, and Poland subcohorts)	Birth weight	NS (p=0.109)
General population (n=513 infants in Greenland subcohort, n=557 infants in Ukraine subcohort, and n=180 infants in Poland subcohort)			

2. HEALTH EFFECTS

Table 2-23. Summary of Birth Outcomes in Humans^a

Reference and study population ^b	Serum perfluoroalkyl level	Outcome evaluated	Result ^c
Liew et al. 2014 General population (n=156 children diagnosed with congenital cerebral palsy (cases) and 550 controls)	28.90 and 27.50 ng/mL (maternal median PFOS in boy and girl cases) 27.60 and 26.20 ng/mL (maternal median PFOS in boy and girl controls)	Congenital cerebral palsy	RR 1.7 (1.0–2.8)* RR 0.7 (0.4–1.4)
		Boys Girls	
Maisonet et al. 2012 General population (n=447 girls)	19.6 ng/mL (maternal median PFOS)	Birth weight	β -140.01 g (-238.14 to -41.89 g, p=0.0053 for trend)*, 3rd tertile
		Birth length	β -0.63 cm (-1.11 to -0.15 cm, p=0.103 for trend)* 3rd tertile
		Ponderal index	NS (p=0.1120)
Monroy et al. 2008 General population (n=101 pregnant women)	14.54 mg/mL and 6.08 ng/mL (maternal and cord median PFOS)	Birth weight	NS (p>0.05), maternal serum and cord blood PFOA
Robledo et al. 2015a, 2015b General population (n=234 couples)	12.44 and 21.6 ng/mL (maternal and paternal geometric mean PFOS)	Birth weight	NS (p>0.05), maternal or paternal
		Birth length	NS (p>0.05), maternal or paternal
		Head circumference	NS (p>0.05), maternal or paternal
		Ponderal index	NS (p>0.05), maternal or paternal
Washino et al. 2009 General population (n=428 infants)	5.2 ng/mL (maternal median PFOS)	Birth weight	β -148.8 g (-297.0 to -0.5 g, p=0.049)*, per log PFOS unit NS (p=0.917)
		Males	
		Females	β -269.4 g (-465.7 to -73.0 g, p=0.007)*, per log PFOS unit
		Birth length	NS (p=0.167)
		Chest circumference	NS (p=0.718)
		Head circumference	NS (p=0.488)
Whitworth et al. 2012a General population (n=901 infants)	13.0 and \geq 16.59 ng/mL (maternal median and 4 th quartile PFOS)	Birth weight	NS (p=0.10)
		Small for gestational age	NS (p=0.51)
		Large for gestational age	NS (p=0.33)

2. HEALTH EFFECTS

Table 2-23. Summary of Birth Outcomes in Humans^a

Reference and study population ^b	Serum perfluoroalkyl level	Outcome evaluated	Result ^c
PFHxS			
Ashley-Martin et al. 2016 General population (n=1,723 pregnant women)	1.00 and 0.10 ng/mL (maternal and cord PFHxS median)	Gestational weight gain	NS (p>0.1), serum PFHxS OR 1.01 (10.99–1.03), cord PFHxS
Bach et al. 2016 General population (n=1,507 nulliparous women)	0.5 ng/mL (maternal PFHxS median)	Birth weight	Inverse association reported by investigators
		Birth length	NS, investigators noted no consistent alterations across PFHxS quartiles
		Head circumference	NS, investigators noted no consistent alterations across PFHxS quartiles
Hamm et al. 2010 General population (n=252 pregnant women)	>1.4–43 ng/mL (maternal 3 rd tertile PFHxS)	Birth weight	Change in weight (25.99, 95% CI -95.25–147.23), 3 rd tertile
		Small for gestational age	RR 2.35 (0.63–8.72), 3 rd tertile
Kim et al. 2011 General population (n=44 pregnant women)	0.55 ng/mL (maternal median PFHxS)	Birth weight	NS (p>0.05)
		Cord TSH	NS (p>0.05)
		Cord T3	NS (p>0.05)
		Cord T4	NS (p>0.05)
Kim et al. 2016a General population (n=27 infants with congenital hypothyroidism; n=13 controls)	1.228 and 1.17 ng/mL (mean PFHxS in cases and controls)	Thyroid stimulating immunoglobulin levels	Association (p<0.05)*
		TSH	NS (p>0.05)
		T3	NS (p>0.05)
		T4	NS (p>0.05)
Lee et al. 2013 General population (n=59 pregnant women)	1.35 ng/mL (maternal mean PFHxS)	Birth weight	OR 0.57 (0.19–1.75)
		Birth length	OR 0.44 (0.12–1.58)
		Ponderal index	OR 0.64 (0.19–2.23)
		Head circumference	OR 0.90 (0.13–6.13)
Lee et al. 2016 General population (n=85 infants)	0.60 ng/mL (cord blood mean PFHxS)	Birth weight	NS (p>0.05)

2. HEALTH EFFECTS

Table 2-23. Summary of Birth Outcomes in Humans^a

Reference and study population ^b	Serum perfluoroalkyl level	Outcome evaluated	Result ^c
Lenters et al. 2016a, 2016b General population (n=513 infants in Greenland subcohort, n=557 infants in Ukraine subcohort, and n=180 infants in Poland subcohort)	2.05, 1.56, and 2.28 ng/mL (maternal median PFHxS for Greenland, Ukraine, and Poland subcohorts)	Birth weight	NS (p=0.801)
Liew et al. 2014 General population (n=156 children diagnosed with congenital cerebral palsy (cases) and 550 controls)	0.96 and 0.90 ng/mL (maternal median PFHxS in boy and girl cases) 0.92 and 0.92 ng/mL (maternal median PFHxS in boy and girl controls)	Congenital cerebral palsy Boys Girls	RR 1.2 (0.9–1.7) RR 1.1 (0.6–1.9)
Maisonet et al. 2012 General population (n=447 girls)	1.6 ng/mL (maternal median PFHxS)	Birth weight Birth length Ponderal index	Inverse association (p=0.0314 for trend)* Inverse association (p=0.0008 for trend)* NS (p=0.6802 for trend)
Monroy et al. 2008 General population (n=101 pregnant women)	1.62 mg/mL (maternal median PFHxS)	Birth weight	NS (p>0.05)
PFNA			
Bach et al. 2016 General population (n=1,507 nulliparous women)	0.8 ng/mL (PFNA median)	Birth weight Birth length Head circumference	NS, investigators noted no consistent alterations across PFNA quartiles NS, investigators noted no consistent alterations across PFNA quartiles NS, investigators noted no consistent alterations across PFNA quartiles
Bae et al. 2015 General population (233 couples)	1.60 and 1.37 ng/mL and 1.55 and 1.09 ng/mL (geometric mean PFNA in male and female nulliparous parents and male and female parous parents, respectively)	Male birth	OR 0.94 (0.70–1.26), maternal PFNA OR 0.94 (0.71–1.24), paternal PFNA

2. HEALTH EFFECTS

Table 2-23. Summary of Birth Outcomes in Humans^a

Reference and study population ^b	Serum perfluoroalkyl level	Outcome evaluated	Result ^c
Chen et al. 2012a General population (n=429 infants)	2.36 ng/mL (cord blood geometric mean PFNA)	Gestational age	NS (p>0.05)
		Birth weight	NS (p>0.05)
		Birth length	Association (p<0.01)*
		Head circumference	NS (p>0.05)
		Ponderal index	Inverse association (p<0.05)
		Small for gestational age	OR 0.97 (0.74–1.26)
		Low birth weight	OR 0.76 (0.47–1.23)
Kim et al. 2016a General population (n=27 infants with congenital hypothyroidism; n=13 controls)	1.931 and 0.633 ng/mL (mean PFNA in cases and controls)	Thyroid stimulating immunoglobulin levels	NS (p>0.05)
		TSH	NS (p>0.05)
		T3	NS (p>0.05)
		T4	NS (p>0.05)
Lee et al. 2016 General population (n=85 infants)	0.36 ng/mL (cord blood mean PFNA)	Birth weight	NS (p>0.05)
Lenters et al. 2016a, 2016b General population (n=513 infants in Greenland subcohort, n=557 infants in Ukraine subcohort, and n=180 infants in Poland subcohort)	0.69, 0.61, and 0.56 ng/mL (maternal median PFNA for Greenland, Ukraine, and Poland subcohorts)	Birth weight	NS (p=0.065)
Liew et al. 2014 General population (n=156 children diagnosed with congenital cerebral palsy (cases) and 550 controls)	0.46 and 0.39 ng/mL (maternal median PFNA in boy and girl cases) 0.44 and 0.41 ng/mL (maternal median PFNA in boy and girl controls)	Congenital cerebral palsy	
		Boys Girls	RR 1.2 (0.6–2.5) RR 0.6 (0.3–1.2)
Monroy et al. 2008 General population (n=101 pregnant women)	0.69 mg/mL (maternal median PFNA)	Birth weight	NS (p>0.05)

2. HEALTH EFFECTS

Table 2-23. Summary of Birth Outcomes in Humans^a

Reference and study population ^b	Serum perfluoroalkyl level	Outcome evaluated	Result ^c
Robledo et al. 2015a, 2015b General population (n=234 couples)	1.211 and 1.566 ng/mL (maternal and paternal geometric mean PFNA)	Birth weight	NS (p>0.05), maternal or paternal
		Birth length	NS (p>0.05), maternal or paternal
		Head circumference	NS (p>0.05), maternal or paternal
		Ponderal index	NS (p>0.05), maternal or paternal
Wang et al. 2016 General population (n=117 boys and 106 girls examined at 2, 5, 8, and 11 years of age)	1.55 and 1.58 ng/mL (median maternal PFNA for boys and girls)	Birth weight	Inverse association (p>0.05)*, girls only
		Birth length	NS (p>0.05)
		Head circumference	NS (p>0.05)
		Small for gestational age	NS (p>0.05)
		Growth during childhood	NS (p>0.05)
PFDeA			
Bach et al. 2016 General population (n=1,507 nulliparous women)	0.3 ng/mL (PFDeA median)	Birth weight	NS, investigators noted no consistent alterations across PFDeA quartiles
		Birth length	NS, investigators noted no consistent alterations across PFDe quartiles
		Head circumference	NS, investigators noted no consistent alterations across PFDeA quartiles
Bae et al. 2015 General population (233 couples)	0.46 and 0.38 ng/mL and 0.49 and 0.46 ng/mL (geometric mean PFDeA in male and female nulliparous parents and male and female parous parents, respectively)	Male birth	OR 1.07 (0.81–1.42), maternal PFDeA OR 1.02 (0.78–1.34), paternal PFDeA
Kim et al. 2016a General population (n=27 infants with congenital hypothyroidism; n=13 controls)	0.523 and 0.298 ng/mL (mean PFDeA in cases and controls)	Thyroid stimulating immunoglobulin levels	NS (p>0.05)
		TSH	NS (p>0.05)
		T3	NS (p>0.05)
		T4	NS (p>0.05)
Lee et al. 2016 General population (n=85 infants)	0.14 ng/mL (cord blood mean PFDeA)	Birth weight	NS (p>0.05)

2. HEALTH EFFECTS

Table 2-23. Summary of Birth Outcomes in Humans^a

Reference and study population ^b	Serum perfluoroalkyl level	Outcome evaluated	Result ^c
Lenters et al. 2016a, 2016b General population (n=513 infants in Greenland subcohort, n=557 infants in Ukraine subcohort, and n=180 infants in Poland subcohort)	0.40, 0.16, and 0.22 ng/mL (maternal median PFDeA for Greenland, Ukraine, and Poland subcohorts)	Birth weight	NS (p=0.158)
Liew et al. 2014 General population (n=156 children diagnosed with congenital cerebral palsy (cases) and 550 controls)	0.18 and 0.16 ng/mL (maternal median PFDeA in boy and girl cases) 0.17 and 0.16 ng/mL (maternal median PFDeA in boy and girl controls)	Congenital cerebral palsy Boys Girls	RR 1.1 (0.7–1.7) RR 0.6 (0.3–1.1)
Robledo et al. 2015a, 2015b General population (n=234 couples)	0.402 and 0.458 ng/mL (maternal and paternal geometric mean PFDeA)	Birth weight Birth length Head circumference Ponderal index	NS (p>0.05), maternal or paternal NS (p>0.05), maternal or paternal NS (p>0.05), maternal or paternal NS (p>0.05), maternal or paternal
Wang et al. 2016 General population (n=117 boys and 106 girls examined at 2, 5, 8, and 11 years of age)	0.46 and 0.43 ng/mL (median maternal PFDeA for boys and girls)	Birth weight Birth length Head circumference Small for gestational age	Inverse association (p>0.05)*, girls only NS (p>0.05) NS (p>0.05) OR 3.14 (1.07–9.19)*, girls only
PFUA			
Bach et al. 2016 General population (n=1,507 nulliparous women)	0.3 ng/mL (PFUA median)	Birth weight Birth length Head circumference	NS, investigators noted no consistent alterations across PFUA quartiles NS, investigators noted no consistent alterations across PFUA quartiles NS, investigators noted no consistent alterations across PFUA quartiles
Chen et al. 2012a General population (n=429 infants)	10.26 ng/mL (cord blood geometric mean PFUA)	Gestational age Birth weight Birth length	NS (p>0.05) NS (p>0.05) NS (p>0.05)

2. HEALTH EFFECTS

Table 2-23. Summary of Birth Outcomes in Humans^a

Reference and study population ^b	Serum perfluoroalkyl level	Outcome evaluated	Result ^c
		Head circumference	NS (p>0.05)
		Ponderal index	NS (p>0.05)
		Small for gestational age	OR 0.93 (0.65–1.33)
		Low birth weight	OR 1.01 (0.53–1.91)
Kim et al. 2016a	0.982 and 0.438 ng/mL (mean PFUA in cases and controls)	Thyroid stimulating immunoglobulin levels	NS (p>0.05)
General population (n=27 infants with congenital hypothyroidism; n=13 controls)		TSH	NS (p>0.05)
		T3	NS (p>0.05)
		T4	NS (p>0.05)
Lee et al. 2016	0.22 ng/mL (cord blood mean PFUA)	Birth weight	NS (p>0.05)
General population (n=85 infants)			
Lenters et al. 2016a, 2016b	0.70, 0.16, and 0.13 ng/mL (maternal median PFUA for Greenland, Ukraine, and Poland subcohorts)	Birth weight	NS (p=0.275)
General population (n=513 infants in Greenland subcohort, n=557 infants in Ukraine subcohort, and n=180 infants in Poland subcohort)			
Wang et al. 2016	3.52 and 3.31 ng/mL (median maternal PFUA for boys and girls)	Birth weight	Inverse association (p<0.05)*, girls only
General population (n=117 boys and 106 girls examined at age 2, 5, 8, and 11 years of age)		Birth length	NS (p>0.05)
		Head circumference	NS (p>0.05)
		Small for gestational age	OR 1.83 (1.01–3.32)*, girls only
PFHpA			
Kim et al. 2016a	0.284 and 0.324 ng/mL (mean PFHpA in cases and controls)	Thyroid stimulating immunoglobulin levels	NS (p>0.05)
General population (n=27 infants with congenital hypothyroidism; n=13 controls)		TSH	NS (p>0.05)
		T3	NS (p>0.05)
		T4	NS (p>0.05)

2. HEALTH EFFECTS

Table 2-23. Summary of Birth Outcomes in Humans^a

Reference and study population ^b	Serum perfluoroalkyl level	Outcome evaluated	Result ^c
PFBA			
Kim et al. 2016a	0.464 and 0.220 ng/mL (mean PFBA in cases and controls)	Thyroid stimulating immunoglobulin levels	NS (p>0.05)
General population (n=27 infants with congenital hypothyroidism; n=13 controls)		TSH	NS (p>0.05)
		T3	NS (p>0.05)
		T4	NS (p>0.05)
PFD_oA			
Lee et al. 2016	0.14 ng/mL (cord blood mean PFD _o A)	Birth weight	NS (p>0.05)
General population (n=85 infants)			
Lenters et al. 2016a, 2016b	0.13, 0.04, and 0.05 ng/mL (maternal median PFD _o A for Greenland, Ukraine, and Poland subcohorts)	Birth weight	NS (p=0.440)
General population (n=513 infants in Greenland subcohort, n=557 infants in Ukraine subcohort, and n=180 infants in Poland subcohort)			
Wang et al. 2016	0.37 and 0.37 ng/mL (median maternal PFD _o A for boys and girls)	Birth weight	Inverse association (p<0.05)*, girls only
General population (n=117 boys and 106 girls examined at 2, 5, 8, and 11 years of age)		Birth length	NS (p>0.05)
		Head circumference	Inverse association (p<0.05)*, girls only
		Small for gestational age	NS (p>0.05)
PFOSA			
Bae et al. 2015	0.11 and 0.10 ng/mL and 0.10 and 0.12 ng/mL (geometric mean PFOSA in male and female nulliparous parents and male and female parous parents, respectively)	Male birth	OR 1.07 (0.81–1.41), maternal PFOSA OR 1.14 (0.86–1.51), paternal PFOSA
General population (233 couples)			

2. HEALTH EFFECTS

Table 2-23. Summary of Birth Outcomes in Humans^a

Reference and study population ^b	Serum perfluoroalkyl level	Outcome evaluated	Result ^c
Robledo et al. 2015a, 2015b General population (n=234 couples)	0.112 and 0.114 ng/mL (maternal and paternal geometric mean PFOSA)	Birth weight	Inverse association (p<0.05)*, maternal only
		Boys	
		Girls	NS (p>0.05), maternal or paternal
		Birth length	NS (p>0.05), maternal or paternal
		Head circumference	NS (p>0.05), maternal or paternal
		Ponderal index	NS (p>0.05), maternal or paternal
Me-PFOSA-AcOH			
Bae et al. 2015 General population (233 couples)	0.29 and 0.28 ng/mL and 0.28 and 0.32 ng/mL (geometric mean Me-PFOSA- AcOH in male and female nulliparous parents and male and female parous parents, respectively)	Male birth	OR 0.98 (0.75–1.28), maternal Me-PFOSA-AcOH OR 0.80 (0.60–1.06), paternal Me-PFOSA-AcOH
		Female birth	OR 0.34 (0.13–0.89)*, paternal Me-PFOSA-AcOH 3rd tertile
Robledo et al. 2015a, 2015b General population (n=234 couples)	0.301 and 0.324 ng/mL (maternal and paternal geometric mean Me-PFOSA- AcOH)	Birth weight	NS (p>0.05), maternal or paternal
		Birth length	NS (p>0.05), maternal or paternal
		Head circumference	NS (p>0.05), maternal or paternal
		Ponderal index	NS (p>0.05), maternal or paternal
Et-PFOSA-AcOH			
Bae et al. 2015 General population (233 couples)	0.11 and 0.10 ng/mL and 0.10 and 0.11 ng/mL (geometric mean Et-PFOSA- AcOH in male and female nulliparous parents and male and female parous parents, respectively)	Male birth	OR 1.22 (0.92–1.60), maternal Et-PFOSA-AcOH OR 0.98 (0.75–1.29), paternal Et-PFOSA-AcOH

2. HEALTH EFFECTS

Table 2-23. Summary of Birth Outcomes in Humans^a

Reference and study population ^b	Serum perfluoroalkyl level	Outcome evaluated	Result ^c
Robledo et al. 2015a, 2015b	0.109 and 0.105 ng/mL (maternal and paternal geometric mean Et-PFOA- AcOH)	Birth weight	NS (p>0.05), maternal or paternal
General population (n=234 couples)		Birth length	NS (p>0.05), maternal or paternal
		Head circumference	NS (p>0.05), maternal or paternal
		Ponderal index	β -0.09 (-0.16 to -0.02)*, maternal NS (p>0.05), paternal

^aSee the *Supporting Document for Epidemiological Studies for Perfluoroalkyls*, Table 13 for more detailed descriptions of studies.

^bParticipants in occupational exposure may have also lived near the site and received residential exposure; community exposure studies involved subjects living near PFOA facilities with known exposure to high levels of PFOA.

^cAsterisk indicates association with perfluoroalkyl compound; unless otherwise specified, values in parenthesis are 95% confidence intervals.

BMI = body mass index; Et-PFOA-AcOH = 2-(N-ethyl-perfluorooctane sulfonamide) acetic acid; FSH = follicle stimulating hormone; HR = hazard ratio; LH = luteinizing hormone; Me-PFOA-AcOH = 2-(N-methyl-perfluorooctane sulfonamide) acetic acid; NS = not significant; NR = not reported; OR = odds ratio; PFDeA = perfluorodecanoic acid; PFDaA = perfluorododecanoic acid; PFHxS = perfluorohexane sulfonic acid; PFNA = perfluorononanoic acid; PFOA = perfluorooctanoic acid; PFOS = perfluorooctane sulfonic acid; PFOA = perfluorooctane sulfonamide; PFUA = perfluoroundecanoic acid; RR = relative risk; T3 = triiodothyronine; T4 = thyroxine; TSH = thyroid stimulating hormone

Table 2-24. Summary of Neurodevelopmental Outcomes in Humans^a

Reference and study population ^b	Serum perfluoroalkyl level	Outcome evaluated	Result ^c
PFOA			
Stein et al. 2013	115.9 ng/mL (estimated <i>in utero</i> mean PFOA)	Full scale IQ	β 4.61 (0.68–8.54)*, 4th quartile
Community (C8) (n=320 children 6–12 years old)		Reading and math skills	NS
		Scores on tests of ADHD (improvement)	β -8.49 (-16.14 to -0.84)*, 4th quartile
Stein et al. 2014a, 2014b	94.1–838.6 ng/mL (4 th PFOA quartile measured 3–4 years prior to behavioral assessment)	Executive function scores (mother completed survey)	β -6.39 (-11.43 to -1.35)*, 4th quartile boys
Community (C8) (n=321 children 6–12 years old)		Executive function scores (teacher completed survey)	β -6.39 (-0.03–8.87), 4 th quartile girls
			β -6.42 (-13.29–0.45), 4 th quartile boys β -1.92 (-10.39–6.55), 4 th quartile girls

2. HEALTH EFFECTS

Table 2-24. Summary of Neurodevelopmental Outcomes in Humans^a

Reference and study population ^b	Serum perfluoroalkyl level	Outcome evaluated	Result ^c
		ADHD-like behaviors (mother completed survey)	β -3.82 (-8.96–1.31), 4 th quartile boys β 6.99 (2.47–11.51)*, 4th quartile girls β 2.30 (-1.18–5.77), 4 th quartile boys and girls
		ADHD-like behaviors (teacher completed survey)	β -9.25 (-18.78–0.27), 4 th quartile boys β -3.65 (-10.85–3.51) 4 th quartile girls β -6.03 (-11.40 to -0.66)*, 4th quartile boys and girls
		Behavioral problems and emotional disturbances (mother completed survey)	β -1.55 (-5.91–2.82), 4 th quartile boys β 4.63 (0.72–8.53)*, 4th quartile girls
		Behavioral problems and emotional disturbances (teacher completed survey)	β -2.47 (-8.24–3.30), 4 th quartile boys β -0.91 (-6.19–4.37), 4 th quartile girls
Stein and Savitz 2011	65.3–2,070.6 ng/mL (4 th PFOA quartile)	ADHD	OR 0.76 (0.64–0.90)*, 4th quartile
Community (C8) (n=10,546 children aged 5–18 year)		Learning problems 12–15 years old 5–18 years old	OR 0.96 (0.73–1.26), 4 th quartile OR 0.90 (0.76–1.06), 4 th quartile
Braun et al. 2014	5.5 ng/mL (maternal median PFOA)	Social responsiveness scale score (measure of autistic behaviors)	β -2.0 (-4.4–0.4)
General population (n=175 children 4 and 5 years old)			
Chen et al. 2013	2.5 ng/mL (mean cord PFOA)	Poor performance on tests	NS OR 0.6 (0.08–4.8), whole test OR 1.3 (0.3–6.2), cognitive tests OR 0.5 (0.06–4.0), language tests OR 0.8 (0.1–4.7), gross motor tests OR 2.8 (0.6–13.5), fine motor tests OR 0.3 (0.02–2.7), social tests OR 3.2 (0.7–14.3), self-help tests
General population (239 children 2 years of age)			

2. HEALTH EFFECTS

Table 2-24. Summary of Neurodevelopmental Outcomes in Humans^a

Reference and study population ^b	Serum perfluoroalkyl level	Outcome evaluated	Result ^c
Donauer et al. 2015 General population (n=349 infants at 5 weeks of age)	5.49 ng/mL (maternal geometric mean PFOA)	Social/easy going	NS (p>0.05)
		Hypotonic	OR 3.79 (1.1–12.8)* per 10-fold increase in PFOA
		High arousal/difficult	NS (p=0.3533)
Fei et al. 2008b General population (n=1,400 infants)	5.6 ng/mL (maternal median PFOA)	Apgar scores <10	OR 1.14 (0.57–2.25)
		Motor and mental development at 6 months	NS (p>0.05)
		Neurobehavioral milestones at 18 months	NS (p>0.05)
Fei and Olsen 2011 General population (n=526–787 7-year-old children)	5.4 ng/mL (maternal median PFOA)	Behavioral problems	NS (p>0.15 for trend)
		Motor coordination	NS (p=0.89 for trend)
Forns et al. 2015 General population (n=843 infants)	40 ng/L (median PFOA breast milk level)	Risk of an abnormal score on neurobehavioral assessment questionnaire	OR 1.05 (0.77-1.44) at 6 months of age OR 1.0 (0.78-1.28) at 24 months of age
Goudarzi et al. 2016 General population (n=173 infants at 6 months and 133 at 18 months)	1.2 ng/mL (maternal median PFOA)	MDI/PDI at 6 months of age	NS (p>0.05), boys and girls Inverse association (p<0.05)*, females
		MDI/PDI at 18 months of age	NS (p>0.05)
Gump et al. 2011 General population (n=83 children aged 9–11 years)	3.23 ng/mL (mean PFOA)	Performance on task requiring behavioral inhibition	NS (p>0.05)
Hoffman et al. 2010 General population (NHANES) (n=571 children 12–15 years)	4.4 ng/mL (median PFOA)	ADHD (parent reported)	OR 1.12 (1.01–1.23)*, per 1 ng/mL PFOA

2. HEALTH EFFECTS

Table 2-24. Summary of Neurodevelopmental Outcomes in Humans^a

Reference and study population ^b	Serum perfluoroalkyl level	Outcome evaluated	Result ^c
Høyer et al. 2015a General population (n=1,106 children aged 5–9 years)	1.4 and 1.9–9.8 ng/mL (maternal median and 3 rd tertile PFOA)	Motor skills	β -0.2 (-1.2–0.9)
		Abnormal behavior	OR 2.7 (1.2–6.3)*, 3rd tertile
		Hyperactivity	OR 3.1 (1.3–7.2)*, 3rd tertile
Lien et al. 2016 General population (n=282 children aged 7 years)	1.55 ng/mL (cord blood weighted average PFOA)	Inattention	NS (p=0.7758)
		Hyperactivity/impulsivity	NS (p=0.2997)
		Emotional symptoms	NS (p=0.691)
		Conduct problems	NS (p=0.2664)
		Hyperactivity/inattention	NS (p=0.774)
Liew et al. 2015 General population (n=215, ADHD cases, 213 autism cases, 545 controls)	4.06, 3.88, and 4.00 ng/mL (maternal median PFOA for ADHD, autism, and controls)	ADHD	RR 0.98 (0.82–1.16)
		Autism	RR 0.98 (0.73–1.31)
Ode et al. 2014 General population (n=206 children with ADHD and 206 controls; children were 5–17 years old at time of diagnosis)	1.80 and 1.83 ng/mL (cord blood median PFOA in cases and controls)	ADHD	OR 0.98 (0.91–1.02), per 1 ng/mL increase in PFOA
Quaak et al. 2016 General population (n=76 infants 18 months of age)	0.9056 ng/mL (cord mean PFOA)	Score on test evaluating ADHD	NS (p=0.72), 3 rd tertile
		Males	NS (p=0.22), 3 rd tertile
		Females	NS (p=0.31), 3 rd tertile
		Scores on test evaluating externalizing problem	NS (p=0.31), 3 rd tertile
		Males	Association (p=0.05 and 0.09)*, 2nd and 3rd tertiles
Females	NS (p=0.74), 3 rd tertile		
Strøm et al. 2014 General population (n=876 adults age 20 years)	3.7 ng/mL (median maternal PFOA)	ADHD	NS (p=0.45 for trend of 3 rd tertile)
		Depression	NS (p=0.28 for trend of 3 rd tertile)
		Scholastic achievement	NS (p=0.21 for trend of 3 rd tertile)

2. HEALTH EFFECTS

Table 2-24. Summary of Neurodevelopmental Outcomes in Humans^a

Reference and study population ^b	Serum perfluoroalkyl level	Outcome evaluated	Result ^c
Vuong et al. 2016 General population (n=256 children aged 5 or 8 years)	5.4 ng/mL (maternal median PFOA)	Behavioral regulation	β 1.11(-1.22–3.44)
		Metacognition	β 0.58 (-1.77–2.93)
		Global executive functioning	β 1.06 (-1.33–3.45)
Wang et al. 2015b General population (n=120 children age 5 years and 120 children aged 8 years)	2.50 and 2.50 ng/mL (maternal median PFOA for 5 and 8 year olds)	IQ score	
		Age 5 years Age 8 years	NS NS
PFOS			
Stein and Savitz 2011 Community (C8) (n=10,546 children aged 5–18 years)	14.8–<20.2, 20.22–<27.9, and 27.9–202.1 ng/mL (2 nd , 3 rd , and 4 th PFOS quartiles)	ADHD	OR 0.99 (0.76–1.30), 4 th quartile
		Learning problems 5–18 years old 12–15 years old	OR 0.83 (0.70–0.98)*, 2nd quartile OR 0.68 (0.52–0.89)*, 3rd quartile
Braun et al. 2014 General population (n=175 children 4 and 5 years old)	13 ng/mL (maternal PFOS median)	Social responsiveness scale score (test of autism)	No association
Donauer et al. 2015 General population (n=349 infants)	13.25 ng/mL (maternal geometric mean PFOS)	Neurobehavioral outcomes	NS (p>0.05)
		Hypotonic	NS (p=0.3996)
		High arousal/difficult	NS (p=0.4678)
Fei et al. 2008b General population (n=1,400 infants)	35.3 ng/mL (maternal median PFOS)	Apgar scores <10	OR 1.20 (0.67–2.14)
		Neurobehavioral milestones	
		Delay in age of sitting	Association (p=0.041 for trend)*
		Earlier use of word-like sounds	Association (p=0.039 for trend)*
		Delays in using 2-word sentences	Association (p=0.050 for trend)*
		Other milestones	NS (p>0.05)
Motor and mental development at 6 months	NS (p>0.05)		

2. HEALTH EFFECTS

Table 2-24. Summary of Neurodevelopmental Outcomes in Humans^a

Reference and study population ^b	Serum perfluoroalkyl level	Outcome evaluated	Result ^c
Fei and Olsen 2011 General population (n=526–787 children)	34.4 ng/mL (maternal median PFOS)	Behavioral health	NS (p>0.39 for trend)
		Motor coordination	NS (p=0.41 for trend)
Forns et al. 2015 General population (n=843 infants)	110 ng/L (median PFOS breast milk level)	Risk of an abnormal score on neurobehavioral assessment questionnaire	OR 0.96 (0.76-1.20) at 6 months of age OR 0.93 (0.74-1.17) at 24 months of age
		Goudarzi et al. 2016 General population (n=173 at 6 months and 133 at 18 months)	5.7 ng/mL (maternal median PFOS)
Gump et al. 2011 General population (n=83 children aged 9–11 years)	9.90 ng/mL (mean PFOS)	Performance on task requiring behavioral inhibition	Inverse association (p<0.05)*
		Hoffman et al. 2010 General population (NHANES) (n=571 children 12–15 years)	22.6 ng/mL (median PFOS)
Høyer et al. 2015a General population (n=1,106 children)	10.0 and 16.6–87.3 ng/mL (maternal median and 3 rd tertile PFOS)	Motor skills	β -0.1 (-1.2–1.1)
		Abnormal behavior	OR 1.5 (0.5–4.8), 3 rd tertile
		Hyperactivity	OR 1.4 (0.4–4.9), 3 rd tertile
Lien et al. 2016 General population (n=282 children aged 7 years)	4.79 ng/mL (cord blood weighted average PFOS)	Inattention	NS (p=0.8508)
		Hyperactivity/impulsivity	NS (p=0.6857)
		Emotional symptoms	NS (p=0.9431)
		Conduct problems	NS (p=0.4938)
		Hyperactivity/inattention	NS (p=0.5226)
Liew et al. 2015 General population (n=215, ADHD cases, 213 autism cases, 545 controls)	26.80, 25.40, and 27.40 ng/mL (maternal median PFOS for ADHD, autism, and controls)	ADHD	RR 0.87 (0.74–1.02) RR 0.79 (0.64–0.98)*, 4th quartile
		Autism	RR 0.92 (0.69–1.22)

2. HEALTH EFFECTS

Table 2-24. Summary of Neurodevelopmental Outcomes in Humans^a

Reference and study population ^b	Serum perfluoroalkyl level	Outcome evaluated	Result ^c
Ode et al. 2014 General population (n=206 children with ADHD and 206 controls)	6.92 and 6.77 ng/mL (cord blood median PFOS in cases and controls)	ADHD	OR 0.98 (0.92–1.04), per 1 ng/mL increase in PFOS
Quaak et al. 2016 General population (n=76 infants 18 months of age)	1.5836 ng/mL (cord mean PFOS)	Score on test evaluating ADHD Males Females Scores on test evaluating externalizing problem Males Females	NS (p=0.19), 3 rd tertile NS (p=0.35), 3 rd tertile NS (p=0.43), 3 rd tertile NS (p=0.31), 3 rd tertile NS (p=0.74), 3 rd tertile NS (p=0.31), 3 rd tertile
Strøm et al. 2014 General population (n=876 adults age 20 years)	21.4 ng/mL (median maternal PFOS)	ADHD Depression Scholastic achievement	NS (p=0.38 for trend of 3 rd tertile) NS (p=0.14 for trend of 3 rd tertile) NS (p=0.59 for trend of 3 rd tertile)
Vuong et al. 2016 General population (n=256 children 5 or 8 years of age)	13.2 ng/mL (maternal median PFOS)	Behavioral regulation Metacognition Global executive functioning Global executive functioning composite score >60	β 3.14 (0.68–5.61)* β 3.10 (0.62–5.58)* β 3.38 (0.86–5.90)* OR 2.19 (1.03–4.66)*
Wang et al. 2015b General population (n=120 children age 5 years and 120 children aged 8 years)	13.25 and 12.28 ng/mL (maternal median PFOS for 5 and 8 year olds)	IQ score Age 5 years Age 8 years	NS (p>0.05) NS (p>0.05)
PFHxS			
Stein and Savitz 2011 Community (C8) (n=10,546 children aged 5–18 years)	2.9–<5.2 and 10.1–276.4 ng/mL (2 nd and 4 th PFHxS quartiles)	ADHD 5–18 years 12–15 years Learning problems 5–18 years old 12–15 years old	OR 1.27 (1.06–1.52)*, 2nd quartile OR 1.46 (1.10–1.93)*, 2nd quartile OR 1.19 (1.00–1.41), 4 th quartile OR 1.05 (0.79–1.40), 4 th quartile

2. HEALTH EFFECTS

Table 2-24. Summary of Neurodevelopmental Outcomes in Humans^a

Reference and study population ^b	Serum perfluoroalkyl level	Outcome evaluated	Result ^c
Braun et al. 2014 General population (n=175 children 4 and 5 years old)	1.6 ng/mL (maternal PFHxS median)	Social responsiveness scale score (test for autism)	No association
Gump et al. 2011 General population (n=83 children aged 9–11 years)	6.06 ng/mL (mean PFHxS)	Performance on task requiring behavioral inhibition	Inverse association (p<0.01)*
Hoffman et al. 2010 General population (NHANES) (n=571 children 12–15 years)	2.2 ng/mL (median PFHxS)	ADHD (parent reported)	OR 1.06 (1.02–1.11)*, per 1 ng/mL PFOS
Liew et al. 2015 General population (n=215, ADHD cases, 213 autism cases, 545 controls)	0.84, 0.92, and 0.92 ng/mL (maternal median PFHxS for ADHD, autism, and controls)	ADHD Autism	RR 0.67 (0.54–0.83)*, 4th quartile RR 1.10 (0.92–1.33)
Vuong et al. 2016 General population (n=256 children 5 or 8 years of age)	1.5 ng/mL (maternal median PFHxS)	Behavioral regulation Metacognition Global executive functioning Global executive functioning composite score >60	β 1.19 (-0.54–5.40) β 1.31 (-0.43–3.04) β 1.36 (-0.41–3.12) OR 1.71 (1.05–2.77)*
Wang et al. 2015b General population (n=120 children age 5 years and 120 children aged 8 years)	0.69 and 0.69 ng/mL (maternal median PFHxS for 5 and 8 year olds)	IQ score Age 5 years Age 8 years	NS (p>0.05) NS (p>0.05)
PFNA			
Stein and Savitz 2011 Community (C8) (n=10,546 children aged 5–18 years)	1.2–<1.5, 1.5–<2.0, and 2.0–24.1 ng/mL (2 nd , 3 rd , and 4 th PFNA quartiles)	ADHD 5–18 years 12–15 years Learning problems 5–18 years old 12–15 years old	OR 0.99 (0.84–1.18), 4 th quartile OR 1.00 (0.75–1.32), 4 th quartile OR 0.81 (0.69–0.95)*, 3rd quartile OR 0.73 (0.55–0.98)*, 4th quartile

2. HEALTH EFFECTS

Table 2-24. Summary of Neurodevelopmental Outcomes in Humans^a

Reference and study population ^b	Serum perfluoroalkyl level	Outcome evaluated	Result ^c
Braun et al. 2014 General population (n=175 children 4 and 5 years old)	0.9 ng/mL (maternal PFNA median)	Social responsiveness scale score (tests for autism)	No association
Gump et al. 2011 General population (n=83 children aged 9–11 years)	0.82 ng/mL (mean PFNA)	Performance on task requiring behavioral inhibition	Inverse association (p<0.05)*
Hoffman et al. 2010 General population (NHANES) (n=571 children 12–15 years)	0.6 ng/mL (median PFNA)	ADHD (parent reported)	OR 1.32 (0.86–2.02), per 1 ng/mL PFNA
Lien et al. 2016 General population (n=282 children aged 7 years)	4.49 ng/mL (cord blood weighted average PFNA)	Inattention	Inverse association (p=0.0129)*
		Hyperactivity/impulsivity	NS (p=0.0588)
		Emotional symptoms	NS (p=0.1902)
		Conduct problems	NS (p=0.6931)
Liew et al. 2015 General population (n=215, ADHD cases, 213 autism cases, 545 controls)	0.42, 0.41, and 0.43 ng/mL (maternal median PFNA for ADHD, autism, and controls)	ADHD	RR 0.80 (0.62–1.03)
		Autism	RR 0.80 (0.58–1.11)
Vuong et al. 2016 General population (n=256 children 5 or 8 years of age)	0.9 ng/mL (maternal median PFNA)	Behavioral regulation	β 2.57 (-0.26–5.40)
		Metacognition	β 1.37 (-1.49–4.23)
		Global executive functioning	β 2.01 (-0.89–4.92)
Wang et al. 2015b General population (n=120 children age 5 years and 120 children aged 8 years)	1.59 and 1.44 ng/mL (maternal median PFNA for 5 and 8 year olds)	IQ score	NS (p>0.05)
		IQ scores, age 8 years	
		Full scale IQ	NS (p>0.05)
		Visual IQ	Association (p<0.05)*
		Performance IQ	NS (p>0.05)

2. HEALTH EFFECTS

Table 2-24. Summary of Neurodevelopmental Outcomes in Humans^a

Reference and study population ^b	Serum perfluoroalkyl level	Outcome evaluated	Result ^c
PFDeA			
Gump et al. 2011 General population (n=83 children aged 9–11 years)	0.26 ng/mL (mean PFDeA)	Performance on task requiring behavioral inhibition	Inverse association (p<0.05)*
Liew et al. 2015 General population (n=215, ADHD cases, 213 autism cases, 545 controls)	0.15, 0.15, and 0.17 ng/mL (maternal median PFDeA for ADHD, autism, and controls)	ADHD Autism	RR 0.76 (0.64–0.91)* RR 0.53 (0.43–0.66)*, 4th quartile RR 0.79 (0.63–1.01) RR 0.52 (0.35–0.77)*, 4th quartile
Vuong et al. 2016 General population (n=256 children 5 or 8 years of age)	0.2 ng/mL (maternal median PFDeA)	Behavioral regulation Metacognition Global executive functioning	β 0.70 (-3.31–1.92) β 1.24 (-3.87–1.39) β -1.13 (-3.79–1.54)
Wang et al. 2015b General population (n=120 children age 5 years and 120 children aged 8 years)	0.44 and 0.44 ng/mL (maternal median PFDeA for 5 and 8 year olds)	IQ score Age 5 years Age 8 years	NS (p>0.05) NS (p>0.05)
PFUA			
Lien et al. 2016 General population (n=282 children aged 7 years)	7.96 ng/mL (cord blood weighted average PFUA)	Inattention Hyperactivity/impulsivity Emotional symptoms Conduct problems Hyperactivity/inattention	NS (p=0.6177) NS (p=0.3642) NS (p=0.0517) NS (p=0.1207) NS (p=0.9991)
Wang et al. 2015b General population (n=120 children age 5 years and 120 children aged 8 years)	3.42 and 3.13 ng/mL (maternal median PFUA for 5 and 8 year olds)	IQ score IQ scores, age 8 years Full scale IQ Visual IQ Performance IQ	NS (p>0.05) NS (p>0.05) NS (p>0.05) Inverse association (p<0.05)*

2. HEALTH EFFECTS

Table 2-24. Summary of Neurodevelopmental Outcomes in Humans^a

Reference and study population ^b	Serum perfluoroalkyl level	Outcome evaluated	Result ^c
PFD_oA			
Wang et al. 2015b	0.38 and 0.37 ng/mL (maternal median PFD _o A for 5 and 8 year olds)	IQ score Age 5 years Age 8 years	NS (p>0.05) NS (p>0.05)
General population (n=120 children age 5 years and 120 children aged 8 years)			
PFOSA			
Gump et al. 2011	0.75 ng/mL (mean PFOSA)	Performance on task requiring behavioral inhibition	Inverse association (p<0.05)*
General population (n=83 children aged 9– 11 years)			

^aSee the *Supporting Document for Epidemiological Studies for Perfluoroalkyls*, Table 13 for more detailed descriptions of studies.

^bParticipants in occupational exposure may have also lived near the site and received residential exposure; community exposure studies involved subjects living near PFOA facilities with known exposure to high levels of PFOA.

^cAsterisk indicates association with perfluoroalkyl compound; unless otherwise specified, values in parenthesis are 95% confidence intervals.

ADHD = attention deficit hyperactivity disorder; MDI/PDI = mental and psychomotor development indices; NHANES = National Health and Nutrition Examination Survey; NS = not significant; OR = odds ratio; PFDeA = perfluorodecanoic acid; PFD_oA = perfluorododecanoic acid; PFHxS = perfluorohexane sulfonic acid; PFNA = perfluorononanoic acid; PFOA = perfluorooctanoic acid; PFOS = perfluorooctane sulfonic acid; PFOSA = perfluorooctane sulfonamide; PFUA = perfluoroundecanoic acid

2. HEALTH EFFECTS

Table 2-25. Summary of Effects on the Development of the Reproductive System in Humans^a

Reference and study population ^b	Serum perfluoroalkyl level	Outcome evaluated	Result ^c
PFOA			
Lopez-Espinosa et al. 2011	26 and 20 ng/mL (median PFOA in boys and girls)	Age of puberty Boys Girls	OR 0.95 (0.84–0.07) OR 0.54 (0.35–0.84)*, 2nd quartile
Community (C8) (n=3,076 boys and 2,931 girls aged 8–18 years)			
Lopez-Espinosa et al. 2016	34.8 and 30.1 ng/mL (median PFOA in boys and girls)	Estradiol	NS (interquartile difference of 4.3, 95% CI -0.4–9.1), boys NS (4.2, 95% CI -0.7–9.4), girls
Community (C8) (n=1,169 boys and 1,123 girls aged 6–9 years)		Total testosterone	Inverse association (-4.9, 95% CI -8.7 to -0.8)*, boys NS (-2.5, 95% CI -6.7–1.8), girls
		Insulin-like growth factor-1	NS (-0.4, 95% CI -3.4–2.7), boys Inverse association (-3.6, 95% CI -6.6 to -0.5)*, girls
Christensen et al. 2011	3.7 ng/mL (maternal median PFOA)	Earlier age of menarche	OR 1.01 (0.61–1.68)
General population (n=448 girls)			
Itoh et al. 2016	1.4 ng/mL (maternal median PFOA)	Cord estradiol	NS (p>0.05)
General population (n=189 infants)		Cord testosterone	NS (p>0.05)
		Cord testosterone: estradiol ratio	NS (p>0.05)
		Cord progesterone	NS (p>0.05)
		Cord prolactin	NS (p>0.05)
		Cord LH	NS (p>0.05)
		Cord FSH	NS (p>0.05)
		Cord SHGB	NS (p>0.05)
		Cord insulin-like factor 3	NS (p>0.05)
		Cord inhibin Males Females	Association (p=0.040)* NS (p>0.05)

2. HEALTH EFFECTS

Table 2-25. Summary of Effects on the Development of the Reproductive System in Humans^a

Reference and study population ^b	Serum perfluoroalkyl level	Outcome evaluated	Result ^c
Kristensen et al. 2013 General population (n=343 females approximately 20 years of age)	3.6 and 4.4–19.8 ng/mL (maternal median PFOA and 3 rd PFOA tertile)	Age of menarche	Association (p=0.01)*
		Menstrual cycle length	NS (p>0.05)
		Total testosterone	NS (p>0.05)
		SHBG	NS (p>0.05)
		Free androgen index	NS (p>0.05)
		Dehydroepiandrosterone sulphate	NS (p>0.05)
		Anti-Müllerian hormone	NS (p>0.05)
		Number of follicles/ovary	NS (p>0.05)
Maisonet et al. 2015 General population (n=72 girls aged 15 years)	>4.1 ng/mL (maternal 3 rd tertile PFOA)	Testosterone	β 0.24 (0.05–0.43)*, 3rd tertile
		SHBG	β 5.02 (-13.07–11.00), 3 rd tertile
Vesterholm Jensen et al. 2014 General population (n=107 cases cryptorchidism [29 from Denmark and 78 from Finland] and 108 matched controls from Denmark and Finland)	2.6 and 2.1 ng/mL (median cord blood PFOA Denmark and Finland cohorts)	Cryptorchidism	OR 0.51 (0.21–1.20), whole cohort OR 0.35 (0.12–0.99, p=0.04 for trend)*, Finland cohort 3rd tertile
PFOS			
Lopez-Espinosa et al. 2011 Community (C8) (n=3,076 boys and 2,931 girls aged 8–18)	20 and 18 ng/mL (PFOS median in boys and girls)	Age of puberty	OR 0.58 (0.37–0.90)*, 3rd quartile OR 0.55 (0.35–0.86)*, 3rd quartile
		Boys	
Lopez-Espinosa et al. 2016 Community (C8) (n=1,169 boys and 1,123 girls aged 6–9 years)	22.4 and 20.9 ng/mL (PFOS median in boys and girls)	Estradiol	Inverse association (interquartile difference of -4.0, 95% CI -7.7 to -0.1)*, boys NS (-0.3, 95% CI -4.6–4.2), girls
		Total testosterone	Inverse association (-5.8, 95% CI -9.4 to -2.0)*, boys Inverse association (-6.6, 95% CI -10.1 to -2.8)*, girls

2. HEALTH EFFECTS

Table 2-25. Summary of Effects on the Development of the Reproductive System in Humans^a

Reference and study population ^b	Serum perfluoroalkyl level	Outcome evaluated	Result ^c
		Insulin-like growth factor-1	Inverse association (-5.9, 95% CI -8.3 to -3.3)*, boys Inverse association (-5.6, 95% CI -8.2 to -2.9)*, girls
Christensen et al. 2011 General population (n=448 girls)	19.8 ng/mL (maternal median PFOS)	Earlier age of menarche	OR 0.68 (0.40–1.13)
Itoh et al. 2016 General population (n=189 infants)	5.2 ng/mL (maternal median PFOS)	Cord estradiol Males Females	Association (p=0.021)* NS (p>0.05)
		Cord testosterone	NS (p>0.05)
		Cord testosterone: estradiol ratio Males Females	Inverse association (p=0.008)* NS (p>0.05)
		Cord progesterone Males Females	Association (p=0.043)* Association (p=0.002)*
		Cord prolactin Males Females	NS (p>0.05) Association (p=0.001)*
		Cord LH	NS (p>0.05)
		Cord FSH	NS (p>0.05)
		Cord SHGB	NS (p>0.05)
		Cord insulin-like factor 3	NS (p>0.05)
		Cord inhibin Males Females	Association (p<0.001)* NS (p>0.05)

2. HEALTH EFFECTS

Table 2-25. Summary of Effects on the Development of the Reproductive System in Humans^a

Reference and study population ^b	Serum perfluoroalkyl level	Outcome evaluated	Result ^c
Kristensen et al. 2013 General population (n=343 young women approximately 20 years of age)	21.1 ng/mL (maternal median PFOS)	Age of menarche	NS (p=0.28)
		Menstrual cycle length	NS (p>0.05)
		Total testosterone	NS (p>0.05)
		SHBG	NS (p>0.05)
		Free androgen index	NS (p>0.05)
		Dehydroepiandrosterone sulphate	NS (p>0.05)
		Anti-Müllerian hormone	NS (p>0.05)
		Number of follicles/ovary	NS (p>0.05)
Toft et al. 2016 General population (270 cases cryptorchidism, 75 cases hypospadias, and 300 controls)	>1.4 ng/mL (amniotic fluid 3 rd tertile PFOS)	Cryptorchidism	OR 1.01 (0.66–1.53), 3 rd tertile
		Hypospadias	OR 0.69 (0.35–1.38), 3 rd tertile
		Testosterone	Association (p=0.002)*
		Androstendione	Association (p=0.001)*
		Progesterone	Association (p=0.001)*
		Cortisol	Association (p<0.001)*
		DHEAS	NS (p=0.93)
		Insulin-like factor 3	Inverse association (p<0.001)*
Vesterholm Jensen et al. 2014 General population (n=107 cases cryptorchidism [29 from Denmark and 78 from Finland] and 108 matched controls from Denmark and Finland)	9.1 and 5.2 ng/mL (median cord blood PFOS Denmark and Finland cohorts)	Cryptorchidism	OR 0.83 (0.44–1.58), whole cohort

2. HEALTH EFFECTS

Table 2-25. Summary of Effects on the Development of the Reproductive System in Humans^a

Reference and study population ^b	Serum perfluoroalkyl level	Outcome evaluated	Result ^c
PFHxS			
Lopez-Espinosa et al. 2016 Community (C8) (n=1,169 boys and 1,123 girls aged 6–9 years)	8.1 and 7.0 ng/mL (PFHxS median in boys and girls)	Estradiol	NS (interquartile difference of -1.3, 95% CI -5.5–3.1), boys NS (2.1, 95% CI -2.2–6.5), girls
		Total testosterone	NS (-2.7, 95% CI -6.4–1.2), boys NS (0.2, 95% CI -3.5–4.0), girls
		Insulin-like growth factor-1	NS (-2.5, 95% CI -5.2–0.3), boys NS (-2.1, 95% CI -4.8–0.7), girls
Christensen et al. 2011 General population (n=448 girls)	1.6 ng/mL (maternal median PFHxS)	Earlier age of menarche	OR 0.89 (0.65–1.22)
Maisonet et al. 2015 General population (n=72 girls aged 15 years)	>1.9 ng/mL (maternal 3 rd tertile PFHxS)	Testosterone	β 0.18 (0.00–0.35), 3 rd tertile
		SHBG	β 5.31 (-21.61–11.00), 3 rd tertile
PFNA			
Lopez-Espinosa et al. 2016 Community (C8) (n=1,169 boys and 1,123 girls aged 6–9 years)	1.7 and 1.7 ng/mL (PFNA median in boys and girls)	Estradiol	NS (interquartile difference of -2.5, 95% CI -6.2–1.4), boys NS (-2.4, 95% CI -6.3–1.7), girls
		Total testosterone	NS (-2.1, 95% CI -5.5–1.3), boys NS (-1.9, 95% CI -5.5–1.9), girls
		Insulin-like growth factor-1	Inverse association (-3.5, 95% CI -6.0 to -1.0)*, boys Inverse association (-3.8, 95% CI -6.4 to -1.2)*, girls
Maisonet et al. 2015 General population (n=72 girls aged 15 years)	>0.6 ng/mL (maternal 3 rd tertile PFNA)	Testosterone	β 0.05 (-0.14–0.24), 3 rd tertile
		SHBG	β 7.91 (-8.69–24.52), 3 rd tertile
PFOSA			
Christensen et al. 2011 General population (n=448 girls)	0.2 ng/mL (maternal median PFOSA)	Earlier age of menarche	OR 0.91 (0.67–1.24)
Me-PFOSA-AcOH			

2. HEALTH EFFECTS

Table 2-25. Summary of Effects on the Development of the Reproductive System in Humans^a

Reference and study population ^b	Serum perfluoroalkyl level	Outcome evaluated	Result ^c
Christensen et al. 2011 General population (n=448 girls)	0.4 ng/mL (maternal median Me-PFOSA-AcOH)	Earlier age of menarche	OR 0.86 (0.66–1.12)
Et-PFOSA-AcOH			
Christensen et al. 2011 General population (n=448 girls)	0.6 ng/mL (maternal median Et-PFOSA-AcOH)	Earlier age of menarche	OR 1.03 (0.75–1.43)

^aSee the *Supporting Document for Epidemiological Studies for Perfluoroalkyls*, Table 13 for more detailed descriptions of studies.

^bParticipants in occupational exposure may have also lived near the site and received residential exposure; community exposure studies involved subjects living near PFOA facilities with known exposure to high levels of PFOA.

^cAsterisk indicates association with perfluoroalkyl compound; unless otherwise specified, values in parenthesis are 95% confidence intervals.

CI = confidence interval; DHEAS = dihydroepiandrosterone sulfate; Et-PFOSA-AcOH = 2-(N-ethyl-perfluorooctane sulfonamide) acetic acid; FSH = follicle stimulating hormone; LH = luteinizing hormone; Me-PFOSA-AcOH = 2-(N-methyl-perfluorooctane sulfonamide) acetic acid; NS = not significant; OR = odds ratio; PFHxS = perfluorohexane sulfonic acid; PFNA = perfluorononanoic acid; PFOA = perfluorooctanoic acid; PFOS = perfluorooctane sulfonic acid; SHBG = sex hormone binding globulin

2. HEALTH EFFECTS

Document for Epidemiological Studies for Perfluoroalkyls, Table 13. Studies examining childhood growth and examining the possible relationship between maternal serum perfluoroalkyl levels and body weight and BMI in children and adults are discussed in Section 2.3, Body Weight. In general, the epidemiology studies did not find associations between perfluoroalkyl exposure and adverse pregnancy outcomes (miscarriage, preterm birth, or gestational age) for PFOA, PFOS, PFHxS, PFNA, or PFUA. Mixed results have been found for birth outcomes, particularly birth weight. Some epidemiology studies have found associations between maternal PFOA or PFOS exposure and decreases in birth weight, and meta-analyses of these data have found that increases in maternal PFOA or PFOS were associated with 15–19 g or 5 g decreases in birth weight, respectively; accounting for maternal glomerular filtration rates attenuated these results by about 50%. No consistent associations for alterations in birth weight were found for other perfluoroalkyls (PFHxS, PFNA, PFDeA, PFUA, PFDoA, Me-PFOSA-AcOH, Et-PFOSA-AcOH). Overall, no associations were found between serum PFOA, PFOS, PFHxS, PFNA, or PFUA and increases in the risk of low birth weight or small for gestational age infants. No consistent results for risks of birth defects have been found; these potential endpoints were only examined for a few perfluoroalkyls. The available epidemiology data do not suggest associations between perfluoroalkyls and IQ or scholastic achievement for PFOA, PFOS, PFHxS, PFNA, PFDeA, PFUA, or PFDoA. Similarly, no associations were found between PFOA, PFOS, PFHxS, PFNA, or PFDeA and increased risk of ADHD; several studies have found decreased risk of ADHD. Inconsistent results have been found between PFOA and PFOS and delays in puberty or age of puberty, especially in girls.

Summaries of laboratory animal studies are presented in Tables 2-1, 2-3, 2-4, and 2-5 and the NOAEL and LOAEL values are presented in Figures 2-4, 2-6, 2-7, and 2-8. Laboratory animal studies provide strong evidence of the developmental toxicity of a number of perfluoroalkyl compounds. Prenatal losses and decreases in pup survival were observed following exposure to PFOA, PFOS, PFNA, and PFDeA; no deaths were observed in a single study of PFBuS. Decreases in fetal weights, birth weight, and pup weight were observed in studies of PFOA, PFOS, PFNA, PFDeA, and PFUA; no effects on weight were observed in studies on PFHxS or PFBuS. In PFOA studies, delays in mammary gland development were observed at fairly low doses. Several studies have demonstrated biphasic alterations in motor activity in rodents exposed to PFOA, PFOS, and PFHxS; no effects on locomotor activity were observed in a study of PFDeA. Studies in laboratory animals have examined a number of developmental endpoints, including pup survival, malformations, birth weight, mammary gland development, and neurodevelopment.

2. HEALTH EFFECTS

PFOA

Epidemiology Studies—Pregnancy Outcomes. The results of available epidemiology studies of women living near a PFOA facility and the general population do not suggest an association between serum PFOA levels and adverse pregnancy outcomes. No increases in risk of miscarriage (Darrow et al. 2014; Jensen et al. 2015; Savitz et al. 2012b; Stein et al. 2009), stillbirths (Savitz et al. 2012b), or pre-term birth (Chen et al. 2012a; Darrow et al. 2013; Hamm et al. 2010; Stein et al. 2009; Whitworth et al. 2012a) were found; the Whitworth et al. (2012a) general population studies reported a decrease in the risk of preterm births among women with serum PFOA levels in the 4th quartile. Additionally, Apelberg et al. (2007b) and Chen et al. (2012a) did not find associations between maternal serum PFOA levels and gestational age.

Epidemiology Studies—Birth Outcomes. Community and general population exposure studies have evaluated a number of birth outcomes including birth weight; risk of low birth weight; risk of small for gestational age; birth length; head, chest, and abdominal circumferences; ponderal index; sex ratio; and birth defects. In highly exposed populations, no association between maternal serum PFOA levels and birth weight were found (Darrow et al. 2013; Nolan et al. 2009; Savitz et al. 2012b). Several general population studies have found associations between maternal serum PFOA and birth weight. Fei et al. (2007, 2008a), Lenters et al. (2016a), and Maisonet et al. (2012) found an inverse association between maternal serum PFOA and birth weight. However, 12 other general population studies did not find associations (Bach et al. 2016; Chen et al. 2012a; Govarts et al. 2016; Hamm et al. 2010; Kim et al. 2011; Lee et al. 2013, 2016; Monroy et al. 2008; Robledo et al. 2015a; Wang et al. 2016; Washino et al. 2009; Whitworth et al. 2012a). As illustrated in Figure 2-33, most studies found no association between maternal serum PFOA levels and the risk of low birth weight infants (typically defined as <2,500 g) (Chen et al. 2012a; Darrow et al. 2013; Fei et al. 2007, 2008a; Savitz et al. 2012b; Stein et al. 2009) or found a decreased risk of low birth weight infants (Nolan et al. 2009; Savitz et al. 2012a). Similarly, there were no increases in the risk for small for gestational age (Chen et al. 2012a; Fei et al. 2007, 2008a; Hamm et al. 2010; Savitz et al. 2012b; Wang et al. 2016; Whitworth et al. 2012a); these data are presented in Figure 2-34. One study (Savitz et al. 2012b) of C8 participants did find an increase in the risk of small for gestational age; however, when the maternal serum PFOA levels were categorized into percentiles, the risk was not increased in infants whose maternal serum PFOA levels were $\geq 80^{\text{th}}$ percentile (21.0–717.6 ng/mL). Two general population studies found inverse associations between maternal serum PFOA levels and birth length, abdominal circumference, and/or ponderal index (ratio of birth weight to birth length) (Apelberg et al. 2007b; Fei et al. 2007, 2008a). However, most studies did not find

2. HEALTH EFFECTS

Figure 2-33. Risk of Low Birth Weight Infant Relative to PFOA Levels (Presented as Adjusted Odds Ratios)

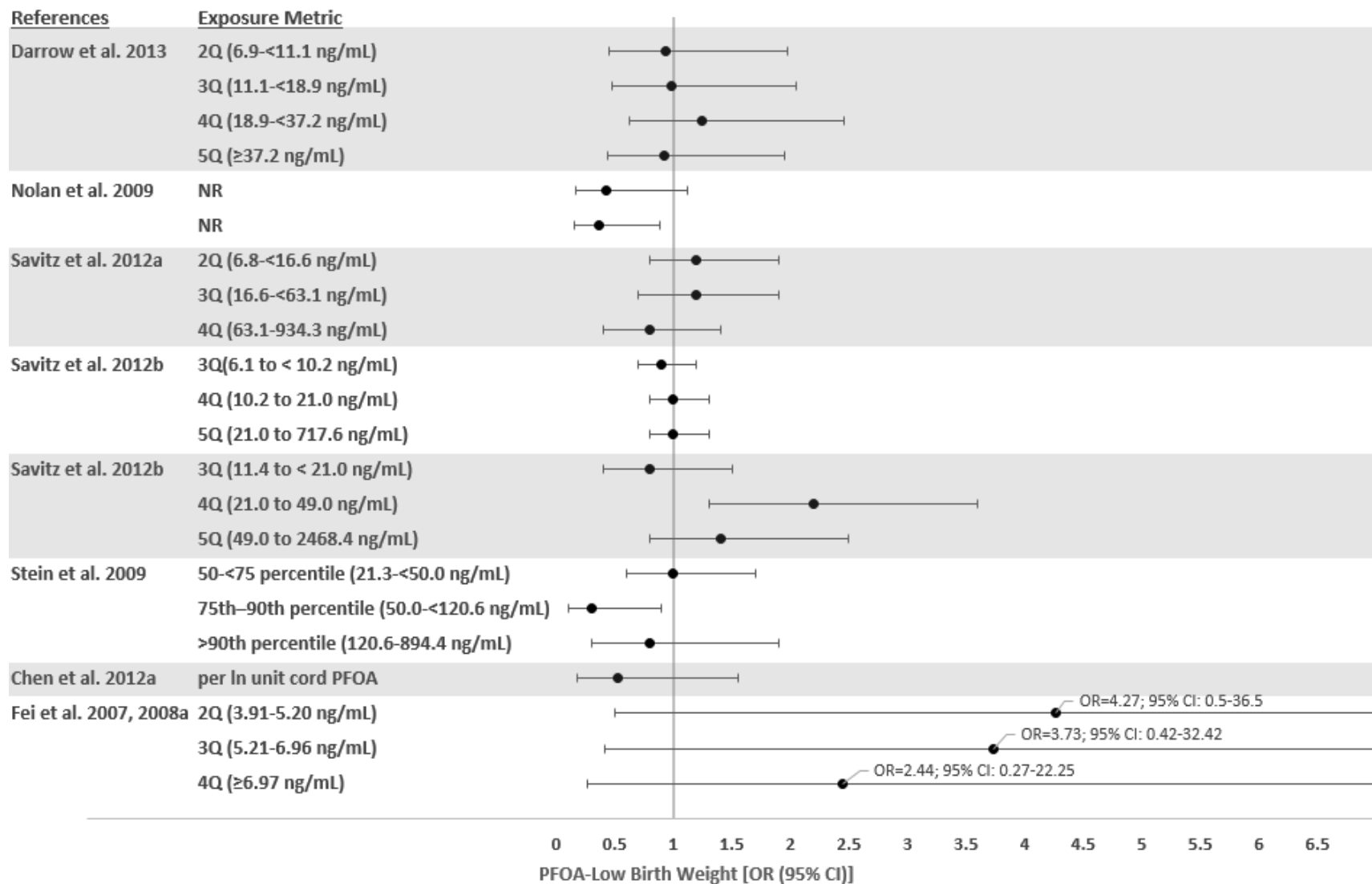

2. HEALTH EFFECTS

Figure 2-34. Risk of Small For Gestational Age Infant Relative to PFOA Levels (Presented as Adjusted Odds Ratios)

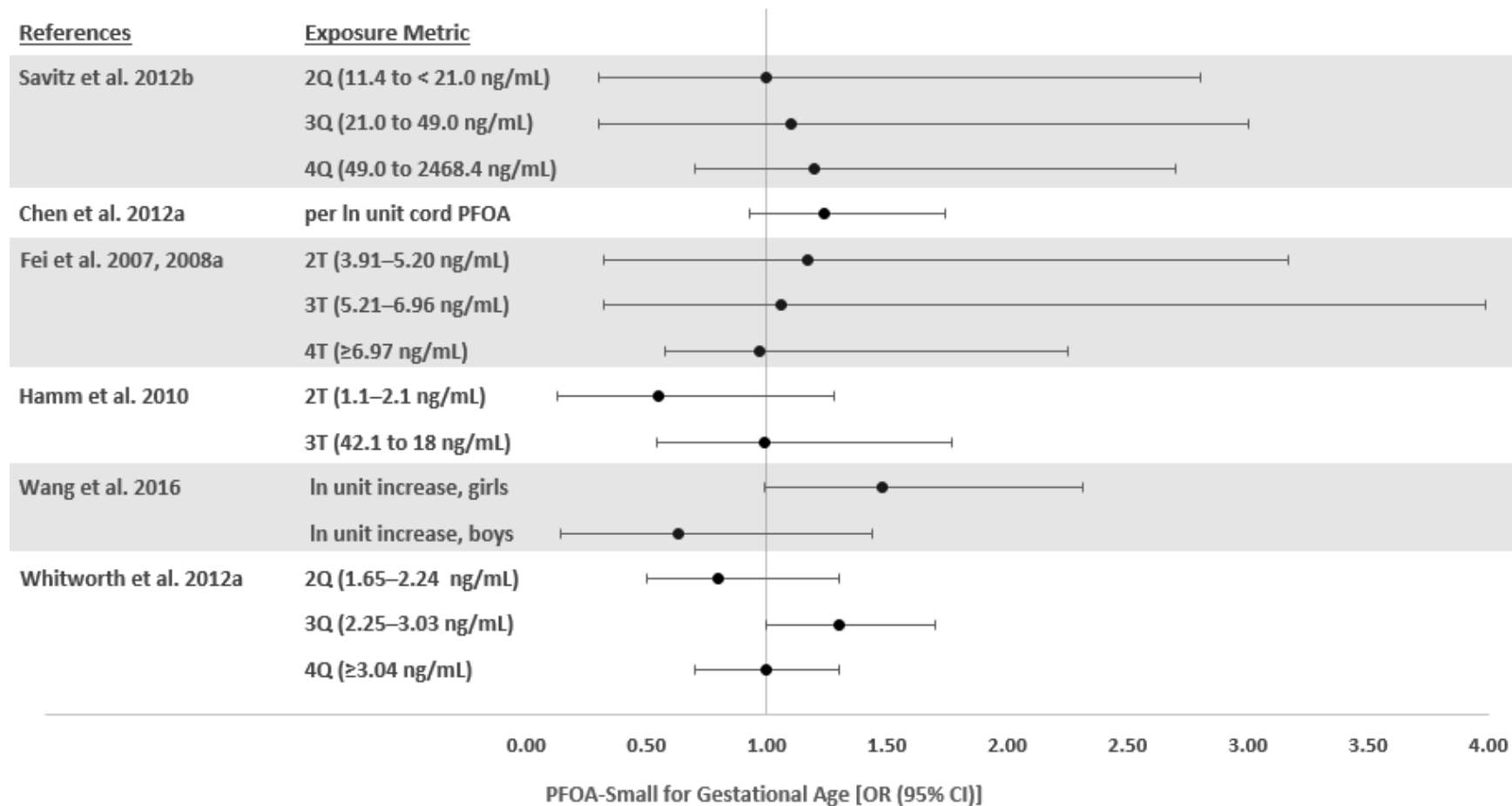

2. HEALTH EFFECTS

associations between maternal serum PFOA levels and birth length; head, chest, or abdominal circumference; or ponderal index (Bach et al. 2016; Chen et al. 2012a; Lee et al. 2013; Maisonet et al. 2012; Robledo et al. 2015a; Wang et al. 2016).

In a systematic review of 19 epidemiology studies discussed above, Johnson et al. (2014) evaluated the possible association between PFOA exposure and fetal growth and concluded that there was sufficient evidence that PFOA reduces fetal growth based on a moderate rating of the human evidence. A meta-analysis of the Apelberg et al. (2007b), Chen et al. (2012a), Fei et al. (2007, 2008a), Fromme et al. (2010), Hamm et al. 2009), Kim et al. (2011), and Maisonet et al. (2012) studies showed an association between PFOA and birth weight; a 1 ng/mL increase in serum or plasma PFOA was associated with a -18.9 g (95% CI -29.8 to -7.9) change in birth weight. A second meta-analysis (Verner et al. 2015) of the Apelberg et al. (2007b), Chen et al. (2012a), Fei et al. (2007), Hamm et al. (2010), Maisonet et al. (2012), Washino et al. (2009), and Whitworth et al. (2012a) studies found a similar result, a 1 ng/mL increase in PFOA levels was associated with a 14.72 g (95% CI -21.66 to -7.78) decrease in birth weight. Verner et al. (2015) also utilized a PBPK model to evaluate the influence of glomerular filtration rate on the association between maternal PFOA and birth weight. Utilizing simulated maternal PFOA levels at delivery, a 1 ng/mL increase in PFOA was associated with a 7.13 g (95% CI -8.46 to -5.80) decrease in birth weight; suggesting that glomerular filtration rate may be a confounding factor.

A small number of studies have examined the potential associations between PFOA exposure and risks of birth defects. In a study of C8 Health Study participants, no increases in the risk of brain, gastrointestinal, kidney, craniofacial, eye, limb, genitourinary, or heart defects were found (Stein et al. 2014c).

Epidemiology Studies—Neurodevelopmental Outcomes. A number of epidemiology studies have evaluated neurodevelopment at various ages using maternal serum PFOA or cord blood PFOA as a biometric of exposure. Fei et al. (2008b) did not find an increased risk of Apgar scores of <10 in newborns. Utilizing the Neonatal Intensive Care Unit Network Neurobehavioral Scale (NNNS) in 5-week-old infants, Donauer et al. (2015) found an increased risk of reduced muscle tone (hypotonia), which was associated with maternal serum PFOA levels, but found no associations on tests of social/easy going or high arousal/difficult. Goudarzi et al. (2016) reported lower scores on tests of mental and psychomotor development in female 6-month-old infants; no association was found when male and female infants were grouped together. When the infants were tested at 18 months of age, no association between maternal PFOA levels and mental and psychomotor indices were found. Fei et al. (2008b) did not find associations between maternal PFOA levels and the risk of delays in motor, cognitive, or

2. HEALTH EFFECTS

language development in 6- and 18-month-old infants. It is noted that in the Fei et al. (2008b) study, the mothers were asked to recall at what age the infants reached a developmental milestone, whereas standardized tests of development were used in the other two studies. Although the Donauer et al. (2015) and Goudarzi et al. (2016) studies suggest some delays in neurodevelopment in young infants, more research is needed before establishing a possible relationship with PFOA.

Studies in children have examined possible links between PFOA and IQ, motor skills, behavior, and ADHD. An association between estimated *in utero* PFOA levels and IQ was found in 6–12-year-old children participating in the C8 Health Studies (Stein et al. 2013); higher IQ scores were found in children with the highest estimated PFOA exposure levels. The study did not find an association with reading or math skills. A general population study (Wang et al. 2015b) did not find an association between maternal serum PFOA levels and IQ scores in children 5 or 8 years of age. In a study of adults (20 years of age), Strøm et al. (2014) did not find an association between maternal PFOA levels and scholastic achievement. A community study of children and adolescents did not find an association between serum PFOA levels and learning problems in 12–15 or 5–18 year olds (Stein and Savitz 2011). Two studies (Fei and Olsen 2011; Høyer et al. 2015a) did not find associations between maternal PFOA levels and motor coordination in 7 year olds or motor skills in 5–9 year olds.

Several studies have examined possible associations between maternal or child PFOA levels and scores on tests/surveys that assess behavioral problems. No associations between maternal PFOA levels and behavioral problems in 7 year olds (Fei and Olsen 2011) or behavioral regulation problems in 5 or 8 year olds (Vuong et al. 2016). Similarly, no associations between serum PFOA levels and performance on tasks requiring behavioral inhibition were observed in 9–11-year-old children (Gump et al. 2011). No associations between breast milk PFOA levels and behavioral development in 6- and 24-month-old infants were observed (Forns et al. 2015). In contrast, Høyer et al. (2015a) found an association between maternal PFOA levels and behavioral problems in 5–9-year-old children; the risk was increased in children with maternal PFOA levels in the 3rd tertile. Stein et al. (2014a) found an association between the children's serum PFOA levels and survey results on behavioral problems and emotional disturbances in girls aged 6–12 years of age; this association was not found in boys or in boys and girls combined. Additionally, the association was only found when the survey was completed by mothers, but not when completed by the child's teacher.

Ten studies have looked for a possible link between PFOA and ADHD in children. Two studies of participants of the C8 Health Study found lower scores on tests for ADHD (Stein et al. 2013) or lower

2. HEALTH EFFECTS

risks of ADHD (Stein and Savitz 2011) associated with estimated *in utero* PFOA or child PFOA levels, respectively. In a third community study in which parents and teachers completed surveys regarding ADHD-like behaviors (Stein et al. 2014a), no association between the child's serum PFOA (measured 3–4 years before the surveys were completed) and ADHD-like behaviors were found when the mothers completed the survey and an inverse association was found when the teachers completed the survey. Segregating the children by sex resulted in an association in girls (mother-completed survey only) and no associations in boys. Two general population studies have found associations between the risk of ADHD or increases in ADHD behavior in children. An increase in the risk of parent-reported ADHD diagnosis was observed in a study of 12–15-year-old NHANES participants (Hoffman et al. 2010). The second study (Høyer et al. 2015a) found increases in hyperactivity among 5–9-year-old children with maternal serum PFOA levels in the 3rd tertile. When this multinational cohort was segregated by country, the association was only found in group of children from Greenland, but not in the Ukrainian cohort. Median serum PFOA levels were slightly higher in the Greenland cohort; it is also noted that the median maternal PFOS levels were 4 times higher in the Greenland cohort than in the Ukraine cohort. Other general population studies have not found associations. Two case-control studies of children did not find increased risks of being diagnosed with ADHD associated with maternal PFOA levels (Liew et al. 2015) or cord blood PFOA levels (Ode et al. 2014). Two studies did not find associations between cord blood PFOA levels and performance on tests evaluating for ADHD symptoms in 7-year-old children (Lien et al. 2016) or 18-month-old infants (Quaak et al. 2016). A third study found no association between maternal PFOA levels and ADHD in 20 year olds (Strøm et al. 2014). In addition to looking at possible relationships between PFOA and ADHD, two studies did not find associations between maternal PFOA levels and autism behaviors (Braun et al. 2014) or the risk of autism diagnosis (Liew et al. 2015).

Epidemiology Studies—Development of the Reproductive System. Studies exploring possible links between PFOA and alterations in the development of the reproductive system have examined several outcomes including hormone levels in cord blood, hormone levels in children and adolescents, congenital malformations of reproductive organs, and age of puberty in boys and girls.

A multinational case-control general population study (Vesterholm Jensen et al. 2014) found a decrease in the risk of cryptorchidism in the Finnish cohort, but not in the Danish cohort or in the combined cohort. With the exception of inhibin levels, no associations between maternal serum PFOA levels and cord blood levels of reproductive hormones were found (Itoh et al. 2016). Cord inhibin was associated with maternal serum PFOA levels in male infants, but not in female infants (Itoh et al. 2016). Some alterations in reproductive hormone levels were found in 6–9-year-old boys and girls participating in the C8 Health

2. HEALTH EFFECTS

Study (Lopez-Espinosa et al. 2016). In boys, an inverse association between serum PFOA levels and total testosterone levels were observed; no associations were found for estradiol levels or insulin-like growth factor 1. In girls, an inverse association was found for insulin-like growth factor 1 levels and no associations were found for estradiol or testosterone levels. In adolescent girls, an association between maternal PFOA levels and testosterone levels was found (Maisonet et al. 2015a). This association was not found in young adult females (Kristensen et al. 2013). Other reproductive hormones were not shown to be associated with maternal PFOA levels (Kristensen et al. 2013; Maisonet et al. 2015a).

In a community exposure study (Lopez-Espinosa et al. 2011), increasing levels of serum PFOA were associated with delays in menarche in girls aged 8–18 years. Serum PFOA levels in the 2nd, 3rd, and 4th quartiles were associated with 142-, 163-, and 130-day delays in the onset of menarche, respectively. Using PBPK modeling, Wu et al. (2015) examined whether the association between serum PFOA and delays in the onset of menarche observed in the Lopez-Espinosa et al. (2011) study were due to reverse causality using a Monte Carlo PBPK model. They found that rapid growth around the time of menstruation onset may contribute to the apparent association between PFOA and delay of menarche. In the PBPK simulated study, the delay in the onset of menarche was 48 days for the 4th quartile (OR 0.82, 95% CI 0.76–0.88). A delay in menarche was also observed in a general population study; a 162-day delay was estimated in the daughters of women with maternal serum PFOA levels in the 3rd tertile (Kristensen et al. 2013). A second general population study did not find an association between maternal serum PFOA levels and an earlier age of menarche (Christensen et al. 2011).

The only study available on age of puberty in males (Lopez-Espinosa et al. 2011) did not find an association with serum PFOA levels.

Laboratory Animal Exposure Studies. Exposure of pregnant Sprague-Dawley rats to 25 mg/m³ APFO on GDs 6–15 resulted in a statistically significant reduction (10.3%) in neonatal body weight on PND 1, but the difference over controls was no longer significant on PND 4 (Staples et al. 1984). Exposure concentrations ≤ 10 mg/m³ did not affect neonatal body weight. The incidence of malformations and variations among the exposed groups and controls was comparable.

In utero exposure to PFOA resulted in prenatal losses and decreases in pup survival. An increase in resorptions was observed in mice administered ≥ 5 mg/kg/day throughout gestation (Lau et al. 2006) or 2 mg/kg/day on GDs 11–16 (Suh et al. 2011). Prenatal losses were also observed in PFOA mouse studies administering ≥ 6 mg/kg/day (Abbott et al. 2007), 5 mg/kg/day (White et al. 2011), or 20 mg/kg/day (Lau

2. HEALTH EFFECTS

et al. 2006) throughout gestation; an increase in the percentage of dams with total litter loss was also observed at 5 mg/kg/day (Wolf et al. 2007). Administration of 20 mg/kg/day PFOA on GDs 7–17 or 10–17 did not result in litter loss (Wolf et al. 2007); no effect on litter size was observed as a result of administration of 5 mg/kg/day on GDs 8–17 (White et al. 2009). Gestational exposure (GDs 1–17) to PFOA also resulted in perinatal losses in mice administered 3 mg/kg/day PFOA (Ngo et al. 2014) and decreases in pup survival in mice exposed to ≥ 0.6 mg/kg/day (Abbott et al. 2007), 3 mg/kg/day (Albrecht et al. 2013), or 5 mg/kg/day (Lau et al. 2006; Yahia et al. 2010; White et al. 2011, Wolf et al. 2007); 100% pup mortality was observed in the offspring of mice exposed to 10 mg/kg/day throughout gestation (Yahia et al. 2010). Decreased pup survival was also observed in mice exposed to 5 mg/kg/day PFOA on GDs 15–17 (Wolf et al. 2007). No alterations in fetuses/litter or survival were observed at 1 mg/kg/day PFOA (Lau et al. 2006; White et al. 2011). Butenhoff et al. (2004b) also reported increases in pup mortality on PNDs 6–8 in the offspring of rats administered 30 mg/kg/day PFOA throughout gestation and during lactation.

Decreases in birth weight have not been consistently found in mouse studies with PFOA. No significant alterations in birth weight were observed in mice exposed to 3 mg/kg/day (Albrecht et al. 2013), 5 or 10 mg/kg/day (Lau et al. 2006), or 20 mg/kg/day (Abbott et al. 2007); decreases in birth or fetal weight were observed at 5 mg/kg/day (Hines et al. 2009; Yahia et al. 2010), 10 mg/kg/day (Suh et al. 2011), and 20 mg/kg/day (Lau et al. 2006; Li et al. 2016). A decrease in mean litter weight on PNDs 2–14 was observed in mice administered ≥ 0.5 mg/kg/day PFOA on GDs 6–17 (Hu et al. 2010) and a decrease in pup body weight on PND 20 was observed in mice exposed to 5 mg/kg/day on GDs 8–17 or 12–17 (White et al. 2007). *In utero* exposure of mice to PFOA throughout gestation resulted in decreases in pup body weight in mice exposed to 1 mg/kg/day (Abbott et al. 2007; Hines et al. 2009), ≥ 3 mg/kg/day (Lau et al. 2006; Wolf et al. 2007), and 5 mg/kg/day (Yahia et al. 2010; White et al. 2007, 2011). In a cross-fostering study, lactation-only exposure (maternal dose of 5 mg/kg/day PFOA) resulted in decreased body weight in female pups on some PNDs (2, 3, 4, and 22, but not on PNDs 7, 10, 15, or 17) (Wolf et al. 2007). Hines et al. (2009) monitored body weights from birth to 18 months of age in female mice exposed *in utero* to PFOA on GDs 1–17. At weaning, decreases in body weight were observed at 1 and 5 mg/kg/day; by 10 weeks of age, there were no differences in body weight between the controls and mice exposed to ≥ 1 mg/kg/day. Significant increases in body weight were observed in mice exposed to 0.1 and 0.3 mg/kg/day, and by 20–29 weeks of age, the increases in body weight were observed in mice exposed to 0.01, 0.1, or 0.3 mg/kg/day. The largest increase in body weight gain (9.6%) was observed at 0.1 mg/kg/day; because the weight increase was less than 10%, the 0.1 mg/kg/day was considered a NOAEL. At 40 weeks of age, the increased body weight was observed in the 0.1 and 0.3 mg/kg/day

2. HEALTH EFFECTS

groups. At termination (18 months of age), there were no differences in body weight between the controls and mice exposed to 0.01–3 mg/kg/day; a decrease in body weight was observed at 5 mg/kg/day. During the period of increased body weight in the lower-dose animals, there were no changes in serum glucose levels or the response to a glucose challenge, but there were significant increases in insulin and leptin levels at 0.01 and 0.1 mg/kg/day. Although there were no changes in the percentage of body fat to body weight measurements in mice at 42 weeks of age, at 18 months of age, significant decreases in abdominal body fat and increases in intrascapular brown fat was observed at ≥ 1 mg/kg/day PFOA (Hines et al. 2009). Based on systematic review of pup body weight data from the Abbott et al. (2007), Hines et al. (2009), Lau et al. (2006), White et al. (2007, 2009, 2011), and Wolf et al. (2007) mouse studies, Koustas et al. (2014) concluded that there was sufficient evidence that exposure to PFOA adversely affected fetal growth in animals. A meta-analysis estimate was a decrease of 0.023 g pup body weight per 1 mg/kg/day increase in PFOA dose.

A few studies have examined the potential of PFOA to induce malformations/variations. Lau et al. (2006) reported reductions in ossification of the proximal phalanges at ≥ 1 mg/kg/day and supraoccipital at 10 or 20 mg/kg/day. This study also reported enlarged fontanels in pups exposed to ≥ 1 mg/kg/day and tail and limb defects at ≥ 5 mg/kg/day; however, there was no clear dose-response for these effects. Koskela et al. (2016) found altered femur and tibial bone morphology and decreased tibial mineral density in the offspring of mice exposed to 0.3 mg/kg/day in the diet on GDs 1–21. An increased percentage of litters with microcardia was also observed in the offspring of mice exposed to 10 or 20 mg/kg/day (Lau et al. 2006). No increases in the occurrence of malformations/variations were observed in the offspring of rats administered 100 mg/kg/day on GDs 6–15 (Staples et al. 1984) or in a 2-generation study at doses as high as 30 mg/kg/day (Butenhoff et al. 2004b).

Delayed eye opening was observed in the offspring of mice administered ≥ 1 mg/kg/day PFOA on GDs 1–17 (Abbott et al. 2007) and in mice administered 5 mg/kg/day throughout gestation (Lau et al. 2006; Wolf et al. 2007). Neither Albrecht et al. (2013) nor Lau et al. (2006) found alterations in eye opening in mice exposed to 3 mg/kg/day PFOA on GDs 1–17. Lau et al. (2006) also reported advanced preputial separation at ≥ 1 mg/kg/day and delayed vaginal opening at 20 mg/kg/day. The effect in the male offspring is in contrast to the Butenhoff et al. (2004b) study, which found delays in preputial separation in rats exposed to 30 mg/kg/day PFOA; a delay in vaginal patency was also observed at this dose.

A series of studies conducted by White and associates found significant delays in mammary gland development in the offspring of mice administered 1 mg/kg/day PFOA via gavage on GDs 8–17 (White et

2. HEALTH EFFECTS

al. 2011) or 5 mg/kg/day PFOA on GDs 1–17, 8–17, 12–17, 10–17, 13–17, or 15–17 (White et al. 2007, 2009, 2011). The delay was characterized as reduced ductal elongation and branching and delays in timing and density of terminal end buds and was observed at all observational periods (PNDs 10, 20, 22, and 42, and 63 and 18 months of age). Decreases in mammary epithelial growth, as assessed by developmental scoring, were observed in the offspring of mice exposed to 0.01 mg/kg/day on GDs 1–17 (Tucker et al. 2015), 0.3 mg/kg/day on GDs 1–17 (Macon et al. 2011), or 0.01 mg/kg/day on GDs 10–17 (Macon et al. 2011). Tucker et al. (2015) noted that the delays in mammary gland development began at puberty and continued during young adulthood. Albrecht et al. (2013) did not find any alterations in mammary gland development on PND 20 in mouse offspring following *in utero* exposure to PFOA on GDs 1–17. Delayed mammary gland development was also observed in offspring only exposed via lactation (maternal dose of 3 mg/kg/day PFOA on GDs 1–17); the effects were observed on PNDs 42 and 63, but not on PND 22 (White et al. 2009). In a multigeneration study conducted by White et al. (2011), delays in mammary gland development were not consistently observed in the F2 offspring of F1 females that were exposed *in utero* to 1 or 5 mg/kg/day PFOA. However, delays in mammary gland development were observed in the F1 and F2 offspring exposed to 0.001 mg/kg/day *in utero* (GDs 7–17) and postnatally. The investigators (White et al. 2011) noted that the delay in mammary gland development did not appear to affect lactational support based on normal survival and growth of the F2 pups. Tucker et al. (2015) noted dose-related strain differences on the effect of PFOA on mammary gland differences; effects were observed in CD-1 mice at ≥ 0.01 mg/kg/day and in C57BL/6 mice at ≥ 0.3 mg/kg/day (the highest NOAEL for this strain was 0.1 mg/kg/day); it is noted that the serum PFOA concentrations at a given dose were lower in the C57Bl/6 mice than in the CD-1 mice.

A consistent finding in the four mouse studies evaluating the neurodevelopmental toxicity of PFOA is an increase in motor activity. Increases in horizontal and ambulatory locomotor activity (tested on PND 60) were observed in the offspring of mice exposed to 0.1 mg/kg/day in the diet on GD 7 through PND 21 (Sobolewski et al. 2014); a decrease in resting time was also observed in the males. Significant increases in open field activity were observed at PND 36 in the offspring of mice exposed to 1.6 mg/kg/day throughout gestation and lactation (Cheng et al. 2013). Johansson et al. (2008) and Onishchenko et al. (2011) demonstrated a biphasic alteration in motor activity: an initial period of decreased activity followed by increased activity. Johansson et al. (2008) administered a single dose of 8.7 mg/kg/day PFOA to mice on PND 10 and monitored spontaneous activity for a 1-hour period when the mice were 2 or 4 months of age. In the first 20-minute period, there was a decrease in spontaneous activity, followed by a 20-minute period with an activity level similar to controls, and a 20-minute period with significantly increased spontaneous activity. Similarly, Onishchenko et al. (2011) reported an increase in activity in a

2. HEALTH EFFECTS

48-hour period in the adult offspring of mice exposed to 0.3 mg/kg/day PFOA throughout gestation; however, there was a decrease in activity during the initial 3 hours of testing. Johansson et al. (2008) also found an increased susceptibility of the cholinergic system in mice exposed to 0.58 or 8.7 mg/kg/day PFOA on PND 10. In control mice, an injection of nicotine resulted in increases in activity; mice exposed to 0.58 mg/kg/day also responded with an increase in activity, although the increase was less than that observed in the controls. In contrast, nicotine resulted in a decrease in activity in mice exposed to 8.7 mg/kg/day. Exposure to PFOA did not alter learning or memory, as evidenced by the lack of effect on maze tests (Cheng et al. 2013; Johansson et al. 2008). Tests of neurobehavioral development found altered motor coordination and impaired negative geotaxis reflex, but no effect on righting reflex or cliff avoidance, in the offspring of mice exposed to 1.6 mg/kg/day throughout gestation and lactation (Cheng et al. 2013). Decreases in initial novel object exploratory behavior were also observed at 0.1 mg/kg/day, but there were no alterations in recognition time for novel objects (Sobolewski et al. 2014).

Although not investigated in mammalian species, studies in chicken embryos and hatchlings demonstrate the developmental cardiotoxicity of PFOA (Jiang et al. 2012, 2013, 2016). The effects following *in ovo* exposure include thinning of the right ventricular wall in chick embryos and alterations in left ventricular posterior wall dimension, volume, heart rate, stroke volume, and ejection fraction in the hatchlings (Jiang et al. 2012). Tests with WY 14,643, a PPAR α agonist, and PFOA provide evidence that the cardiotoxicity involves both PPAR α and bone morphogenic protein 2 (BMP2) pathways (Jiang et al. 2013). Comparisons of results following *in ovo* exposure and *in vitro* exposure suggest that the cardiotoxicity was not likely due to cytotoxicity, but rather an alteration in early cardio morphology and function processes (Jiang et al. 2016).

Summary. Epidemiology studies have examined a number of potential developmental outcomes in communities living near a PFOA facility and in the general populations. Although not consistently reported, the available general population studies suggest an inverse association between maternal serum PFOA levels and birth weight; a number of studies have not found this association. Several systematic reviews of these data have concluded that there was sufficient evidence that maternal PFOA levels are associated with reductions in fetal growth. After correcting for glomerular filtration rate, a small decrease in birth weight was associated with increases in maternal serum PFOA. Two of the three studies evaluating possible effects of sexual maturation found small delays in the start of menarche associated with maternal serum PFOA levels. Overall, the data do not suggest associations between serum PFOA levels and adverse pregnancy outcomes such as miscarriages or stillbirths, most birth outcomes (e.g., risk of low birth weight, risk of small for gestational age, birth length, ponderal index, sex ratio, or birth

2. HEALTH EFFECTS

defects), or neurodevelopmental outcomes (IQ or scholastic achievement, motor skills, and risk of ADHD). Animal studies provide strong evidence that developmental toxicity is a sensitive target of PFOA toxicity. Observed effects include prenatal losses and decreases in pup survival, decreases in birth weight, developmental delays such as delayed eye opening, delays in mammary gland development, and increased motor activity.

PFOS

Epidemiology Studies—Pregnancy Outcomes. No associations between maternal PFOS levels and the risk of miscarriages were observed in several studies (Darrow et al. 2014; Jensen et al. 2015; Stein et al. 2009). Two studies reported increases in the risk of preterm birth associated with maternal serum PFOS levels in the >90th percentile (>23.2 ng/mL) (Stein et al. 2009) or cord blood PFOS levels in the 3rd and 4th quartiles (\geq 5.68 ng/mL) (Chen et al. 2012a), and one study reported a decrease risk in preterm birth (Whitworth et al. 2012a). Two other studies did not find associations for preterm birth (Fei et al. 2007, 2008a; Hamm et al. 2010).

Epidemiology Studies—Birth Outcomes. Occupational, community, and general population exposure studies have examined the possible links between maternal PFOS levels and a number of birth outcomes including birth weight; risk of low birth weight; risk of small for gestational age; birth length; head, chest, and abdominal circumferences; ponderal index; sex ratio; and birth defects. Most studies did not find associations between maternal serum PFOS levels and birth weight (Apelberg et al. 2007b; Ashley-Martin et al. 2016; Darrow et al. 2013; Bach et al. 2016; Fei et al. 2007, 2008a; Govarts et al. 2016; Hamm et al. 2010; Kim et al. 2011; Lee et al. 2013, 2016; Lenters et al. 2016a; Maisonet et al. 2012; Monroy et al. 2008; Robledo et al. 2015a; Whitworth et al. 2012a), including an occupational exposure study (Grice et al. 2007) in which female workers were exposed to very high levels of PFOS (serum levels ranged from 1,300 to 1,970 ng/mL). Three studies did find inverse associations between birth weight and maternal serum PFOS levels. In the Washino et al. (2009) study, an inverse association was found between maternal serum PFOS levels and birth weight; segregating by sex resulted in an inverse association in girls, but not in boys. The magnitude of the change was small, 148.8 g decrease in birth weight per log unit increase in maternal PFOS for combined. Maisonet et al. (2012) also reported small decreases in birth weight (140.1 g) in infants whose mother's serum PFOS levels were in the 3rd tertile. Similarly, Chen et al. (2012a) reported an inverse association between cord blood PFOS and birth weight, but the magnitude was small (110.2 g decrease per ln unit increase in cord PFOS levels). Although these studies found decreases in birth weight associated with PFOS levels, no studies found increases in the risk

2. HEALTH EFFECTS

of low birth weight infants (Chen et al. 2012a; Darrow et al. 2013; Fei et al. 2007, 2008a; Stein et al. 2009) or small for gestational age infants (Chen et al. 2012a; Fei et al. 2007, 2008a; Hamm et al. 2010; Whitworth et al. 2012a). The ORs for low birth weight and small for gestational age risks are presented in Figures 2-35 and 2-36. Maternal PFOS was not associated with birth length (Apelberg et al. 2007b; Bach et al. 2016; Chen et al. 2012a; Fei et al. 2007, 2008a; Lee et al. 2013; Robledo et al. 2015a; Washino et al. 2009) with the exception of the finding of a small decrease in birth length (-0.63 cm) that was associated with 3rd tertile maternal serum PFOS levels. Two studies reported inverse associations between ponderal index and cord blood PFOS levels (Apelberg et al. 2007b) and maternal serum PFOS levels (Lee et al. 2013); other studies did not find this effect (Chen et al. 2012a; Maisonet et al. 2012; Robledo et al. 2015a). Two studies reported small decreases in head circumference, which were associated with maternal serum PFOS levels (Apelberg et al. 2007b) and cord blood PFOS (Chen et al. 2012a); other studies have not found associations (Bach et al. 2016; de Cock et al. 2014; Fei et al. 2007, 2008a; Lee et al. 2013; Robledo et al. 2015a; Washino et al. 2009). Verner et al. (2015) conducted a meta-analysis of the Apelberg et al. (2007b), Chen et al. (2012a), Fei et al. (2007), Hamm et al. (2010), Maisonet et al. (2012), Washino et al. (2009), and Whitworth et al. (2012a) studies and found that a 1 ng/mL increase in maternal PFOS levels was associated with a 5.00 g (95% CI -8.92 to -1.09) decrease in birth weight. When the data were re-analyzed utilizing a PBPK model to account for glomerular filtration rate, the magnitude of the effect of PFOS on birth weight decreased (Verner et al. 2015). A 1 ng/mL increase in PFOS was associated with a 2.72 g (95% CI -3.40 to -2.04) decrease in birth weight.

One study reported no increases in the risk of birth defects associated with maternal serum PFOS levels (Stein et al. 2009); a second study found an increased risk of congenital cerebral palsy in girls, but not in boys (Liew et al. 2014). Bae et al. (2015) did not find associations between the odds of having a boy and paternal or maternal serum PFOS levels.

Epidemiology Studies—Neurodevelopmental Outcomes. Epidemiology studies examined several aspects of neurodevelopment, including age of reaching neurobehavioral milestones, IQ, motor development, behavior, ADHD, and autism. Fei et al. (2008b) did not find associations between maternal PFOS levels and the risk of having an Apgar score of <10 or in motor and mental development at 6 months. However, the study did find that some neurobehavioral milestones (delay in sitting, early use of word-like sounds, and delays in using two- word sentences) were associated with maternal PFOS levels. Goudarzi et al. (2016) did not find alterations on mental and psychomotor development in 6- and 18-month-old infants that were associated with maternal serum PFOS levels. A third study of infants did not find alterations in neurobehavioral or muscle coordination tests (Donauer et al. 2015).

2. HEALTH EFFECTS

Figure 2-35. Risk of Low Birth Weight Infant Relative to PFOS Levels (Presented as Adjusted Odds Ratios)

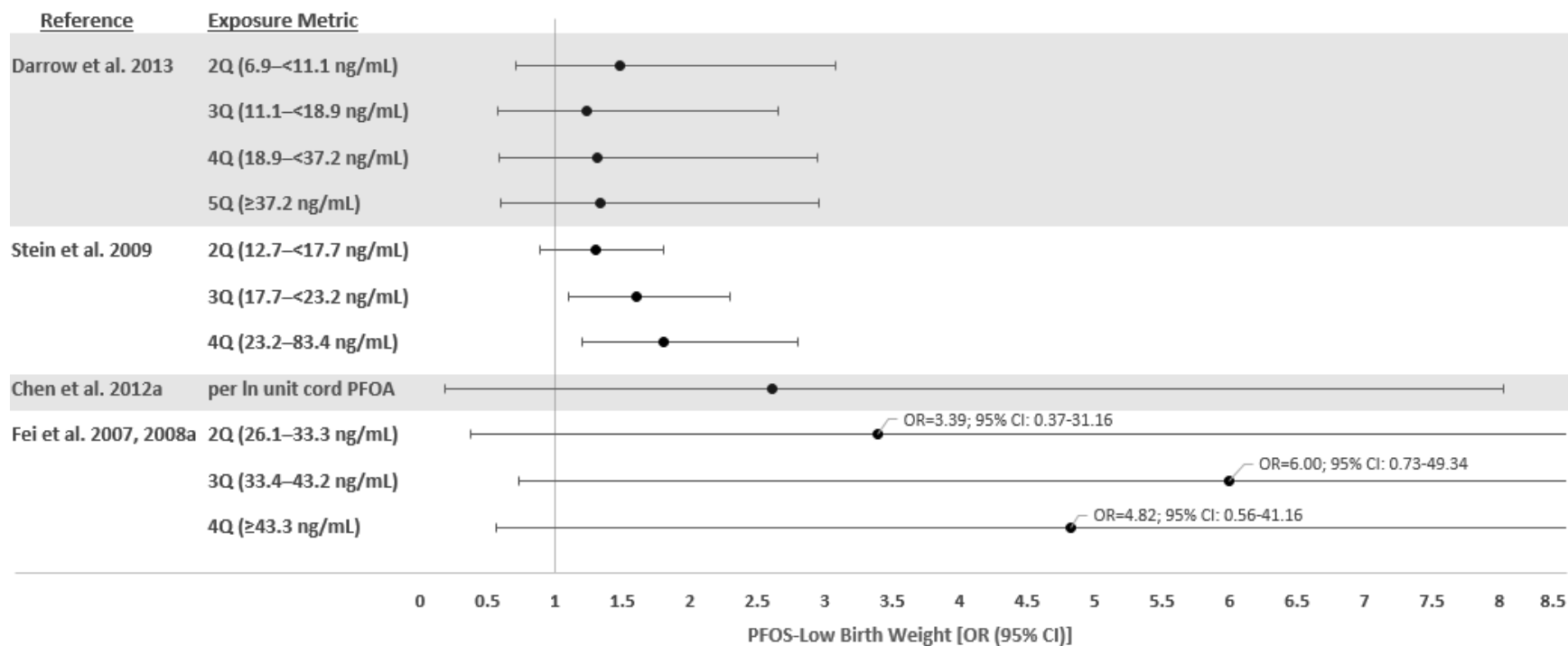

2. HEALTH EFFECTS

Figure 2-36. Risk of Small for Gestational Age Infant Relative to PFOS Levels (Presented as Adjusted Odds Ratios)

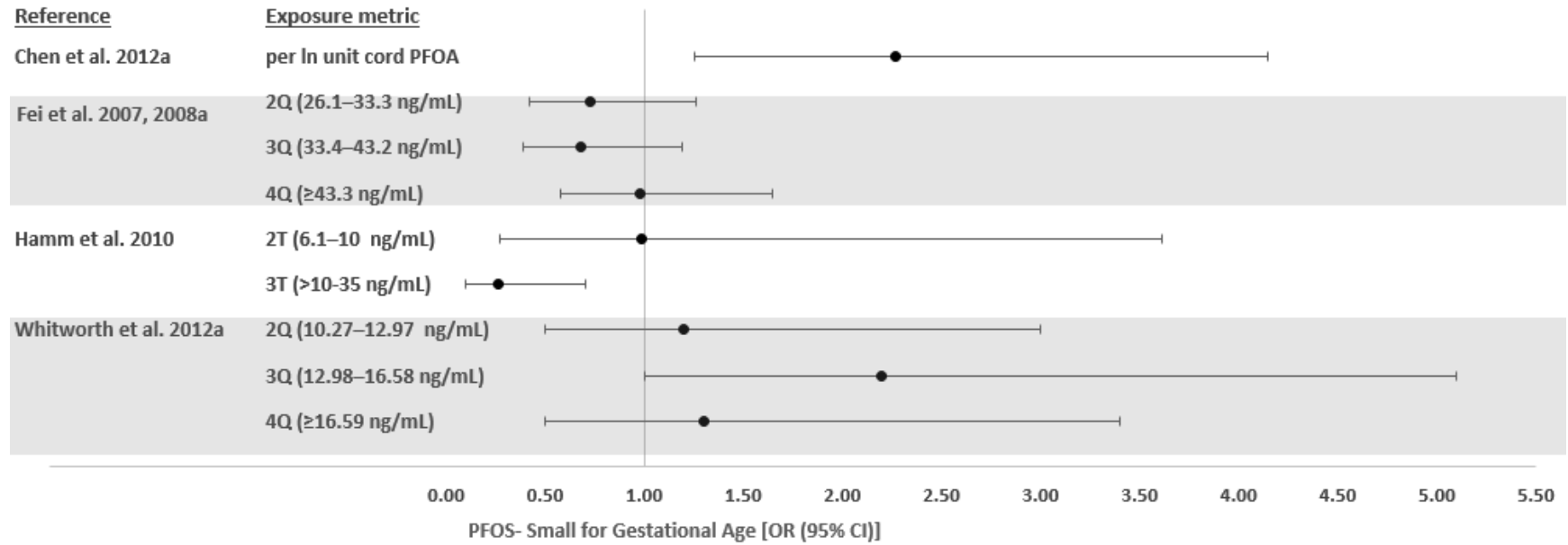

2. HEALTH EFFECTS

In the only study evaluating IQ, Wang et al. (2015b) did not find associations between maternal PFOS levels and IQ score in children 5 or 8 years of age. Strøm et al. (2014) found no associations between scholastic achievement in 20 year olds and maternal PFOS levels. In a study of children living in a community with high PFOA contamination, Stein and Savitz (2011) found decreases in the risk of learning problems in children 5–18 or 12–15 years of age. In contrast, Vuong et al. (2016) found increased risks of global executive functioning and metacognition problems that were associated with maternal PFOS levels. Three studies have not found links between maternal PFOS levels and behavioral health and motor coordination/skills in children (Fei and Olsen 2011; Høyner et al. 2015a) or between breast milk PFOS levels and behavioral development in 6- and 24-month-old infants (Forns et al. 2015). A third study (Vuong et al. 2016) found an increased risk for problems with behavioral regulation. The available data do not suggest an association between maternal PFOS levels or cord blood PFOS levels and the risk of ADHD or ADHD behaviors (Hoffman et al. 2010; Liew et al. 2015; Ode et al. 2014; Quaak et al. 2016; Stein and Savitz 2011; Strøm et al. 2014), although Liew et al. (2015) found a decreased risk of ADHD diagnosis in children whose mothers had serum PFOS levels in the 4th quartile. Similarly, Høyner et al. (2015a) did not find increases in the risk of hyperactivity in children and Gump et al. (2011) found a decrease in impulsivity. Braun et al. (2014) and Liew et al. (2015) did not find associations between maternal PFOS and autism risk.

Epidemiology Studies—Development of Reproductive System. Several epidemiology studies have examined the possible associations between PFOS and the development of the reproductive system, including the risk of congenital defects to reproductive organs, alterations in reproductive hormone levels, and age of puberty; the results of these studies are summarized in Table 2-25. No alterations in the risk of cryptorchidism (Toft et al. 2016; Vesterholm Jensen et al. 2014) or hypospadias (Toft et al. 2016) were found in two studies. Itoh et al. (2016) reported associations between maternal PFOS levels and alterations in cord blood hormone levels, in particular estradiol in males, testosterone:estradiol ratio in males (inverse association), progesterone levels in males and females, prolactin levels in females, and inhibin levels in males. Similarly, Toft et al. (2016) found associations between amniotic fluid PFOS levels and levels of testosterone, androstenedione, progesterone, and insulin-like factor 3 (inverse association) in amniotic fluid. Lopez-Espinosa et al. (2016) also found a number of alterations in reproductive hormone levels in 6–9-year-old boys and girls. In the boys, inverse associations between serum PFOS levels and estradiol, total testosterone, and insulin-like growth factor 1 were observed. Inverse associations between total testosterone and insulin-like growth factor 1 and serum PFOS levels were also observed in the girls. A study of young adult women found no associations between reproductive hormone levels and maternal PFOS levels (Kristensen et al. 2013).

2. HEALTH EFFECTS

A study of 8–18-year-old children found delays in the age of puberty in boys and girls (Lopez-Espinosa et al. 2011) that were associated with serum PFOS levels. In the children with serum PFOS levels in the 3rd and 4th quartiles, the respectively delays were 131 and 190 days in boys and 141 and 138 days in girls. In contrast, two other studies have not found alterations in either the age of menarche or an earlier age of menarche that were associated with maternal PFOS levels (Christensen et al. 2011; Kristensen et al. 2013). The differences in the biomarker of exposure and the potential exposure to high levels of PFOA in the Lopez-Espinosa et al. (2011) community study make it difficult to compare the results of these three studies. As discussed in the PFOA section, Wu et al. (2009) reanalyzed the Lopez-Espinosa et al. (2011) data using a Monte Carlo PBPK model, which accounted for rapid growth occurring around puberty, and found much shorter delays in the age of menarche than found in the Lopez-Espinosa et al. (2011) study. In the girls with simulated serum PPFOS levels in the 4th quartile, the delay was 72 days (OR 0.75, 95% CI 0.70–0.81).

Laboratory Animal Exposure Studies. Increases in fetal mortality and decreases in pup survival have also been observed in rats and mice exposed to PFOS *in utero* (Abbott et al. 2009; Chen et al. 2012b; Fuentes et al. 2006; Grasty et al. 2003, 2005; Lau et al. 2003; Lee et al. 2015a; Luebker et al. 2005a, 2005b; Ngo et al. 2014; Thibodeaux et al. 2003; Xia et al. 2011; Yahia et al. 2008). Increases in the number of resorptions and dead fetuses were observed in mice administered ≥ 0.5 mg/kg/day (Lee et al. 2015a); increases in abortions between GD 22 and 28 were observed in rabbits treated with 3.75 mg/kg/day PFOS by gavage on GDs 6–20 (Case et al. 2001). Decreases in the number of live fetuses were observed in mice exposed to ≥ 2.0 mg/kg/day on GDs 11–16 and 20 mg/kg/day on GDs 1–17 (Thibodeaux et al. 2003) or GDs 0–17 (Yahia et al. 2008). Increases in perinatal losses were observed in the litters of mice administered ≥ 0.1 mg/kg/day PFOS on GDs 1–17 (Ngo et al. 2014). Pup survival is affected at lower maternal doses. Significant decreases in pup survival were observed in rats at 1.6 mg/kg/day (dams were exposed for 6 weeks prior to mating and during gestation through lactation days 4 or 21) (Luebker et al. 2005a, 2005b) and in mice exposed to 4.5 mg/kg/day on GDs 15–18 (Abbott et al. 2009); no alterations in pup survival were observed in rats or mice exposed to 1 mg/kg/day (Luebker et al. 2005b; Yahia et al. 2008). A series of studies by Grasty et al. (2003) in rats that were exposed for 4 days during different gestational periods showed that the pup was more susceptible if exposure occurred later in gestation. On PND 4, pup survival was 70, 50, 60, 20, or 5% for exposures on GDs 2–5, 6–9, 10–13, 14–17, or 17–20, respectively. Grasty et al. (2003) and others (Abbott et al. 2009; Chen et al. 2012b; Lau et al. 2003) also noted that most deaths occurred within the first 4 PNDs, with the highest rates occurring on PND 1. Lau et al. (2003) and Luebker et al. (2005a) found that cross fostering did not

2. HEALTH EFFECTS

significantly improve pup survival; deaths were observed in the *in utero* only exposure group. However, Luebker et al. (2005a) showed that rats exposed *in utero* and during lactation had the highest pup mortality, as compared to other cross-fostered groups. The mechanism involved in the early pup mortality has not been identified, but there is some indication that pulmonary deficits may be a contributing factor. At high doses (50 mg/kg/day administered on GDs 19–20), pups demonstrated difficulty breathing within minutes of birth (Grasty et al. 2003). Histological examination of the lungs of pups exposed to 25 or 50 mg/kg/day on GDs 19–20 showed evidence of delayed lung maturation (Grasty et al. 2003, 2005), specifically, an increase in the proportion of solid lung tissue and a decrease in the proportion of small airway tissue. A comparison of the lungs of PFOS-exposed neonates to control fetuses (GD 21) showed that 17 and 50% of the lung tissue in the neonates exposed to 25 or 50 mg/kg/day, respectively, on GDs 19–20 was not histologically different from the control fetuses (Grasty et al. 2005). Administration of therapeutic agents known to enhance terminal lung maturation and accelerate surfactant production did not improve pup survival (Grasty et al. 2005). Histological damage has also been reported in pups exposed to lower PFOS levels. Lung atelectasis was observed in pups exposed to 10 mg/kg/day on GDs 0–18 (Yahia et al. 2008). No lung effects were observed in pups exposed to 1 mg/kg/day or in fetuses exposed to 20 mg/kg/day on GDs 0–17 (Yahia et al. 2008). Alveolar hemorrhage, thickened epithelial walls of the pulmonary alveolus, focal lung consolidation, and focal infiltration of inflammation cells were observed in pups exposed to 2 mg/kg/day on GDs 0–21; no lung effects were observed at 0.1 mg/kg/day (Chen et al. 2012b).

Decreases in fetal body weight, birth weight, and pup body weight have been observed in rats, mice, and rabbits exposed to PFOS (Case et al. 2001; Chen et al. 2012b; Era et al. 2009; Fuentes et al. 2006, 2007b; Grasty et al. 2003; Lau et al. 2003; Lee et al. 2015a; Luebker et al. 2005a, 2005b; Rogers et al. 2014; Xia et al. 2011; Yahia et al. 2008). In rats, the lowest-adverse-effect level for decrease in fetal body weight was 10 mg/kg/day following administration on GDs 2–20 (Thibodeaux et al. 2003) and the highest no-effect level was 5 mg/kg/day, also identified in the Thibodeaux et al. (2003) study. Decreases in rat pup birth weight and body weight on PND 4 were observed in the offspring of rats exposed to 0.4 mg/kg/day for 42 days prior to mating and gestation through lactation day 4 (Luebker et al. 2005b). Mice appear to be less sensitive to the effect of PFOS on pup body weight than rats (Lau et al. 2003). Exposure of rats to 2 mg/kg/day PFOS on GDs 2–21 resulted in significant decreases in birth weight and pup body weight on PNDs 1–3; exposure to 5 mg/kg/day resulted in decreases in pup body weight through PND 19. In contrast, no alterations in birth weight or pup body weight were observed in mice exposed to doses as high as 5 mg/kg/day on GDs 1–18. Fuentes et al. (2007b) reported the lowest LOAEL of 6 mg/kg/day for decreases in pup weight in mice exposed on GDs 12–18. Decreases in fetal body weight were observed

2. HEALTH EFFECTS

in mice exposed to 10 mg/kg/day on GDs 0–17 (Yahia et al. 2008). Fuentes et al. (2006) did not find decreases in fetal body weight following exposure to 6 mg/kg/day on GDs 6–18. In rabbits, a decrease in fetal body weight was observed following exposure to 2.5 mg/kg/day on GDs 6–20, but not at 1 mg/kg/day (Case et al. 2001).

Several studies also reported delays in developmental milestones. Delays in eye opening were observed in rats exposed to 2 mg/kg/day on GDs 2–21 (Lau et al. 2003) or 0.4 mg/kg/day for 42 days prior to mating and throughout the gestation and lactation periods (Luebker et al. 2005a) and in mice exposed to 8.5 mg/kg/day on GDs 15–18 (Abbott et al. 2009). Fuentes et al. (2007b) did not find a delay in eye opening in mouse pups exposed to 6 mg/kg/day on GDs 12–18, but did find a delay in pinna detachment at this dose level. A decrease in neuromuscular development, as evidenced by a delay in tail pull reflex, climbing ability, and forelimb grip strength, was observed in mice exposed to 6 mg/kg/day on GDs 12–18 (Fuentes et al. 2007b).

Prenatal exposure to PFOS has resulted in malformations/anomalies/variations in rats, mice, and rabbits (Case et al. 2001; Era et al. 2009; Thibodeaux et al. 2003; Yahia et al. 2008). An increased incidence of cleft palate was observed in rats exposed to 10 mg/kg/day on GDs 2–20 (Thibodeaux et al. 2003) and in mice exposed to 10 mg/kg/day on GDs 0–17 (Yahia et al. 2008), 15 mg/kg/day on GDs 1–17 (Thibodeaux et al. 2003), 20 mg/kg/day on GDs 1–17 (Era et al. 2009), and 50 mg/kg/day on GDs 11–15 (Era et al. 2009). Other skeletal and external alterations included sternal defects in rats exposed to 10 mg/kg/day on GDs 2–20 (Thibodeaux et al. 2003) and mice exposed to 1 mg/kg/day on GDs 0–17 (Yahia et al. 2008), delayed skeletal ossification in rabbits exposed to 2.5 mg/kg/day on GDs 6–20 (Case et al. 2001), wavy ribs and spina bifida occulta in mice exposed to 10 mg/kg/day on GDs 1–17 (Yahia et al. 2008), and tail abnormalities and delayed ossification of phalanges at 20 mg/kg/day (Yahia et al. 2008). Visceral abnormalities, consisting of enlarged right atrium at 10 mg/kg/day, and ventricular septal defects at 20 mg/kg/day were observed in mice exposed on GDs 1–17 (Thibodeaux et al. 2003). No malformations/anomalies/variations were found by Thibodeaux et al. (2003) in mice exposed to 1 mg/kg/day on GDs 1–17 or by Fuentes et al. (2006) in mice exposed to 6 mg/kg/day on GDs 6–18. In addition to the previously discussed histological alterations observed in the pups exposed to lethal doses, mild to severe intracranial dilatation of blood vessels was observed in fetuses exposed to 20 mg/kg/day on GDs 0–17 and in pups exposed to 10 mg/kg/day on GDs 0–18 (Yahia et al. 2008). No histological alterations were observed in the heart of rat pups exposed to 2 mg/kg/day on GDs 2–21 (Xia et al. 2011); the study also found no alterations in heart rate or blood pressure. Lee et al. (2015b) found increases in

2. HEALTH EFFECTS

cholesterol levels in fetal livers of mice exposed to PFOA on GDs 1–17 and Wan et al. (2014b) found increases in relative liver weights in pups on PND 21.

Neurodevelopmental studies have shown that prenatal and/or postnatal exposure to PFOS can affect motor activity, but does not appear to affect learning or memory. A significant decrease in locomotion was observed in male mice aged 5–8 weeks exposed to 0.3 mg/kg/day on GDs 1–17 when they were placed in a novel environment (Onishchenko et al. 2011). Hallgren et al. (2015) reported biphasic alterations in spontaneous activity in 2-month-old mice administered a single dose of 11.3 mg/kg on PND 10; locomotor activity was reduced during the first 20-minute period, was unchanged in the second period, and increased during the third period. Decreases in circadian activity were noted in males and increases in the number of inactive periods were noted in males and females when they were observed over a 48-hour period. The study also found increased inactivity in an elevated plus maze test. In an open field test of 70-day-old mice exposed to 6 mg/kg/day on GDs 12–18, an increase in the amount of time spent in the center of the field was found; no changes in vertical movement were found (Ribes et al. 2010). In 3-month-old mice exposed to 6 mg/kg/day on GDs 12–18, a decrease in the distance traveled was observed after 20–25 minutes in an open field apparatus; activity was not affected during the first 5 minutes of the test (Fuentes et al. 2007a). In a 15-minute open field test, prenatal exposure to 6 mg/kg/day PFOS on GDs 12–18 did not alter motor activity in 3-month-old mice (Fuentes et al. 2007b). In contrast, Butenhoff et al. (2009b) found a significant increase in locomotion in male rats exposed to 0.3 or 1.0 mg/kg/day PFOS throughout gestation and lactation. However, this effect was only observed in male rats on PND 17; no significant alterations were observed on PNDs 13, 21, or 61. An increase in locomotion was observed in female rats on PND 21 exposed to 1.0 mg/kg/day, but not at other time points. To evaluate the biological relevance of the increased activity, activity was analyzed by 1-minute sequential time periods. The investigators concluded that the increased activity observed in the 0.3 mg/kg/day males at PND 17 and 1.0 mg/kg/day females at PND 21 was not treatment-related due to the lack of significant changes in total or ambulatory activity and the similarity in habituation pattern between the treated groups and controls. In the 1.0 mg/kg/day PND 17 males, the pattern of habituation differed from controls and there was an increase in ambulatory activity; this increase in locomotor activity was considered to be related to PFOS exposure. The increased activity was observed in the last three time periods. Postnatal exposure (PND 10) to 11.3 mg/kg/day resulted in an initial decrease in motor activity followed by an increase in activity in 2- and 4-month-old mice (Johansson et al. 2008). In 2-month-old mice exposed to 0.75 mg/kg/day, there was a decrease in total activity during the first 20 minutes of testing, but not during the remaining 40 minutes of the test; no changes in activity were observed in the 4-month-old mice exposed to 0.75 mg/kg/day. Johansson et al. (2009) also found an altered response to

2. HEALTH EFFECTS

nicotine exposure. Exposure to 11.3 mg/kg/day PFOS resulted in a decrease in motor activity in response to nicotine exposure, as compared to the increased activity observed in controls; no significant alteration was observed at 0.75 mg/kg/day. Two studies testing muscle coordination did not find alterations in the offspring of rats exposed to 3.2 mg/kg/day for 6 weeks prior to mating and throughout gestation and lactation (Luebker et al. 2005a) or mice exposed to 6 mg/kg/day on GDs 12–18 (Fuentes et al. 2007b). A decrease in muscle coordination was observed in mice exposed to 0.3 mg/kg/day on GDs 1–17 (Onishchenko et al. 2011). Perinatal exposure to PFOS did not significantly alter learning or memory in rats exposed to 2 mg/kg/day on GDs 2–21 and tested on PND 21 (Lau et al. 2003), the offspring of rats exposed to 3.2 mg/kg/day for 6 weeks prior to mating and throughout gestation and lactation and tested on PNDs 21 and 70 (Luebker et al. 2005a), or mice exposed to 6 mg/kg/day on GDs 12–18 and tested at 3 months of age (Fuentes et al. 2007a). In contrast, decreases in spatial learning ability were observed in the offspring of mice exposed to 0.8 mg/kg/day on GD 1 through PND 1 or on PNDs 1–7 (Wang et al. 2015b).

The effect of pre- and/or postnatal exposure to PFOS on serum lipid levels, thyroid function, and immune function has also been evaluated by a small number of studies. In the offspring of rats exposed to 1.6 mg/kg/day for 6 weeks prior to mating through GD 20, a significant decrease in fetal serum cholesterol levels and an increase in LDL cholesterol levels were observed (Luebker et al. 2005b). In rats exposed through PND 4, there was a decrease in serum triglyceride levels in the pups exposed to 1 mg/kg/day (Luebker et al. 2005b). No alterations in thyroid histology or follicular morphology were observed in rats exposed to 1 mg/kg/day on GD 0–PND 20 (Chang et al. 2009), and no alterations in TSH levels were observed in the Chang et al. (2009) study or in rats exposed to 2 mg/kg/day on GDs 2–21 (Lau et al. 2003). Decreases in total and free T4 levels were observed in rats exposed to 1 mg/kg/day on GDs 2–21 (Lau et al. 2003); free T4 levels remained low through PND 35. Similarly, a cross-fostering study found decreases in T4 levels in rats exposed to 3.2 mg/kg/day *in utero*, during lactation only, and throughout gestation and lactation (Yu et al. 2009b). Altered immune function was observed in mice exposed to PFOS on GDs 1–17 (Keil et al. 2008). At 5 mg/kg/day, an altered IgM antibody response to sRBCs was observed in 8-week-old males; decreases in CD3+ and CD4+ lymphocytes were also observed. At 1 mg/kg/day, there was decreased NK cell activity in males; no effects were observed at 0.1 mg/kg/day.

Summary. A number of epidemiology studies have evaluated developmental outcomes in occupational, community (living near a PFOA facility), and general exposure populations. Overall, these studies have not found associations between serum PFOS and adverse pregnancy outcomes (miscarriage, preterm

2. HEALTH EFFECTS

birth), most birth outcomes (risks of low birth weight or small for gestational age, birth length, head, chest or abdominal circumferences, ponderal index, sex ratio, or birth defects), or neurodevelopmental outcomes (IQ, motor development, behavior, ADHD, or autism). It is noted that some studies have found associations for these effects and for some effects, only a couple of studies examined the endpoint. Although most studies did not find associations between maternal PFOS and birth weight, a meta-analysis did find a small decrease in birth weight was associated with increasing maternal PFOS levels, after adjustment for glomerular filtration rate. There is also some suggestive evidence that PFOS levels may be associated with small delays in the age of puberty in boys and girls. Studies in laboratory animals clearly indicate that developmental toxicity is a sensitive outcome of PFOS exposure. Oral exposure studies have reported increases in fetal mortality and decreases in pup survival; decreases in fetal body weight, birth weight, and pup body weight; delays in developmental milestones such as eye opening; increases in skeletal malformations/anomalies/variations such as cleft palate and delayed skeletal ossification; and decreases in offspring motor activity.

PFHxS

Epidemiology Studies—Pregnancy Outcomes. Two studies, summarized in Table 2-22 have evaluated possible links between pregnancy outcomes and maternal PFHxS levels. Jensen et al. (2015) did not find an association between maternal PFHxS levels and the risk of miscarriage. Hamm et al. (2010) found a decreased risk of preterm births among women with serum PFHxS levels in the 3rd tertile.

Epidemiology Studies—Birth Outcomes. General population studies have evaluated possible associations between maternal PFHxS levels and birth outcomes including birth weight, length, small for gestation age, and birth defects; studies are summarized in Table 2-23. Bach et al. (2016) and Maisonet et al. (2012) reported inverse associations between maternal PFHxS levels and birth weight; however, other studies have not found associations (Hamm et al. 2010; Kim et al. 2011; Lee et al. 2013, 2016; Lenters et al. 2016a; Monroy et al. 2008). The risk of low birth weight infants was not examined in the available epidemiology studies; Hamm et al. (2010) did not find an association between maternal PFHxS level and the relative risk of small for gestational age. Several studies did not find associations between maternal PFHxS levels and birth length, head circumference, or ponderal index (Bach et al. 2016; Lee et al. 2013). Maisonet et al. (2012) found an inverse association for birth length, but no association for ponderal index. Only one study examined possible birth defects; Liew et al. (2014) did not find an association between maternal PFHxS levels and the risk of congenital cerebral palsy in a case-control study.

2. HEALTH EFFECTS

Epidemiology Studies—Neurodevelopmental Outcomes. Epidemiology studies, summarized in Table 2-24, have examined PFHxS-related alterations in risks of ADHD, autism, IQ, and behavior. Wang et al. (2015b) did not find associations between maternal PFHxS levels and IQ in 5- or 8-year-old children. However, Vuong et al. (2016) found a higher risk of performing poorly on tests of global executive function with increasing maternal PFHxS levels. No association between serum PFHxS levels and the risk of learning problems was found in children living in a community with high PFOA levels (Stein and Savitz 2011). Gump et al. (2011) found an inverse association between serum PFHxS levels and performance on tasks requiring behavioral inhibition; Vuong et al. (2016) did not find alterations in behavioral regulation. Two studies evaluated the risk of ADHD and reported conflicting findings. Stein and Savitz (2011) reported increases in risk of ADHD in 5–18 and 12–15 year olds with serum PFHxS levels in the 2nd, 3rd, or 4th quartile, whereas Liew et al. (2015) reported an inverse association between maternal PFHxS levels and risk of ADHD. This study also did not find an increase in the risk of autism; Braun et al. (2014) also found no association between maternal PFHxS levels and performance on tests assessing autism.

Epidemiology Studies—Development of the Reproductive System. No associations between reproductive hormone levels and serum PFHxS levels (Lopez-Espinosa et al. 2016) or maternal serum PFHxS levels (Maisonet et al. 2015a) were found in boys and girls 6–9 years of age or in girls 15 years of age. Christensen et al. (2011) did not find an association between maternal PFHxS levels and risk of an earlier menarche. Summaries of these epidemiology studies are presented in Table 2-25.

Laboratory Animal Studies. Administration of 9.2 mg/kg/day PFHxS on PND 10 resulted in a decrease in spontaneous motor activity during the first 20 minutes of the test and an increase in activity in the last 20 minutes of the test (Viberg et al. 2013). The study also assessed the influence of PFHxS on nicotine-induced behavior. In the 9.2 mg/kg/day PFHxS group, exposure to nicotine did not significantly affect spontaneous motor activity, which was in contrast to the nicotine-induced increases in spontaneous motor activity observed in the controls and lower PFHxS groups. Another study evaluating the developmental toxicity of PFHxS did not find alterations in litter size, pup survival, or pup body weight in rats exposed to 10 mg/kg/day PFHxS for 14 days prior to mating and throughout gestation and lactation (Butenhoff et al. 2009a; Hoberman and York 2003).

2. HEALTH EFFECTS

PFNA

Epidemiology Studies—Pregnancy Outcomes. Two studies (summarized in Table 2-22) have examined pregnancy outcome. Jensen et al. (2015) found an increase in the risk of having a miscarriage before gestation week 12, which was associated with maternal serum PFNA levels. No alterations in the risk of preterm birth was found in a study conducted by Chen et al. (2012a).

Epidemiology Studies—Birth Outcomes. Several studies have examined the possible link between birth outcomes and maternal PFNA levels, these studies are summarized in Table 2-23. Most studies did not find an association between birth weight and maternal PFNA levels (Bach et al. 2016; Chen et al. 2012a; Lee et al. 2016; Lenters et al. 2016a; Monroy et al. 2008; Robledo et al. 2015a). No alterations in the risk of low birth weight or small for gestational age were found in a study conducted by Chen et al. (2012a). Wang et al. (2016) did find an inverse association between maternal PFNA levels and birth weight in girls only. Chen et al. (2012a) found an association between maternal PFNA levels and birth length, but other studies have not found alterations (Bach et al. 2016; Robledo et al. 2015a; Wang et al. 2016). Most studies did not find alterations in ponderal index or head circumference (Bach et al. 2016; Chen et al. 2012a; Robledo et al. 2015a; Wang et al. 2016); Chen et al. (2012a) reported an inverse association between cord PFNA levels on ponderal index. No associations between maternal PFNA or paternal PFNA levels and the odds of a male birth were observed in a general population study (Bae et al. 2015). Liew et al. (2014) did not find alterations in the risk of congenital cerebral palsy that were associated with maternal PFNA levels.

Epidemiology Studies—Neurodevelopmental Outcomes. Several potential neurodevelopmental outcomes have been examined in epidemiology studies; these studies are summarized in Table 2-24. No association between maternal PFNA levels and full-scale IQ scores were observed in 8-year-old children (Wang et al. 2015b); however, an association was found for visual IQ. Maternal PFNA levels were not associated with IQ scores in 5 year olds (Wang et al. 2015b). Stein and Savitz (2011) found a decrease in the risk of learning problems in 5–18 or 12–15 year olds with serum PFNA levels in the two highest quartiles or in the 4th quartile, respectively. Vuong et al. (2016) did not find an association between maternal PFNA levels and metacognition or global executive functioning in 5 or 8 year olds. Mixed results have been found in studies on behavior. Gump et al. (2011) found a decrease in behavioral response inhibition that was associated with serum PFNA levels in children aged 9–11 years, and Lien et al. (2016) reported inverse associations between cord blood PFNA levels in inattention and hyperactivity/inattention in 7-year-old children, but no effect on hyperactivity/impulsivity. Vuong et al. (2016) did not

2. HEALTH EFFECTS

find an association between maternal PFNA levels and behavior regulation. Three studies have not found associations between PFNA levels and ADHD risk (Hoffman et al. 2010; Liew et al. 2015; Stein and Savitz 2011). Similarly, maternal PFNA levels do not appear to be associated with autism (Braun et al. 2014; Liew et al. 2015).

Epidemiology Studies—Development of the Reproductive System. An inverse association between PFNA levels and insulin-like growth factor 1 was found in boys and girls aged 6–9 years (Lopez-Espinosa et al. 2016). No associations were found between PFNA and estradiol or total testosterone in 6–9 years olds (Lopez-Espinosa et al. 2016) or between maternal PFNA and testosterone or sex hormone binding globulin levels in 15-year-old girls (Maisonet et al. 2015a). Additionally, no association between maternal serum PFHxS levels and risk of earlier age of menarche were observed in girls (Christensen et al. 2011). Summaries of these three studies are presented in Table 2-25.

Laboratory Animal Studies. Three studies were identified that examined the developmental toxicity of PFNA in laboratory animals. Full litter resorptions were observed in mice administered 10 mg/kg/day on GDs 1–17; maternal weight loss was also observed at this dose level (Das et al. 2015). At ≤ 1.5 mg/kg/day, decreases in postnatal survival were observed (Das et al. 2015; Wolf et al. 2010). Decreases in birth weight were observed in female offspring of rats administered 5 mg/kg/day PFNA on GDs 1–20 (Rogers et al. 2014) and in male offspring of mice administered ≥ 3 mg/kg/day PFNA on GDs 1–17 (Das et al. 2015). No skeletal or visceral abnormalities were observed in mouse pups (Das et al. 2015). Reductions in nephron endowment (number of functioning nephrons at birth) were observed in male rat pups on PND 22 (Rogers et al. 2014). This study also found increases in systolic blood pressure in pups at 10 weeks of age; no alterations were observed at 26 or 52 weeks of age. Delays in eye opening and decreased in pup body weight gain were observed in offspring of mice administered 2.0 mg/kg/day on GDs 1–18 (Wolf et al. 2010). Studies in PPAR α knockout mice did not find alterations in pup survival, birth weight, pup body weight gain, or day of eye opening at maternal doses as high as 2.0 mg/kg/day (Wolf et al. 2010). Comparison between the results in tests using wild-type mice and knockout mice suggests that PPAR α plays a role in PFNA developmental toxicity (Wolf et al. 2010).

PFDeA

Epidemiology Studies—Pregnancy Outcomes. In the only identified epidemiology study examining pregnancy outcomes, Jensen et al. (2015) found an increased risk of miscarriage that was associated with maternal PFDeA levels.

2. HEALTH EFFECTS

Epidemiology Studies—Birth Outcomes. A small number of epidemiology studies examined risks of adverse birth outcomes associated with maternal PFDeA exposure; these studies are summarized in Table 2-23. Wang et al. (2016) found an inverse association between maternal PFDeA levels and birth weight in female infants only. This study also found an increased risk for small for gestational age among female infants. Other studies have not found associations (Bach et al. 2016; Lee et al. 2016; Lenters et al. 2016a; Robledo et al. 2015a). Epidemiology studies have not found associations between birth length, ponderal index, and/or head circumference and maternal PFDeA levels (Bach et al. 2016; Robledo et al. 2015a; Wang et al. 2016). Liew et al. (2014) did not find alterations in the risk of congenital cerebral palsy in boys or girls and Bae et al. (2015) did not find alterations in odds of a male birth associated with maternal or paternal PFDeA levels. Additionally, Kim et al. (2016b) did not find associations between serum PFDeA levels and thyroid parameters.

Epidemiology Studies—Neurodevelopmental Outcomes. Several studies have evaluated the potential of PFDeA to adversely affect neurodevelopment; see Table 2-24 for a summary of the studies. Wang et al. (2015b) did not find associations between maternal PFDeA levels and IQ in 5- and 8-year-old children. Similarly, Vuong et al. (2016) did not find alterations in scores on tests of global executive functioning and metacognition in 5- or 8-year-old children. This study also found no alteration in behavioral regulation. In contrast, Gump et al. (2011) found increases in impulsivity. Liew et al. (2015) found decreases in the risk of ADHD and autism in children.

Laboratory Animal Studies. An increase in fetal mortality was observed in mice exposed to 12.8 mg/kg/day PFDeA on GDs 6–15 (Harris and Birnbaum 1989); this dose level was also associated with a marked decrease in fetal weight/litter (50% lower than controls), 100% incidence of variations in ossification of the braincase, decreases in maternal body weight, and maternal mortality. Decreases in fetal body weight/litter were observed at ≥ 1 mg/kg/day. The study did not find alterations in the occurrence of cleft palate, soft tissue malformations, or skeletal malformations. In mice exposed to 10.8 mg/kg/day PFDeA on PND 10, there was no effect on spontaneous activity, habituation, performance on an elevated maze test, or response to a nicotine injection (Johansson et al. 2008). These results differ from the Johansson et al. (2008) findings when mice were exposed to PFOA or PFOS and the findings of Viberg et al. (2013) in mice exposed to PFHxS.

2. HEALTH EFFECTS

PFUA

Epidemiology Studies—Pregnancy Outcomes. Limited epidemiology studies evaluated pregnancy outcomes. Jensen et al. (2015) did not find an alteration in the risk of miscarriage before gestation week 12.

Epidemiology Studies—Birth Outcomes. The results from a study conducted by Wang et al. (2016) found an inverse association between maternal PFUA levels and birth weight and an increased risk of small for gestation age among female infants. The remaining epidemiology studies have not found alterations in infant size (birth weight, birth length, ponderal index, head circumference) (Bach et al. 2016; Chen et al. 2012a; Lee et al. 2016; Lenters et al. 2016a) or the risks of low birth weight (Chen et al. 2012a) or small for gestational age (Chen et al. 2012a). No association between serum PFUA levels and thyroid parameters were observed in infants (Kim et al. 2016a). The results of the epidemiology studies examining associations between birth outcome and PFUA are presented in Table 2-23.

Epidemiology Studies—Neurodevelopmental Outcomes. The results of two studies examining possible associations between neurodevelopmental outcome and PFUA are summarized in Table 2-24. Wang et al. (2015b) found no association between maternal PFUA levels and IQ score in 5 and 8 year olds; the study did find an inverse association with scores on tests assessing performance IQ. Lien et al. (2016) found no associations between cord blood PFUA levels and performance on behavioral tests.

Laboratory Animal Studies. One study was identified that examined the potential developmental toxicity of PFUA (Takahashi et al. 2014); the study found decreases in pup body weight at birth and on PND 4 in the offspring of rats administered via gavage 1.0 mg/kg/day PFUA.

PFBuS

Laboratory Animal Studies. No alterations in pup survival, body weight, or development were observed at doses as high as 1,000 mg/kg/day in a 2-generation rat study of potassium PFBuS (Lieder et al. 2009b).

2. HEALTH EFFECTS

PFBA

Epidemiology Studies—Birth Outcomes. In the only available epidemiology studies examining birth outcomes, no associations were found between serum PFBA levels and thyroid parameters in infants (Kim et al. 2016a).

Laboratory Animal Studies. A delay (approximately 1 day) in eye opening was observed in the offspring of mice administered via gavage 35 mg/kg/day PFBA on GDs 1–17 (Das et al. 2008).

PFDoA

Epidemiology Studies—Birth Outcomes. General population studies conducted by Lee et al. (2016) and Lenters et al. (2016a) did not find associations between cord blood PFDoA or maternal PFDoA levels and birth weight. Wang et al. (2016) found an inverse association between maternal PFDoA levels and birth weight and head circumference in female infants; no alteration in the risk of small for gestation age was found. The results of these three studies are summarized in Table 2-23.

Epidemiology Studies—Neurodevelopmental Outcomes. As summarized in Table 2-24, only one study examined neurodevelopmental outcomes. In this study, maternal PFDoA levels were not associated with IQ scores in 5- or 8-year-old children (Wang et al. 2015b).

PFOSA

Epidemiology Studies. Robledo et al. (2015a) found an inverse association between maternal PFOSA levels and birth weight in boys, but not in girls; paternal PFOSA levels were not associated with birth weight. The study did not find alterations in birth length, head circumference, or ponderal index (see Table 2-23). Bae et al. (2015) did not find alterations in the odds of a male birth that was associated with maternal or paternal PFOSA levels. As summarized in Table 2-24, only one study evaluated possible associations between PFOSA and neurodevelopmental outcomes. Gump et al. (2011) reported an inverse association between serum PFOSA levels and performance on tasks requiring behavioral inhibition. In the only study examining development of the reproductive system, Christensen et al. (2011) did not find an association between maternal serum PFOSA levels and the risk of an earlier age of menarche in girls (see Table 2-25).

2. HEALTH EFFECTS

Me-PFOSA-AcOH

Epidemiology Studies. Bae et al. (2015) found decreased odds of a female birth that was associated with paternal Me-PFOSA-AcOH levels; there were no alterations in the odds of male births associated with maternal or paternal Me-PFOSA-AcOH levels. Robledo et al. (2015a) found no associations between maternal or paternal Me-PFOSA-AcOH levels and birth weight, birth length, head circumference, or ponderal index. The results of these studies are presented in Table 2-23. Christensen et al. (2011) did not find an association between maternal Me-PFOSA-AcOH levels and an earlier age of menarche; the results of the study are summarized in Table 2-25.

Et-PFOSA-AcOH

Epidemiology Studies. Two epidemiology studies (summarized in Table 2-23) evaluated birth outcomes. No associations were found between paternal or maternal Et-PFOSA-AcOH levels and the odds of male birth (Bae et al. 2015) or birth weight, birth length, head circumference, or ponderal index (Robledo et al. (2015a). An earlier age of menarche was not associated with maternal Et-PFOSA-AcOH levels were found in a study conducted by Christensen et al. (2011).

2.18 OTHER NONCANCER

Overview. A number of epidemiology studies have examined the possible associations between perfluoroalkyls and outcomes related to diabetes; the results of these studies are summarized in Table 2-26, with additional study details presented in the *Supporting Document for Epidemiological Studies for Perfluoroalkyls*, Table 14. Overall, the epidemiology studies do not provide support for an association between serum perfluoroalkyl levels and increases in the risk of diabetes or related outcomes (e.g., increases in blood glucose, glucose tolerance) for PFOA, PFOS, PFHxS, PFNA, PFDeA, PFUA, PFHpA, or PFOSA. Additionally, results of studies on PFOA, PFOS, PFHxS, and Me-PFOSA-AcOH do not suggest a link between perfluoroalkyls and gestational diabetes. Only one laboratory animal study examined other noncancer endpoints (Table 2-5).

2. HEALTH EFFECTS

Table 2-26. Summary of Outcomes Related to Diabetes in Humans^a

Reference and study population ^b	Serum perfluoroalkyl level	Outcome evaluated	Result ^c
PFOA			
Leonard 2006 Occupational (n=6,027)	>250–≤750 ng/mL PFOA	Diabetes deaths	SMR 183 (112–283)* (males only)
Leonard et al. 2008 Occupational (n=6,027)	NR	Diabetes deaths	SMR 197 (123–298)*
Lundin et al. 2009 Occupational (n=3,992)	Probable exposure	Diabetes deaths	SMR 2.0 (1.2–3.2)*
Raleigh et al. 2014 Occupational (n=9,027)	NR	Diabetes deaths	SMR 0.76 (0.50–1.11)
Steenland et al. 2015 Occupational (n=3,713)	Cumulative	Risk of diabetes	RR 1.10 (0.77–1.57) no lag RR 1.12 (0.76–1.66) 10-year lag
Steenland and Woskie 2012 Occupational (n=1,088)	580 ng/mL (median PFOA)	Diabetes deaths	SMR 1.90 (1.35–2.61)* no lag SMR 1.90 (0.98–3.33) 10-year lag SMR 1.73 (0.83–3.18) 20-year lag
Anderson-Mahoney et al. 2008 Community (n=566)	NR	Self-reported diabetes	SPR 1.54 (1.16–2.05)*
Karnes et al. 2014 Community (n=32,254 C8 participants)	Cumulative	Self-reported diabetes	HR 1.00 (0.99–1.00, p=0.60), retrospective analysis HR 1.00 (1.00–1.01, p=0.31), prospective analysis
		Fasting blood glucose	NS (p>0.05)
MacNeil et al. 2009 Community (n=13,922 C8 participants)	122.7 ng/mL (mean PFOA)	Validated diabetes	OR 0.72 (0.52–1.00) (10 th decile)

2. HEALTH EFFECTS

Table 2-26. Summary of Outcomes Related to Diabetes in Humans^a

Reference and study population ^b	Serum perfluoroalkyl level	Outcome evaluated	Result ^c
Fisher et al. 2013 General population (n=2,700)	2.46 ng/mL (geometric mean PFOA)	Insulin	NS (p=0.12)
		Blood glucose	NS (p=0.17)
		HOMA-IR	NS (p=0.10)
Lin et al. 2009 General population (NHANES) (n=474 adolescents); General population (NHANES) (n=969 adults)	1.51 ng/mL (mean log PFOA)	Insulin	NS (p>0.05)
		β-cell function	NS (p>0.05)
		Fasting blood glucose	NS (p>0.05)
		HOMA-IR	NS (p>0.05)
	1.48 ng/mL (mean log PFOA)	Insulin	Association (p<0.05)
β-cell function		Association (p<0.05)	
Fasting blood glucose		NS (p>0.05)	
HOMA-IR		NS (p>0.05)	
Lind et al. 2014 General population (n=1,016)	3.3 ng/mL (median PFOA)	Diabetes	OR 0.97 (0.61–1.53, p=0.88)
		HOMA-IR	NS (p=0.20)
Melzer et al. 2010 General population (NHANES) (n=3,966)	10.39 ng/mL (M) 9.47 ng/mL (F) (4 th PFOA quartile)	Self-reported diabetes	OR 0.69 (0.41–1.16, p=0.158)
Nelson et al. 2010 General population (NHANES) (n=306 adolescent and 524 adults)	4.6 ng/mL (mean PFOA)	HOMA (adolescent)	NS (p=0.16) (M), NS (p=0.11) (F)
		HOMA (adult)	NS (p>0.05)
Shapiro et al. 2016 General population (1,274 pregnant women)	1.68 ng/mL (geometric mean PFOA)	Gestational diabetes	NS (p=0.86 for trend)
		Impaired glucose tolerance	NS (p=0.36 for trend)
Su et al. 2016 General population (n=571)	5.8–8.0 ng/mL (2 nd PFOA quartile)	Diabetes	OR 0.39 (0.16–0.96)* (inverse association)
		Fasting blood glucose	Inverse association (p<0.01 for trend)*
		Glucose tolerance	Inverse association (p<0.01 for trend)*

2. HEALTH EFFECTS

Table 2-26. Summary of Outcomes Related to Diabetes in Humans^a

Reference and study population ^b	Serum perfluoroalkyl level	Outcome evaluated	Result ^c
		Glycated hemoglobin	Inverse association (p=0.04 for trend)*
Zhang et al. 2015a General population (n=258)	3.07 and 3.94 ng/mL (geometric mean PFOA in women with or without gestational diabetes)	Gestational diabetes	OR 1.86 (1.14–3.02)*
PFOS			
Fisher et al. 2013 General population (n=2,700)	8.04 ng/mL (geometric mean PFOS)	Insulin	NS (p=0.88)
		Blood glucose	NS (p=0.96)
		HOMA-IR	NS (p=0.25)
Lin et al. 2009 General population (NHANES) (n=474 adolescents)	3.11 ng/mL (log mean PFOS)	Insulin	NS (p>0.05)
		HOMA-IR	NS (p>0.05)
		β-cell function	NS (p>0.05)
		Blood glucose	NS (p>0.05)
General population (NHANES) (969 adults)	3.19 ng/mL (log mean PFOS)	Insulin	Association (p<0.05)*
		HOMA-IR	Association (p<0.05)*
		β-cell function	Association (p<0.05)*
		Blood glucose	NS (p>0.05)
Lind et al. 2014 General population (n=1,016)	13.2 ng/mL (median PFOS)	Diabetes	OR 1.43 (0.94–22.16, p=0.09)
		HOMA	NS (p=0.51)
Melzer et al. 2010 General population (NHANES) (n=3,966)	57.73 ng/mL (M) 50.96 ng/mL (F) (4 th quartile mean PFOS)	Self-reported diabetes	OR 0.87 (0.57–1.31, p=0.491)
Nelson et al. 2010 General population (NHANES) (n=306 adolescent and 524 adults)	25.3 ng/mL (mean PFOS)	HOMA (adolescent)	NS (p=0.18) (M), NS (p=0.22) (F)
		HOMA (adult)	NS (p>0.05)
Shapiro et al. 2016 General population (1,274 pregnant women)	4.58 ng/mL (geometric mean PFOS)	Gestational diabetes	NS (p=0.70 for trend)
		Impaired glucose tolerance	NS (p=0.74 for trend)

2. HEALTH EFFECTS

Table 2-26. Summary of Outcomes Related to Diabetes in Humans^a

Reference and study population ^b	Serum perfluoroalkyl level	Outcome evaluated	Result ^c
Su et al. 2016 General population (n=571)	>4.8 ng/mL (4 th PFOS quartile)	Diabetes	OR 3.37 (1.18–9.65)*
		Fasting blood glucose	Association (p<0.01 for trend)*
		Glucose tolerance test	Association (p≤0.01 for trend)*
		Glycated hemoglobin	Association (p=0.04 for trend)*
Zhang et al. 2015a General population (n=258)	13.10 and 12.04 ng/mL (geometric mean PFOS in women with or without gestational diabetes)	Gestational diabetes	OR 1.13 (0.75–1.72)
PFHxS			
Fisher et al. 2013 General population (n=2,700)	2.18 ng/mL (geometric mean PFHxS)	Insulin	NS (p=0.89)
		Blood glucose	NS (p=0.98)
		HOMA-IR	NS (p=0.20)
Lin et al. 2009 General population (NHANES) (n=474 adolescents); General population (NHANES) (n=969 adults)	0.95 ng/mL (log mean)	Insulin	NS (p>0.05)
		HOMA-IR	NS (p>0.05)
		B-cell function	NS (p>0.05)
		Blood glucose	NS (p>0.05)
	0.60 ng/mL (log mean PFHxS)	Insulin	NS (p>0.05)
		HOMA-IR	NS (p>0.05)
		B-cell function	NS (p>0.05)
		Blood glucose	NS (p>0.05)
Lind et al. 2014 General population (n=1,016)	2.1 ng/mL (median PFHxS)	Diabetes	OR 1.00 (0.74–1.35, p=0.98)
		HOMA	NS (p=0.29)
Nelson et al. 2010 General population (NHANES) (n=306 adolescent and 524 adults)	2.6 ng/mL (mean PFHxS)	HOMA (adolescent)	NS (p=0.20) (M), Inverse association (p=0.001)* (F)
		HOMA (adult)	NS (p>0.05)
Shapiro et al. 2016 General population (n=1,274 pregnant women)	1.02 ng/mL (geometric mean PFHxS)	Gestational diabetes	NS (p=0.73 for trend)
		Impaired glucose tolerance	NS (p=0.44 for trend)

2. HEALTH EFFECTS

Table 2-26. Summary of Outcomes Related to Diabetes in Humans^a

Reference and study population ^b	Serum perfluoroalkyl level	Outcome evaluated	Result ^c
PFNA			
Lin et al. 2009 General population (NHANES) (n=474 adolescents)	0.35 ng/mL (log mean PFNA)	Insulin	Inverse association (p<0.05)*
		HOMA-IR	NS (p>0.05)
		β-cell function	Inverse association (p<0.05)*
		Blood glucose	NS (p>0.05)
General population (NHANES) (n=969 adults)	0.21 ng/mL (log mean PFNA)	Insulin	NS (p>0.05)
		HOMA-IR	NS (p>0.05)
		β-cell function	NS (p>0.05)
		Blood glucose	NS (p>0.05)
Lind et al. 2014 General population (n=1,016)	0.7 ng/mL (median PFNA)	Diabetes	OR 1.30 (0.85–1.97, p=0.22)
		HOMA	NS (p=0.90)
Nelson et al. 2010 General population (NHANES) (n=306 adolescent and 524 adults)	1.3 ng/mL (mean PFNA)	HOMA (adolescent)	NS (p=0.83) (M), (p=0.20) (F)
		HOMA (adult)	NS (p>0.05)
Su et al. 2016 General population (n=571)	>5.1 ng/mL (4 th PFNA quartile)	Diabetes	OR 0.31 (0.11–0.88)* 4th quartile (inverse association)
		Fasting blood glucose	NS (p=0.10 for trend)
		Glucose tolerance test	Inverse association (p<0.01 for trend)*
		Glycated hemoglobin	NS (p=0.11 for trend)
Zhang et al. 2015a General population (n=258)	1.23 and 1.20 ng/mL (geometric mean) PFNA in women with or without gestational diabetes)	Gestational diabetes	OR 1.06 (0.70–1.60)

2. HEALTH EFFECTS

Table 2-26. Summary of Outcomes Related to Diabetes in Humans^a

Reference and study population ^b	Serum perfluoroalkyl level	Outcome evaluated	Result ^c
PFDeA			
Zhang et al. 2015a General population (n=258)	0.41 and 0.40 ng/mL (geometric mean PFDeA in women with or without gestational diabetes)	Gestational diabetes	OR 1.04 (0.70–1.53)
PFUA			
Lind et al. 2014 General population (n=1,016)	0.3 ng/mL (median PFUA)	Diabetes HOMA	OR 0.95 (0.59–1.52; p=0.81) NS (p=0.32)
Su et al. 2016 General population (n=571)	6.4–9.2 ng/mL (3 rd PFUA quartile)	Diabetes Fasting blood glucose Glucose tolerance test Glycated hemoglobin	OR 0.24 (0.08–0.78)* 3rd quartile (inverse association) Inverse association (p<0.01 for trend)* Inverse association (p<0.01 for trend)* NS (p=0.17 for trend)
PFHpA			
Lind et al. 2014 General population (n=571)	0.05 ng/mL (median PFHpA)	Diabetes HOMA	OR 1.02 (0.77–1.34, p=0.90) NS (p=0.56)
PFOSA			
Lind et al. 2014 General population (n=571)	0.11 ng/mL (median PFOSA)	Diabetes HOMA	OR 1.07 (0.75–1.53, p=0.71) NS (p=0.070)

2. HEALTH EFFECTS

Table 2-26. Summary of Outcomes Related to Diabetes in Humans^a

Reference and study population ^b	Serum perfluoroalkyl level	Outcome evaluated	Result ^c
Me-PFOSA-AcOH			
Zhang et al. 2015a	0.30 and 0.29 ng/mL ng/mL (geometric mean Me-PFOSA- AcOH in women with or without gestational diabetes)	Gestational diabetes	OR 1.05 (0.71–1.54)
General population (n=258)			

^aSee the *Supporting Document for Epidemiological Studies for Perfluoroalkyls*, Table 14 for more detailed descriptions of studies.

^bParticipants in occupational exposure may have also lived near the site and received residential exposure; community exposure studies involved subjects living near PFOA facilities with known exposure to high levels of PFOA.

^cAsterisk indicates association with perfluoroalkyl compound; unless otherwise specified, values in parenthesis are 95% confidence intervals.

(F) = females; HOMA = homeostatic model assessment; HR = hazard ratio; IR = insulin resistance; (M) = males; Me-PFOSA-AcOH = 2-(N-methyl-perfluorooctane sulfonamide) acetic acid; NHANES = National Health and Nutrition Examination Survey; NR = not reported; NS = not significant; OR = odds ratio; PFDeA = perfluorodecanoic acid; PFHpA = perfluoroheptanoic acid; PFHxS = perfluorohexane sulfonic acid; PFNA = perfluorononanoic acid; PFOA = perfluorooctanoic acid; PFOS = perfluorooctane sulfonic acid; PFOSA = perfluorooctane sulfonamide; PFUA = perfluoroundecanoic acid; SMR = standardized mortality ratio; SPR = standardized prevalence ratio

2. HEALTH EFFECTS

1 **PFOA**

2
3 *Epidemiology Studies.* A cohort mortality study conducted by Leonard et al. (2008; Leonard 2006) of
4 workers at the Washington Works facility found a significant increase in deaths from diabetes, as
5 compared to workers at other DuPont facilities in the region. In an update of the Leonard et al. (2008)
6 study, Steenland and Woskie (2012) found an increased risk of diabetes deaths when compared to other
7 regional DuPont employees, but not when compared to the U.S. population. However, when the workers
8 were categorized by estimated cumulative exposure levels, the exposure-response trend was not
9 statistically significant. Lundin et al. (2009) also found an increase in deaths from diabetes in workers
10 exposed to APFO at the 3M Cottage Grove facility in Minnesota, as compared to Minnesota death rates.
11 The increase was only found in workers with probable exposure to APFO, but not with definite exposure;
12 no deaths from diabetes were observed in the workers with definite exposure to APFO. As noted by
13 Steenland and Woskie (2012), diabetes mortality may not be a good surrogate for the underlying diabetes
14 incidence data. Raleigh et al. (2014) did not find an increase in diabetes deaths at the Cottage Grove
15 facility and Steenland et al. (2015) did not find an increased risk of diabetes associated with cumulative
16 PFOA exposure at the Washington Works facility.

17
18 In community exposure studies, Anderson-Mahoney et al. (2008) found an increased prevalence of self-
19 reported diabetes in residents living near the Washington Works facility, as compared to expected rates
20 taken from NHANES. In contrast, Karnes et al. (2014) did not find an increased risk of self-reported
21 diabetes associated with cumulative PFOA levels and MacNeil et al. (2009) did not find an increased risk
22 of validated diabetes in C8 Health Study participants. General population studies found either an inverse
23 association between serum PFOA and risk of diabetes (Su et al. 2016) or no association (Lind et al. 2014;
24 Melzer et al. 2010). Additionally, general population studies have not found associations between serum
25 PFOA levels and insulin (Fisher et al. 2013; Lin et al. 2009), blood glucose levels (Fisher et al. 2013; Lin
26 et al. 2009; Su et al. 2016), homeostatic model assessment for insulin resistance (HOMA-IR) (Fisher et al.
27 2013; Lin et al. 2009; Lind et al. 2014; Nelson et al. 2010), or glucose tolerance (Su et al. 2016). Two
28 studies evaluated the risk of gestational diabetes and found mixed results. In a case-control study, Zhang
29 et al. (2015a) found an increased risk of gestational diabetes associated with serum PFOA, whereas
30 Shapiro et al. (2016) did not find associations between serum PFOA and gestational diabetes or impaired
31 glucose tolerance. The ORs for the risk of diabetes and gestational diabetes are graphically presented in
32 Figure 2-37.

2. HEALTH EFFECTS

Figure 2-37. Diabetes Risk Relative to Serum PFOA Levels (Presented as Adjusted Ratios)

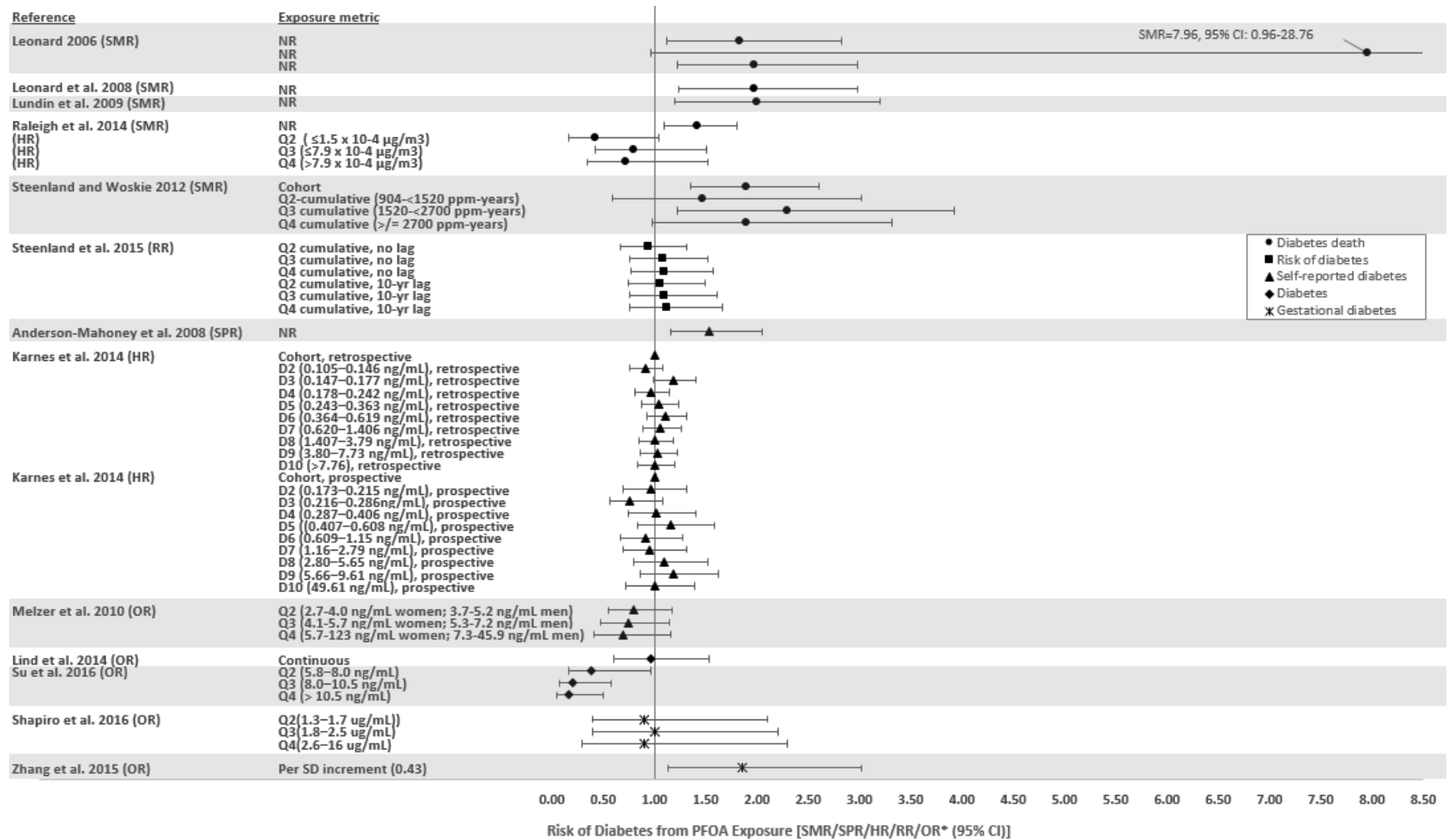

2. HEALTH EFFECTS

PFOS

Epidemiology Studies. In a general population study conducted by Su et al. (2016), an increased risk of diabetes was noted, as well as associations between serum PFOS levels and fasting blood glucose, response to glucose tolerance test, and glycated hemoglobin levels. Two other general population studies did not find increased risks of diabetes (Lind et al. 2014; Melzer et al. 2010). Several studies have not found associations between serum PFOS levels and insulin, blood glucose, or HOMA-IR levels (Fisher et al. 2013; Lin et al. 2009; Lind et al. 2014; Nelson et al. 2010). Lin et al. (2009) found associations between serum PFOS and insulin and HOMA-IR in a study of NHANES adult participants; these associations were not found in adolescent participants. No alterations in the risk of gestational diabetes were observed in two general population studies (Shapiro et al. 2016; Zhang et al. 2015a); the Shapiro et al. (2016) study also found no association between serum PFOS and glucose tolerance. The ORs for the risk of diabetes and gestational diabetes are graphically presented in Figure 2-38.

PFHxS

Epidemiology Studies. Five general population studies have examined diabetes-related outcomes and have not found associations between serum PFHxS levels and diabetes risk (Lind et al. 2014), gestational diabetes (Shapiro et al. 2016) or insulin, blood glucose, or HOMA-IR levels (Fisher et al. 2013; Lin et al. 2009; Lind et al. 2014; Nelson et al. 2010).

PFNA

Epidemiology Studies. An inverse association between serum PFNA levels and the risk of diabetes was observed in a general population study (Su et al. 2016). Two other studies did not find associations for diabetes (Lind et al. 2014) or gestational diabetes (Zhang et al. 2015a). The Su et al. (2016) study also reported an inverse association between PFNA levels and response on a glucose tolerance test. A study of adolescent NHANES participants found decreasing levels of insulin with increasing serum PFNA levels (Lin et al. 2009); this association was not found in adult NHANES participants (Lin et al. 2009). Several studies did not find associations between serum PFNA levels and HOMA-IR (Lin et al. 2009; Lind et al. 2014; Nelson et al. 2010).

Laboratory Animal Studies. An increase in serum glucose levels was observed in rats administered via gavage 1 mg/kg/day PFNA for 14 days (Fang et al. 2012a).

2. HEALTH EFFECTS

Figure 2-38. Diabetes Risk Relative to Serum PFOS Levels (Presented as Adjusted Odds Ratios)

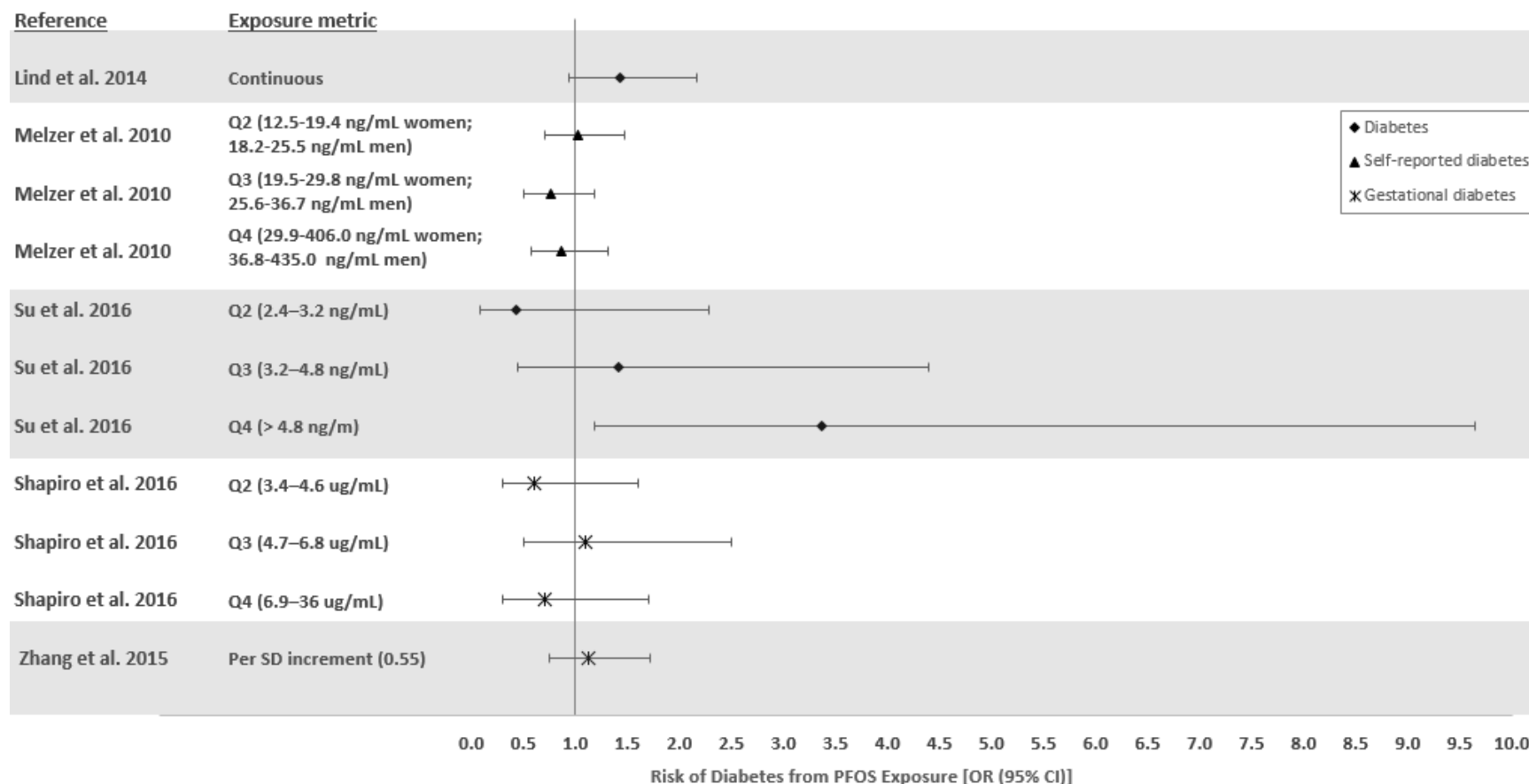

2. HEALTH EFFECTS

PFDeA

Epidemiology Studies. In the only study identified, Zhang et al. (2015a) did not find an association between serum PFDeA levels and the risk of gestational diabetes.

PFUA

Epidemiology Studies. The two epidemiology studies evaluating associations between PFUA and diabetes-related outcomes have found conflicting results. Su et al. (2016) found inverse associations between serum PFUA levels and diabetes risk, fasting blood glucose levels, and glucose tolerance test results, whereas Lind et al. (2014) found no alterations in the risk of diabetes or HOMA.

PFHpA

Epidemiology Studies. Lind et al. (2014) did not find associations between serum PFHpA levels and the risk of diabetes or HOMA alterations.

PFOSA

Epidemiology Studies. In the one epidemiology study identified, no associations between serum PFOSA levels and the risk of diabetes or HOMA were found (Lind et al. 2014).

Me-PFOSA-AcOH

Epidemiology Studies. In a case-control study, Zhang et al. (2015a) did not find alterations in the risk of gestational diabetes associated with serum Me-PFOSA-AcOH levels.

2.19 CANCER

Overview. A number of occupational exposure, community, and general population studies have examined possible associations between perfluoroalkyls and cancer risk; these studies are summarized in Table 2-27 and the *Supporting Document for Epidemiological Studies for Perfluoroalkyls*, Table 15. Occupational and community exposure studies have found increases in the risk of testicular and kidney cancer associated with PFOA. No consistent epidemiologic evidence for other cancer types were found

2. HEALTH EFFECTS

Table 2-27. Summary of Cancer Outcomes in Humans^a

Reference and study population ^b	Serum perfluoroalkyl level	Outcome evaluated	Result ^c
PFOA			
Gilliland and Mandel 1993 Occupational (n=389 deaths) Reference population: Minnesota general population	NR	All cancer deaths	SMR 0.86 (0.72–1.01), males SMR 0.75 (0.56–0.99), females
		Prostate cancer	SMR 2.03 (0.55–4.59) RR 1.13 (1.01–1.27) for a 1-year increase in employment length RR 3.3 (1.02–10.6)* for a 10-year employment length
Leonard 2006; Leonard et al. 2008 Occupational (n=6,027) Reference population: DuPont workers at other regional facilities	5–9,550 ng/mL (estimated range of PFOA)	All cancer deaths	SMR 100 (88–114), males SMR 149 (77–260), females
		Kidney cancer deaths	SMR 185 (95–323), males
		Biliary passages and liver cancer deaths	SMR 133 (53–274)
		Pancreatic cancer deaths	SMR 100 (50–180)
		Bladder or other urinary organ cancer deaths	SMR 131 (53–269)
		Prostate cancer deaths	SMR 65 (34–114)
		Bronchus, trachea, lung cancer deaths	SMR 81 (63–104)
Lundin et al. 2009 Occupational (n=3,993) Reference population: Minnesota general population; for HR analysis comparisons with workers with low exposure or <1 year of exposure	2,600–5,200 and 300–1,500 ng/mL (range of PFOA in subset of current workers with definite exposure jobs and probable exposure jobs)	All cancer deaths	SMR 0.9 (0.5–1.4), definite exposure SMR 0.9 (0.8–1.1), probable exposure
		Pancreas cancer deaths	SMR 0.9 (0.0–4.7), definite exposure SMR 1.0 (0.4–2.1), probable exposure
		Trachea, bronchus, and lung cancer deaths	SMR 1.2 (0.5–2.3), definite exposure SMR 1.0 (0.7–1.4), probable exposure
		Prostate cancer deaths	SMR 2.1 (0.4–6.1), definite exposure SMR 0.9 (0.4–1.8), probable exposure HR 6.6 (1.1–37.7), high exposure ≥6 months HR 3.7 (1.3–10.4), definite exposure for ≥5 years

2. HEALTH EFFECTS

Table 2-27. Summary of Cancer Outcomes in Humans^a

Reference and study population ^b	Serum perfluoroalkyl level	Outcome evaluated	Result ^c
Raleigh et al. 2014 Occupational (n=9,207) Reference population: Minnesota general population	>7.9x10 ⁻⁴ µg/m ³ (cumulative exposure, 4 th PFOA quartile)	All cancer deaths	SMR 0.87 (0.78–0.97)
		Pancreatic cancer deaths	SMR 0.85 (0.50–1.34)
		Prostate cancer deaths	SMR 0.83 (0.53–1.23)
		Kidney cancer deaths	SMR 0.53 (0.20–1.16)
		Liver cancer deaths	SMR 0.81 (0.35–1.59)
		Breast cancer deaths	SMR 0.82 (0.41–1.47)
		Bladder cancer deaths	SMR 0.89 (0.38–1.76)
Raleigh et al. 2014 Occupational (n=9,207) Reference population: non-APFO exposed workers at a St. Paul facility	≤7.9x10 ⁻⁴ and >7.9x10 ⁻⁴ µg/m ³ (cumulative exposure, 3 rd and 4 th PFOA quartile)	Pancreatic cancer deaths	HR 1.23 (0.50–3.00), 3 rd and 4 th quartiles combined
		Pancreatic cancer	HR 1.36 (0.59–3.11), 3 rd and 4 th quartiles combined
		Prostate cancer deaths	HR 1.32 (0.61–2.84), 4 th quartile
		Prostate cancer	HR 1.11 (0.82–1.49), 4 th quartile
		Kidney cancer deaths	HR 0.39 (0.11–1.32), 3 rd and 4 th quartiles combined
		Kidney cancer	HR 0.73 (0.21–2.48), 4 th quartile
		Liver cancer deaths	HR 0.67 (0.14–3.27), 3 rd and 4 th quartiles combined
		Breast cancer deaths	HR 0.54 (0.15–1.94), 3 rd and 4 th quartiles combined
		Breast cancer	HR 1.27 (0.70–2.31), 4 th quartile
		Bladder cancer deaths	HR 1.96 (0.63–6.15), 3 rd and 4 th quartiles combined
Steenland et al. 2015 Occupational (n=3,713)	Cumulative exposure	Bladder cancer	Inverse association (p=0.04 or p=0.06 for trend) with no lag or 10-year lag RR 0.23 (0.05–0.93), 4th quartile with no lag

2. HEALTH EFFECTS

Table 2-27. Summary of Cancer Outcomes in Humans^a

Reference and study population ^b	Serum perfluoroalkyl level	Outcome evaluated	Result ^c
		Colorectal cancer	NS (p=0.91 and 0.86 for trend), with no lag or 10-year lag
		Prostate cancer	NS (p=0.83 and 0.91 for trend), no lag or 10-year lag),
		Melanoma	NS (p=0.16 and 0.55 for trend), no lag or 10-year lag)
Steenland and Woskie 2012	≥2,700,000 ng/mL-years (cumulative 4 th PFOA quartile)	All cancer deaths	SMR 0.94 (0.76–1.16), 4 th quartile
Occupational (n=1,084 deceased workers) Reference population: DuPont workers at other regional facilities		Pancreatic cancer deaths	SMR 0.92 (0.30–2.16), 4 th quartile
		Lung cancer deaths	SMR 0.75 (0.48–1.11), 4 th quartile
		Prostate cancer deaths	SMR 0.57 (0.16–1.46), 4 th quartile
		Bladder cancer deaths	SMR 0.36 (0.10–2.01), 4 th quartile
		Kidney cancer deaths	SMR 2.66 (1.15–5.24)*, 4th quartile SMR 2.82 (1.13–5.81)*, 10-year lag SMR 3.67 (1.48–7.57)*, 20-year lag
Barry et al. 2013	Cumulative exposure	Testicular cancer	HR 1.34 (1.00–1.79, p=0.05)* no lag HR 1.28 (0.95–1.73, p=0.10) 10-year lag HR 3.17 (0.75–13.45, p=0.04 for trend)*, 4th quartile
Community and occupational (n=32,254)	24.2 and 112.7 ng/mL (median PFOA)	Kidney cancer	HR 1.10 (0.98–1.24, p=0.10), no lag (continuous) HR 1.58 (0.88–2.84, p=0.18 for trend), 4 th quartile
		Breast cancer	HR 0.94 (0.89–1.00, p=0.05)*, no lag HR 0.93 (0.88–0.99, p=0.03)*, 10-year lag
		Colorectal cancer	HR 0.99 (0.92–1.07, p=0.84), no lag

2. HEALTH EFFECTS

Table 2-27. Summary of Cancer Outcomes in Humans^a

Reference and study population ^b	Serum perfluoroalkyl level	Outcome evaluated	Result ^c
Ducatman et al. 2015a, 2015b Community (C8) (n=25,412 men)	86.6 ng/mL (mean PFOA)	Prostate specific antigen	NS (p<0.05)
Innes et al. 2014 Community (n=208 cases of colorectal cancer and 47,359 cancer-free adults)	13.5–27.8 ng/mL (2 nd PFOA quartile)	Colorectal cancer	OR 0.47 (0.31–0.74)*, 2nd quartile
Vieira et al. 2013 Community (n=25,107)	30.8–109 and 110–655 ng/mL (estimated PFOA in high and very high exposure groups)	Kidney cancer	AOR 2.0 (1.3–3.2)*, high exposure group AOR 2.0 (1.0–3.9), very high exposure group
		Testes cancer	AOR 2.8 (0.8–9.2), very high exposure group
		Prostate cancer	AOR 1.5 (0.9–2.5), very high exposure group
		Breast cancer	AOR 1.4 (0.9–2.3) very high exposure group, females only
Bonefeld-Jorgensen et al. 2011 General population (n=31 breast cancer cases and 115 matched controls)	2.5 and 1.6 ng/mL (median PFOA in cases and controls)	Breast cancer	AOR 1.20 (0.77–1.88, p=0.43)
Bonefeld-Jorgensen et al. 2014 General population (n=250 breast cancer cases and 233 matched controls)	5.2 ng/mL (mean PFOA)	Breast cancer	RR 1.00 (0.90–1.11).
Eriksen et al. 2009 General population (n=713 for prostate cancer, n=332 for bladder cancer, n=128 for pancreatic cancer, n=67 for liver cancer, and n=772 controls)	6.8 and 6.0 ng/mL (median PFOA in male and female cancer patients) 6.9 and 5.4 ng/mL (median PFOA in male and female controls)	Prostate cancer	IRR 1.18 (0.84–1.65)
		Bladder cancer	IRR 0.81 (0.53–1.24)
		Pancreas cancer	IRR 1.55 (0.85–2.80)
		Liver cancer	IRR 0.60 (0.26–1.37)

2. HEALTH EFFECTS

Table 2-27. Summary of Cancer Outcomes in Humans^a

Reference and study population ^b	Serum perfluoroalkyl level	Outcome evaluated	Result ^c
Hardell et al. 2014 General population (n=201 cases and 186 controls)	2.3 and 1.9 ng/mL (mean PFOA in cases and controls)	Prostate cancer	OR 1.1 (0.7–1.7) OR 2.6 (1.2–6.0)*, among subjects with a heredity risk and serum PFOA above the median
PFOS			
Alexander et al. 2003 Occupational (n=2,083; 145 deaths) Reference population: Alabama general population	NR	All cancer deaths Bladder and other urinary organs cancer	SMR 0.84 (0.50–1.32), high potential exposure group SMR 12.77 (2.63–37.35)*, high potential exposure group SMR 16.12 (3.32–47.14)*, high exposure group ≥1 year exposure
Alexander and Olsen 2007 Occupational (n=1,895; 1,488 deaths) Reference population: NIOSH SEER referent data	NR	Bladder cancer	SIR 1.74 (0.64–3.79), high potential exposure group SIR 1.43 (0.16–5.15) ≥10-year exposure group
Grice et al. 2007 Occupational (n=1,400 current, retired, or former workers)	1,300–1,970 ng/mL (PFOS levels in high potential exposure group)	Colon cancer Melanoma Prostate cancer	OR 1.69 (0.68–4.17) OR 1.01 (0.25–4.11) OR 1.08 (0.44–2.69)
Olsen et al. 2004a Occupational (current and retired workers)	NR	Malignant melanoma of the skin Malignant neoplasm of the colon	RRE _{pC} 12 (1.0→100) RRE _{pC} 10 (0.7→100), >10 years employment RRE _{pC} 5.4 (0.5→100) RRE _{pC} 12 (0.8→100), >10 years employment
Ducatman et al. 2015a, 2015b Community (C8) (n=25,412 men)	22.18 ng/mL (mean PFOS)	Prostate specific antigen	NS (p<0.05)
Innes et al. 2014 Community (n=208 cases of colorectal cancer and 47,359 cancer-free adults)	13.6–20.1 ng/mL (2 nd PFOS quartile)	Colorectal cancer	OR 0.35 (0.24–0.53)*

2. HEALTH EFFECTS

Table 2-27. Summary of Cancer Outcomes in Humans^a

Reference and study population ^b	Serum perfluoroalkyl level	Outcome evaluated	Result ^c
Bonefeld-Jorgensen et al. 2011 General population (n=31 breast cancer cases and 115 matched controls)	45.6 and 21.9 ng/mL (median PFOS in cases and controls)	Breast cancer	OR 1.03 (1.001–1.07, p=0.05)*
Bonefeld-Jorgensen et al. 2014 General population (n=250 breast cancer cases and 115 matched controls)	30.6 ng/mL (mean PFOS)	Breast cancer	RR 0.99 (0.98–1.01)
Eriksen et al. 2009 General population (n=713 for prostate cancer, n=332 for bladder cancer, n=128 for pancreatic cancer, n=67 for liver cancer, and n=772 controls)	35.1 and 32.1 ng/mL and 35.0 and 29.3 ng/mL (median PFOS in male and female cancer patients and males and females in the comparison group)	Prostate cancer	IRR 1.05 (0.97–1.14)
		Bladder cancer	IRR 0.93 (0.83–1.03)
		Pancreas cancer	IRR 0.99 (0.86–1.14)
		Liver cancer	IRR 0.59 (0.27–1.27)
Hardell et al. 2014 General population (n=201 cases of prostate cancer and 186 controls)	11 and 10 ng/mL (mean PFOS in cases and controls)	Prostate cancer	OR 1.0 (0.6–1.5) OR 2.7 (1.04–6.8)*, among subjects with a heredity risk and serum PFOS above the median
PFHxS			
Ducatman et al. 2015a, 2015b Community (C8) (n=25,412 men)	3.58 ng/mL (mean PFHxS)	Prostate specific antigen	NS (p<0.05)
Bonefeld-Jorgensen et al. 2014 General population (n=250 breast cancer cases and 115 matched controls)	1.2 ng/mL (mean PFHxS)	Breast cancer	RR 0.66 (0.47–0.94)*
Hardell et al. 2014 General population (n=201 cases of prostate cancer and 186 controls)	1.1 and 0.940 ng/mL (mean PFHxS in cases and controls)	Prostate cancer	OR 1.3 (0.8–1.9) OR 4.4 (1.7–12)*, among subjects with a heredity risk and serum PFHxS above the median

2. HEALTH EFFECTS

Table 2-27. Summary of Cancer Outcomes in Humans^a

Reference and study population ^b	Serum perfluoroalkyl level	Outcome evaluated	Result ^c
PFNA			
Ducatman et al. 2015a, 2015b Community (C8) (n=25,412 men)	1.47 ng/mL (mean PFNA)	Prostate specific antigen	NS (p<0.05)
Bonefeld-Jorgensen et al. 2014 General population (n=250 breast cancer cases and 115 matched controls)	0.5 ng/mL (mean PFNA)	Breast cancer	RR 0.76 (0.30–1.94)
Hardell et al. 2014 General population (n=201 cases of prostate cancer and 186 controls)	0.679 and 0.631 ng/mL (mean PFNA in cases and controls)	Prostate cancer	OR 1.2 (0.8–1.8) OR 2.1 (0.9–4.8), among subjects with a heredity risk and serum PFNA above the median
PFDeA			
Hardell et al. 2014 General population (n=201 cases of prostate cancer and 186 controls)	0.338 and 0.291 ng/mL (mean PFDeA in cases and controls)	Prostate cancer	OR 1.4 (0.9–2.1) OR 2.6 (1.1–6.1)*, among subjects with a heredity risk and serum PFDeA above the median
PFUA			
Hardell et al. 2014 General population (n=201 cases of prostate cancer and 186 controls)	0.308 and 0.285 ng/mL (mean PFUA in cases and controls)	Prostate cancer	OR 1.2 (0.8–1.9) OR 2.6 (1.1–5.9)*, among subjects with a heredity risk and serum PFUA above the median

2. HEALTH EFFECTS

Table 2-27. Summary of Cancer Outcomes in Humans^a

Reference and study population ^b	Serum perfluoroalkyl level	Outcome evaluated	Result ^c
PFOSA			
Bonefeld-Jorgensen et al. 2014	3.5 ng/mL (mean PFOSA)	Breast cancer	RR 1.89 (1.01–3.54)*, among women with serum PFOSA >5.75 ng/mL
General population (n=250 breast cancer cases and 115 matched controls)			

^aSee the *Supporting Document for Epidemiological Studies for Perfluoroalkyls*, Table 15 for more detailed descriptions of studies.

^bParticipants in occupational exposure may have also lived near the site and received residential exposure; community exposure studies involved subjects living near PFOA facilities with known exposure to high levels of PFOA.

^cAsterisk indicates association with perfluoroalkyl compound; unless otherwise specified, values in parenthesis are 95% confidence intervals.

AOR = adjusted odds ratio; CI = confidence interval; HR = hazard ratio; IRR = incidence rate ratio; NIOSH = National Institute for Occupational Safety and Health; NR = not reported; NS = not significant; OR = odds ratio; PFDeA = perfluorodecanoic acid; PFHxS = perfluorohexane sulfonic acid; PFNA = perfluorononanoic acid; PFOA = perfluorooctanoic acid; PFOS = perfluorooctane sulfonic acid; PFOSA = perfluorooctane sulfonamide; PFUA = perfluoroundecanoic acid; RR = relative risk; RRE_pC = risk ratio episodes of care; SEER = Surveillance Epidemiology and End Results; SIR = standardized incidence ratio; SMR = standardized mortality ratio

2. HEALTH EFFECTS

for PFOA. For PFOS, one occupational exposure study reported an increase in bladder cancer, but this was not supported by subsequent occupational studies. General population studies have not consistently reported increases in malignant tumors for PFOS. Epidemiology studies examining other perfluoroalkyl compounds consisted of two case-control studies. No increases in breast cancer risk were observed for PFHxS or PFNA; an increased breast cancer risk was observed for PFOSA. Another case-control study did not find increases in prostate cancer for PFOA, PFOS, PFHxS, PFNA, PFDeA, or PFUA. However, among men with a first-degree relative with prostate cancer, associations were found for PFOA, PFOS, PFHxS, PFDeA, and PFUA, but not for PFNA.

Laboratory animal studies have evaluated the carcinogenicity of PFOA and PFOS; the results of these studies are summarized in Tables 2-3 and 2-4. In laboratory animals, there is some evidence for increases in Leydig cell adenomas and pancreatic acinar cell adenomas in male rats exposed to PFOA in the diet.

An increase in hepatocellular adenomas was observed in male rats exposed to dietary PFOS for 2 years; thyroid follicular cell adenomas were observed in rats exposed to PFOS for 1 year and allowed to recover for an additional year.

EPA (2016e, 2016f) has concluded that there is suggestive evidence of the carcinogenic potential of PFOA and PFOS in humans. IARC (2017) concluded that PFOA is possibly carcinogenic to humans (Group 2B).

PFOA

Epidemiology Studies. Several studies have examined the possible association between occupational exposure to PFOA and increased cancer risk in workers at two U.S. facilities—3M facility in Cottage Grove, Minnesota (Gilliland and Mandel 1993; Lundin et al. 2009; Raleigh et al. 2014) and DuPont Washington Works facility in West Virginia (Leonard 2006; Leonard et al. 2008; Steenland and Woskie 2012; Steenland et al. 2015). In addition, the potential carcinogenicity of PFOA has been assessed in the community near the Washington Works facility (Barry et al. 2013; Innes et al. 2014; Vieira et al. 2013) and in the general population (Bonfeld-Jorgensen 2011, 2014; Eriksen et al. 2009; Hardell et al. 2014).

Occupational exposure studies have not found increases in the risk of all cancer deaths (Gilliland and Mandel 1993; Leonard 2006; Leonard et al. 2008; Lundin et al. 2009; Raleigh et al. 2014; Steenland and Woskie 2012). The occupational exposure studies have consistently found no increases in the risk of

2. HEALTH EFFECTS

pancreatic, liver, or respiratory tract cancers or deaths from these cancers (Leonard 2006; Leonard et al. 2008; Lundin et al. 2009; Raleigh et al. 2014; Steenland and Woskie 2012); a general population case-control study also found no associations between serum PFOA and pancreas or liver cancer (Eriksen et al. 2009). Additionally, two case-control studies did not find associations between serum PFOA levels and risk of breast cancer (Bonfeld-Jorgensen et al. 2011, 2014). Steenland et al. (2015) found an inverse association between cumulative PFOA exposure and bladder cancer in workers; other studies have not found associations (Eriksen et al. 2009; Gilliland and Mandel 1993; Leonard 2006; Leonard et al. 2008; Raleigh et al. 2014; Steenland and Woskie 2012).

Some associations between PFOA and cancer effects have been observed, including prostate, kidney, and testicular cancers. Ten years of employment in the Chemical Division of the 3M Cottage Grove facility was associated with a 3.3-fold increase in the relative risk of prostate cancer mortality, as compared to no employment in PFOA production areas (Gilliland and Mandel 1993); no increase in prostate cancer risk was observed when all workers in the Chemical Division were analyzed. The investigators noted that the prostate cancer findings are based on a small number of cases and could have resulted from chance or unrecognized confounding from exposure to other factors. An update of this study conducted by Lundin et al. (2009) did not find an increase in prostate cancer deaths in workers with definite PFOA exposure. When the cohort was divided into the three exposure categories and duration of definite exposure, increased risks for prostate cancer were found in the high-exposure category and in workers with definite exposure for at least 5 years, as compared with workers in the low-exposure category and with the shortest cumulative exposure duration, respectively. Interpretation of the Gilliland and Mandel (1993) and Lundin et al. (2009) studies is limited by the qualitative assessment of potential exposure and the fact that workers in the low exposure categories were likely research-and-development professionals rather than production workers (Raleigh et al. 2014). In the most recent evaluation of the Cottage Grove facility, which involved extensive exposure assessment, Raleigh et al. (2014) did not find increases in prostate cancer deaths when compared to the general population or to workers at another facility and did not find an increase in the incidence of prostate cancer when the workers were categorized by cumulative exposure levels. Studies of the Washington Works facility workers did not find increases in prostate cancer deaths (Leonard et al. 2008; Steenland and Woskie 2012) or incidence (Steenland et al. 2015). A case-control general population study by Hardell et al. (2014) did find an increase in prostate risk only among subjects with a heredity risk (first-degree relative with prostate cancer) and serum PFOA levels above the median. In a study of community members, Ducatman et al. (2015b) did not find an association between prostate-specific antigen (PSA) levels and serum PFOA levels in men 20–49 or 50–69 years of age.

2. HEALTH EFFECTS

In the earliest cancer assessment of workers at the Washington Works facility (Leonard 2006; Leonard et al. 2008), an increase in the number of deaths from kidney cancer relative to workers at other regional DuPont facilities was observed; however, the CI included unity. In a follow-up study that used serum PFOA levels collected in current workers to assess job title exposure (Steenland and Woskie 2012), an increase in kidney cancer deaths was observed in workers with the highest exposures when analyzed with no lag, a 10-year lag, or a 20-year lag. Steenland and Woskie (2012) also found an increase in deaths from mesothelioma; the investigators noted that this was likely due to asbestos exposure. Steenland and Woskie (2012) noted that tetrafluoroethylene, a rodent kidney carcinogen, is used in the manufacture of a variety of fluoropolymers and noted that the tetrafluoroethylene is well controlled due to its volatile and explosive properties. It is noted that in a multisite study of tetrafluoroethylene workers, which included workers at the Washington Works facility (Consonni et al. 2013), an increased risk of renal cancer (SMR 1.44, 95% CI 0.69–2.65) was found, although the CI included unity. Consonni et al. (2013) noted that 88% of the workers were also exposed to PFOA. When PFOA exposure was used as an exposure variable, the findings were the similar as when tetrafluoroethylene was used as the exposure variable, and thus, it was difficult for the investigators to evaluate separate associations for each compound. It is noted that increases in kidney deaths were not observed in the Cottage Grove facility (Raleigh et al. 2014), which did not use tetrafluoroethylene (Chang et al. 2014).

Three studies have examined the community living near the Washington Works facilities; some of these studies also included workers at the facility. Barry et al. (2013) reported an increased risk of testicular cancer that was associated with cumulative PFOA exposure. Vieira et al. (2013) also reported an increase in testicular cancer, but the CIs of the adjusted odds ratio (AOR) included unity. When the participants were grouped by water district, an increased risk of testicular cancer (AOR 5.1, 95% CI 1.6–15.6) was observed in the Little Hocking water district, which had the highest PFOA levels in the water. The Vieira et al. (2013) study also found increased risks of kidney cancer among participants with high or very high exposure to PFOA; Barry et al. (2013) also concluded that there was an association between cumulative PFOA exposure and kidney cancer, although the CIs for the hazard ratio included unity. The third study of the Washington Works community found an inverse association between serum PFOA and risk of colorectal cancer (Innes et al. 2014).

In their review of the available epidemiology data, IARC (2017) concluded that the evidence for testicular cancer was “considered credible and unlikely to be explained by bias and confounding, however, the estimate was based on small numbers.” Similarly, IARC (2017) concluded that the evidence for kidney

2. HEALTH EFFECTS

cancer was also credible but noted that chance, bias, and confounding could not be ruled out with reasonable confidence. They considered that there was limited evidence in humans for the carcinogenicity of PFOA.

Laboratory Animal Exposure Studies. Two studies have examined the carcinogenic potential of PFOA in rats. In the first study of male and female Sprague-Dawley rats exposed to PFOA in the diet for 2 years (3M 1983), significant increases in the incidence of fibroadenoma of the mammary gland in females and Leydig cell adenoma were found in males exposed to 15 mg/kg/day. A high incidence of pituitary adenoma occurred among all groups, including controls. The incidence of hepatocellular carcinoma was not significantly increased. The investigators noted that the incidence of fibroadenoma in the mammary gland in the 15 mg/kg/day group was similar to the incidence found in untreated aging rats and that the incidence of Leydig cell adenoma was similar to the spontaneous incidence of this tumor in aged rats. The mammary gland pathology slides from the 3M (1983) study were re-examined in 2005 by a Pathology Working Group (PWG) using current diagnostic criteria (Hardisty et al. 2010). The incidences of fibroadenoma found by the PWG were 36, 44, and 46% in the 0, 1, and 15 mg/kg/day groups, respectively; there were no statistically significant differences between the groups (Hardisty et al. 2010). Additionally, there were no significant differences in the incidence of adenocarcinoma, total benign neoplasms, or total malignant neoplasms between the groups. In the second study of male Sprague-Dawley rats exposed to PFOA in the diet for 2 years (Biegel et al. 2001), an increase in the incidence of hepatocellular adenomas was found, but there were no hepatocellular carcinomas in the treated group. PFOA also increased the incidence of Leydig cell adenomas. In addition, PFOA increased the incidence of pancreatic acinar cell adenomas; a pancreatic carcinoma was observed in one treated rat. Hepatic peroxisome proliferation was increased significantly at all interim evaluation time points (1, 3, 6, 9, 12, 15, 18, and 21 months), but there was no increase in cell proliferation. In Leydig cells, neither peroxisome proliferation nor cell proliferation were increased.

PFOA was a positive modulator of hepatocarcinogenesis in male Wistar rats in a biphasic (initiation with diethylnitrosamine followed by oral treatment with PFOA) or triphasic (initiation with diethylnitrosamine [DEN] followed by dosing with 2-acetylaminofluorene and then PFOA) promotion protocol (Abdellatif et al. 1991, 2004). PFOA induced a marked increase in acylCoA oxidase activity and only a slight increase in catalase activity (Abdellatif et al. 2004). Since PFOA did not significantly increase 8-hydroxy-deoxyguanosine (a marker of oxidative DNA damage *in vivo*) in isolated liver DNA, it appeared that PFOA did not require extensive DNA damage for its promoting activity (Abdellatif et al. 2004). PFOA

2. HEALTH EFFECTS

was also found to act as a promoter in male Wistar rats in an initiation-selection-promotion protocol (Nilsson et al. 1991).

IARC (2017) concluded that there was limited evidence in experimental animals for the carcinogenicity of PFOA.

PFOS

Epidemiology Studies. Four studies have evaluated the carcinogenic potential in workers at a Decatur, Alabama perfluorooctanesulphonyl fluoride (PFOSF) based fluorochemical production facility. In the earliest study, no increase in all cancer deaths was found, as compared to the Alabama general population (Alexander et al. 2003). An increased risk of bladder cancer was observed in workers with high potential exposure and in workers with a high potential exposure for ≥ 1 year; the mortality ratio was based on three cases in the high exposure group. In a reanalysis of workers at this facility conducted by Alexander and Olsen (2007), 11 cases of bladder cancer were identified from worker surveys ($n=6$) and death certificates ($n=5$). Only two of the six self-reported bladder cancer diagnosis were confirmed via medical records; the other four subjects declined to give consent for medical verification. When compared to incidence data from the National Institute for Occupational Safety and Health (NIOSH) Surveillance Epidemiology and End Results (SEER) referent data, the standardized incidence ratios for the high potential exposure group were elevated, but the CIs included unity. When compared with workers with <1 year of high exposure, workers with $5-<10$ and ≥ 10 years of high exposure had relative risks of 1.92 (95% CI 0.30–12.06) or 1.52 (95% CI 0.21–10.99). Although the study did not adjust for smoking, the investigators noted that 83% of the living bladder cancer cases (five of the six subjects) reported cigarette use, as compared to 56% reported in the noncases. An additional limitation of the study is inclusion of four cases of bladder cancer that were not verified by medical records. The results of this study do not appear to confirm the findings of increased bladder cancer in the mortality study (Alexander et al. 2003). In a subsequent study of this facility, treatment for bladder cancer was not reported among current workers (Olsen et al. 2004a). The study did find increases in the number of episodes of care for malignant neoplasm of the prostate or malignant neoplasms of the colon, as compared to long-term workers in another division, but the CIs included unity. No increases in the risk ratio episodes of care were found for liver, rectum, or respiratory tract (Olsen et al. 2004a). A fourth study of this facility (Grice et al. 2007) examined possible associations between colon cancer, melanoma, and prostate cancer and PFOS exposure. The risks of these cancers were not associated with any of the PFOS-exposure categories for analyses that included all self-reported or only validated cancers.

2. HEALTH EFFECTS

General population case-control studies have evaluated several cancer types. Innes et al. (2014) reported an inverse association between PFOS and colorectal cancer. A small-scale study of 31 cases by Bonefeld-Jorgensen et al. (2011) found a slight increase in breast cancer risk, a finding not replicated in another larger study of a different population (Bonefeld-Jorgensen et al. 2014). Eriksen et al. (2009) and Hardell et al. (2014) did not find increases in the risk of prostate cancer associated with serum PFOS. However, an increased risk of prostate cancer was found among subjects with a first-degree relative with prostate cancer and PFOS levels above the median level (Hardell et al. 2014). Eriksen et al. (2009) also found no associations between serum PFOS and the risk of bladder cancer, pancreatic cancer, or liver cancer. Ducatman et al. (2015b) did not find an association between serum PFOS levels and PSA levels in men participating in the C8 studies.

Laboratory Animal Studies. In a 2-year PFOS dietary exposure study bioassay in male and female Sprague-Dawley rats (Butenhoff et al. 2012b; unpublished study by Thomford 2002b), a significant positive trend of hepatocellular adenoma was observed in males; the incidence was significantly higher than controls at 1.04 mg/kg/day. No hepatocellular adenomas were seen in a group of rats exposed to 1.17 mg/kg/day for 1 year and allowed to recover for the second year. High-dose males from the recovery group showed a significant increase in thyroid follicular cell adenoma relative to controls. No significant increase in this type of tumor was observed in rats exposed for 2 years. In females, there was a significant positive trend for incidences of hepatocellular adenoma, which was associated with a significant increase in the 1.04 mg/kg/day group. In females, there were also significant negative trends for mammary adenoma and fibroadenoma carcinoma combined.

PFHxS

Epidemiology Studies. Two case-control studies have examined the possible association between serum PFHxS and cancer. Bonefeld-Jorgensen et al. (2014) found an inverse association between PFHxS levels and breast cancer risk. No association between PFHxS and prostate cancer was observed (Hardell et al. 2014), with the exception of increased risk in men with a first-degree relative with prostate cancer and above-median serum PFHxS levels. No associations between serum PFHxS and PSA levels were observed in men 20–49 or 50–69 years of age participating in the C8 Health Studies (Ducatman et al. 2015b).

2. HEALTH EFFECTS

PFNA

Epidemiology Studies. The carcinogenic potential of PFNA has been examined in two case-control studies. No associations between serum PFNA levels and breast cancer (Bonfeld-Jorgensen et al. 2014) or prostate cancer (Hardell et al. 2014) were found. Serum PSA levels were not associated with serum PFNA levels in men participating in the C8 Health Study (Ducatman et al. 2015b).

PFDeA

Epidemiology Studies. Hardell et al. (2014) examined the possible association between the serum PFDeA level and risk of prostate cancer and only found an association in men with a heredity risk factor and PFDeA levels above the median.

PFUA

Epidemiology Studies. An increased risk of prostate cancer was found in men with first-degree relatives with prostate cancer and serum PFUA levels above the median (Hardell et al. 2014).

PFOSA

Epidemiology Studies. Bonfeld-Jorgensen et al. (2014) reported an increased risk of breast cancer among women with serum PFOSA levels >5.75 ng/mL.

2.20 MECHANISM OF TOXICITY

The primary effects observed in laboratory animals exposed to perfluoroalkyl compounds are liver toxicity, developmental toxicity, and immune toxicity. The cellular mechanisms by which hepatic effects are induced have been extensively studied, while more limited data are available on mechanisms for other effects. The available data indicate that perfluoroalkyl compounds produce a number of adverse effects through activation of the PPAR α , a member of the nuclear receptor superfamily that mediates a broad range of biological responses (Issemann and Green 1990). However, some adverse effects of perfluoroalkyl compounds occur through PPAR α -independent mechanisms, which may include activation of other nuclear receptors, increased oxidative stress, dysregulation of mitochondrial function, and inhibition of gap junction intercellular communication (GJIC). In the sections below, cellular

2. HEALTH EFFECTS

mechanisms of action that are mediated by PPAR α and independent of PPAR α are discussed, followed by discussions of mechanisms specific to the hepatic, developmental, immunotoxic, and hormone effects of perfluoroalkyl compounds.

2.20.1 Cellular Mechanisms of Toxicity

PPAR α -Dependent Mechanisms

Activation of the PPAR α receptor in rodents initiates a characteristic sequence of morphological and biochemical events, principally, but not exclusively, in the liver. These events include marked hepatocellular hypertrophy due to an increase in number and size of peroxisomes, a large increase in peroxisomal fatty acid β oxidation, increased cytochrome 450-mediated ω hydroxylation of lauric acid, and alterations in lipid metabolism. Proliferation of peroxisomes in laboratory animals exposed to perfluoroalkyl compounds is discussed in Section 2.9 (Hepatic); as discussed in that section, hepatic peroxisome proliferation has been shown in rats exposed to PFOA and in mice exposed to PFDeA.

Many, but not all, of the adverse effects induced by perfluoroalkyl compounds are mediated through activation of the PPAR α . Ligands, including perfluoroalkyl compounds, bind to and activate PPAR α , causing a conformational change in the receptor that leads to dissociation of co-repressors and enables heterodimerization with the retinoid X receptor (Corton et al. 2014). The activated receptor complex binds to a DNA direct repeat motif (the peroxisome proliferator response element or PPRE) located in the promoters of peroxisome proliferator responsive genes. The binding of the receptor complex leads to recruitment of co-activators that acetylate histones and remodel chromatin, enabling RNA polymerase to transcribe the target gene(s). PPAR α regulates lipid homeostasis by modulating the expression of genes involved in fatty acid uptake, activation, and oxidation. Activation of nuclear receptors including PPAR α is a complex, dynamic process that depends on levels of expression of the receptors in different tissues, competition among receptors for endogenous and exogenous ligands and for binding sites on chromatin, and availability and abundance of co-activators and/or co-repressors (Corton et al. 2014).

PPAR α Receptor Activation. Many perfluoroalkyl compounds, including PFOA, PFOS, PFUA, PFHpA, PFDoA, and perfluoropentanoic acid have been shown to activate PPAR α in mammalian cells *in vitro* (Bjork and Wallace 2009; Bjork et al. 2011; Shipley et al. 2004; Takacs and Abbott 2007; Vanden Heuvel et al. 2006; Wolf et al. 2008b, 2012). Cell systems used in these studies include COS-1 cells expressing mouse, rat, or human PPAR α , and cultured rat, mouse, and human hepatocytes. In these studies,

2. HEALTH EFFECTS

perfluoroalkyl sulfonate compounds were less potent than perfluoroalkyl carboxylate compounds in activating PPAR α -induced gene expression, and the potency of stimulation within each class increased with carbon chain length (Bjork and Wallace 2009; Wolf et al. 2008b, 2012). In comparison with naturally occurring long-chain fatty acids such as linoleic and α linoleic acids, PFOA and PFOS are relatively weak ligands for PPAR α (Vanden Heuvel et al. 2006)

PPAR α -Dependent Gene Expression Changes. Perfluoroalkyl compounds have been shown to induce changes in the expression of genes under the regulation of PPAR α . The expression of PPAR α target genes involved in fatty acid metabolism, cell cycle control, peroxisome biogenesis, and proteasome structure and organization were upregulated, while inflammatory response genes were downregulated, in wild-type mice exposed orally to PFOA or the PPAR α agonist WY-14,643 (Rosen et al. 2008a). Furthermore, PFOA and PFDA have been shown to downregulate, via PPAR α activation, genes involved in bile transport in the livers of mice exposed by intraperitoneal administration (Cheng and Klaassen 2008a). Both compounds decreased expression of organic anion transporting polypeptides [*OATP1a1*, *1a4*, and *1b2*], and PFDA also downregulated sodium-taurocholate cotransporting polypeptide [*Nctp*], via activation of PPAR α . Many of these expression changes may play roles in the hepatic effects of perfluoroalkyl compounds, and the diminished expression of inflammatory response genes may be involved in immunosuppression induced by perfluoroalkyl compounds.

Gene expression changes induced by perfluoroalkyl compounds have been extensively studied in experiments aimed at determining the extent to which the adverse effects of these compounds are dependent on activation of PPAR α or interaction with other nuclear receptors (Foreman et al. 2009; Rosen et al. 2008a, 2008b, 2010, 2017). These studies, comparing gene expression changes in wild-type and PPAR α -null mice exposed to perfluoroalkyl compounds, demonstrate the following:

- A majority of the gene expression changes induced in rodents by perfluoroalkyl compounds tested to date, especially PFOA and PFNA, are dependent on activation of PPAR α .
- Perfluoroalkyl compounds also induce gene expression changes that are independent of PPAR α .
- The extent to which gene expression changes induced by perfluoroalkyls are dependent on activation of PPAR α varies by compound.
- PPAR α -independent gene expression changes induced by perfluoroalkyl compounds are similar to those induced by compounds that activate PPAR γ , constitutive androstane receptor (CAR), and estrogen receptor alpha (ER α) (discussed further under PPAR α -independent mechanisms).

2. HEALTH EFFECTS

Species Differences in PPAR α Activation. Species differences in response to PPAR α activators have been reviewed by Corton et al. (2014). Studies of PPAR α activation by structurally diverse ligands in various species have shown that rats and mice are the most sensitive species to PPAR α agonists, whereas guinea pigs, hamsters, nonhuman primates, and humans are less responsive (Corton et al. 2014). However, the differences do not appear to result from differences in the PPAR α gene itself: PPAR α cDNA from humans is indistinguishable from the rodent PPAR α . Species differences in response to exogenous PPAR α activators may stem from any or all of the following: (1) differences in the expression of PPAR α in a given tissue; (2) differences in the gene product structure; and (3) differences in the ligand-mediated transactivation of PPAR α . Experiments quantifying mRNA and/or protein levels of PPAR α show ~10-fold higher expression of PPAR α in the livers of mice and rats compared with humans and guinea pigs, but available data are limited and require further study to validate these differences (Corton et al. 2014). In humans, variants of PPAR α that may affect its transactivation potential have been identified. For example, humans produce higher levels of a truncated PPAR α (that lacks a ligand binding domain) compared with mice and rats (Corton et al. 2014). The truncated form appears to inhibit the activity of the full-length receptor, possibly via sequestering critical co-activators. Other, non-truncated variants of PPAR α have been identified in humans, but the sensitivity of these variants to PPAR α activators does not differ markedly from that of the wild-type receptor.

Species and compound-related differences in PPAR α transactivation by perfluoroalkyl compounds have been demonstrated *in vitro* (Shiple et al. 2004; Takacs and Abbott 2007; Vanden Heuvel et al. 2006; Wolf et al. 2008b, 2012). In a comparison of human and mouse PPAR α transactivation by different perfluoroalkyl compounds in transfected COS-1 cells, Wolf et al. (2008b, 2012; see Table 2-28) found that some perfluoroalkyls exhibited marked species differences in transactivation potency (for example, PFUA, PFDeA, PFDoA), while other compounds showed similar transactivation potency for both human and mouse PPAR α (for example, PFNA, PFOA, perfluoropentanoic acid [PFPeA]).

Table 2-28. Transactivation of Human and Mouse PPAR α in Transfected Cos-1 Cells Exposed to Perfluoroalkyl Compounds (In Order of Decreasing C_{20max} in the Mouse)

Perfluoroalkyl	Carbon number	Human		Mouse		C _{20max} (μ M) ^a	
		NOEC (μ M)	LOEC (μ M)	NOEC (μ M)	LOEC (μ M)	Human	Mouse
PFNA	9	1	5	1	5	11	5
PFOA ^b	8	5, 0.5	10,1	0.5, 1	1, 3	7	6

2. HEALTH EFFECTS

Table 2-28. Transactivation of Human and Mouse PPAR α in Transfected Cos-1 Cells Exposed to Perfluoroalkyl Compounds (In Order of Decreasing C_{20max} in the Mouse)

Perfluoroalkyl	Carbon number	Human		Mouse		C _{20max} (μ M) ^a	
		NOEC (μ M)	LOEC (μ M)	NOEC (μ M)	LOEC (μ M)	Human	Mouse
PFUA	11	50	75	5	10	86	8
PFHpA	7	<0.5	0.5	3	5	15	11
PFDeA	10	100	>100 ^c	<5	5	–	20
PFD _o A	12	75	90	3	5	NA	33
PFPeA	5	0.5	1	1	5	52	45
PFHxA	6	5	10	10	20	86	45
PFBA	4	30	40	30	40	75	51
PFHxS	6	5	10	10	20	81	76
PFOS	9	20	30	60	90	262	94
PFBuS	4	20	30	120	150	206	317

^aPerfluoroalkyl concentration yielding 20% of maximum response given by the most active compound (PFNA).

^bResults from two separate experiments.

^cSlope for human PPAR α dose-response line was not significant.

– = not active; LOEC = lowest-observed-effect concentration; NA = not available; NOEC = no-observed-effect concentration; PFBA = perfluorobutyric acid; PFBuS = perfluorobutane sulfonic acid; PFDeA = perfluorodecanoic acid; PFD_oA = perfluorododecanoic acid; PFHpA = perfluoroheptanoic acid; PFHxA = perfluoroheptanoic acid; PFHxS = perfluoroheptane sulfonic acid; PFNA = perfluorononanoic acid; PFOA = perfluorooctanoic acid; PFOS = perfluorooctane sulfonic acid; PFPeA = perfluoropentanoic acid; PFUA = perfluoroundecanoic acid; PPAR = peroxisome proliferator activated receptor

Source: Wolf et al. 2008b, 2012

In addition to differences in transactivation of PPAR α , Corton et al. (2014) noted that there are species differences in the transcripts controlled by PPAR α . While PPAR α activation leads to hypolipidemic changes in both humans and laboratory rodents, the gene sets responsible for these changes may differ. In a comparison between human and mouse hepatocytes exposed to the prototypical PPAR α ligand WY-14,643, some genes (ACOX1, ECH1, PEX11A, and ACAA1) were induced in both species, while some (*Ehhadh*, *Pxmp4*, *Acot4*, and *Peci*) were induced only in mouse hepatocytes (Corton et al. 2014). Importantly, PPAR α activators induce large increases in the expression of fatty acyl-CoA oxidase (ACO, which is believed to play a role in oxidative stress-induced liver cancer) in rodent hepatocytes, but relatively weak increases in human hepatocytes (Corton et al. 2014). Other hypothesized explanations for the species difference in response to exogenous PPAR α ligands include variations in the structure of the PPRE that alter the response of the human genes compared with rodents; differences between humans and

2. HEALTH EFFECTS

rodents in the functions of genes under the regulation of PPAR α ; and differences in the ability of ligand-bound human and mouse PPAR α receptor complex to recruit or interact with co-activators (Corton et al. 2014).

PPAR α -Independent or Associative Mechanisms

Experiments using PPAR α -null mice have demonstrated that perfluoroalkyl compounds exert some adverse effects, including developmental and hepatic effects, through mechanisms other than activation of PPAR α . These may include activation of other nuclear receptors, increased oxidative stress, dysregulation of mitochondrial function, and inhibition of GJIC. While some of these effects have been seen after exposure to PPAR α activators (Corton et al. 2014), these mechanisms may also occur independent of PPAR α activation.

Activation of Other Nuclear Receptors. Examination of gene expression changes, as well as studies using other knock-out mice, have shown that some of the PPAR α -independent effects induced by perfluoroalkyl compounds may be mediated by activation of other nuclear receptors, especially PPAR γ , CAR, and ER α . In a series of experiments, Rosen et al. (2008b, 2010, 2017) compared the gene expression changes induced by perfluoroalkyl compounds in wild-type and PPAR α -null mice with gene expression changes induced by known agonists of PPAR γ , CAR, and ER α . Using these data, the study authors estimated the percentage of gene expression changes that were independent of activation of PPAR α , and identified other nuclear receptors potentially involved in the changes induced by the perfluoroalkyls. The results, summarized in Table 2-29, show that between 10 and 24% of gene expression changes induced by perfluoroalkyl compounds are independent of PPAR α . All four compounds tested (PFOA, PFOS, PFNA, and PFHxS) were shown to alter the expression of PPAR γ - and CAR-regulated genes in PPAR α -null mice, and PFNA and PFHxS also altered the expression of ER α -regulated genes in the knock-out mice. In contrast, none of the compounds altered the expression of genes commonly affected by an agonist of LXR in either wild-type or null mice.

2. HEALTH EFFECTS

Table 2-29. Gene Expression Changes Induced by Perfluoroalkyl Compounds

	Dose (mg/kg/day for 7 days)	% PPAR α - independent gene changes	Gene expression changes similar to those induced by prototypical agonist							
			PPAR γ		CAR		ER α		LXR	
			WT	PPAR α - null	WT	PPAR α - null	WT	PPAR α - null	WT	PPAR α - null
PFOA	3	~14	+	+	+	+	+	-	-	-
PFOS	10	~16	+	+	+	+	+	-	-	-
PFNA	1	~10	+	+/-	+	-	+	-	-	-
	3	~17	+	+	+	+	+	+	-	-
PFHxS	3	24	+	-	+	-	+	+	-	-
	10	22	+	+	+	+	+	+	-	-
WY- 14,643	0.1% in diet	2	+	-	-	-	+	-	-	-

+ = significant ($p < 0.0001$) similarity to gene expression changes induced by prototypical receptor agonist as assessed by running Fisher test; CAR = constitutive androstane receptor; ER = estrogen receptor; LXR = liver X receptor; PFHxS = perfluorohexane sulfonic acid; PFNA = perfluorononanoic acid; PFOA = perfluorooctanoic acid; PFOS = perfluorooctane sulfonic acid; PPAR = peroxisome proliferator activated receptor; WT = wild-type

Sources: Rosen et al. 2017, 2008b, 2013; Wolf et al. 2008b

Gene expression changes typical of CAR and PXR activators (phenobarbital and pregnenolone 16 α -carbonitrile [PCN]) were also observed in rat liver after oral exposure to PFOA and PFOS (Ren et al. 2009). In addition, PFDA was shown to activate CAR-dependent genes in a study comparing wild-type and CAR-null mice exposed by intraperitoneal injection (Cheng and Klaassen 2008b).

These data suggest that perfluoroalkyl compounds induce gene expression changes through activation of other nuclear receptors including PPAR γ , CAR, and ER α . Support for these findings are available from *in vitro* studies demonstrating binding and/or transactivation of PPAR γ , CAR, and ER α by perfluoroalkyl compounds. Both PFOA and PFOS activated PPAR γ in cultured human, mouse, and rat hepatocytes, albeit with much lower potency than the known agonist rosiglitazone; neither LXR β nor RXR α was activated in this system (Vanden Heuvel et al. 2006). Zhang et al. (2014) observed binding of PFOA and PFOS to human PPAR γ in transfected *Escherichia coli*. However, in experiments conducted by Takacs and Abbott (2007), neither PFOA nor PFOS activated the mouse or human PPAR γ .

Oxidative Stress. Perfluoroalkyl compounds increase oxidative stress in the liver, kidney, and brain. Increases in oxidative stress may be mediated in part via PPAR α activation, but may also result from activation of the Nrf2 receptor (Xu et al. 2016).

2. HEALTH EFFECTS

Oxidative stress may contribute to oxidative DNA damage, tumor promotion, perturbation of lipid homeostasis, and stimulation of inflammation, among other changes; thus, increases in oxidative stress can have diverse physiological effects. Evidence that perfluoroalkyl compounds increase oxidative stress is available from *in vivo* and *in vitro* studies. For example, oxidative DNA damage (measured as 8-OH-dG levels) was significantly increased in the liver, but not the kidneys, of male rats exposed to PFOA via feed for 2 weeks (Takagi et al. 1991). In HepG2 cells cultured with PFOA or PFOS, significant increases in ROS (measured as 2',7'-dichlorofluorescein diacetate fluorescence) were observed, but there was no evidence of DNA damage measured with the comet assay (Eriksen et al. 2010). In this system, PFNA, PFBS, and PFHxA did not induce ROS production, but a significant increase in DNA damage was seen in cells exposed to PFNA (Eriksen et al. 2010).

In male, but not female, KM mouse pups administered a single subcutaneous injection of PFOS at 1, 2, 3, 4, or 5 weeks of age, brain total antioxidant capacity (T-AOC) was lower than controls at most time points, and significantly decreased after treatment on PND 21 (Liu et al. 2009). In the liver, T-AOC was decreased in male pups treated on PNDs 7 and 14, and in females treated on PND 21. Significant decreases in superoxide dismutase (SOD) activity were noted in the brain of males treated on PNDs 7 and 21, and in the liver of females treated on PND 14. Thus, these data demonstrated increased sensitivity of younger male mouse pups, compared with older pups or female pups, to oxidative damage by PFOS.

Increases in oxidative stress can lead to NFκB activation (Corton et al. 2014). NFκB activation plays a role in tumorigenesis, and NFκB transcription factors coordinate immune responses. Few studies have examined NFκB activation after exposure to perfluoroalkyls. An increase in NFκB mRNA level was seen in the hippocampus of neonatal rats exposed to PFOS *in utero* (Zeng et al. 2011). In addition, NFκB nuclear translocation was accelerated, and NFκB was activated, in breast cancer cells exposed to PFOA (Zhang et al. 2014). The activation of NFκB was associated with increased invasiveness of the breast cancer cells, as coexposure to an inhibitor of NFκB reduced the invasiveness induced by PFOA.

Gap Junction Intercellular Communication (GJIC) Inhibition. Perfluoroalkyl compounds also have been shown to inhibit GJIC both *in vivo* and *in vitro* (Corton et al. 2014). GJIC plays an important role in maintenance of tissue homeostasis, intercellular transmission of regulatory signals, and metabolic cooperation. Disruption of GJIC is thought to be involved in neurological, reproductive, and endocrine abnormalities, as well as in carcinogenesis (Corton et al. 2014; EPA 2016h). There are limited data examining the effects of perfluoroalkyls on GJIC. The available studies showed that both PFOA and PFOS inhibited GJIC in the livers of rats exposed via diet for 1 week or 3 or 21 days, respectively (Hu et

2. HEALTH EFFECTS

al. 2002; Upham et al. 1998, 2009). *In vitro* studies in WB-344 rat liver epithelial cells also showed inhibition of GJIC after exposure to PFOS (Hu et al. 2002) and to perfluorinated fatty acids with 7–10 carbons (Upham et al. 1998, 2009). In this system, PFOA activated extracellular receptor kinase, which may play a role in the inhibition of GJIC. In addition, inhibition of phosphatidylcholine-specific phospholipase C partially mitigated the GJIC inhibition, suggesting that PFOA-induced activation of this enzyme may also be involved in GJIC inhibition (Upham et al. 1998, 2009).

PFOS was also shown to inhibit GJIC in dolphin kidney epithelial cells and rat Sertoli cells *in vitro* (Hu et al. 2002; Wan et al. 2014a). In Sertoli cells, GJIC plays an important role in maintenance of the blood:testes barrier and in intercellular communication during spermatogenesis (EPA 2016i).

Impaired Mitochondrial Function. Mitochondrial function, including cellular respiration as well as mitochondrial membrane potential, has been shown to be perturbed by perfluoroalkyl compounds. Available data suggest that PFOA and PFOS are relatively weak mitochondrial toxicants (EPA 2016h, 2016i). Mitochondrial proliferation was observed in rats exposed orally to PFOA for 28 days and in mice exposed to PFOA during gestation and lactation (Quist et al. 2015a, 2015b; Waters et al. 2009). In isolated rat liver mitochondria, higher concentrations of either PFOA or PFOS were noted to slightly increase resting respiration rate and decrease membrane potential, possibly due to these compounds' effects on membrane fluidity (Starkov and Wallace 2002). Testing of other perfluoroalkyls for effects on mitochondrial respiration rate and oxidative phosphorylation showed a wide range of inhibitory activities, with PFOS demonstrating the highest potency (3-fold higher than PFOA and 20–30-fold higher than PFBuS and PFHxA) (Wallace et al. 2013).

2.20.2 Hepatic Toxicity Mechanisms

Hepatic effects of perfluoroalkyl compounds in rodents likely result from a combination of PPAR α -dependent and independent changes; see Table 2-30. For example, increased liver weight has been observed in both wild-type and PPAR α -null mice orally exposed to PFOA or APFO (Nakagawa et al. 2012; Rosen et al. 2008a), PFOS (Qazi et al. 2009b; Rosen et al. 2010), PFNA (Das et al. 2017; Rosen et al. 2017), or PFHxS (Das et al. 2017; Rosen et al. 2017), but not in null mice exposed to PFBA by intraperitoneal injection (Foreman et al. 2009). Similarly, both wild-type and PPAR α -null mice exposed to APFO exhibited increased hepatocyte vacuolation and proliferation, while exposure to WY-14,643 did not induce such changes in the null mice (Wolf et al. 2008b). Das et al. (2017) showed that PFOA, PFNA, and PFHxS also increased hepatocyte cell size, percent lipid, and hepatic triglyceride levels, and

2. HEALTH EFFECTS

decreased hepatic DNA content, in both wild-type and PPAR α -null mice, while WY-14,643 did not, indicating that these effects were not dependent on PPAR α activation. Similarly, Nakagawa et al. (2012) showed that at a lower APFO dose (1.0 mg/kg/day for 6 weeks), increases in hepatic triglyceride levels were observed in wild-type, PPAR α -null, and humanized PPAR (hPPAR) mouse strains; however, at a higher dose (5 mg/kg/day), hepatic triglyceride levels were still increased in PPAR α -null and hPPAR mice, but decreased in wild-type mice.

Table 2-30. Hepatic Effects of Perfluoroalkyl Compounds in Wild-Type and PPAR α -Null Mice Exposed Orally

	Dose (mg/kg/day)	↑ Relative liver weight		↑ % Lipid by cell area		↑ Hepatic triglycerides		↑ Hepatocyte cell size		↓ Hepatic DNA content	
		WT	PPAR α -null	WT	PPAR α -null	WT	PPAR α -null	WT	PPAR α -null	WT	PPAR α -null
PFOA	3	+++	+++	+++	-	+++	-	+++	+++	+	+
PFOS	10	++	++	ND							
PFNA	1	++	+	ND							
	3	+++	++								
	10	+++	+++	+++	+++	+++	+++	+++	++	+	+
	3	+	+	ND							
PFHxS	10	+++	+++	+++	+++	+++	-	+++	+++	+	+
	50	+++	-	+++	-	-	-	+++	-	+	-

+ = statistically significant change from control (the number of plus signs indicates degree of change from controls); - = not statistically significantly different from control; DNA = deoxyribonucleic acid; ND = no data; PFHxS = perfluorohexane sulfonic acid; PFNA = perfluorononanoic acid; PFOA = perfluorooctanoic acid; PFOS = perfluorooctane sulfonic acid; PPAR = peroxisome proliferator activated receptor; WT = wild type

Sources: Das et al. 2017; Rosen et al. 2008a, 2010, 2017

Lipid homeostasis is maintained through a balance between fatty acid synthesis or accumulation and fatty acid oxidation. Available data indicate that perfluoroalkyl compounds affect both sides of this balance, but a growing body of evidence indicates that fatty acid accumulation induced by perfluoroalkyl compounds tips the balance in favor of hepatic steatosis (Das et al. 2017). As discussed above, perfluoroalkyl compounds alter lipid homeostasis via PPAR α activation, which upregulates genes involved in fatty acid oxidation and reduces lipid levels. However, as noted above, Das et al. (2017) indicate that perfluoroalkyl compounds also perturb lipid homeostasis via PPAR α -independent mechanisms. In addition to the effects noted in Table 2-30, increased incidences of hepatic steatosis were seen in PPAR α -null mice exposed to perfluoroalkyl compounds (Das et al. 2017; Minata et al. 2010; Nakagawa et al. 2012), but not in those exposed to WY-14,643 (Das et al. 2017). Additionally, microvesicular steatosis was observed in hPPAR mice (Nakagawa et al. 2012). The findings are consistent with earlier studies showing triglyceride accumulation in rodent livers after exposure to

2. HEALTH EFFECTS

perfluoroalkyl compounds (Kudo and Kawashima 1997, 2003; Kudo et al. 1999); hepatic steatosis and glucose intolerance in adult rats exposed to PFOS during the prenatal and postnatal periods (Lv et al. 2013); and inhibited hepatic secretion of VLDL, resulting in steatosis, in APOE3-Leiden mice (a rodent model with lipoprotein metabolism similar to humans) exposed to PFOS or PFHxS (Bijland et al. 2011).

Das et al. (2017) investigated whether the steatosis induced by PFOA, PFNA, and PFHxS was mediated by increased fatty acid or triglyceride synthesis or by inhibition of mitochondrial fatty acid transport or β -oxidation. Microarray analysis of mouse liver after exposure to these compounds showed upregulation of genes involved in fatty acid and triglyceride synthesis in both wild-type and PPAR α -null mice. In contrast, *in vitro* experiments demonstrated that these perfluoroalkyl compounds did not affect mitochondrial fatty acid oxidation in isolated rat liver mitochondria, and neither PFOA nor PFOS altered fatty acid oxidation in HepG2/C3A human liver cells. The authors suggested that perfluoroalkyl compounds induce hepatic steatosis by perturbing lipid homeostasis in favor of the accumulation of fatty acids and triglycerides in the liver.

2.20.3 Developmental Toxicity Mechanisms

Developmental effects observed in laboratory rodents exposed to perfluoroalkyl compounds include prenatal loss, reduced neonate weight and viability, neurodevelopment toxicity, and delays in mammary gland differentiation, eye opening, vaginal opening, and first estrus (see Section 2.17 Developmental). During development, PPAR α , PPAR β , and PPAR γ mRNA and protein are expressed in the embryo of rodents and humans (Abbott 2009; Abbott et al. 2010). In humans, the fetal expression levels are equivalent to levels in adult tissues (Abbott et al. 2010). PPAR α activation also appears to be involved in some, but not all, of the developmental effects of perfluoroalkyl compounds in mice, and the role of PPAR α in mediating developmental toxicity differs among the various compounds. For example, a gestational exposure study of PFOA resulted in decreases in postnatal survival in wild-type mice, but not in PPAR α -null mice, while the occurrence of full-litter resorptions was similar between the two genotypes (Abbott 2009; Abbott et al. 2007). In contrast, gestational exposure to PFOS resulted in decreased pup survival in both wild-type and PPAR α -null mice (Abbot et al. 2009). The developmental effects of PFNA, including reduced pup survival and body weight and delayed eye opening, were seen only in wild-type, and not in PPAR α -null mice; however, maternal pregnancy rate was affected only in the null mice (Wolf et al. 2010).

2. HEALTH EFFECTS

Abbott et al. (2012) showed that PFOA altered expression of genes that are involved in homeostatic control of lipids and glucose, and postulated that decreased neonatal survival and body weights may be, in part, due to metabolic disruption. It has been suggested that PFOS interacts with pulmonary surfactants, and that this effect is responsible for neonatal mortality seen in rats. Grasty et al. (2003, 2005) showed that neonatal mortality in PFOS-exposed rats was highest when exposure occurred during the gestational period of lung maturation (GDs 17–20), and that the morphometry of the lungs in exposed neonates was consistent with immaturity. However, treatment of neonates with rescue agents that hasten lung maturation did not prevent neonatal mortality induced by PFOS, and examination of the pulmonary surfactant profile in exposed animals showed no difference from controls, leading Grasty et al. (2005) to conclude that neonatal mortality in neonatal rats exposed to PFOS was not due to immaturity. Other hypotheses pertaining to the mechanisms of developmental toxicity of perfluoroalkyl compounds were not located. However, other molecular- and cellular-level effects of perfluoroalkyl compounds, including increased oxidative stress, dysregulation of mitochondrial function, and receptor-mediated events, may be involved in the observed developmental effects of these compounds.

2.20.4 Immunotoxicity Mechanisms

NTP (2016b) conducted a systematic review of the human, animal, and *in vitro* data examining immunotoxic effects of PFOA and PFOS. The conclusion of the systematic review was that both PFOA and PFOS are “presumed to be immune hazards to humans.” Evidence was considered strong that both compounds were associated with suppression of the antibody response, while there was weaker evidence for PFOA-induced impairment of infectious disease resistance, increased hypersensitivity-related outcomes, and increased autoimmune disease incidence, and for PFOS-induced suppression of natural killer cell activity. A recent study comparing the T-cell dependent antibody response (TDAR) in female wild-type and PPAR α knock-out mice after exposure to PFOA with or without antigen exposure showed that PFOA suppressed TDAR in both wild-type and knock-out mice, indicating that the mechanism for antibody response suppression is independent of PPAR α activation (DeWitt et al. 2016). These investigators observed no treatment-related changes in splenic lymphocyte subpopulations in exposed mice of either genotype, suggesting that PFOA suppressed TDAR via impairment of B-cell/plasma cell function rather than by altering lymphocyte numbers. DeWitt et al. (2012) and Corsini et al. (2014) reviewed mechanistic data for perfluoroalkyl-induced suppression of antibody response, and postulated that perfluoroalkyl compounds may modulate cell-signaling responses critical to antibody production, including c-Jun, NF- κ B, and IL-6.

2. HEALTH EFFECTS

2.20.5 Endocrine Mechanisms

Perfluoroalkyl compounds have been shown to induce alterations in thyroid hormone levels in rats, and associations between serum perfluoroalkyl concentrations and thyroid hormone levels have been reported in human epidemiological studies (see Section 2.13). Few data examining mechanisms of thyroid hormone disruption are available, but suggest that effects of perfluoroalkyl compounds on thyroid function may be mediated by binding to the thyroid hormone receptor, and/or by altering expression of genes involved in thyroid function or thyroid hormone regulation. Several perfluoroalkyl compounds were shown to bind to the human thyroid hormone receptor in cultured GH2 cancer cells and in molecular docking experiments (Ren et al. 2015). In the *in vitro* tests, all 16 of the tested compounds exhibited lower affinity for the receptor than T3 (Ren et al. 2015). Among the tested compounds, PFOS exhibited the strongest agonist activity (Ren et al. 2015). Alterations in the mRNA or protein levels of thyroid-regulating genes have been observed after oral exposure of male Sprague-Dawley rats to PFOS. PFOS exposure for 5 or 90 days resulted in decreased hepatic levels of mRNA type 1 deiodinase (DIO1, which bioactivates T3 by deiodination of T4) (Martin et al. 2007; Yu et al. 2009a); after 5 days of exposure, hepatic mRNA for type 3 deiodinase (DIO3, which inactivates T3) was increased relative to controls (Martin et al. 2007). After 90 days, hepatic levels of uridine diphosphoglucuronosyl transferase 1A1 (UGT1A1, which plays a role in T4 turnover) mRNA and thyroid levels of DOI1 protein were increased, while there were no changes in thyroid levels of the sodium iodide symporter, thyrotropin (THS) receptor, or activity of thyroid peroxidase (Yu et al. 2009a).

Limited data from *in vitro* studies suggest the possibility that perfluoroalkyl compounds may interact with the estrogen and androgen receptors. PFOA, PFOS, PFHxS, PFNA, and PFDeA were all shown to be antagonists of the androgen receptor, while PFOA, PFOS, and PFHxS induced transactivation of the estrogen receptor (Kjeldsen and Bonfeld-Jorgensen 2013). Recently, analysis of gene expression data from the livers of wild-type and PPAR α -null mice exposed to PFOA, PFOS, PFHxS, and PFNA by gavage for 7 days indicated similarities to gene expression changes induced by known ER α agonists (Rosen et al. 2017), providing indirect evidence for perfluoroalkyl changes in the liver mediated via ER activation. However, at oral doses up to 1 mg/kg, PFOA failed to induce treatment-related alterations in uterine weight, ER-dependent gene expression, or morphology of reproductive organs in uterotrophic assays using immature CD-1 mice (Dixon et al. 2012; Yao et al. 2014), suggesting that PFOA is either inactive *in vivo* or of very low estrogenic potency.

2. HEALTH EFFECTS

2.20.6 Cancer Mechanisms

Like many other PPAR α agonists, PFOA induced hepatocellular adenomas, Leydig cell adenomas, and pancreatic acinar cell adenomas in rats (Biegel et al. 2001). Liver tumors induced by PFOA are believed to be mediated largely through PPAR α activation, and considered to be of limited or no relevance to humans (EPA 2016h), based on species differences in response to PPAR α (see details above under PPAR α activation). An expert panel convened by EPA's Science Advisory Board in 2006 to review issues related to the toxicity of PFOA agreed that the weight of evidence supports the hypothesis that induction of liver tumors in rats by PFOA is mediated by a PPAR α agonism mode of action (EPA 2006); this conclusion is also reflected in the EPA Health Effects Support Document for PFOA (EPA 2016h). A recent review by a panel of experts from academia, government, industry, and consulting groups updated the Klaunig et al. (2003) assessment of PPAR α agonism as a liver cancer mode of action, and drew the same conclusion: while the PPAR α mode of action for liver tumors is biologically plausible, species differences in response to PPAR α activation indicate that liver tumors are unlikely to be induced by PPAR α induction in humans (Corton et al. 2014).

Studies conducted in rainbow trout, an animal model that is similar to humans in terms of insensitivity to peroxisome proliferators, suggest that some perfluoroalkyls may induce liver cancer by alternate mechanisms (Benninghoff et al. 2011, 2012). The investigators (Benninghoff et al. 2011) found that PFOA, PFNA, PFDeA, and PFUA were potent inducers of vitellogenin, an estrogen-responsive biomarker protein. *In vitro*, PFOA, PFOS, PFNA, and PFDeA also had weak to very weak affinities for estrogen receptors (ER α) for several species including humans, mice, and rats (Benninghoff et al. 2011). *In vivo* studies demonstrated that PFOA, PFOS, PFNA, and PFDeA enhanced liver carcinogenesis via a mechanism that likely involves interactions with hepatic estrogen receptors (Benninghoff et al. 2012).

Although Leydig cell tumors are commonly induced by peroxisome proliferating agents such as perfluoroalkyl compounds, the mode of action by which these tumors are induced, and thus their relevance to humans, is much less clear (Corton et al. 2014; EPA 2016h; Klaunig et al. 2003). One mode of action proposed for the induction of Leydig cell tumors involves PFOA-induced inhibition of testosterone biosynthesis, leading to increased production of gonadotropin releasing hormone and circulating LH, which promotes Leydig cell proliferation. Activation of PPAR α may be involved in the decreased serum testosterone levels; PPAR α -null mice did not exhibit the reduction in testosterone concentration seen in wild-type mice exposed to PFOA (Li et al. 2011). Evidence of decreased serum testosterone and increased serum estradiol was seen in studies of male rats exposed orally to PFOA for

2. HEALTH EFFECTS

14 days (Biegel et al. 1995; Cook et al. 1992; Liu et al. 1996). Reduced testosterone levels may occur through the conversion of testosterone to estradiol via the enzyme aromatase. Hepatic aromatase activity was shown to be markedly increased in male rats exposed to APFO by gavage for 14 days, and aromatase activity was positively correlated with serum estradiol levels in these animals (Liu et al. 1996). The relevance of Leydig cell tumors induced by PFOA to human risk assessment is uncertain. For example, an intermediate-duration study in *Cynomolgus* monkeys exposed to PFOA did not find treatment-related alterations in serum estradiol, estrone, estriol, or testosterone (Butenhoff et al. 2002). Studies of humans occupationally exposed to PFOA have not consistently reported alterations in estradiol or testosterone levels (Klaunig et al. 2012). In addition, humans are less sensitive than rats to LH stimulation, and the average number of LH receptors per Leydig cell is 13-fold higher in rats than humans (Klaunig et al. 2012). In summary, the induction of Leydig cell tumors by PFOA may be mediated by effects on aromatase activity or testosterone biosynthesis, both of which may be related to PPAR α activation (EPA 2016h). While the relevance of the PPAR α mode of action to humans is uncertain, the data supporting this mode of action for Leydig cell tumors is not sufficient to rule out human relevance (EPA 2016h).

The mechanism of PFOA-induced pancreatic acinar cell tumors has not been elucidated, and relevant data are limited. A proposed mode of action involves stimulation of PPAR α leading to reduced bile flow and/or changes in bile acid composition with subsequent increase in cholecystokinin (CCK), which stimulates pancreatic cell proliferation and tumor formation (EPA 2016h). Effects on bile acid composition induced by PFOA may be mediated by effects on bile acid transporters. PFOA exposure has been shown to decrease expression of OATPs and increase expression of MRP3 and MRP4 (Cheng and Klassen 2008a; Maher et al. 2008). In a study using wild-type and PPAR α -null mice, increased biliary excretion of PFOA was seen in wild-type mice compared with null mice, and biliary excretion of bile acids was highest in the null mice (Minata et al. 2010). These observations suggest the possibility that increased excretion of PFOA could diminish the excretion of bile acids that require the same transporters. However, given the limitations in available data, information is insufficient to fully characterize the mode of action for PFOA-induced pancreatic tumors (EPA 2016e).

2.21 GENOTOXICITY

No studies of genotoxicity in humans exposed to perfluoroalkyl compounds were located.

Administration of a single intraperitoneal injection of 100 mg/kg PFOA to male Fischer-344 rats resulted in a significant increase in the levels of 8-hydroxydeoxyguanosine (a marker of oxidative DNA damage)

2. HEALTH EFFECTS

in liver DNA, but not in kidney DNA; the same dose of PFBA had no effect on liver or kidney DNA (Takagi et al. 1991). Oral administration of approximately 20 mg/kg/day PFOA or 10 mg/kg/day PFDeA in the diet for 2 weeks to male Fischer-344 rats induced hepatomegaly and also increased the levels of 8-hydroxydeoxyguanosine in liver DNA but not in kidney DNA (Takagi et al. 1991). These findings led the authors to conclude that induction of peroxisome proliferation also leads to organ-specific oxidative DNA damage. Unpublished studies summarized by Butenhoff et al. (2014) and Kennedy et al. (2004) did not find increases in the occurrence of polychromatic erythrocytes in the bone marrow of mice orally exposed to PFOA. PFOS induced micronuclei frequency and decreased the ratio of polychromatic erythrocytes to normochromatic erythrocytes in bone marrow of rats following oral exposure to 0.6–2.5 mg/kg for 30 days (Celik et al. 2013; Eke and Celik 2016).

In vitro studies provide evidence that PFOA and PFOS are not mutagenic at noncytotoxic concentrations. Butenhoff et al. (2014) and Kennedy et al. (2004) summarized the results of various unpublished mutagenicity studies with PFOA. Negative results were found in reverse mutation assays using *Salmonella typhimurium* (strains TA98, TA100, TA1535, TA1537, and TA1538), *Saccharomyces cerevisiae*, and *Escherichia coli* (WP2uvrA strain) with or without metabolic activation. In mammalian cells, PFOA was negative for forward mutations using Chinese hamster ovary cells, for chromosomal aberrations in Chinese hamster ovary cells and human lymphocytes, and for cell transformation in C3H 10T1/2 cells. Similarly, two *in vivo* assays found no alterations in the occurrence of micronuclei in mice. PFOA also was not mutagenic in *S. typhimurium* TA1535/pSK1002 (*hisG46*, *rfa*, *uvrB*) with or without metabolic activation using the *umu* test (Oda et al. 2007) or in *S. typhimurium* TA98, TA100, TA102, and TA104 strains with or without metabolic activation using an Ames assay (Fernández Freire et al. 2008).

Incubation of human hepatoma HepG2 cells with 50–400 μ M PFOA caused DNA strand breaks and 100–400 μ M increased the incidence of micronuclei, in a dose-related manner in both cases (Yao and Zhong 2005). These effects were accompanied by a significant increase in reactive oxygen species (ROS), which the investigators suggested caused the DNA damage. Bjork and Wallace (2009) measured mRNA expression for DNA damage inducible *Ddit3* to assess DNA damage in primary rat and human hepatocyte cultures and in HepG2/C3a hepatoma cells. Significant increases in mRNA transcription for *Ddit3* were found in primary rat hepatocytes at 100 μ M PFOA and in primary human hepatocytes and HepG2/C3a hepatoma cells at 200 μ M PFOA. Although both studies provide evidence of DNA damage, the tested concentrations were very high as compared to what could be expected to occur in the environment. A significant increase in mutation frequencies was observed in hamster-human hybrid cells exposed to 200 μ M PFOA for 1–16 days; a 79% decrease in cell viability was also observed at this concentration

2. HEALTH EFFECTS

(Zhao et al. 2011). Concurrent treatment with a ROS inhibitor significantly decreased the mutagenic potential, indicating that ROS may play an important role in mediating the genotoxic effects of PFOA. PFOA induced DNA damage in *Paramecium caudatum* following exposure to 100 μM for 12 and 24 hours (Kawamoto et al. 2010). Intracellular ROS was significantly increased and DNA damage was not reversed by the application of glutathione, a ROS-inhibitor, indicating that intracellular ROS may not be the cause of PFOA-induced DNA damage. PFOS did not induce DNA damage in this study. In contrast, no increases in DNA damage or micronuclei formation were found in human hepatoma HepG2 cells following a 24-hour exposure to PFOA concentrations as high as 800 μM (Florentin et al. 2011); cytotoxicity was observed at ≥ 200 μM . Eriksen et al. (2010) also found no evidence of DNA damage in HepG2 cells incubated with 100 or 400 μM PFOA for 24 hours.

OECD (2002) summarized unpublished mutagenicity studies conducted with PFOS. PFOS was negative in all tested assays. It did not induce reverse mutations in *S. typhimurium* or *E. coli* with or without metabolic activation. A study published after this review also found that PFOS was not mutagenic in *S. typhimurium* TA1535/pSK1002 (*hisG46*, *rfa*, *uvrB*) with or without metabolic activation using the *umu* test (Oda et al. 2007). As summarized by OECD (2002), PFOS did not induce chromosomal aberrations in human lymphocytes with or without metabolic activation and did not induce unscheduled DNA synthesis in primary cultures of rat hepatocytes. In addition, PFOS did not induce micronuclei in the bone marrow of CD-1 mice in an *in vivo* assay. PFOS did not result in DNA damage in Syrian hamster embryo cells at concentrations up to 50 $\mu\text{g/mL}$, but did induce cell transformation at noncytotoxic concentrations (0.2 and 2 $\mu\text{g/mL}$) following 5 and 24 hours of exposure (Jacquet et al. 2012). Similarly, PFOS did not induce DNA damage or micronuclei formation in human hepatoma HepG2 cells following a 24-hour exposure to PFOA concentrations as high as 600 μM ; cytotoxicity was observed at ≥ 300 μM (Florentin et al. 2011). Another study of with HepG2 cells did not find evidence of DNA damage at concentrations of 100 and 400 μM PFOS (Eriksen et al. 2010).

Limited *in vitro* data on the genotoxicity of other perfluoroalkyls were located. No DNA damage was found in HepG2 cells incubated with 100 or 400 μM PFHxS or PFBuS for 24 hours (Eriksen et al. 2010). A “modest” increase in DNA damage was observed at 400 μM PFNA, a cytotoxic concentration (Eriksen et al. 2010).

CHAPTER 3. TOXICOKINETICS, SUSCEPTIBLE POPULATIONS, BIOMARKERS, CHEMICAL INTERACTIONS

3.1 TOXICOKINETICS

Toxicokinetic data on perfluoroalkyls examined in this profile are available from studies in humans and animals. Most studies in animals administered perfluoroalkyls by the oral route. These data are briefly summarized below.

- Absorption
 - Perfluoroalkyls are absorbed following oral, inhalation, and dermal exposure.
 - Quantitative estimates of the fractional absorption of orally administered perfluoroalkyls in animals range from >50% for PFHxS to >95% for PFOA, PFBA, PFNA, PFDeA, PFUA, and PFDoA.
 - No quantitative estimates of the fractional absorption of perfluoroalkyls following inhalation or dermal exposure were identified.
- Distribution
 - Perfluoroalkyls are widely distributed in the body, with the highest concentrations in the liver, kidneys, and blood.
 - In the blood, perfluoroalkyls bind to albumin and other proteins.
 - Perfluoroalkyls can be transferred to the fetus during pregnancy and to nursing infants.
- Metabolism
 - Results of available oral and *in vitro* studies suggest that perfluoroalkyls are not metabolized and do not undergo chemical reactions in the body.
 - Although no studies examining metabolism of perfluoroalkyls following inhalation or dermal exposure were identified, metabolism by these exposure routes is not expected.
- Excretion
 - Studies of elimination rates (i.e., half-lives) of perfluoroalkyls show that elimination $t_{1/2}$ values are similar following intravenous, intraperitoneal, and oral exposures. Findings suggest that route of absorption has no substantial effect on rates of elimination of absorbed perfluoroalkyls.
 - Perfluoroalkyls are primarily eliminated in the urine, with smaller amounts eliminated in feces and breast milk.

3. TOXICOKINETICS, SUSCEPTIBLE POPULATIONS, BIOMARKERS, CHEMICAL INTERACTIONS

- Perfluoroalkyls undergo biliary excretion, but substantial reabsorption occurs; therefore, biliary excretion is not a major elimination pathway.
- Rates of elimination of perfluoroalkyls vary substantially across chemical species and animal species, and show sex differences and age-dependencies within certain species.
- In general, perfluoroalkyl sulfonates are eliminated more slowly than perfluoroalkyl carboxylates; elimination rate decreases with increasing chain length, and increases with increased branching.
- In humans, estimates for elimination $t_{1/2}$ range from hours (PFBA: 72–81 hours) to several years (PFOA: 2.1–8.5 years; PFOS: 3.1–7.4 years; PFHxS: 4.7–15.5 years).
- Evidence for sex differences in elimination of perfluoroalkyls in humans is not as strong as in rats. Menstruation may contribute to faster elimination of PFOS in younger women (≤ 50 years) women compared to men and older women.

3.1.1 Absorption

Inhalation Exposure. Studies of the absorption of perfluoroalkyls in humans following inhalation exposure were not located; elevated serum concentrations of perfluoroalkyls in workers in fluorochemical production industry have been reported (see Table 5-22), indicating that perfluoroalkyls are absorbed following inhalation exposure. Occupational exposures in these workers are likely to have included inhalation of aerosols of perfluoroalkyls complexed with airborne dusts. Higher serum levels in workers compared to the general population (see Table 5-20) probably reflects a predominant contribution from inhaled perfluoroalkyls.

Studies conducted in rodents provide direct evidence for absorption of inhaled perfluoroalkyls. PFOA was detected in plasma of rats within 30 minutes of initiating nose-only exposures to aerosols (mass median aerodynamic diameter [MMAD]=1.9–2.1 μm) of 1–25 mg ammonium PFOA/ m^3 . Plasma concentrations increased during the 6-hour exposure, with the highest concentrations observed at 9 hours (3 hours after cessation of exposure) in male rats and at 7 hours (1 hour after cessation of exposure) in females (Hinderliter et al. 2006a). Assuming an elimination $t_{1/2}$ of absorbed PFOA of approximately 160 hours in male rats, a peak plasma concentration at 9 hours would correspond to an absorption $t_{1/2}$ of approximately 1.3 hours (see discussion below, Equations 3-1 and 3-2). The earlier time of highest plasma concentration observed in female rats appears to be associated with faster elimination of absorbed PFOA in female rats, compared to male rats (see Section 3.1.4).

3. TOXICOKINETICS, SUSCEPTIBLE POPULATIONS, BIOMARKERS, CHEMICAL INTERACTIONS

Nose-only exposure of male rats to dusts of ammonium perfluorononanoate induced significant increases in absolute and relative liver weight, assessed 5 and 12 days after exposure, providing indirect evidence of absorption of this compound through the respiratory airways (Kinney et al. 1989).

Oral Exposure. Studies of absorption of perfluoroalkyls through the gastrointestinal tract in humans are not available. A study of the general population of Europe and North America estimated that the greatest portion of the chronic exposure to PFOS and PFOA results from the intake of contaminated food, including drinking water (Trudel et al. 2008). Direct evidence of oral absorption of perfluoroalkyl compounds was provided in studies that found associations between environmental levels (e.g., drinking water) and perfluoroalkyl concentrations in human serum (Emmett et al. 2006a; Hoffman et al. 2011; Hölzer et al. 2008; Seals et al. 2011; Wilhelm et al. 2008) and by reductions in serum levels after exposures from water were eliminated or reduced (Bartell et al. 2010; Emmett et al. 2009).

Animal data provide quantitative estimates of the fractional absorption of orally administered PFOA, PFOS, PFBA, and PFHxS, PFHpA, PFNA, PFDeA, PFUA, and PFDoA, with estimates ranging from >50% for PFHxS to >95% for PFOA, PFBA, PFNA, PFDeA, PFUA, and PFDoA. Greater than 95% of an oral dose of ammonium [¹⁴C]PFOA was absorbed in rats that received single gavage doses ranging from 0.1 to 25 mg/kg (Kemper 2003). In male and female mice, comparison of the 24-hour area under the curve (AUC) for oral and intravenous administration showed that 90–100% of the oral dose was absorbed for PFOA (females), PFNA (males and female), PFDeA (males and females), PFUA (males and females), and PFDoA (males and female); however, absorption of PFOA in males was 80%, compared to 100% in females (Fujii et al. 2015a, 2015b). Based on comparison of the AUC for oral and intravenous administration, the estimated oral absorption fractions were 50% in female rats administered a single 10 mg/kg dose of potassium [¹⁸O₃]PFHxS (Sundström et al. 2012) and 79 and 55% in male and female rats administered a single dose of 4 mg/kg sodium [¹⁸O₃]PFHxS (Kim et al. 2016b). Sundström et al. (2012) stated that this estimate may not be reliable due to the short (24 hours) observation period. A comparison of ¹⁴C disposition in rats, mice, hamsters, and rabbits following an oral dose of 10 mg ammonium [¹⁴C]PFOA/kg showed that similar fractions of the dose were absorbed (Hundley et al. 2006). The estimated absorbed fractions (i.e., ¹⁴C in tissues, urine, and exhaled air measured 120–168 hours after the dose) in males were 89% in rats, 82% in mice, 92% in hamsters, and 88% in rabbits. Corresponding values for females were 76% in rats, 61%, in mice, 75% in hamsters, and 88% in rabbits. These estimates exclude ¹⁴C excreted in feces, which may have been absorbed and secreted in bile before excretion (see Section 3.1.4). Fasting appears to increase absorption of PFOA. Plasma PFOA concentrations in rats, 24 hours following a gavage dose of 10 mg ammonium PFOA/kg, were 2–3 times higher when

3. TOXICOKINETICS, SUSCEPTIBLE POPULATIONS, BIOMARKERS, CHEMICAL INTERACTIONS

administered to fasted rats, compared to fed rats (Hinderliter et al. 2006b). The estimated absorption fractions of ingested ammonium [^{14}C]PFOA or potassium [^{14}C]PFOS (administered as a 4.2 mg/kg oral dose) were >93 and >95% in rats, respectively (Johnson and Ober 1979, 1999a). Based on combined urinary excretion and retention in the carcass (excluding the gastrointestinal tract and its contents), the estimated oral absorption fraction of [^{14}C]PFOS (administered as a single 4.2 mg/kg dose of potassium [^{14}C]PFOS) in male rats was >95% (Chang et al. 2012). The estimated absorption fraction of PFBA (administered as 30 mg/kg oral dose of PFBA) was >95% in rats (Chang et al. 2008a). Cumulative excretion of PFBA 24 hours after an oral dose (administered as 10, 30, or 100 mg/kg ammonium PFBA) was approximately 35% in urine and 4–11% in feces in male mice; and 65–69% in urine, and 5–7% in feces in female mice (Chang et al. 2008a).

Studies examining the rate of absorption of PFOA, PFBA, and PFBS show rapid absorption from the gastrointestinal tract, with values for absorption $t_{1/2}$ of <2 hours. For PFOA, the highest observed concentrations of ^{14}C in plasma occurred in male rats at approximately 10 hours (range 7.5–15 hours) following single oral doses ranging from 0.1 to 25 mg ammonium PFOA/kg (Kemper 2003). The elimination $t_{1/2}$ of ^{14}C in plasma estimated in these same animals was approximately 170 hours (range 138–202 hours), corresponding to an elimination rate constant (k_e) of 0.0044 hour^{-1} (range 0.004–0.005 hour^{-1}). The corresponding absorption $t_{1/2}$ of approximately 1.5 hours ($k_a=0.45 \text{ hour}^{-1}$) can be calculated from these observations (Equations 3-1 and 3-2):

$$t_{\max} = \ln \frac{k_a}{k_e} \cdot \frac{1}{(k_a - k_e)} \quad \text{Eq. (3-1)}$$

$$t_{1/2} = \frac{\ln(2)}{k_e} \quad \text{Eq. (3-2)}$$

Where t_{\max} = time of maximum concentration of ^{14}C ; k_e = elimination rate constant; and k_a = absorption constant. The absorption rate of PFOA appears to be greater in female rats compared to male rats. The time to peak concentrations of ^{14}C in plasma occurred at approximately 1.1 hour (range 0.6–1.5 hours) in female rats and 10 hours (range 7–15 hours) in male rats following single oral doses ranging from 0.1 to 25 mg ammonium PFOA/kg (Kemper 2003). The elimination $t_{1/2}$ of ^{14}C in plasma estimated in these same animals varied with dose and ranged from 3.2 hours at the lowest dose ($k_e=0.23 \text{ hour}^{-1}$) to 16.2 hours at the highest dose ($k_e=0.059 \text{ hour}^{-1}$). The estimated absorption $t_{1/2}$ from the observations made at all doses (0.1, 1, 5, and 25 mg/kg), based on Equations 3-1 and 3-2, was approximately 0.25 hours (range 0.12–0.38 hours). The absorption $t_{1/2}$ of PFBA in male and female rats following administration of a single oral dose (30 mg/kg ammonium PFBA) was 0.23 hours (3.04 hour^{-1}) in males and 0.17 hours (4.15 hour^{-1}) in females (Chang et al. 2008a). In male and female mice administered 10–

3. TOXICOKINETICS, SUSCEPTIBLE POPULATIONS, BIOMARKERS, CHEMICAL INTERACTIONS

30 mg/kg ammonium PFBA, the absorption $t_{1/2}$ was <1 hour, although the absorption rate may be dose-dependent in males, with higher absorption $t_{1/2}$ at doses >30 mg/kg (Chang et al. 2008a). Similar results were reported by Olsen et al. (2009) based on estimated compartmental pharmacokinetic parameters for PFBuS in serum of male and female rats following a single intravenous or gavage dose of 30 mg potassium PFBuS. Plasma concentration-time profiles were fit to a two-compartment elimination model. The absorption $t_{1/2}$ can be approximated from these data using Equation 3-1, with the elimination rate constant represented by the fast-phase elimination rate constant estimated for either the oral or intravenous dose. Using the oral or intravenous parameters yield similar values for the absorption $t_{1/2}$ (0.12–0.16 hours). The estimated t_{max} values following the gavage dose were 0.42 hours in males and 0.33 hours in females. The fast-phase elimination rate constants following the gavage dose were 0.892 hours⁻¹ ($t_{1/2}$ =0.79 hours) in males and 1.308 hours⁻¹ ($t_{1/2}$ =0.53 hours) in females. The corresponding values for absorption $t_{1/2}$ were 0.14 hours (k_a =5.0 hours⁻¹) in males and 0.12 hours (k_a =5.8 hours⁻¹) in females. Use of the fast-phase elimination rate constants estimated following intravenous administration (male: 1.143 hours⁻¹; female: 1.956 hours⁻¹) yielded values for the absorption $t_{1/2}$ of 0.16 hours in males (k_a =4.30 hours⁻¹) and females (k_a =4.45 hours⁻¹).

Mechanisms of oral absorption of perfluoroalkyls have not been elucidated.

Dermal Exposure. Dermal exposures of rats to ammonium PFOA have been shown to produce systemic (e.g., liver, immunotoxicity) toxicity in animals (see Chapter 2). Estimates of the amount or rates of dermal absorption in humans or animals have not been reported. PFOA was detected in serum of mice following dermal application of PFOA dissolved in acetone (Franko et al. 2012). The investigators noted PFOA ingestion may have occurred during grooming and may have contributed to the body burden. Dermal absorption of PFOS was assessed following application of single doses of potassium PFOS (doses up to 0.30 mg/kg) and the diethanolamine salt of PFOS (doses up to 20 µg/kg) to clipped, intact skin of rabbits (Johnson 1995a, 1995b). Analysis of the liver 28 days after application showed no increase in content of total organic fluoride compared to controls, indicating that dermal absorption was not detectable at low dose levels using this methodology. Dermal penetration of PFOA has been studied in preparations of isolated rat, mouse, and human epidermis (Fasano et al. 2005; Franko et al. 2012). These studies indicate that the rat and mouse skin may be more permeable to PFOA than human skin. Approximately 24% of a dermal dose of PFOA (0.5 mg in 1% acetone) was absorbed across isolated full thickness human skin in 24 hours and 45% of the dose was retained in skin (Franko et al. 2012); it is noted that the acetone, as well as the glycerol used to pretreat the skin may have enhanced PFOA absorption. Permeability was sensitive to pH and was higher when the skin was buffered at pH 2.5

3. TOXICOKINETICS, SUSCEPTIBLE POPULATIONS, BIOMARKERS, CHEMICAL INTERACTIONS

(5.5×10^{-2} cm/hour) compared to pH 5.5 (4.4×10^{-5} cm/hour), well above the pKa for the terminal carboxylic acid of PFOA (Franko et al. 2012). This suggests that permeability of the unionized acid is greater than that of the dissociated anion. Lower permeability of ionized PFOA is also suggested by relatively low permeability of the ammonium salt of PFOA in isolated preparations of rat and human skin. Following application of the ammonium salt of PFOA to isolated human or rat epidermis ($150 \mu\text{L}/\text{cm}^2$ of a 20% aqueous solution of ammonium PFOA; approximately 30 mg ammonium PFOA/ cm^2), approximately 0.048% of the dose was absorbed across human epidermis and 1.44% was absorbed across rat epidermis in 40 hours. The estimated dermal penetration coefficients were 9.49×10^{-7} cm/hour in the isolated human epidermis and 3.25×10^{-5} cm/hour in the isolated rat epidermis.

3.1.2 Distribution

Available information on the distribution of perfluoroalkyls is obtained from oral exposure studies in laboratory animals and occupational exposure studies in which exposure is predominantly by inhalation. Studies specifically examining the distribution of perfluoroalkyls by inhalation or dermal exposure were not identified. As discussed in Section 3.1.3 (Metabolism), perfluoroalkyls do not undergo metabolism. Therefore, distribution is expected to be the same regardless of the route of administration.

Distribution in Blood. In a study of perfluoroalkyl workers, serum:plasma ratios for PFHxS, PFOS, and PFOA were 1:1, and this ratio was independent of the concentrations measured (Ehresman et al. 2007). The ratio of whole blood:plasma (or serum) was approximately one-half, which corresponded to volume displacement by red blood cells, suggesting that these perfluoroalkyls do not enter cellular components of blood. In studies conducted in animals, most of the PFOA in blood is in the plasma fraction. In rats, 24 or 48 hours following an oral dose of 11.4 mg ammonium [^{14}C]PFOA/kg, the red blood cell:plasma PFOA concentration ratio ranged from 0.2 to 0.3, suggesting that there was no selective retention of PFOA by red blood cells (Johnson and Ober 1999a). Blood:plasma (or serum) ratios of approximately 0.5 have also been observed in rats following intravenous injection of PFOA (Kudo et al. 2007).

Perfluoroalkyls in plasma bind to serum albumin. The dissociation constant for binding of PFOA to serum albumin is approximately 0.4 mM (0.38 mM, ± 0.04 standard deviation [SD] for human serum albumin; 0.36 nM, ± 0.08 SD for rat serum albumin) and involves 6–9 binding sites (Han et al. 2003). Given a dissociation constant (K_D) of 0.4 mM and an albumin concentration of approximately 0.6 mM, >90% of PFOA in serum would be expected to be bound to albumin when the serum concentration of PFOA is <1 mM (<440 mg/L). This is consistent with observations of the bound fraction of

3. TOXICOKINETICS, SUSCEPTIBLE POPULATIONS, BIOMARKERS, CHEMICAL INTERACTIONS

perfluoroalkyls in plasma of rats that received a gavage dose of 25 mg PFOA/kg (Han et al. 2003, 2005; Ylinen and Auriola 1990), and in human, rat, and monkey plasma incubated *in vitro* with perfluoroalkyls (e.g., PFHxA, PFOA, PFOS, PFNA, PFDeA) (Ohmori et al. 2003; Kerstner-Wood et al. 2003).

Comparison of dissociation constants for binding of PFOA and PFOS to human serum albumin indicates that PFOS (K_D : 8×10^{-8}) has a higher binding affinity than PFOA (K_D : 1×10^{-4}) for albumin, consistent with the longer $t_{1/2}$ of PFOS versus PFOA in humans (Beesoon and Martin 2015; see section 3.1.4 for additional information). PFOS has also been shown to bind to human hemoglobin *in vitro* (Wang et al. 2016). PFBuS was found to bind only to albumin, whereas PFOS, PFOA, and PFHxS were found to have the potential to bind to other human serum binding proteins, including plasma gamma-globulin, alpha-globulin, alpha-2-macroglobulin, transferrin, and beta-lipoproteins (Kerstner-Wood et al. 2003).

Distribution to Extravascular Tissues. Absorbed perfluoroalkyls distribute from plasma to soft tissues, with the highest extravascular concentrations achieved in liver. An analysis of samples from human cadavers attempted to quantify PFOA, PFOS, PFOSA, and PFHxA concentrations in serum and liver (Olsen et al. 2003c). The route of exposure was unknown. Mean serum PFOS concentration was 17.7 ng/mL (95% CI 13.0–22.5, range of <6.9 [limit of quantification] to 57 ng/mL, n=24) and was not different in males (18.2 ng/mL, n=13) and females (17.2 ng/mL, n=11). The mean liver concentration was 18.8 ng/g (95% CI 14.1–23.5; range <7.3–53.8 ng/g, n=30). The mean liver:serum concentration ratio was 1.3 (95% CI 0.9–1.7, n=23) and was not different in males (1.3, n=13) and females (1.3, n=10). Most liver and serum concentrations for PFOA, PFOSA, and PFHxA were below the limit of quantification; these limits were <17.9–<35.9 ng/mL for PFOA, <7.5–<19.6 ng/g for PFOSA, and <3.4–<18.5 ng/mL for PFHxA.

Studies conducted in nonhuman primates and rodents have provided additional information on the distribution of absorbed perfluoroalkyls to extravascular tissues. Distribution, as assessed from tissue perfluoroalkyl concentrations and tissue:serum ratios, exhibits profound species and sex differences as well as dose-dependencies (e.g., tissue levels that change disproportionately with dose). These differences have been attributed, in part, to species and sex differences in elimination kinetics of absorbed perfluoroalkyls and dose-dependence of elimination kinetics (see Section 3.1.4). In general, a consistent finding across species is that the liver receives a relatively high fraction of the absorbed dose and may also experience relatively high tissue concentrations compared with other tissues, with blood (i.e., plasma) and kidney also showing relatively high concentrations. The most extensive investigations of tissue distribution have been conducted in rodents.

3. TOXICOKINETICS, SUSCEPTIBLE POPULATIONS, BIOMARKERS, CHEMICAL INTERACTIONS

Bogdanska et al. (2011) examined distribution of ^{35}S following dietary exposure to adult male C57/BL6 mice to low (environmentally relevant; 0.031 mg/kg/day) and high (experimentally relevant; 23 mg/kg/day) doses of [^{35}S]PFOS for 1–5 days. For both low and high doses after 1, 3, and 5 days of exposure, ^{35}S was distributed to the following tissues: blood, liver, lung, kidney, skin, whole bone, pancreas, spleen, thymus, heart, testes, epididymal fat, fat pads, brain, and muscle; ^{35}S was also detected in tissues throughout the gastrointestinal tract. Similar tissue:blood ratios were observed in both dose groups. In low-dose animals after 5 days of treatment, the highest tissue concentrations (excluding the gastrointestinal tract) were liver (tissue:blood=5.8), followed by lung (tissue:blood=1.4), whole bone, including marrow (tissue:blood=1.1), blood, and kidney (tissue:blood=0.94). In high-dose animals, the highest tissue concentrations were liver (tissue:blood=3.6), followed by lung (tissue:blood=1.6), blood, kidney (tissue:blood=0.81), and whole bone, including marrow (tissue:blood=0.72). A similar pattern of distribution was observed following intravenous administration of [^{14}C]potassium PFOS (4.2 mg/kg) to male rats (Johnson and Ober 1980). For both dose groups, the tissue:blood ratios for all other tissues were <1. In male and female CD-1 mice administered a single oral dose (4.2 mg/kg) of [^{14}C]PFOS, the highest concentrations of ^{14}C was observed in the liver, followed by serum, and then kidney, with similar tissue levels observed in males and females (Chang et al. 2012). In male and female rats fed diets containing 0, 2, 20, 50, or 100 mg/kg [^{13}C]sodium PFOS (equivalent to 0, 0.14, 1.33, 3.21, and 6.34 and 0, 0.15, 1.43, 3.73, and 7.58 mg/kg/day in males and females, respectively) for 28 days, PFOS levels were highest in liver, followed by spleen, heart, and serum. Liver:serum ratios for the 2, 20, 50, and 100 mg/kg/day diets were approximately 52, 42, 41, and 35, respectively, in males and 30, 47, 20, and 23, respectively, in females (Curran et al. 2008). Except for rats fed diets containing 20 mg/kg, the liver:serum ratio in males was higher than in females. No additional data were reported to determine if PFOS distribution differed between male and female rats.

Kemper (2003) determined the distribution of ^{14}C in male and female rats at the approximate time of maximum plasma concentration in both sexes, following single gavage doses of [^{14}C]PFOA (as ammonium PFOA, 0.1–25 mg/kg). This design allows a more direct comparison of patterns of tissue distribution in male and female rats at similar plasma concentrations, even though the elimination kinetics in the female rat are substantially faster than in male rats (see Section 3.1.4). The highest concentrations of ^{14}C were observed in blood, liver, and kidney (Figure 3-1). Liver, blood, and kidney accounted for approximately 22, 22, and 2% of the administered dose of 1 mg/kg in male rats; and 6, 7, and, 3% in female rats (the sex difference reflected more rapid excretory elimination in females). Although blood, liver, and kidney concentrations appeared to increase proportionately with increasing dose in male rats, in female rats, a disproportionately higher concentration in kidney was observed following the 25 mg/kg dose

3. TOXICOKINETICS, SUSCEPTIBLE POPULATIONS, BIOMARKERS, CHEMICAL INTERACTIONS

(Figure 3-1). Concentrations in other tissues ranged from 0.1 to 0.25 of that in liver or kidney; concentrations in bone and fat were <0.1 of that in liver or kidney. Profound sex differences and dose-dependencies in tissue concentrations of PFOA were also observed in rats that received oral doses of PFOA for 28 days at doses of 3, 10, or 30 mg PFOA/kg/day (Ylinen et al. 1990; Figure 3-2). Mean serum, kidney, or liver concentrations did not increase proportionally with dose in either sex. Kidney concentrations exhibited a disproportionate increase as the dose increased from 3 to 10 mg/kg/day, with little further increase at the 30 mg/kg/day dose. Sex differences in tissue distribution of PFOA in rats are not explained by sex differences in bioavailability since the differences persist in animals that received parenteral doses of PFOA (Johnson and Ober 1999b; Vanden Heuvel et al. 1991b, 1991c). The differences have been attributed to more rapid elimination of PFOA in female rats, compared to male rats (see Section 3.1.4).

Figure 3-1. Tissue Concentrations of ^{14}C in Male and Female Rats Following a Single Gavage Dose of [^{14}C]PFOA at 1, 5, or 25 mg/kg*

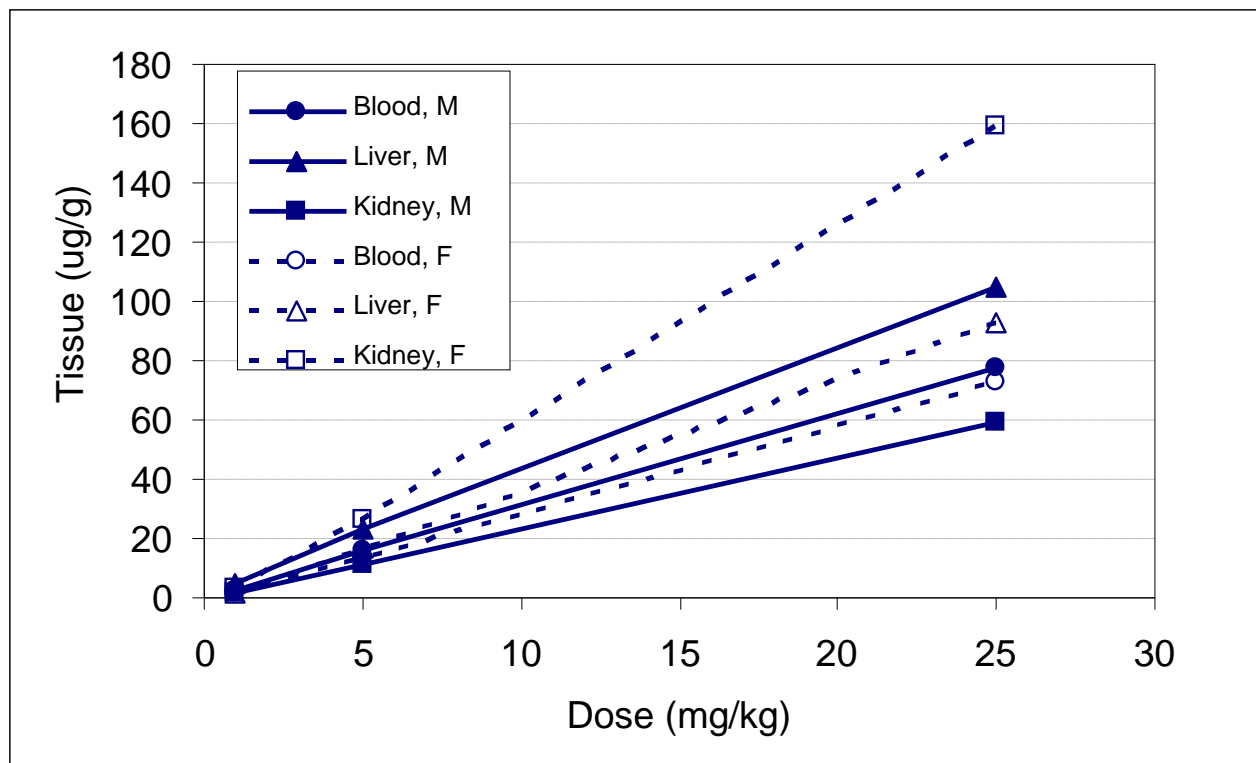

*Tissue levels are measured at time of maximum concentration in each tissue.

Source: Kemper 2003

3. TOXICOKINETICS, SUSCEPTIBLE POPULATIONS, BIOMARKERS, CHEMICAL INTERACTIONS

Figure 3-2. Tissue Concentrations of ¹⁴C in Male (Upper Panel) and Female (Lower Panel) Rats Following Oral Doses of PFOA for 28 Days at Doses of 3, 10, or 30 mg/kg/day

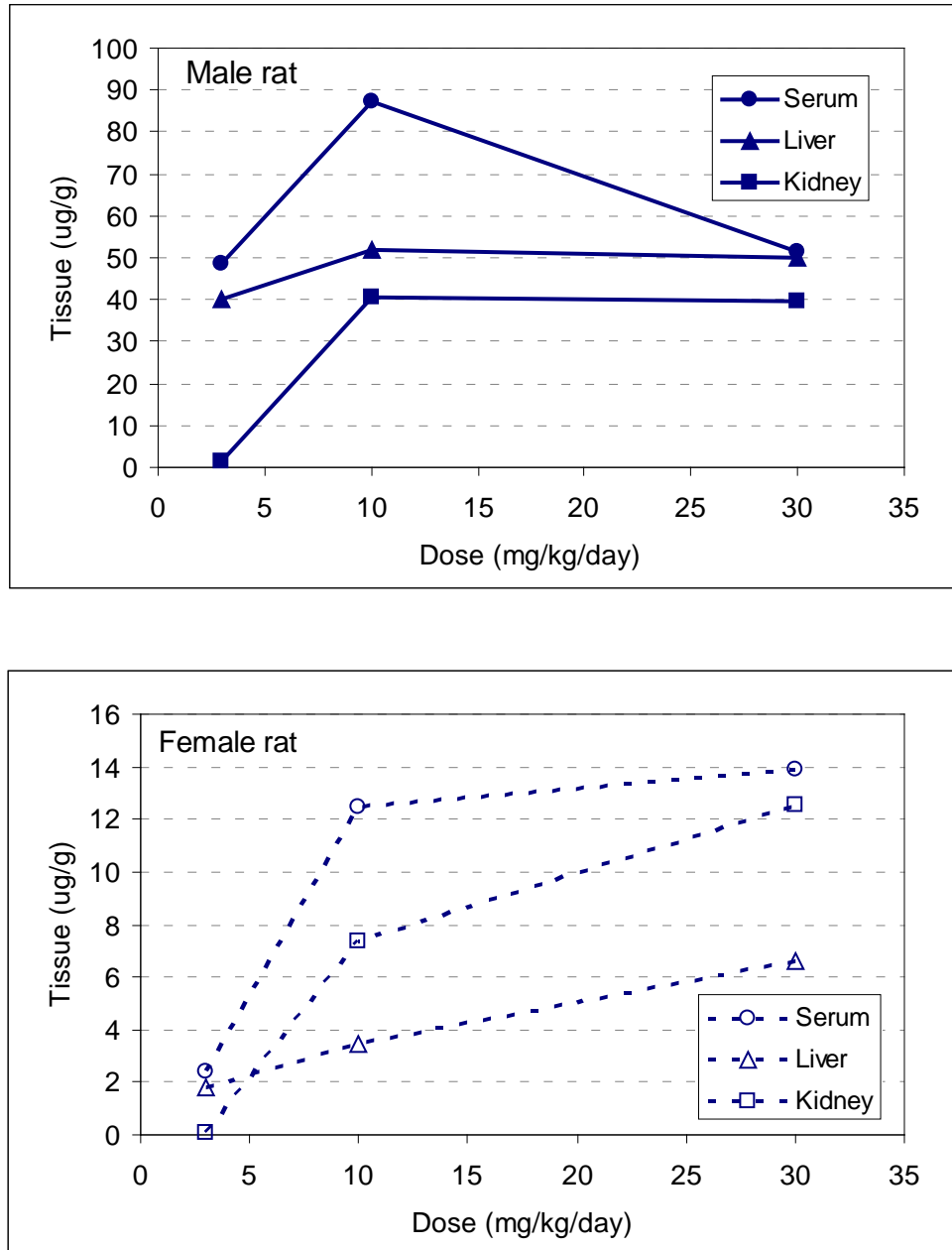

Source: Ylinen et al. 1990

3. TOXICOKINETICS, SUSCEPTIBLE POPULATIONS, BIOMARKERS, CHEMICAL INTERACTIONS

A comparison of PFOA disposition in rats, mice, hamsters, and rabbits showed pronounced species and sex differences (Hundley et al. 2006; Table 3-1). In this study, rats, mice, hamsters, or rabbits received an oral dose of 10 mg ammonium [^{14}C]PFOA/kg and ^{14}C in tissues was measured at 120 or 168 hours (rabbits) hours post-dosing. In male rats, the highest concentrations of ^{14}C occurred in blood, liver and kidney, and all tissues combined accounted for approximately 60% of the dose. However, in female rats, concentrations of ^{14}C in all tissues were below limits of quantification. In mice, liver concentrations were similar in males and females, and liver showed the highest concentrations; ^{14}C levels in all tissues combined were lower in females compared to males. The opposite pattern was evident in hamsters and rabbits, with males having lower tissue levels than females, although, in common with rats and mice, blood, liver and kidney had the highest concentrations. Male rats that received a single oral dose of 5 mg PFOSA/kg had liver PFOSA concentrations that were 3–5 times higher than serum concentrations 1 day post-dosing (Seacat and Luebker 2000).

Sex differences in elimination that give rise to sex differences in tissue levels following oral exposure to perfluoroalkyls in rats are not evident in studies conducted with nonhuman primates. Rhesus monkeys that received 3 or 10 mg ammonium PFOA/kg/day for 90 days had liver concentrations of 48 $\mu\text{g/g}$ (one male) or 50 $\mu\text{g/g}$ (one female) at the low dose and 45 $\mu\text{g/g}$ (one male) and 72 $\mu\text{g/g}$ (one female) at the higher dose, with corresponding serum concentrations of 3 and 7 $\mu\text{g/mL}$, and 9 and 10 $\mu\text{g/mL}$, respectively (Griffith and Long 1980). Although limited to only one animal per sex, these results suggest that liver levels did not increase proportionately with increasing dose. A similar observation was made in a study of male *Cynomolgus* monkeys (Butenhoff et al. 2004c). In male monkeys that received daily oral doses of 3 or 10 mg ammonium PFOA kg/day for 27 weeks, liver PFOA concentrations ranged from 11 to 18 $\mu\text{g/g}$ at the low dose and from 6 to 22 $\mu\text{g/g}$ at the higher dose. Mean serum concentrations measured after 6 weeks of exposure (which may have represented steady-state concentrations) were 77,000 ng/mL in the low-dose group and 86,000 ng/mL in the higher dose group. In this same study, an analysis of serum PFOA kinetics following an intravenous dose of PFOA revealed similar elimination kinetics in males and females (Butenhoff et al. 2004c; see Section 3.1.4). In *Cynomolgus* monkeys that received daily oral doses of PFOS (0, 0.03, 0.15, or 0.75 mg PFOS/kg/day) for 26 weeks, liver concentrations of PFOS and serum concentration were similar in males and females (liver:serum ratios ranged from 1 to 2) and increased in approximate proportion to the administered dose (Seacat et al. 2002).

3. TOXICOKINETICS, SUSCEPTIBLE POPULATIONS, BIOMARKERS, CHEMICAL INTERACTIONS

Table 3-1. Tissue Distribution and Excretion of ¹⁴C-Radioactivity from Both Sexes of Rats, Mice, Hamsters, and Rabbits Dosed with ¹⁴C-Labeled APFO^a

Sample	µg Equivalent per g (mL) wet weight ^b							
	Rat		Mouse		Hamster		Rabbit	
	Male	Female	Male	Female	Male	Female	Male	Female
Blood	23.5	<0.1	13.8	10.1	0.1	8.8	<0.1	0.1
Liver	40.0	<0.1	43.2	45.3	0.3	7.3	0.1	1.5
Kidneys	24.0	<0.1	2.9 ^c	2.2 ^c	0.2	7.1	0.1	0.4
Lungs	8.7	<0.1	1.4 ^c	1.3 ^c	<0.1	3.8	<0.1	0.1
Heart	6.4	<0.1	1.2 ^c	0.6 ^c	<0.1	2.9	<0.1	<0.1
Skin	4.8	<0.01	3.5	0.2	<0.1	3.4	<0.1	<0.1
Testes	3.2	–	0.9 ^c	–	<0.1	–	<0.1	–
Muscle	1.9	<0.1	1.1	0.5	<0.1	0.9	<0.1	<0.1
Fat	1.7	<0.1	1.6	1.3	<0.1	1.5	<0.1	<0.1
Brain	0.6	<0.1	0.2 ^c	0.8 ^c	<0.1	0.3	<0.1	<0.1
	Percent of dose							
Tissues	59.6	0.6	73.6	50.0	0.7	26.5	<0.1	0.3
Urine	25.6	73.9	3.4	6.7	90.3	45.3	76.8	87.9
Feces	9.2	27.8	8.3	5.4	8.2	9.3	4.2	4.6
Expiration	3.6	1.5	5.2	4.4	1.3	2.9	No data	No data
Cage wash	0.6	0.8	4.9	4.9	0.6	2.1	0.5	4.8
Percent recovered	98.5	104.6	95.4	71.4	101.1	86.1	81.6	97.6

^aThe rabbits were sacrificed 168 hours after dosing; all other animals were sacrificed 120 hours after dosing.

^bThe µg equivalent calculations were based on the specific activity of ¹⁴C-labeled APFO, which was 1.1x10⁶ DPM/mg. The µg equivalent per g wet weight could not accurately be determined below 0.1 µg/g.

^cRepresents the µg equivalents for the entire organ.

APFO = ammonium perfluorooctanoate

Source: Hundley et al. 2006

Bogdanska et al. (2014) examined distribution of ³⁵S in 20 tissues following dietary exposure of adult male C57/BL6 mice to PFBuS (16 mg/kg/day) for 1–5 days. ³⁵S was detected in all tissues and concentrations reached plateau levels after 3 days of exposure. After 5 days, tissue:blood ratios (excluding stomach and small intestine) were >1 for liver (tissue:blood=1.6), kidney (tissue:blood=1.3), whole bone (tissue:blood=1.1), and cartilage (tissue:blood=1.1). At all-time points, approximately 90% of the ingested ³⁵S was recovered in combined blood, liver, bone, skin, and muscle.

Subcellular Distribution. The subcellular distribution of perfluoroalkyls has been examined in rats (Han et al. 2004, 2005; Kudo et al. 2007; Vanden Heuvel et al. 1992b). Two hours following an oral dose of 25 mg ammonium [¹⁴C]PFOA/kg, sex differences were noted in the subcellular distribution of ¹⁴C in

3. TOXICOKINETICS, SUSCEPTIBLE POPULATIONS, BIOMARKERS, CHEMICAL INTERACTIONS

liver; females had approximately 50% of total ^{14}C in the cytosolic fraction compared to 26% in males (Han et al. 2005). The distributions to other cell fractions were: nuclear/cell debris fraction, 30% females, 40% males; lysosomes, 12% females, 14% males; mitochondria, 8% females, 16% males; and ribosomes, <3% males and females. In kidney, 80 and 70% of the ^{14}C was associated with the cytosolic fraction in males and females, respectively, 16–22% in the nuclear/cell debris fraction, and the remainder in lysosome/mitochondria/ribosome fractions. In liver, approximately 55% of cytosolic ^{14}C was bound to proteins (>6,000 Da) in both males and females, whereas in kidney, 42% of the cytosolic fraction was bound to protein in males and 17% in females. The subcellular distribution of PFOA is dose-dependent. In rats, 2 hours following an intravenous dose of 0.041 mg [^{14}C]PFOA/kg, approximately 5% ^{14}C in the liver was associated with the cytosolic fraction, whereas approximately 45% was in the cytosolic fraction following a dose of 16.6 mg/kg (Kudo et al. 2007). A small component of tissue-associated PFOA and PFDeA appeared to be bound covalently to protein. Following an intraperitoneal dose of 9.4 $\mu\text{mol/kg}$ [^{14}C]PFDeA or [^{14}C]PFOA (4.2 mg/kg), approximately 0.1–0.5% of liver ^{14}C was bound covalently (i.e., was not removed by repeated extraction with a methanol/ether and ethyl acetate; Vanden Heuvel et al. 1992b). Covalent binding was detected when cytosolic or microsomal fractions of rat liver were incubated *in vitro* with [^{14}C]PFDeA (Vanden Heuvel et al. 1992b).

PFOA binds to rat kidney and urine $\alpha_2\text{u}$ -globulin; dissociation constants were estimated to be approximately 1.5 and >2 mM (for a single binding site) for the proteins isolated from rat kidney and urine, respectively. These values suggest relatively low affinity for the protein, compared to other ligands that are known to induce hyaline droplet nephropathy (10^{-4} – 10^{-7} M; Han et al. 2004).

Maternal-fetal Transfer. Perfluoroalkyls can be transferred to the fetus during pregnancy (Cariou et al. 2015; Fei et al. 2007; Fisher et al. 2016; Fromme et al. 2010; Glynn et al. 2012; Gützkow et al. 2012; Hanssen et al. 2010, 2013; Inoue et al. 2004; Kato et al. 2014; Kim et al. 2011, Lee et al. 2013; Lien et al. 2013; Liu et al. 2011; Manzano-Salgado et al. 2015; Midasch et al. 2007; Monroy et al. 2008; Needham et al. 2011; Ode et al. 2013; Porpora et al. 2013; Yang et al. 2016a, 2016b). Studies that measured perfluoroalkyls in maternal and fetal cord blood of matched mother-infant pairs found relatively strong correlations ($r > 0.8$) between maternal and fetal serum (or plasma); however, fetal/maternal serum ratios vary depending on the structure of the perfluoroalkyl (Table 3-2). With some exceptions, longer fluoroalkyl chain length and a terminal sulfonate group are associated with lower fetal/maternal ratios (Glynn et al. 2012; Gützkow et al. 2012; Hanssen et al. 2013; Kim et al. 2011; Liu et al. 2011; Needham et al. 2011). PFOS was detected in amniotic fluid obtained from amniocentesis (Jensen et al. 2012). The

3. TOXICOKINETICS, SUSCEPTIBLE POPULATIONS, BIOMARKERS, CHEMICAL INTERACTIONS

median concentration in amniotic fluid samples from 300 pregnancies (from the Danish amniotic fluid sample back) was 1.1 ng/mL.

Table 3-2. Serum (or Plasma) Concentrations in Matched Human Maternal-Infant Pairs

Study	Perfluoro-alkyl	Perfluoroalkyl chain length	N	Maternal (ng/mL)	Cord (ng/mL)	Ratio ^a	r
Glynn et al. 2012	PFOA	7	413	4	1	NR	0.89
	PFOS	8	413	29	5	NR	0.86
	PFNA	8	413	0.6	0.1	NR	0.53
Cariou et al. 2015	PFHxS	6	59	0.62	0.34	0.56	0.99
	PFOA	7	89	1.05	0.86	0.78	0.83
	PFOS	8	94	3.07	1.11	0.38	0.88
	PFNA	8	22	0.43	0.27	0.51	0.92
Fisher et al. 2016	PFHxS	6	315	NR	NR	0.23	NR
	PFOA	7	865	NR	NR	0.28	NR
	PFOS	8	648	NR	NR	0.14	NR
Fromme et al. 2010	PFHxS	6	53	0.60	0.30	0.50	0.89
	PFOA	7	53	2.60	1.70	0.65	0.94
	PFOS	8	53	3.50	1.10	0.31	0.89
	PFNA	8	53	0.60	<0.4	ND	ND
Gützkow et al. 2012	PFHxS	6	123	0.34	0.23	0.68	0.70
	PFOA	7	123	1.25	1.03	0.82	0.82
	PFOS	8	123	5.37	1.78	0.33	0.74
	PFNA	8	123	0.40	0.16	0.40	0.64
	PFDeA	9	123	0.10	0.04	ND	ND
	PFUA	10	123	0.19	0.06	0.32	0.67
Hanssen et al. 2013	PFHxS	6	7	0.26	0.17	0.65	ND
	PFOA	7	7	1.50	1.26	0.84	ND
	PFOS	8	7	10.70	3.93	0.37	ND
	PFNA	8	7	0.89	0.50	0.56	ND
	PFOSA	8	7	0.41	0.45	1.10	ND
	PFUA	10	7	0.33	0.16	0.48	ND
Inoue et al. 2004	PFOA	7	15	8.90	2.90	0.32	0.94
Kim et al. 2011	PFHxS	6	20	0.89	0.58	0.65	ND
	PFOA	7	20	1.60	1.10	0.69	ND
	PFOS	8	20	5.60	2.00	0.36	ND
	PFNA	8	20	0.79	0.37	0.47	ND
	PFDeA	9	20	0.36	0.01	0.03	ND
	PFUA	10	20	1.60	0.46	0.29	ND

3. TOXICOKINETICS, SUSCEPTIBLE POPULATIONS, BIOMARKERS, CHEMICAL INTERACTIONS

Table 3-2. Serum (or Plasma) Concentrations in Matched Human Maternal-Infant Pairs

Study	Perfluoro-alkyl	Perfluoroalkyl chain length	N	Maternal (ng/mL)	Cord (ng/mL)	Ratio ^a	r
Kato et al. 2014	PFHxS	6	78	1.20	0.60	0.50	0.89
	PFOA	7	78	3.30	3.10	0.89	0.88
	PFOS	8	78	8.50	3.50	0.31	0.82
	Me-PFOSA-AcOH	8	78	0.20	0.30	1.50	0.92
	PFNA	8	78	0.66	0.41	0.62	0.79
	PFDeA	9	78	0.20	ND	ND	ND
Lee et al. 2013	PFHS	6	70	1.35	0.67	0.57	ND
	PFOA	7	70	2.73	2.09	0.84	ND
	PFOS	8	70	10.77	3.44	0.35	ND
Liu et al. 2011	PFHxS	6	50	0.08	0.06	0.79	0.59
	PFOA	7	50	1.66	1.50	0.91	0.91
	PFOS	8	50	3.18	1.69	0.53	0.75
	PFNA	8	50	0.55	0.33	0.61	0.82
	PFDeA	9	50	0.58	0.24	0.41	0.82
	PFUA	10	50	0.56	0.30	0.53	0.70
	PFDoA	11	50	0.08	ND	ND	ND
Manzano-Salgado et al. 2015	PFHxS	6	66	0.84	0.40	0.446	NR
	PFOA	7	66	2.97	1.90	0.746	NR
	PFOS	8	66	6.99	1.86	0.299	NR
	PFNA	8	66	0.85	0.32	0.4	NR
Midasch et al. 2007	PFOA	7	11	2.70	3.40	1.30	0.42
	PFOS	8	11	12.10	7.20	0.60	0.72
Monroy et al. 2008	PFHxS	6	101	4.05	5.05	1.25	ND
	PFOA	7	101	2.24	1.94	0.87	0.94
	PFOS	8	101	16.19	7.19	0.44	0.91
	PFNA	8	101	0.80	0.94	1.18	ND
Needham et al. 2011	PFHxS	6	12	12.30	9.10	0.74	0.05
	PFOA	7	12	4.20	3.10	0.72	0.91
	PFOS	8	12	19.70	6.60	0.34	0.82
	PFNA	8	12	0.76	0.37	0.50	0.84
	PFDeA	9	12	0.34	0.10	0.29	0.91
Ode et al. 2013	PFOA	7	263	2.30	2.80	1.30	0.74
	PFOS	8	263	17.00	7.40	0.45	0.76
	PFNA	8	263	0.31	0.26	0.93	0.51
Porpora et al. 2013	PFOA	7	38	2.90	1.60	0.55	0.70
	PFOS	8	38	3.20	1.40	0.44	0.72

3. TOXICOKINETICS, SUSCEPTIBLE POPULATIONS, BIOMARKERS, CHEMICAL INTERACTIONS

Table 3-2. Serum (or Plasma) Concentrations in Matched Human Maternal-Infant Pairs

Study	Perfluoro-alkyl	Perfluoroalkyl chain length	N	Maternal (ng/mL)	Cord (ng/mL)	Ratio ^a	r
Yang et al. 2016a	PFHxS	6	50	0.064	0.033	0.52	0.80
	PFOA	7	50	1.24	1.03	0.83	0.93
	PFOS	8	50	2.98	1.23	0.41	0.88
	PFNA	8	50	0.55	0.35	0.64	0.89
	PFDeA	9	50	0.56	0.22	0.39	0.92
	PFUA	10	50	0.55	0.23	0.42	0.88
	PFDoA	11	50	0.085	0.058	0.68	0.76
Yang et al. 2016b	PFHxS	6	157	0.53	0.26	0.43	0.68
	PFOA	7	157	1.74	1.32	0.71	0.81
	PFOS	8	157	4.23	1.52	0.36	0.63
	PFNA	8	157	0.46	0.23	0.49	0.70
	PFDeA	9	157	0.37	0.13	0.35	0.65
	PFUA	10	157	0.38	0.14	0.36	0.63
	PFDoA	11	157	0.040	0.026	0.61	0.52

^aRatio of cord:maternal perfluoroalkyl level

ND = no data (detected but below limit of quantification); NR = not reported; PFDeA = perfluorodecanoic acid; PFDoA = perfluorododecanoic acid; PFHxS = perfluorohexane sulfonic acid; PFNA = perfluorononanoic acid; PFOA = perfluorooctanoic acid; PFOS = perfluorooctane sulfonic acid; PFOSA = perfluorooctane sulfonamide; PFTTrDA = perfluorotridecanoic acid; PFUA = perfluoroundecanoic acid;

Studies in rats and mice provide further support for maternal-fetal transfer of perfluoroalkyls. Following gavage administration of 0.1–10 mg/kg/day PFOS to rats during gestation, PFOS was distributed to fetal serum, liver, and brain, with fetal concentrations increasing with maternal dose (Chang et al. 2009; Lau et al. 2003; Luebker et al. 2005a, 2005b; Thibodeaux et al. 2003). Levels in fetal serum and liver generally were similar and higher than in brain. Studies did not report on concentrations of PFOS in other fetal tissues. Paired fetal-maternal levels of PFOS were examined in rats following exposure (gavage) to potassium PFOS at doses of 0.1, 0.4, 1.6, or 3.2 mg/kg/day on GDs 0–20 (Luebker et al. 2005b). On GD 21, fetal:maternal serum ratios were 2.1, 1.7, 1.6, and 1.1 at doses of 0.1, 0.4, 1.6, and 3.2 mg/kg/day, respectively; these results suggest that fetal:maternal serum ratios varied inversely with dose. Fetal:maternal liver ratios (0.37–0.44) were similar across the dose range. In mice administered a single gavage dose of 12.5 mg/kg [³⁵S]PFOS on GD 16, fetal organ:maternal blood ratios of ³⁵S on GD 18 were 2.8 for kidneys, 2.6 for liver, 2.3 for blood, 2.1 for lungs, and 1.2 for brain (Borg et al. 2010).

3. TOXICOKINETICS, SUSCEPTIBLE POPULATIONS, BIOMARKERS, CHEMICAL INTERACTIONS

Maternal-fetal transfer of PFOA has also been studied in rats and mice (Das et al. 2008; Hinderliter et al. 2005). In rats, PFOA concentrations in amniotic fluid, placenta, and fetus (measured on days 10, 15, or 21 of gestation) increased with increasing maternal oral dose (3, 10, or 10 mg/kg/day, administered daily beginning on GD 4) (Hinderliter et al. 2005). Fetal plasma concentrations of PFOA measured on GD 21 were approximately 40% of maternal plasma concentration. Following gavage administration of 0.01, 1, or 5 mg/kg ammonium PFOA on GD 17 in mice, PFOA was detected in amniotic fluid and pup serum, with dose-dependent increases (Fenton et al. 2009). On PND 1, pup serum PFOA concentrations were approximately 1.7–2.0-fold greater than levels in maternal serum.

Following administration of ammonium PFBA (35, 175, or 350 mg/kg) to pregnant mice on GDs 0–17, fetal serum and liver levels of PFBA were determined on PND 1 (Das et al. 2008). The fetal:maternal serum ratio of PFBA was approximately 0.15 and did not vary with maternal dose. Fetal liver:serum ratios were 0.44, 0.75, and 0.78 at maternal doses of 35, 175, and 350 mg/kg, respectively. PFHxS was detected in fetal blood and in the liver of neonates following exposure of dams to potassium PFHxS (0.3, 1, 3, and 10 mg/kg) throughout gestation (Butenhoff et al. 2009a); concentrations in serum and liver increased with dose.

Maternal-infant Transfer. Perfluoroalkyls can be transferred to nursing infants (Barbarossa et al. 2013; Cariou et al. 2015; Fromme et al. 2010; Kärman et al. 2007; Kim et al. 2011; Kuklennyik et al. 2004; Liu et al. 2011; Tao et al. 2008a, 2008b). Studies that measured perfluoroalkyls in maternal serum (or plasma) and breast milk in matched mother-infant pairs found highly variable correlations (Table 3-3). Relatively high correlations have been reported for PFOA (Kärman et al. 2007; Liu et al. 2011). Transfer to breast milk appears to be a significant route of elimination of perfluoroalkyls during breastfeeding. Comparisons of serum concentrations of women who did or did not breastfeed their infants showed that breastfeeding significantly decreases maternal serum concentrations of PFOA, PFOS, PFHxS, and PFNA (Bjermo et al. 2013; Brantsaeter et al. 2013; Mondal et al. 2012, 2014; von Ehrenstein et al. 2009). The decrease was estimated to be 2–3% decrease per month of breastfeeding (Brantsaeter et al. 2013; Mondal et al. 2012, 2014). Concentrations of perfluoroalkyls in breast milk also decrease with breastfeeding duration (Tao et al. 2008b; Thomsen et al. 2010). Numerous perfluoroalkyl compounds (including PFOS, PFOA, PFBuS, PFHxS, PFNA, PFDeA, PFDoA, PFUA, and PFOSA) have been detected in breast milk samples in women in China, Korea, Japan, Malaysia, Cambodia, India, Korea, Vietnam, Indonesia, Norway, Philippines, Sweden, and the United States (Forns et al. 2015; Fujii et al. 2012; Kang et al. 2016; Kärman et al. 2007; Kim et al. 2011; Liu et al. 2010, 2011; Mondal et al. 2014; So et al. 2006b; Tao et al. 2008a). The mean concentrations for perfluoroalkyls in breast milk collected

3. TOXICOKINETICS, SUSCEPTIBLE POPULATIONS, BIOMARKERS, CHEMICAL INTERACTIONS

from 45 women in Massachusetts were 0.131 ng/mL (range of <0.032.0–617 ng/mL) for PFOS, 0.043.8 ng/mL (<0.0301–0.161 ng/mL) for PFOA, and 0.0145 ng/mL (<0.0120–0.0638 ng/mL) for PFHxS (Tao et al. 2008b). PFHpA, PFDeA, PFUA, PFDoA, and PFBUxS were also detected in the breast milk; however, ≤4 samples had levels that exceeded the limit of quantitation. Serum concentrations in breastfed infants can be higher than maternal levels (Fromme et al. 2010; Mondal et al. 2014; Post et al. 2012). Mogensen et al. (2015b) reported that following weaning, significant (<0.0001) decreases were observed in infant serum concentrations of PFOS, PFOA, and PFHxS.

Table 3-3. Matched Serum (or Plasma) and Breast Milk Concentrations in Humans

Study	Perfluoroalkyl	Perfluoroalkyl chain length	N	Serum (ng/mL)	Milk (ng/mL)	Ratio ^a	r
Cariou et al. 2015	PFHxS	6	9	2.28	0.026	0.011	0.36
	PFOA	7	10	1.22	0.041	0.034	0.72
	PFOS	8	19	3.62	0.040	0.011	0.85
Kärman et al. 2007a	PFHxS	6	12	4.7	0.085	0.020	ND
	PFOA	7	12	3.8	0.49	0.120	0.88
	PFOS	8	12	20.7	0.20	0.010	0.83
	PFOSA	8	12	0.24	0.013	0.070	ND
	PFNA	8	12	0.80	0.017	0.010	ND
Kim et al. 2011	PFHxS	6	20	0.89	0.007	0.008	NS
	PFOA	7	20	1.60	0.041	0.026	NS
	PFOS	8	20	5.60	0.061	0.011	0.60
	PFNA	8	20	0.79	<0.0088	ND	ND
	PFDeA	9	20	0.36	<0.018	ND	ND
	PFUA	10	20	1.60	<0.024	ND	ND
Liu et al. 2011	PFHxS	6	50	0.08	ND	ND	ND
	PFOA	7	50	1.66	0.181	0.109	0.77
	PFOS	8	50	3.18	0.056	0.018	0.57
	PFNA	8	50	0.55	0.026	0.048	0.62
	PFDeA	9	50	0.58	0.02	0.034	0.54
	PFUA	10	50	0.56	0.026	0.046	0.44
	PFDoA	11	50	0.08	ND	ND	ND
	PFTTrDA	12	50	0.08	ND	ND	ND

^aMilk to serum ratio

ND = no data (detected but below limit of quantification); NS = not significantly correlated;

PFDeA = perfluorodecanoic acid; PFDoA = perfluorododecanoic acid; PFHxS = perfluorohexane sulfonic acid;

PFNA = perfluorononanoic acid; PFOA = perfluorooctanoic acid; PFOS = perfluorooctane sulfonic acid;

PFOSA = perfluorooctane sulfonamide; PFTTrDA = perfluorotridecanoic acid; PFUA = perfluoroundecanoic acid;

3. TOXICOKINETICS, SUSCEPTIBLE POPULATIONS, BIOMARKERS, CHEMICAL INTERACTIONS

Studies conducted in rats and mice provide further support for maternal-infant transfer of perfluoroalkyls through breast milk (Fenton et al. 2009; Hinderliter et al. 2005; Lau et al. 2003; Luebker et al. 2005a; Yu et al. 2009b). PFOA concentrations in breast milk of nursing rats increased with increasing maternal oral dose (3, 10, or 10 mg/kg/day, administered daily beginning on GD 4). Milk concentrations of PFOA measured on postpartum days 3, 7, 14, or 21 in rats were approximately 0.1 of maternal plasma concentration. In dams exposed to 0.1, 1, or 5 mg/kg PFOA by gavage on GD 17, a dose-dependent increase in PFOA concentrations in breast milk was observed on PND 2, with breast milk:serum ratios of approximately 0.15, 0.38, and 0.25 at 0.1, 1, and 5 mg/kg doses, respectively; milk/serum concentration ratios for PFOA ranged from 0.15 to 0.56 (Fenton et al. 2009). Following lactational exposure of control rat pups to PFOS in breast milk of dams treated with dietary PFOS (3.2 mg/kg diet; approximately equivalent to 0.33 mg/kg/day), pup serum and liver concentrations increased throughout the 35-day lactation period (Yu et al. 2009b). At PND 35, the pup liver:serum PFOS ratios were 2.55 and 2.43 in male and female pups, respectively. Results of a cross-foster study show that pups are exposed to PFOS through breast milk (Luebker et al. 2005a). Postnatal toxicity observed in cross-fostered pups that nursed from exposed dams provides additional evidence of maternal-infant transfer of PFOS in rats and mice (see Section 2.17).

Mechanisms of Distribution. Perfluoroalkyls in plasma bind to serum albumin and various other plasma proteins including gamma-globulin, alpha-globulin, alpha-2-macroglobulin, transferrin, and beta-lipoproteins (Bischel et al. 2011; Butenhoff et al. 2012c; Chen and Guo 2009; Han et al. 2003, 2005; Kerstner-Wood et al. 2003; Luo et al. 2012; Ohmori et al. 2003; Salvalaglio et al. 2010; Vanden Heuvel et al. 1992b; Wu et al. 2009; Ylinen and Auriola 1990; Zhang et al. 2009). The dissociation constant for albumin-bound PFOA in serum is approximately 0.4 mM (0.38 mM, ± 0.04 SD for human serum albumin; 0.36 nM, ± 0.08 SD for rat serum albumin) and involves 6–9 binding sites (Han et al. 2003). Noncovalent binding appears to be at the same sites as fatty acids (Chen and Guo 2009). Interactions between PFOS and human serum albumin include interaction of PFOS polar sulfonyl groups with albumin hydrophilic sites and interaction of perfluorinated groups with albumin hydrophobic sites (Luo et al. 2012).

Absorbed perfluoroalkyls distribute from plasma to soft tissues, with the highest extravascular concentrations achieved in liver. Mechanisms by which perfluoroalkyls enter the liver have not been elucidated and may involve interactions with organic anion transporters that function in the distribution of fatty acids or other organic anions (Andersen et al. 2008). PFOA appears to be a substrate for organic anion transporters in the luminal and basolateral membranes of renal tubular epithelial cells, which

3. TOXICOKINETICS, SUSCEPTIBLE POPULATIONS, BIOMARKERS, CHEMICAL INTERACTIONS

facilitates entry of PFOA into renal tubular cells (Kudo et al. 2002; Nakagawa et al. 2008; Vanden Heuvel et al. 1992b; Weaver et al. 2010). The subcellular distribution of PFOA is sex- and dose-dependent in rats (Han et al. 2005; Kudo et al. 2007) and the association with the membrane fraction of liver cells decreases with increasing dose (Kudo et al. 2007), consistent with limited capacity of membrane proteins that bind PFOA (e.g., membrane transport proteins). Intracellular PFOA binds to proteins; protein complexes formed have not been fully characterized. PFOA exhibits a low affinity for binding to rat kidney and urine alpha-2 μ -globulin (dissociation constants 1.5 and >2 mM, respectively) (Han et al. 2004).

3.1.3 Metabolism

Results of available intraperitoneal and *in vitro* studies suggest that the perfluoroalkyls discussed in this profile are not metabolized and do not undergo chemical reactions in the body. Studies conducted in male and female rats did not detect fluorine metabolites in the urine, plasma, or liver following a single injection of 4–150 mg/kg PFOA or 5–50 mg/kg PFDeA (Goecke et al. 1992; Vanden Heuvel et al. 1991b, 1991c; Ylinen and Auriola 1990). Following a single intraperitoneal dose of approximately 4 mg/kg of ¹⁴C-PFOA, only parent compound was excreted in the urine and bile (Vanden Heuvel et al. 1991c). PFOA was not metabolized when incubated with microsomal fractions of human or rat intestine, kidney, or liver homogenates (Kemper and Nabb 2005). Although no studies examining metabolism of perfluoroalkyls following inhalation, oral, or dermal exposure were identified, metabolism by these exposure routes is not anticipated.

3.1.4 Excretion

As noted in Section 3.1.3 (Metabolism), there is presently no evidence that perfluoroalkyls undergo metabolism. Therefore, route-specific differences in excretion patterns are not expected. Selected studies in which elimination half-lives rates (i.e., $t_{1/2}$) of perfluoroalkyls have been determined (see summaries in Table 3-5) show that, in general, elimination $t_{1/2}$ values are similar following intravenous, intraperitoneal, and oral exposures. Findings suggest that the route of absorption has no substantial effect of rates of elimination of absorbed perfluoroalkyls (Butenhoff et al. 2004c; Chang et al. 2008a; Kemper 2003; Kudo et al. 2002; Ohmori et al. 2003; Vanden Heuvel et al. 1991b; Ylinen et al. 1990). As discussed in this section, perfluoroalkyls are primarily eliminated in the urine, with smaller amounts eliminated in the feces and breast milk (see Section 3.1.2; Distribution, Maternal-fetal Transfer). Perfluoroalkyls undergo biliary excretion, but substantial reabsorption occurs; therefore, biliary excretion does not represent a major elimination pathway. Perfluoroalkyls do not appear to be eliminated in sweat, as induction of perspiration

3. TOXICOKINETICS, SUSCEPTIBLE POPULATIONS, BIOMARKERS, CHEMICAL INTERACTIONS

by exercise or sauna does not alter clearance of PFOA, PFOA, PFHxA, or PFNA (Genuis et al. 2013). Perfluoroalkyls are eliminated in menstrual fluid, which appears to contribute to sex differences in serum elimination rates (Wong et al. 2014, 2015; Zhang et al. 2013).

In humans, absorbed perfluoroalkyls are excreted in urine. Estimates of renal clearance of PFOA and PFOS from serum in humans ranged from 0.8 to 3.3 mL/day for PFOA (serum concentration range: 5–16 ng/mL) and 0.1–1.5 mL/day for PFOS (serum concentration range 9–49 ng/mL). These clearance values were <0.001% of glomerular filtration rate (Harada et al. 2005a). Assuming that 99% of the serum PFOA and PFOS was bound to albumin (see Section 3.1.2), <0.1% of filtered perfluoroalkyls were excreted in urine, suggesting extensive reabsorption of filtered PFOA and PFOS in the renal tubule. Renal clearance was not different in males and females. Mean renal clearances for PFOA were 2.12 mL/day (± 0.80 SD, n=5) in males and 1.15 (± 0.33 SD, n=5) in five females (mean age 22 and 23 years, respectively). Mean renal clearances for PFOS were 0.66 mL/day (± 0.48 SD, n=5) in males and 0.91 (± 0.56 SD, n=5) for females. Fujii et al. (2015a) reported renal clearances (mL/day/kg; mean \pm SD) for several perfluoroalkyls in humans (three males and five females), including PFOA (0.044 \pm 0.01), PFNA (0.038 \pm 0.01), PFDeA (0.015 \pm 0.01), PFUA (0.005 \pm 0.00), and PFDoA (0.005 \pm 0.00). Zhang et al. (2013) reported renal clearances for several perfluoroalkyls (mL/day/kg) and found that clearance of PFOS was similar in younger females (≤ 50 years, 0.050 mL/day/kg, 95% CI 0.037–0.064) and a combined group of males and older females (grouped together since there were no significant differences in serum concentrations) (0.037 mL/day/kg, 95% CI 0.026–0.049). However, there appeared to be differences in renal clearance for PFOA; clearance rates were 0.30 mL/day/kg (95% CI 0.11–0.49) in young females and 0.77 mL/day/kg (95% CI 0.47–1.1) in the combined older women and all males group. Urinary excretion of perfluoroalkyls may show sex and age differences (Zhang et al. 2015b). Urinary excretion of PFOA as a fraction of estimated intake in male adults (n=29) was 31% (p=0.002) higher than in nonpregnant female adults (n=25). In addition, urinary excretion of PFOS was inversely correlated with age (r=0.334; p=0.015).

Absorbed PFOA and PFOS are also secreted into bile in humans, but the biliary pathway is not a major excretory pathway because PFOA and PFOS are reabsorbed after biliary secretion. Estimates of total body clearance, serum-to-urine clearance, and serum-to-bile clearance of PFOA and PFOS in humans are presented in Table 3-4 (Harada et al. 2007). Biliary clearances of PFOA and PFOS were 1.06 and 2.98 mL/kg body weight/day, respectively, and greatly exceeded total body clearance (0.150 and 0.106 mL/kg/day) and urinary clearance (0.030 and 0.015 mL/kg/day). Based on these estimates, approximately 89% of the PFOA secreted into bile and 97% of secreted PFOS was estimated to have been

3. TOXICOKINETICS, SUSCEPTIBLE POPULATIONS, BIOMARKERS, CHEMICAL INTERACTIONS

reabsorbed from the gastrointestinal tract. Fujii et al. (2015a) also reported that biliary clearances of several perfluoroalkyls (PFOA, PFNA, PFDeA, PFUA, PFDoA) were much higher than total body clearance in humans, further supporting that perfluoroalkyls excreted in bile undergo extensive reabsorption.

Table 3-4. Excretory Clearance of PFOA and PFOS in Humans

Parameter	Units	PFOA	PFOS
Serum $t_{1/2}$ ^a	day	1,387	1,971
Total clearance ^b	mL/kg/day	0.150	0.106
Urinary clearance ^c	mL/kg/day	0.030	0.150
Biliary clearance ^d	mL/kg/day	1.06	2.98
Reabsorbed from bile ^e	%	89	97

^aEstimates from Olsen et al. (2005).

^b $\ln(t_{1/2}) \times V_d$, where V_d is the volume of distribution (300 mL/kg).

^cEstimates from Harada et al. (2005a).

^dEstimates from Harada et al. (2007).

^e $1 - (\text{Total-Urinary})/\text{Biliary}$.

PFOA = perfluorooctanoic acid; PFOS = perfluorooctane sulfonic acid

Source: Harada et al. (2007)

Studies conducted in nonhuman primates and rodents provide further evidence that urine is the major route of excretion of perfluoroalkyls, accounting for >93% of absorbed PFOA and PFOS (Benskin et al. 2009; Butenhoff et al. 2004c; Chang et al. 2008a, 2012; Chengelis et al. 2009; Hanhijarvi et al. 1982, 1987; Hundley et al. 2006; Johnson and Ober 1979, 1980, 1999a, 1999b; Kemper 2003; Kudo et al. 2001; Olsen et al. 2009; Sundström et al. 2012; Vanden Heuvel et al. 1991b, 1991c). Studies conducted in rats have shown that PFDeA, PFNA, PFOA, and PFHxA are secreted in bile and undergo extensive reabsorption from the gastrointestinal tract (Kudo et al. 2001; Vanden Heuvel et al. 1991b, 1991c). PFOS, PFHxS, and PFBuS are excreted in feces following intravenous dosing of rats, suggesting that these perfluoroalkyls may also be secreted into bile (Chang et al. 2012; Johnson et al. 1984; Olsen et al. 2009; Sundström et al. 2012). The percentage of the dose excreted in the feces appears to vary with compound, 8–13% for PFOS, <0.5% for PFHxS, and 0.13–0.36% for PFBuS. Renal clearances of PFOA from plasma in rats were approximately 0.032 mL/minute/kg body weight in male rats and 0.73 mL/minute/kg in female rats; plasma concentrations of PFOA during these measurements ranged from approximately 0.8 to 80 µg/mL (Kudo et al. 2002). In the latter study, approximately >95% of plasma PFOA was bound to high molecular weight protein and the glomerular filtration rate was approximately 10 mL/minute/kg; therefore, urinary excretion of PFOA was approximately 6% of the rate

3. TOXICOKINETICS, SUSCEPTIBLE POPULATIONS, BIOMARKERS, CHEMICAL INTERACTIONS

of glomerular filtration of PFOA in males and 146% in females. These estimates indicate that net renal tubular reabsorption of filtered PFOA occurred in male rats, whereas net renal tubular secretion of PFOA occurred in female rats (i.e., clearance of free PFOA in plasma > glomerular filtration rate). The pronounced sex difference in renal clearance of PFOA has been attributed to modulation of renal excretory transport of PFOA by testosterone and estradiol (Kudo et al. 2002; Vanden Heuvel et al. 1992a; see Section 3.1.5).

Rates of elimination of perfluoroalkyls vary substantially across chemical species and animal species, and show sex differences and age-dependencies within certain species. Table 3-5 summarizes estimates of the elimination $t_{1/2}$ for perfluoroalkyls in humans and experimental animals. In compiling the estimates presented in Table 3-5, preference was given to the terminal $t_{1/2}$ when multiple $t_{1/2}$ values were reported. The significance of the terminal $t_{1/2}$ is that it determines the time required for complete elimination of the perfluoroalkyl as well as the exposure duration required to achieve a steady state. Most of the $t_{1/2}$ values in Table 3-5 were estimated from analyses of data on declining serum concentrations of perfluoroalkyls after a single dose or following cessation of a period of repeated dosing. Estimates of the terminal $t_{1/2}$ based on serum concentrations can vary with the length of the observation period following the last dose and with the modeling approach used to estimate the $t_{1/2}$. Longer observation times are required to estimate the slowest phases of elimination. As a result, estimates of $t_{1/2}$ based on observation periods of 1–2 days can be much shorter than estimates for the same perfluoroalkyl based on observation periods of several weeks. Direct comparisons of $t_{1/2}$ values should be made with consideration of whether or not the observation periods were comparable. Differences in estimation methodology can also contribute to differences in $t_{1/2}$ values. Values reported in Table 3-5 are based on fitting data to single or multi-compartment models, or noncompartmental modeling of the data. While the terminal $t_{1/2}$ provides a metric for comparing times required for complete elimination and steady state, it does not always provide a measure of how rapidly the perfluoroalkyl is cleared from the body. A more useful metric for this is the systemic clearance (Cl_s), typically estimated from the absorbed dose (AD) and the area under the serum concentration curve (AUC_s):

$$Cl_s = \frac{AD}{AUC_s} \quad \text{Eq. (3-3)}$$

Equation 3-3 will provide an accurate estimate of systemic clearance following an oral dose if the oral dose is completely absorbed. Accurate estimation of AUC_s also depends on fitness of the underlying

3. TOXICOKINETICS, SUSCEPTIBLE POPULATIONS, BIOMARKERS, CHEMICAL INTERACTIONS

model used to predict serum concentrations. Estimates of systemic clearance based on pharmacokinetics analyses of serum data from animal studies are presented in Table 3-6.

Table 3-5. Summary Elimination Half-Lives for Perfluoroalkyls Estimated in Humans and Experimental Animals

Species, age, and sex	Route	Dose	Exposure duration ^a	Elimination half-life ^b	Reference
PFOA—Human					
Human (n=26), adult, M (24) F (2)	NA	NA	NA	3.8 years (95% CI 3.1–4.4, GM 3.5)	Olsen et al. 2007a
Human (n=20) 15–50 years M	NA	NA	NA	2.8 years (95 %CI 2.4–3.4)	Li et al. 2018
Human (n=30) 15–50 years F	NA	NA	NA	2.4 years (95% CI 2.0–3.0)	Li et al. 2018
Human (n=66), >50 years, M, F	NA	NA	NA	2.6 years (SE 0.4, GM 1.2)	Zhang et al. 2013
Human (n=20), ≤50 years, F	NA	NA	NA	2.1 years (SE 0.3, GM 1.5)	Zhang et al. 2013
Human (n=45) M, F	NA	NA	NA	3.9 years	Worley et al. 2017a
Human (n=5), 22±0.9, M	NA	NA	NA	2.3 years	Harada et al. 2005a
Human (n=5), 68±5, M	NA	NA	NA	2.6 years	Harada et al. 2005a
Human (n=5), 23±3, F	NA	NA	NA	3.5 years	Harada et al. 2005a
Human (n=5), 69±5, F	NA	NA	NA	2.9 years	Harada et al. 2005a
Human (n=200) 54±15, M, F	Oral	NA	NA	2.3 years (95% CI 2.1–2.4)	Bartell et al. 2010
Human (n=643) Adults, M, F	Oral	NA	NA	2.9 years (<4 years) (95% CI 2.3–3.8) 10.1 years (>4 years)	Seals et al. 2011
Human (n=1,029) Adults, M, F	Oral	NA	NA	8.5 years (<9 years) (95% CI 7.1–10.1)	Seals et al. 2011
Humans (n=17) Adults, M, F	Oral	NA	NA	5.1 years (SD 1.7, GM 4.8)	Costa et al. 2009
PFOS—Human					
Human (n=26), adult, M (24) F (2)	NA	NA	NA	5.4 years (95% CI 3.9–6.9, GM 4.8)	Olsen et al. 2007a
Human (n≅1,000), >12–>80 years, M	NA	NA	NA	4.7 years	Wong et al. 2014
Human (n≅1,000), >12–>80 years, F	NA	NA	NA	4.3 years (95% CI 4.1–4.5)	Wong et al. 2015

3. TOXICOKINETICS, SUSCEPTIBLE POPULATIONS, BIOMARKERS, CHEMICAL INTERACTIONS

Table 3-5. Summary Elimination Half-Lives for Perfluoroalkyls Estimated in Humans and Experimental Animals

Species, age, and sex	Route	Dose	Exposure duration ^a	Elimination half-life ^b	Reference
Human (n=66), >50 years, M, F	NA	NA	NA	27 years (SE 3.1, GM 18)	Zhang et al. 2013
Human (n=20), ≤50 years, F	NA	NA	NA	6.2 years (SE 0.5, GM 5.8)	Zhang et al. 2013
Human (n=45) M, F	NA	NA	NA	3.3 years	Worley et al. 2017a
Human (n=20) 15–50 years M	NA	NA	NA	4.6 years (95% CI 3.7–6.1)	Li et al. 2018
Human (n=30) 15–50 years F	NA	NA	NA	3.1 years (95% CI 2.7–3.7)	Li et al. 2018
Human (n=5), 22±0.9, M	NA	NA	NA	4.9 years	Harada et al. 2005a
Human (n=5), 68±5, M	NA	NA	NA	7.4 years	Harada et al. 2005a
Human (n=5), 23±3, F	NA	NA	NA	4.5 years	Harada et al. 2005a
Human (n=5), 69±5, F	NA	NA	NA	4.6 years	Harada et al. 2005a
PFHxS—Human					
Human (n=26), adult, M (24), F (2)	NA	NA	NA	8.5 years (95% CI 6.4–10.6, GM 7.3)	Olsen et al. 2007a
Human (n=20), ≤50 years, F	NA	NA	NA	7.7 years (SE 0.6, GM 7.1)	Zhang et al. 2013
Human (n=20) 15–50 years M	NA	NA	NA	7.4 years (95% CI 6.0–9.7)	Li et al. 2018
Human (n=30) 15–50 years F	NA	NA	NA	4.7 years (95% CI 3.9–5.9)	Li et al. 2018
Human (n=45) M, F	NA	NA	NA	15.5 years	Worley et al. 2017a
Human (n=66), >50 years, M, F	NA	NA	NA	35 years (SE 3.9, GM 25)	Zhang et al. 2013
PFBA—Human					
Human (n=3), adult, M	NA	NA	NA	81 hours (SD 41)	Chang et al. 2008b
Human (n=9), adult, M (7), F (2)	NA	NA	NA	72 hours (SD 38)	Chang et al. 2008b
PFBuS—Human					
Human (n=6), adult M (5), F(1)				665 hours (SD 266)	Olsen et al. 2009
PFNA—Human					
Human (n=66), >50 years, M, F	NA	NA	NA	4.3 years (SE 0.5, GM 3.2)	Zhang et al. 2013
Human (n=20), ≤50 years, F	NA	NA	NA	2.5 years (SE 0.6, GM 1.7)	Zhang et al. 2013

3. TOXICOKINETICS, SUSCEPTIBLE POPULATIONS, BIOMARKERS, CHEMICAL INTERACTIONS

Table 3-5. Summary Elimination Half-Lives for Perfluoroalkyls Estimated in Humans and Experimental Animals

Species, age, and sex	Route	Dose	Exposure duration ^a	Elimination half-life ^b	Reference
PFDeA—Human					
Human (n=66), >50 years, M, F	NA	NA	NA	12 years (SE 1.5, GM 7.1)	Zhang et al. 2013
Human (n=20), ≤50 years, F	NA	NA	NA	4.5 years (SE 0.4, GM 4.0)	Zhang et al. 2013
PFUA—Human					
Human (n=66), >50 years, M, F	NA	NA	NA	12 years (SE 2.0, GM 7.4)	Zhang et al. 2013
Human (n=20), ≤50 years, F	NA	NA	NA	4.5 years (SE 0.5, GM 4.0)	Zhang et al. 2013
PFHpA—Human					
Human (n=66), >50 years, M, F	NA	NA	NA	1.2 years (SE 0.2, GM 0.82)	Zhang et al. 2013
Human (n=20), ≤50 years, F	NA	NA	NA	1.5 years (SE 0.3, GM 1.0)	Zhang et al. 2013
PFOA—Nonhuman primate					
Cynomolgus monkey, adult, M	Oral	10 mg/kg/day	6 months	20.1 days	Butenhoff et al. 2004c
Cynomolgus monkey, adult, M	IV	10 mg/kg	1 day	20.9 days (SD 12.5)	Butenhoff et al. 2004c
Cynomolgus monkey, adult, F	IV	10 mg/kg	1 day	32.6 days (SD 8.0)	Butenhoff et al. 2004c
PFOS—Nonhuman primate					
Cynomolgus monkey, adult, M	Oral	0.15 mg/kg/day	6 months	170 days	Seacat et al. 2002
Cynomolgus monkey, adult, M	Oral	0.75 mg/kg/day	6 months	170 days	Seacat et al. 2002
Cynomolgus monkey, adult, F	Oral	0.15 mg/kg/day	6 months	170 days	Seacat et al. 2002
Cynomolgus monkey, adult, F	Oral	0.75 mg/kg/day	6 months	170 days	Seacat et al. 2002
Cynomolgus monkey, adult, M	IV	2 mg/kg	1 day	132 days (SE 7)	Chang et al. 2012
Cynomolgus monkey, adult, F	IV	2 mg/kg	1 day	110 days (SE 15)	Chang et al. 2012
PFHxA—Nonhuman primate					
Cynomolgus monkey, adult, M	IV	10 mg/kg	1 day	5.3 days (SD 2.5)	Chengelis et al. 2009
Cynomolgus monkey, adult, F	IV	10 mg/kg	1 day	2.4 days (SD 1.7)	Chengelis et al. 2009

3. TOXICOKINETICS, SUSCEPTIBLE POPULATIONS, BIOMARKERS, CHEMICAL INTERACTIONS

Table 3-5. Summary Elimination Half-Lives for Perfluoroalkyls Estimated in Humans and Experimental Animals

Species, age, and sex	Route	Dose	Exposure duration ^a	Elimination half-life ^b	Reference
PFHxS—Nonhuman primate					
Cynomolgus monkey, adult, M	IV	10 mg/kg	1 day	141 days (SE 30.)	Sundström et al. 2012
Cynomolgus monkey, adult, F	IV	10 mg/kg	1 day	87 days (SE 27)	Sundström et al. 2012
PFBA—Nonhuman primate					
Cynomolgus monkey, adult, M	IV	10 mg/kg	1 day	40.3 hours (SD 2.4)	Chang et al. 2008b
Cynomolgus monkey, adult, F	IV	10 mg/kg	1 day	41.0 hours (SD 4.7)	Chang et al. 2008b
PFBuS—Nonhuman primate					
Cynomolgus monkey, adult, M	IV	10 mg/kg	1 day	15.0 hours (SD 9.8)	Chengelis et al. 2009
Cynomolgus monkey, adult, F	IV	10 mg/kg	1 day	8.0 hours (SD 2.0)	Chengelis et al. 2009
Cynomolgus monkey, adult, M	IV	10 mg/kg	1 day	95.2 hours (SE 27.1)	Olsen et al. 2009
Cynomolgus monkey, adult, F	IV	10 mg/kg	1 day	83.2 hours (SE 41.9)	Olsen et al. 2009
PFOA—Rat					
Rat (CR), adult, M	Oral	11.4 mg/kg	1 day	115 hours	Johnson and Ober 1980
Rat (Sprague-Dawley), adult, M	Oral	0.1 mg/kg	1 day	202 hours (SD 38)	Kemper 2003
Rat (Sprague-Dawley), adult, M	Oral	1 mg/kg	1 day	138 hours (SD 32)	Kemper 2003
Rat (Sprague-Dawley), adult, M	Oral	1 mg/kg	1 day	44 hours	Kim et al. 2016b
Rat (Sprague-Dawley), adult, M	Oral	5 mg/kg	1 day	174 hours (SD 29)	Kemper 2003
Rat (Sprague-Dawley), adult, M	Oral	25 mg/kg	1 day	157 hours (SD 38)	Kemper 2003
Rat (Sprague-Dawley), adult, M	IV	1 mg/kg	1 day	185 hours (SD 19)	Kemper 2003
Rat (Sprague-Dawley), adult, M	IV	1 mg/kg	1 day	39 hours	Kim et al. 2016b
Rat (Sprague-Dawley), adult, M	Oral	0.4 mg/kg	1 day	322 hours (SD 38)	Benskin et al. 2009
Rat (Sprague-Dawley), adult, M	Oral	0.022 mg/kg/day	12 weeks	218 hours (95% CL 127–792)	De Silva et al. 2009
Rat (Wistar), adult, M	IV	21.5 mg/kg	1 day	136 hours (SD 24)	Kudo et al. 2002
Rat (Wistar), adult, M	IV	20.1 mg/kg	1 day	135 hours (SD 29)	Ohmori et al. 2003

3. TOXICOKINETICS, SUSCEPTIBLE POPULATIONS, BIOMARKERS, CHEMICAL INTERACTIONS

Table 3-5. Summary Elimination Half-Lives for Perfluoroalkyls Estimated in Humans and Experimental Animals

Species, age, and sex	Route	Dose	Exposure duration ^a	Elimination half-life ^b	Reference
Rat (Sprague-Dawley), adult, M	IP	3.9 mg/kg	1 day	216 hours (SE 30.9)	Vanden Heuvel et al. 1991c
Rat (Wistar), adult, M	IP	50 mg/kg	1 day	105 hours	Ylinen et al. 1990
Rat (Sprague-Dawley), adult, F	Oral	0.1 mg/kg	1 day	3.2 hours (SD 0.9)	Kemper 2003
Rat (Sprague-Dawley), adult, F	Oral	1 mg/kg	1 day	3.5 hours (SD 1.1)	Kemper 2003
Rat (Sprague-Dawley), adult, F	Oral	1 mg/kg	1 day	3.6 hours	Kim et al. 2016b
Rat (Sprague-Dawley), adult, F	Oral	5 mg/kg	1 day	4.6 hours (SD 0.6)	Kemper 2003
Rat (Sprague-Dawley), adult, F	Oral	25 mg/kg	1 day	16.2 hours (SD 9.9)	Kemper 2003
Rat (Sprague-Dawley), adult, F	IV	1 mg/kg	1 day	2.8 hours (SD 0.5)	Kemper 2003
Rat (Sprague-Dawley), adult, F	IV	1 mg/kg	1 day	4.6 hours	Kim et al. 2016b
Rat (Wistar), adult, F	IV	21.5 mg/kg	1 day	1.9 hours (SD 0.7)	Kudo et al. 2002
Rat (Wistar), adult, F	IV	20.1 mg/kg	1 day	1.9 hours (SD 0.7)	Ohmori et al. 2003
Rat (Sprague-Dawley), adult, F	IP	3.9 mg/kg	1 day	2.9 hours (SE 0.2)	Vanden Heuvel et al. 1991c
Rat (Wistar), adult, F	IP	50 mg/kg	1 day	24 hours	Ylinen et al. 1990
PFOS—Rat					
Rat (Sprague-Dawley), adult, M	Oral	4.2 mg/kg	1 day	179 hours	Johnson and Ober 1979
Rat (Sprague-Dawley), adult, M	Oral	0.27 mg/kg	1 day	809 hours	Benskin et al. 2009
Rat (Sprague-Dawley), adult, M	Oral	0.023 mg/kg/day	12 weeks	1,968 hours (95% CL 1.584–2.568)	De Silva et al. 2009
Rat (Sprague-Dawley), adult, M	Oral	2 mg/kg	1 day	1,495 hours (SE 50)	Chang et al. 2012
Rat (Sprague-Dawley), adult, M	Oral	2 mg/kg	1 day	635 hours	Kim et al. 2016b
Rat (Sprague-Dawley), adult, M	Oral	15 mg/kg	1 day	1,707 hours (SE 270)	Chang et al. 2012
Rat (Sprague-Dawley), adult, F	Oral	0.023 mg/kg/day	12 weeks	1,992 hours (95% CL 1,752–2,280)	De Silva et al. 2009
Rat (Sprague-Dawley), adult, F	Oral	2 mg/kg	1 day	919 hours (SE 56)	Chang et al. 2012
Rat (Sprague-Dawley), adult, F	Oral	2 mg/kg	1 day	564 hours	Kim et al. 2016b
Rat (Sprague-Dawley), adult, F	Oral	15 mg/kg	1 day	989 hours (SE 48)	Chang et al. 2012

3. TOXICOKINETICS, SUSCEPTIBLE POPULATIONS, BIOMARKERS, CHEMICAL INTERACTIONS

Table 3-5. Summary Elimination Half-Lives for Perfluoroalkyls Estimated in Humans and Experimental Animals

Species, age, and sex	Route	Dose	Exposure duration ^a	Elimination half-life ^b	Reference
Rat (Sprague-Dawley), adult, M	IV	2 mg/kg	1 day	689 hours	Kim et al. 2016b
Rat (Sprague-Dawley), adult, F	IV	2 mg/kg	1 day	595 hours	Kim et al. 2016b
PFOSA—Rat					
Rat (Sprague-Dawley), adult, M	Oral	5.0 mg/kg	1 day	125 hours	Seacat and Luebker 2000
PFDeA—Rat					
Rat (Sprague-Dawley), adult, M	IP	4.8 mg/kg	1 day	1,008 hours	Vanden Heuvel et al. 1991b
Rat (Wistar), adult, M	IV	25 mg/kg	1 day	958 hours (SD 207)	Ohmori et al. 2003
Rat (Wistar), adult, F	IV	25 mg/kg	1 day	1,406 hours (SD 140)	Ohmori et al. 2003
Rat (Sprague-Dawley), adult, F	IP	4.8 mg/kg	1 day	552 hours	Vanden Heuvel et al. 1991b
PFNA—Rat					
Rat (Sprague-Dawley), adult, M	Oral	0.2 mg/kg	1 day	974 hours	Benskin et al. 2009
Rat (Sprague-Dawley), adult, M	Oral	0.029 mg/kg/day	12 weeks	1,128 hours (95% CL 935–1,416)	De Silva et al. 2009
Rat (Sprague-Dawley), adult M	Oral	1, 3, or 10 mg/kg	1 day	734.4 hours	Tatum-Gibbs et al. 2011
Rat (Wistar), adult, M	IV	22.6 mg/kg	1 day	710 hours (SD 55)	Ohmori et al. 2003
Rat (Sprague-Dawley), adult F	Oral	1, 3, or 10 mg/kg	1 day	33.6 hours	Tatum-Gibbs et al. 2011
Rat (Wistar), adult, F	IV	22.6 mg/kg	1 day	58.6 hours (SD 9.8)	Ohmori et al. 2003
PFHpA—Rat					
Rat (Wistar), adult, M	IV	17.7 mg/kg	1 day	2.4 hours (SD 1.2)	Ohmori et al. 2003
Rat (Wistar), adult, F	IV	17.7 mg/kg	1 day	1.2 hours (SD 0.2)	Ohmori et al. 2003
PFHxA—Rat					
Rat (Sprague-Dawley), adult, M	IV	10 mg/kg	1 day	1.0 hour	Chengelis et al. 2009
Rat (Sprague-Dawley), adult, M	Oral	50 mg/kg	1 day	2.2 hours	Chengelis et al. 2009
Rat (Sprague-Dawley), adult, M	Oral	150 mg/kg	1 day	2.4 hours	Chengelis et al. 2009
Rat (Sprague-Dawley), adult, M	Oral	300 mg/kg	1 day	2.5 hours	Chengelis et al. 2009
Rat (Sprague-Dawley), adult, F	IV	10 mg/kg	1 day	0.42 hour	Chengelis et al. 2009

3. TOXICOKINETICS, SUSCEPTIBLE POPULATIONS, BIOMARKERS, CHEMICAL INTERACTIONS

Table 3-5. Summary Elimination Half-Lives for Perfluoroalkyls Estimated in Humans and Experimental Animals

Species, age, and sex	Route	Dose	Exposure duration ^a	Elimination half-life ^b	Reference
Rat (Sprague-Dawley), adult, F	Oral	50 mg/kg	1 day	2.6 hours	Chengelis et al. 2009
Rat (Sprague-Dawley), adult, F	Oral	150 mg/kg	1 day	2.2 hours	Chengelis et al. 2009
Rat (Sprague-Dawley), adult, F	Oral	300 mg/kg	1 day	2.1 hours	Chengelis et al. 2009
PFHxS—Rat					
Rat (Sprague-Dawley), adult, M	Oral	0.030 mg/kg	1 day	382 hours	Benskin et al. 2009
Rat (Sprague-Dawley), adult, M	Oral	4 mg/kg	1 day	645.6 hours	Kim et al. 2016b
Rat (Sprague-Dawley), adult, F	Oral	4 mg/kg	1 day	41.28 hours	Kim et al. 2016b
Rat (Sprague-Dawley), adult, M	IV	4 mg/kg	1 day	496.8 hours	Kim et al. 2016b
Rat (Sprague-Dawley), adult, M	IV	10 mg/kg	1 day	688 hours (SE 14.4)	Sundström et al. 2012
Rat (Sprague-Dawley), adult, F	IV	4 mg/kg	1 day	21.12 hours	Kim et al. 2016b
Rat (Sprague-Dawley), adult, F	IV	10 mg/kg	1 day	39 hours (SE 1.9)	Sundström et al. 2012
PFBA—Rat					
Rat (Sprague-Dawley), adult, M	Oral	30 mg/kg	1 day	9.22 hours (SE 0.75)	Chang et al. 2008b
Rat (Sprague-Dawley), adult, M	IV	30 mg/kg	1 day	6.38 hours (SE 0.53)	Chang et al. 2008b
Rat (Sprague-Dawley), adult, F	Oral	30 mg/kg	1 day	1.76 hours (SE 0.26)	Chang et al. 2008b
Rat (Sprague-Dawley), adult, F	IV	30 mg/kg	1 day	1.03 hours (SE 0.03)	Chang et al. 2008b
PFBuS—Rat					
Rat (Sprague-Dawley), adult, M	IV	10 mg/kg	1 day	2.1 hours	Chengelis et al. 2009
Rat (Sprague-Dawley), Rat (SD), adult, M	IV	30 mg/kg	1 day	4.51 hours (SE 2,22)	Olsen et al. 2009
Rat (Sprague-Dawley), adult, M	Oral	30 mg/kg	1 day	4.68 hours (SE 0.07)	Olsen et al. 2009
Rat (Sprague-Dawley), adult, F	IV	10 mg/kg	1 day	0.64 hours	Chengelis et al. 2009
Rat (Sprague-Dawley), adult, F	IV	30 mg/kg	1 day	3.96 hours (SE 0.21)	Olsen et al. 2009

3. TOXICOKINETICS, SUSCEPTIBLE POPULATIONS, BIOMARKERS, CHEMICAL INTERACTIONS

Table 3-5. Summary Elimination Half-Lives for Perfluoroalkyls Estimated in Humans and Experimental Animals

Species, age, and sex	Route	Dose	Exposure duration ^a	Elimination half-life ^b	Reference
Rat (Sprague-Dawley), adult, F	Oral	30 mg/kg	1 day	7.42 hours (SE 0.79)	Olsen et al. 2009
PFOS—Mouse					
Mouse (CD), adult, M	Oral	1 mg/kg	1 day	1,027 hours	Chang et al. 2012
Mouse (CD), adult, M	Oral	20 mg/kg	1 day	874 hours	Chang et al. 2012
Mouse (CD), adult, F	Oral	1 mg/kg	1 day	907 hours	Chang et al. 2012
Mouse (CD), adult, F	Oral	20 mg/kg	1 day	731 hours	Chang et al. 2012
PFHxS—Mouse					
Mouse (CD), adult, M	Oral	1 mg/kg	1 day	732 hours	Sundström et al. 2012
Mouse (CD), adult, M	Oral	20 mg/kg	1 day	671 hours	Sundström et al. 2012
Mouse (CD), adult, F	Oral	1 mg/kg	1 day	597 hours	Sundström et al. 2012
Mouse (CD), adult, F	Oral	20 mg/kg	1 day	643 hours	Sundström et al. 2012
PFNA—Mouse					
Mouse (CD-1), adult M	Oral	1 or 10 mg/kg	1 day	823.2–1,653.6 hours	Tatum-Gibbs et al. 2011
Mouse (CD-1), adult F	Oral	1 or 10 mg/kg	1 day	619.2–1,641.6 hours	Tatum-Gibbs et al. 2011
PFBA—Mouse					
Mouse (CD1), adult, M	Oral	10 mg/kg	1 day	13.34 hours (SE 4.55)	Chang et al. 2008b
Mouse (CD1), adult, M	Oral	30 mg/kg	1 day	16.3 hours (SE 7.2)	Chang et al. 2008b
Mouse (CD1), adult, M	Oral	100 mg/kg	1 day	5.22 hours (SE 2.27)	Chang et al. 2008b
Mouse (CD1), adult, F	Oral	10 mg/kg	1 day	2.87 hours (SE 0.30)	Chang et al. 2008b
Mouse (CD1), adult, F	Oral	30 mg/kg	1 day	3.08 hours (SE 0.26)	Chang et al. 2008b
Mouse (CD1), adult, F	Oral	100 mg/kg	1 day	2.79 hours (SE 0.3)	Chang et al. 2008b

3. TOXICOKINETICS, SUSCEPTIBLE POPULATIONS, BIOMARKERS, CHEMICAL INTERACTIONS

Table 3-5. Summary Elimination Half-Lives for Perfluoroalkyls Estimated in Humans and Experimental Animals

Species, age, and sex	Route	Dose	Exposure duration ^a	Elimination half-life ^b	Reference
PFOS—Rabbit					
Rabbit (New Zealand), adult, F	Oral	0.085 mg/kg/day	102 days	87 days (SD 31)	Tarazona et al. 2016

^aExposure durations of 1 day indicate that a single dose was administered.

^bReported half-lives are arithmetic means for the terminal elimination phase if multiple elimination phases were observed.

CI = confidence interval; CL = confidence limit; F = female; GM = geometric mean; IP = intraperitoneal; IV = intravenous; M = male; NA = not applicable; PFBA = perfluorobutyric acid; PFDeA = perfluorodecanoic acid; PFHpA = perfluoroheptanoic acid; PFHxS = perfluorohexane sulfonic acid; PFNA = perfluorononanoic acid; PFOA = perfluorooctanoic acid; PFOS = perfluorooctane sulfonic acid; PFOSA = perfluorooctane sulfonamide; SD = standard deviation; SE = standard error

Table 3-6. Summary Systemic Clearance for Perfluoroalkyls Estimated in Experimental Animals

Species, age, and sex	Route	Dose (mg/kg)	Exposure duration	Systemic clearance (mL/day/kg) ^a	Reference
PFOA—Nonhuman primate					
Cynomolgus monkey, adult, M	IV	10	1 day	12.4 (SD 7.4)	Butenhoff et al. 2004c
Cynomolgus monkey, adult, F	IV	10	1 day	5.3 (SD 3.3)	Butenhoff et al. 2004c
PFOS—Nonhuman primate					
Cynomolgus monkey, adult, M	IV	2	1 day	1.10 (SE 0.06)	Chang et al. 2012
Cynomolgus monkey, adult, F	IV	2	1 day	1.65 (SE 0.04)	Chang et al. 2012
PFHxA—Nonhuman primate					
Cynomolgus monkey, adult, M	IV	10	1 day	569	Chengelis et al. 2009
Cynomolgus monkey, adult, F	IV	10	1 day	535	Chengelis et al. 2009
PFHxS—Nonhuman primate					
Cynomolgus monkey, adult, M	IV	10	1 day	1.3 (SE 0.1)	Sundström et al. 2012
Cynomolgus monkey, adult, F	IV	10	1 day	1.9 (SE 0.4)	Sundström et al. 2012

3. TOXICOKINETICS, SUSCEPTIBLE POPULATIONS, BIOMARKERS, CHEMICAL INTERACTIONS

Table 3-6. Summary Systemic Clearance for Perfluoroalkyls Estimated in Experimental Animals

Species, age, and sex	Route	Dose (mg/kg)	Exposure duration	Systemic clearance (mL/day/kg) ^a	Reference
PFBA—Nonhuman primate					
Cynomolgus monkey, adult, M	IV	10	1 day	2,371 (SE 293)	Chang et al. 2008a
Cynomolgus monkey, adult, F	IV	10	1 day	1,075 (SE 91)	Chang et al. 2008a
PFBuS—Nonhuman primate					
Cynomolgus monkey, adult, M	IV	10	1 day	159	Chengelis et al. 2009
Cynomolgus monkey, adult, F	IV	10	1 day	238	Chengelis et al. 2009
Cynomolgus monkey, adult, M	IV	10	1 day	12,264 (SE 3384)	Olsen et al. 2009
Cynomolgus monkey, adult, F	IV	10	1 day	8,832 (SE 2880)	Olsen et al. 2009
PFOA—Rat					
Rat (Sprague-Dawley), adult, M	Oral	0.1	1 day	23.1 (SD 5.8)	Kemper 2003
Rat (Sprague-Dawley), adult, M	Oral	1	1 day	20.9 (SD 3.8)	Kemper 2003
Rat (Sprague-Dawley), adult, M	Oral	1	1 day	40.40 (SD 2.29)	Kim et al. 2016b
Rat (Sprague-Dawley), adult, M	Oral	5	1 day	20.4 (SD 5.0)	Kemper 2003
Rat (Sprague-Dawley), adult, M	Oral	25	1 day	27.1 (SD 7.4)	Kemper 2003
Rat (Sprague-Dawley), adult, M	IV	1	1 day	21.5 (SD 2.0)	Kemper 2003
Rat (Sprague-Dawley), adult, M	IV	1	1 day	47.39 (SD 3.40)	Kim et al. 2016b
Rat (Sprague-Dawley), adult, F	Oral	0.1	1 day	778 (SD 144)	Kemper 2003
Rat (Sprague-Dawley), adult, F	Oral	1	1 day	655 (SD 173)	Kemper 2003
Rat (Sprague-Dawley), adult, F	Oral	1	1 day	645.12 (SD 43.44)	Kim et al. 2016b
Rat (Sprague-Dawley), adult, F	Oral	5	1 day	1,164 (SD 118)	Kemper 2003
Rat (Sprague-Dawley), adult, F	Oral	25	1 day	842 (SD 166)	Kemper 2003
Rat (Sprague-Dawley), adult, F	IV	1	1 day	816 (SD 221)	Kemper 2003
Rat (Sprague-Dawley), adult, F	IV	1	1 day	612.84 (SD 32.54)	Kim et al. 2016b

3. TOXICOKINETICS, SUSCEPTIBLE POPULATIONS, BIOMARKERS, CHEMICAL INTERACTIONS

Table 3-6. Summary Systemic Clearance for Perfluoroalkyls Estimated in Experimental Animals

Species, age, and sex	Route	Dose (mg/kg)	Exposure duration	Systemic clearance (mL/day/kg) ^a	Reference
Rat (Wistar), adult, M	IV	21.5	1 day	50.4 (SD 14.4)	Kudo et al. 2002
Rat (Wistar), adult, F	IV	21.5	1 day	2,233 (SD 805)	Kudo et al. 2002
Rat (Wistar), adult, M	IV	20.1	1 day	135 (SD 29)	Ohmori et al. 2003
Rat (Wistar), adult, F	IV	20.1	1 day	2,233 (SD 805)	Ohmori et al. 2003
PFOS—Rat					
Rat (Sprague-Dawley), adult, M	Oral	2	1 day	7.33 (SD 0.55)	Kim et al. 2016b
Rat (Sprague-Dawley), adult, M	Oral	2	1 day	11.3 (SE 0.56)	Chang et al. 2012
Rat (Sprague-Dawley), adult, M	Oral	15	1 day	4.9 (SE 0.52)	Chang et al. 2012
Rat (Sprague-Dawley), adult, M	IV	2	1 day	9.24 (SD 0.37)	Kim et al. 2016b
Rat (Sprague-Dawley), adult, F	Oral	2	1 day	8.52 (SD 0.37)	Kim et al. 2016b
Rat (Sprague-Dawley), adult, F	Oral	2	1 day	22.2 (SE 0.28)	Chang et al. 2012
Rat (Sprague-Dawley), adult, F	Oral	15	1 day	5.4 (SE 20)	Chang et al. 2012
Rat (Sprague-Dawley), adult, F	IV	2	1 day	9.82 (SD 0.21)	Kim et al. 2016b
PFDeA—Rat					
Rat (Wistar), adult, M	IV	25	1 day	207 (SD 0.054)	Ohmori et al. 2003
Rat (Wistar), adult, F	IV	25	1 day	140 (SD 0.008)	Ohmori et al. 2003
PFNA—Rat					
Rat (Wistar), adult, M	IV	22.6	1 day	6.9 (SD 0.6)	Ohmori et al. 2003
Rat (Wistar), adult, F	IV	22.6	1 day	106 (SD 31)	Ohmori et al. 2003
PFHpA—Rat					
Rat (Wistar), adult, M	IV	17.7	1 day	1,604 (SD 558)	Ohmori et al. 2003
Rat (Wistar), adult, F	IV	17.7	1 day	3,071 (SD 781)	Ohmori et al. 2003
PFHxA—Rat					
Rat (Sprague-Dawley), adult, M	IV	10	1 day	2,784	Chengelis et al. 2009
Rat (Sprague-Dawley), adult, F	IV	10	1 day	18,600	Chengelis et al. 2009
PFHxS—Rat					
Rat (Sprague-Dawley), adult, M	Oral	4	1 day	7.15 (SD 0.06)	Kim et al. 2016b
Rat (Sprague-Dawley), adult, M	IV	4	1 day	9.01 (SD 0.05)	Kim et al. 2016b

3. TOXICOKINETICS, SUSCEPTIBLE POPULATIONS, BIOMARKERS, CHEMICAL INTERACTIONS

Table 3-6. Summary Systemic Clearance for Perfluoroalkyls Estimated in Experimental Animals

Species, age, and sex	Route	Dose (mg/kg)	Exposure duration	Systemic clearance (mL/day/kg) ^a	Reference
Rat (Sprague-Dawley), adult, M	IV	10	1 day	6.7 (SE 0.06)	Sundström et al. 2012
Rat (Sprague-Dawley), adult, F	Oral	4	1 day	124.83 (SD 3.40)	Kim et al. 2016b
Rat (Sprague-Dawley), adult, F	IV	4	1 day	227.93 (SD 6.73)	Kim et al. 2016b
Rat (Sprague-Dawley), adult, F	IV	10	1 day	53.4 (SE 4.38)	Sundström et al. 2012
PFBA—Rat					
Rat (Sprague-Dawley), adult, M	IV	30	1 day	851 (SE 61)	Chang et al. 2008a
Rat (Sprague-Dawley), adult, F	IV	30	1 day	2,949 (SE 59)	Chang et al. 2008a
Rat (Sprague-Dawley), adult, M	Oral	30	1 day	494 (SE 29)	Chang et al. 2008a
Rat (Sprague-Dawley), adult, F	Oral	30	1 day	1,527 (SE 145)	Chang et al. 2008a
PFBS—Rat					
Rat (Sprague-Dawley), adult, M	IV	10	1 day	946	Chengelis et al. 2009
Rat (Sprague-Dawley), adult, F	IV	10	1 day	7,464	Chengelis et al. 2009
Rat (Sprague-Dawley), adult, M	IV	30	1 day	2,856 (SE 816)	Olsen et al. 2009
Rat (Sprague-Dawley), adult, F	IV	30	1 day	11,265 (SE 960)	Olsen et al. 2009
PFOA—Mouse					
Mouse (FVB/NJcl), adult, M	IV	0.13	1 day	14.2 (SD 8.4)	Fujii et al. 2015a, 2015b
Mouse (FVB/NJcl), adult, F	IV	0.13	1 day	11.8 (SD 6.1)	Fujii et al. 2015a, 2015b
Mouse (FVB/NJcl), adult, M	Oral	1.3	1 day	13.1 (SD 7.4)	Fujii et al. 2015a, 2015b
Mouse (FVB/NJcl), adult, F	Oral	1.3	1 day	9.0 (SD 1.9)	Fujii et al. 2015a, 2015b
PFOS—Mouse					
Mouse (CD), adult, M	Oral	1	1 day	4.7	Chang et al. 2012
Mouse (CD), adult, M	Oral	20	1 day	4.7	Chang et al. 2012
Mouse (CD), adult, F	Oral	1	1 day	5.0	Chang et al. 2012
Mouse (CD), adult, F	Oral	20	1 day	6.0	Chang et al. 2012
PFHxS—Mouse					
Mouse (CD), adult, M	Oral	1	1 day	2.9	Sundström et al. 2012

3. TOXICOKINETICS, SUSCEPTIBLE POPULATIONS, BIOMARKERS, CHEMICAL INTERACTIONS

Table 3-6. Summary Systemic Clearance for Perfluoroalkyls Estimated in Experimental Animals

Species, age, and sex	Route	Dose (mg/kg)	Exposure duration	Systemic clearance (mL/day/kg) ^a	Reference
Mouse (CD), adult, M	Oral	20	1 day	4.8	Sundström et al. 2012
Mouse (CD), adult, F	Oral	1	1 day	2.7	Sundström et al. 2012
Mouse (CD), adult, F	Oral	20	1 day	3.8	Sundström et al. 2012
PFNA—Mouse					
Mouse (FVB/NJcl), adult, M	IV	0.14	1 day	3.9 (SD 1.9)	Fujii et al. 2015a, 2015b
Mouse (FVB/NJcl), adult, F	IV	0.14	1 day	5.1 (SD 2.3)	Fujii et al. 2015a, 2015b
Mouse (FVB/NJcl), adult, M	Oral	1.4	1 day	4.0 (SD 1.7)	Fujii et al. 2015a, 2015b
Mouse (FVB/NJcl), adult, F	Oral	1.4	1 day	2.4 (SD 1.0)	Fujii et al. 2015a, 2015b
PFDeA—Mouse					
Mouse (FVB/NJcl), adult, M	IV	0.16	1 day	2.2 (SD 0.9)	Fujii et al. 2015a, 2015b
Mouse (FVB/NJcl), adult, F	IV	0.16	1 day	2.8 (SD 1.2)	Fujii et al. 2015a, 2015b
Mouse (FVB/NJcl), adult, M	Oral	1.6	1 day	3.9 (SD 1.8)	Fujii et al. 2015a, 2015b
Mouse (FVB/NJcl), adult, F	Oral	1.6	1 day	2.2 (SD 1.1)	Fujii et al. 2015a, 2015b
PFUA—Mouse					
Mouse (FVB/NJcl), adult, M	IV	0.17	1 day	2.8 (SD 1.0)	Fujii et al. 2015a, 2015b
Mouse (FVB/NJcl), adult, F	IV	0.17	1 day	3.4 (SD 1.5)	Fujii et al. 2015a, 2015b
Mouse (FVB/NJcl), adult, M	Oral	1.7	1 day	5.7 (SD 2.6)	Fujii et al. 2015a, 2015b
Mouse (FVB/NJcl), adult, F	Oral	1.7	1 day	3.1 (SD 1.7)	Fujii et al. 2015a, 2015b
PFDoA—Mouse					
Mouse (FVB/NJcl), adult, M	IV	0.19	1 day	4.4 (SD 1.6)	Fujii et al. 2015a, 2015b
Mouse (FVB/NJcl), adult, F	IV	0.19	1 day	4.8 (SD 2.4)	Fujii et al. 2015a, 2015b
Mouse (FVB/NJcl), adult, M	Oral	1.9	1 day	9.4 (SD 4.1)	Fujii et al. 2015a, 2015b
Mouse (FVB/NJcl), adult, F	Oral	1.9	1 day	5.2 (SD 3.2)	Fujii et al. 2015a, 2015b

Table 3-6. Summary Systemic Clearance for Perfluoroalkyls Estimated in Experimental Animals

Species, age, and sex	Route	Dose (mg/kg)	Exposure duration	Systemic clearance (mL/day/kg) ^a	Reference
PFBA—Mouse					
Mouse (CD1), adult, M	Oral	10	1 day	280 (SE 72)	Chang et al. 2008b
Mouse (CD1), adult, M	Oral	30	1 day	296 (SE 640)	Chang et al. 2008b
Mouse (CD1), adult, M	Oral	100	1 day	784 (SE 112)	Chang et al. 2008b
Mouse (CD1), adult, F	Oral	10	1 day	564 (SE 24)	Chang et al. 2008b
Mouse (CD1), adult, F	Oral	30	1 day	696 (SE 32)	Chang et al. 2008b
Mouse (CD1), adult, F	Oral	100	1 day	1,336 (SE 64)	Chang et al. 2008b

^aAs reported in units of mL/day/kg or converted from mL/hour (x24), mL/hour (x24/body weight) or mL/minute (x60x24).

CI = confidence interval; F = female; IV = intravenous; M = male; PFBA = perfluorobutyric acid; PFBuS = perfluorobutane sulfonic acid; PFDeA = perfluorodecanoic acid; PFHpA = perfluoroheptanoic acid; PFHxA = perfluorohexanoic acid; PFHxS = perfluorohexane sulfonic acid; PFNA = perfluorononanoic acid; PFOA = perfluorooctanoic acid; PFOS = perfluorooctane sulfonic acid; SD = standard deviation; SE = standard error

Elimination of Perfluoroalkyls in Humans. Elimination $t_{1/2}$ values for PFOA, PFOS, PFHxS, PFBA, and PFBuS have been estimated in humans (Bartell et al. 2010; Costa et al. 2009; Chang et al. 2008a; Glynn et al. 2012; Harada et al. 2005a; Li et al. 2018; Olsen et al. 2007a, 2009; Seals et al. 2011; Spliethoff et al. 2008; Yeung et al. 2013; Wong et al. 2014, 2015; Worley et al. 2017a; Zhang et al. 2013). Estimates in humans are based on measurements of the decline in serum perfluoroalkyl concentrations following cessation or an abrupt decrease in exposure, or on measurements of renal plasma clearance from serum in a general population sample from Japan (Harada et al. 2005a). The latter clearance estimates were converted to $t_{1/2}$ values, for display in Table 3-5 as follows (Equations 3-4 and 3-5):

$$k_e = \frac{Cl}{V} \quad \text{Eq. (3-4)}$$

$$t_{1/2} = \frac{\ln(2)}{k_e} \quad \text{Eq. (3-5)}$$

where k_e is the elimination rate constant (e.g., day⁻¹), Cl is the renal plasma clearance (e.g., mL plasma/day/kg), and V is the plasma volume (L/kg), which is assumed to be 4.3% of body weight (ICRP 1981). In general, these studies show that longer chain length is associated with slower elimination rates. For example, the elimination $t_{1/2}$ for PFBA was estimated to be 70–80 hours (Chang et al. 2008a), whereas the $t_{1/2}$ values for PFHxS, PFOS, and PFOA range from 2 to 35 years (Bartell et al. 2010; Harada et al. 2005a; Li et al. 2018; Olsen et al. 2007a; Seals et al. 2011; Worley et al. 2017a; Zhang et al. 2013). Longer $t_{1/2}$ values for PFOA have been reported with longer monitoring follow-up times, which allow the

3. TOXICOKINETICS, SUSCEPTIBLE POPULATIONS, BIOMARKERS, CHEMICAL INTERACTIONS

detection of slower elimination phases of multiphasic elimination kinetics (Seals et al. 2011).

Perfluoroalkyl sulfonates are eliminated more slowly in humans than corresponding carboxylates of the same chain length (Zhang et al. 2013). Analytical methods typically used to measure serum perfluoroalkyls do not discriminate between linear and branched isomers and, as a result, these studies estimate elimination rates for the isomer mixture. A study that compared elimination rates of isomers of PFOA found that linear isomers tend to be eliminated more slowly than branched isomers (Zhang et al. 2013), consistent with results of studies conducted in rats (Benskin et al. 2009; De Silva et al. 2009).

An analysis of serum PFOS data from NHANES indicated that $t_{1/2}$ in females may be shorter (4.3 years) compared to males (4.7 years; Wong et al. 2014, 2015). The NHANES data are cross-sectional and, therefore, the estimates of $t_{1/2}$ required fitting the data to age patterns of PFOS intake. An improved fit to the data for females was achieved when estimated losses of PFOS in menstrual fluids were considered, suggesting that menstrual loss of PFOS may account for some, but not all, of the sex difference in the elimination rate (Verner and Longnecker 2015; Wong et al. 2015). Li et al. (2018) also found apparent sex differences in PFOS elimination in male and female residents in Sweden exposed to contaminated drinking water. The estimated $t_{1/2}$ for PFOS were 4.6 years in males and 3.1 years in females. Zhang et al. (2013) estimated serum $t_{1/2}$ for various age and sex strata in a population of 86 individuals. Serum $t_{1/2}$ for PFOS was lower for PFOS in younger females (≤ 50 years, $t_{1/2} = 6.2 \text{ years} \pm 0.3 \text{ SE}$, $n=66$) compared to males and older females ($t_{1/2} = 27 \text{ years} \pm 3.1 \text{ SE}$, $n=20$). Zhang et al. (2013) attributed the difference in serum $t_{1/2}$ to clearance in menstrual fluids. However, the estimated serum $t_{1/2}$ of 27 years is much higher than values calculated from other studies; Zhang et al. (2013) noted that the serum $t_{1/2}$ should be considered as an upper limit estimate. Estimated $t_{1/2}$ for PFOA was not different in younger females ($2.1 \pm 0.3 \text{ SE}$, $n=20$) compared to males and older females ($2.6 \pm 0.4 \text{ SE}$, $n=66$). Declines in serum PFOA concentrations were observed in populations following initiation of activated carbon filtration of public water supplies that had been contaminated with PFOA (Bartell et al. 2010). The estimated mean serum $t_{1/2}$ for a group of 200 adults followed for 1 year after filtration was initiated was 2.3 years (95% CI 2.1–2.4). Elimination rates were not different in males and females. Serum PFOA concentration ranged from 16 to 1,200 ng/mL. A larger follow-up study measured serum PFOA concentrations in two populations of former residents ($n=1,672$) of the same water districts (Seals et al. 2011). In one population ($n=643$), the serum $t_{1/2}$ increased with increasing elapsed time since leaving the water district. The $t_{1/2}$ values were 2.9 years (95% CI 2.3–3.8) for elapsed time of <4 years and 10.1 years for elapsed time of >4 years. In a second population with an elapsed time since residence of <9 years, the $t_{1/2}$ was 8.5 years (95% CI 7.1–10.1). Elimination rates (based on the annual percent decrease in serum concentrations) were faster in

3. TOXICOKINETICS, SUSCEPTIBLE POPULATIONS, BIOMARKERS, CHEMICAL INTERACTIONS

males (27%) compared to females (18%) for the first 4 years post-exposure; however, no difference was evident between sexes when elapsed time from exposure was >4 years.

Bartell (2012) and Russell et al. (2015) point out that most studies examining PFOA elimination half-lives fail to account for ongoing background exposure, which could result in an overestimation of elimination half-lives. Bartell (2012) estimated that the bias from background exposure could result in 1–26% overestimation of calculated PFOA half-lives and that greater overestimations can occur for half-lives based on longer follow-up times. Russell et al. (2015) estimated that the bias was greatest in populations with serum PFOA levels closest to background levels. In a re-analysis of the Olsen et al. (2007) occupational exposure data, Russell et al. (2015) estimated that overestimation was approximately 1.2% in workers with initial serum concentrations >500 ng/mL (100 times higher than NHANES general population data) and 13% for workers with lower initial serum PFOA levels. Restricting the elimination half-life calculation to workers with initial serum PFOA levels of >500 ng/mL would result in a half-life of 3.0 years (Russell et al. 2015), compared to 3.8 years calculated for the whole cohort (Olsen et al. 2007).

Analysis of kinetics of serum PFOS concentrations in retired U.S. fluorochemical production workers (24 males, 2 females) yielded a mean serum elimination $t_{1/2}$ estimate of 5.4 years (95% CI 3.9–6.9; geometric mean: 4.8 years, 95% CI 4.0–5.8) in subjects whose serum PFOS concentrations ranged from 37 to 3,490 ng/mL (Olsen et al. 2007a). Estimates for the two females in the same study were 4.9 and 6.8 years. Estimates based on renal clearance of PFOS from serum in subjects from the general population of Japan ranged from 2.9 to 7.4 years; these subjects had serum PFOS concentrations that ranged from 4 to 49 ng/mL (Harada et al. 2005a). Estimates in males (7.4, 2.9 years) were similar to females (4.5, 4.6 years). This same study measured serum PFHxS concentrations in retired U.S. fluorochemical production workers (24 males, 2 females) and yielded a mean estimate of 8.5 years (95% CI 6.4–10.6; geometric mean: 7.3 years, 95% CI 5.8–9.2) for the serum elimination $t_{1/2}$ in subjects whose serum PFHxS concentrations ranged from 10 to 1,295 ng/mL (Olsen et al. 2007a). Estimates for the two females in the same study were 12.2 and 13.3 years.

The elimination rate of PFBA was estimated in fluorochemical workers who may have been exposed to various PFBA precursors (Chang et al. 2008a). In three male workers, the estimated mean $t_{1/2}$ based on serum PFBA kinetics was 81 hours (± 41 SD). In a larger study of nine workers (seven males, two females), the mean $t_{1/2}$ was 72 hours (± 38 SD). Estimates for the two female subjects were 56 and 118 hours. The combined mean value for the 12 estimates was 75 hours (± 38 SD). Olsen et al. (2009)

3. TOXICOKINETICS, SUSCEPTIBLE POPULATIONS, BIOMARKERS, CHEMICAL INTERACTIONS

estimated serum $t_{1/2}$ of PFBuS in six fluorochemical workers. The mean $t_{1/2}$ was 27.4 days (± 11.1 SD). The group included a single female whose $t_{1/2}$ was 45.7 days. Based on these observations, PFBA and PFBuS are eliminated substantially faster in humans than perfluoroalkyls having longer carbon chain lengths (e.g., PFHxS, PFOA, PFOS).

Temporal trends in perfluoroalkyl serum concentrations have also been used to estimate population halving times (Glynn et al. 2012; Olsen et al. 2012; Spleithoff et al. 2008; Yeung et al. 2013). Population halving times are influenced by temporal trends in intakes and may therefore not accurately reflect clearance. Population halving times for PFOS ranged from 4 to 5 years (Olsen et al. 2012; Spleithoff et al. 2008; Yeung et al. 2013). Glynn et al. (2012) monitored serum perfluoroalkyls in a population of pregnant women ($n=413$) in Sweden over the period 1996–2010. Halving times were 22 years (95% CI 16–38) for PFOA and 8.2 years (95% CI 6.3–12) for PFOS.

Elimination of Perfluoroalkyls in Nonhuman Primates. Elimination $t_{1/2}$ values and systemic clearances for PFOA, PFOS, PFHxA, PFHxS, PFBA, and PFBuS have been estimated in *Cynomolgus* monkeys (Buttenoff et al. 2004c; Chang et al. 2012; Chengelis et al. 2009; Olsen et al. 2009; Seacat et al. 2002; Sundström et al. 2012). Estimated terminal $t_{1/2}$ values were 20–30 days for PFOA, 100–170 days for PFOS, 90–140 days for PFHxS, 40 hours for PFBA and 8–95 hours for PFBuS. Elimination of perfluoroalkyls in monkeys is multiphasic and, as a result, estimates of the terminal $t_{1/2}$ can vary with the duration of the observation period and assumptions made in modeling elimination kinetics (Chang et al. 2012; Chengelis et al. 2009; Olsen et al. 2009; Sundström et al. 2012). For example, the $t_{1/2}$ values for PFBuS were 8 and 15 hours in female and male monkeys, respectively, when monkeys were monitored for 48 hours following a single intravenous dose (Chengelis et al. 2009), whereas the $t_{1/2}$ values were 95 and 83 hours in male and female monkeys, respectively, when the monitoring period was extended to 14 days and a three-compartment model was used to estimate the terminal $t_{1/2}$ (Olsen et al. 2009). Studies in monkeys confirm general trends observed in humans that perfluoroalkyl sulfonates are more slowly eliminated than perfluoroalkyl carboxylates and that elimination of longer-chain perfluoroalkyls occurs more slowly than short-chain perfluoroalkyls. Systemic clearances were lower for PFOS, PFHxS, and PFBuS compared to the corresponding carboxylates, PFOA, PFHxA, and PFBA (Table 3-6). Systemic clearances were similar in male and female monkeys (Table 3-6).

Elimination of Perfluoroalkyls in Rats. Elimination $t_{1/2}$ values and systemic clearances for PFOA, PFOS, PFOSA, PFDeA, PFNA, PFHpA, PFHxA, PFHxS, PFBA, and PFBuS have been estimated in rats (Benskin et al. 2009; Chang et al. 2008b, 2012; Chengelis et al. 2009; De Silva et al. 2009; Johnson and

3. TOXICOKINETICS, SUSCEPTIBLE POPULATIONS, BIOMARKERS, CHEMICAL INTERACTIONS

Ober 1979; Kemper 2003; Kim et al. 2016b; Kudo et al. 2002; Ohmori et al. 2003; Olsen et al. 2009; Seacat and Luebker 2000; Sundström et al. 2012; Vanden Heuvel et al. 1991b, 1991c; Ylinen et al. 1990). Consistent with observations made in humans and Cynomolgus monkeys, perfluoroalkyl sulfonates are more slowly eliminated than perfluoroalkyl carboxylates and short-chain perfluoroalkyls (e.g., PFBA, PFBS) are eliminated faster in rats than long-chain perfluoroalkyls (e.g., PFOA, PFOS, PFHxA, PFHxS); Tables 3-5 and 3-6. Linear PFOA isomers tend to be eliminated more slowly than branched isomers (Benskin et al. 2009; De Silva et al. 2009).

Elimination of perfluoroalkyls exhibits pronounced sex differences in rats, with faster elimination in females than in males (Benskin et al. 2009; Chang et al. 2008b; Chengelis et al. 2009; Kemper 2003; Kim et al. 2016b; Kudo et al. 2002; Ohmori et al. 2003; Sundström et al. 2012; Tatim-Gibbs et al. 2011; Vanden Heuvel et al. 1991c; Ylinen et al. 1990). Estimates of systemic clearance for PFOA in male rats ranged from 20 to 50 mL/day/kg, whereas estimates for female rats ranged from 600 to 2,200 mL/day/kg (Kemper 2003; Kudo et al. 2002; Ohmori et al. 2003). Systemic clearances of PFOA, PFOS, PFNA, PFHxA, PFHxS, PFBA, and PFBS are also higher in female rats compared to male rats (Table 3-6). Pronounced sex difference in elimination rates in rats (faster elimination in females) was observed in rats following 30-minute nose-only exposures to aerosols (MMAD=1.9–2.1 μm) of 1–25 mg ammonium PFOA/m³ (Hinderliter et al. 2006a). Plasma PFOA concentrations were not detectable 12 hours after exposure of female rats, and were approximately 90% of peak plasma concentrations 24 hours after the exposure in male rats. The slower elimination of PFOA in male rats resulted in steady-state plasma concentrations within 3 weeks of repeated exposures (6 hours/day, 5 days/week) in male rats, whereas in female rats, daily periodic oscillations of plasma concentrations from peak to below detection occurred on each day of exposure. Steady-state plasma concentrations in male rats were approximately 10 times that of daily peak concentrations in female rats.

Pronounced dose dependence appears in the $t_{1/2}$ estimates for PFOA in female rats. With increasing dose, plasma elimination kinetics in female rats converts from monophasic to biphasic. Following an oral dose of PFOA of 0.1, 1, 5, or 25 mg/kg, the terminal $t_{1/2}$ values in female rats were 3.2, 3.5, 4.6, or 16.2 hours, respectively; no apparent dose dependence was observed in male rats over the same dose range (Kemper 2003). Dose-dependent elimination of PFOA has been attributed to a capacity-limited renal tubular secretion of PFOA in female rats (see discussion below on *Mechanisms of Excretion*). The divergence in elimination kinetics between male and female rats appears to be age-dependent, with faster elimination becoming evident in female rats after 30 days of age, consistent with the timing of sexual maturation and

3. TOXICOKINETICS, SUSCEPTIBLE POPULATIONS, BIOMARKERS, CHEMICAL INTERACTIONS

involvement of sex hormones in the modulation of the renal excretion of PFOA in rats (Hinderliter et al. 2006b).

Elimination of Perfluoroalkyls in Mice. Elimination $t_{1/2}$ values and systemic clearances for PFOS, PFHxS, and PFBA have been estimated in mice (Chang et al. 2008a, 2012; Sundström et al. 2012). Consistent with studies conducted in rats and monkeys, PFBA is eliminated more rapidly in mice than PFOS and PFHxS. Systemic clearances ranged from 5 to 6 mL/day/kg for PFOS (Chang et al. 2012), from 3 to 5 mL/day/kg for PFHxS (Sundström et al. 2012), and from 300 to 1,300 mL/day/kg for PFBA (Chang et al. 2008a). Sex differences in elimination in mice were observed for PFBA, but not PFOS or PFHxS. Systemic clearances of PFBA in female mice were approximately 2 times that of males (Chang et al. 2008a). Systemic clearance of PFBA in male and female mice appeared to be dependent on dose. Systemic clearance following a single oral dose of 100 mg PFBA/kg was approximately 2 times higher than the systemic clearance following a dose of 10 or 30 mg PFBA/kg. Possible explanations for the apparent dependence of clearance on dose are dose-dependent bioavailability or that the one-compartment model used to estimate elimination rates and serum AUC did not adequately fit the serum kinetics observed at the higher dose (Chang et al. 2008a). The latter could occur if renal tubular reabsorption of PFBA or plasma protein binding of PFBA is saturable in mice. Systemic clearance rates for PFOA were similar in male mice (13.1 mL/kg/day) and in female mice (9.0 mL/kg/day) (Fuji et al. 2015a, 2015b).

Elimination of Perfluoroalkyls in Other Species. Sex differences in elimination of PFOA have also been observed in hamsters; unlike the rat, male hamsters excreted absorbed PFOA more rapidly than female hamsters. Following a single gavage dose of 10 mg/kg as ammonium [^{14}C]PFOA, cumulative excretion of ^{14}C in urine at 24 hours post-dosing was 96.4% of the dose in female rats and 8.7% in male rats; 24.6% and 84.5% in female and male hamsters, respectively; 4.1% in male and female mice; and 90.5 and 80.2% in female and male rabbits, respectively (Hundley et al. 2006).

Mechanisms of Excretion. Urinary excretion of perfluoroalkyls involves glomerular filtration and renal tubular secretion and reabsorption (for PFOA, see Harada et al. 2005a; Kudo et al. 2002; Ohmori et al. 2003). Glomerular filtration of PFOA is limited by extensive binding of PFOA to albumin and other high molecular weight proteins in plasma (Han et al. 2003, 2005; Ohmori et al. 2003; Kerstner-Wood et al. 2003; Vanden Heuvel et al. 1992a, 1992b; Ylinen and Auriola 1990). Elimination of PFOA and other perfluoroalkyls shows pronounced sex differences in rats, with slower elimination in males for PFOA, PFOS, PFNA, PFHxA, PFHxS, PFBA, and PFBuS (Chang et al. 2008a, 2012; Chengelis et al. 2009; Kemper 2003; Kudo et al. 2002; Ohmori et al. 2003; Sundström et al. 2012). The sex difference in PFOA

3. TOXICOKINETICS, SUSCEPTIBLE POPULATIONS, BIOMARKERS, CHEMICAL INTERACTIONS

elimination in rats is dependent on testosterone (Hinderliter et al. 2006b; Kudo et al. 2002; Vanden Heuvel et al. 1992a). The significantly slower elimination of PFOA in adult male rats compared to female rats has been attributed to sex hormone modulation of organic anion transporters in kidney. At similar doses administered to male and female rats, PFOA undergoes net tubular reabsorption in male rats (i.e., urinary excretion rate < rate of glomerular filtration of PFOA) and net tubular secretion in female rats (i.e., urinary excretion rate > rate of glomerular filtration of PFOA) (Harada et al. 2005a; Kudo et al. 2002; Ohmori et al. 2003). In rats, several transporters have been shown to have affinity for C7–C9 perfluoroalkyl carboxylates. The transporters, OAT1 and OAT3, located on the basolateral membrane of the renal proximal tubule, appear to participate in secretion of C7–C9 perfluoroalkyl carboxylates into the tubular fluid (Nakagawa et al. 2008; Weaver et al. 2010). The transporters, OATP1a1 (rat), OAT4 (human), and URAT1 (human), located on the apical membrane, appear to mediate reabsorption of C8–C10 perfluoroalkyl carboxylates from the tubular fluid (Katakura et al. 2007; Nakagawa et al. 2009; Weaver et al. 2010; Yang et al. 2009, 2010). In rats and mice, expression of OAT1, OAT3, and OATP1a1 is controlled by male sex hormones and shows higher activities in males (Buist and Klaassen 2004; Gotoh et al. 2002; Kobayashi et al. 2002; Li et al. 2002; Lu et al. 1996; Lubojevic et al. 2004). The slower elimination of PFOA (and other long-chain perfluoroalkyl carboxylates) in male rats has been attributed to OATP1a1 (Weaver et al. 2010; Yang et al. 2009). Higher activity of OATP1a1 in male rats results in higher reabsorptive transport and lower rates of urinary excretion. Affinities of OATP1a1 (rat), OAT4 (human), and URAT1 (human) are highest for C7–C10 perfluoroalkyl carboxylates (Weaver et al. 2010; Yang et al. 2009, 2010). Affinity of rat OATP1a1 is strongly correlated with total clearance in rats ($r^2=0.98$; Yang et al. 2009).

Although sex differences for elimination of perfluoroalkyls have been detected in laboratory animals, human monitoring studies have not consistently detected sex differences in elimination $t_{1/2}$ of perfluoroalkyls; this may reflect limitations in the studies, including numbers and age of subjects (Bartell et al. 2010; Seals et al. 2011; Wong et al. 2014, 2015; Zhang et al. 2013). Menstruation may contribute to faster elimination of PFOS in women (Wong et al. 2014, 2015; Zhang et al. 2013). The effect of menstruation or other variables related to menstruation appear to contribute to faster elimination in younger (≤ 50 years) women compared to men and older women (Zhang et al. 2013). Two studies have found evidence for elimination of PFOS being affected by menstruation (Wong et al. 2014, 2015; Zhang et al. 2013). The estimated $t_{1/2}$ for PFOA was not different in younger females compared to males and older females. Mechanisms by which menstruation could affect PFOS clearance are not understood. Bulk elimination of blood would be expected to affect serum clearance of both PFOS and PFOA; therefore, other mechanisms must contribute that discriminate between perfluoroalkyl species. A better

3. TOXICOKINETICS, SUSCEPTIBLE POPULATIONS, BIOMARKERS, CHEMICAL INTERACTIONS

metric than serum $t_{1/2}$ for evaluating sex differences in elimination for this would be systemic or renal clearance of the perfluoroalkyl compound. Harada et al. (2005a) measured renal clearance in a small sample of young adults (five males and five females, age 22–23 years) and found that renal clearance was not different in males and females. Zhang et al. (2013) estimated renal clearance of PFOA and PFOS in a population of younger females (≤ 50 years, $n=20$), older females (>50 years), younger males (≤ 50 years), and older males (>50 years) and did not find significant sex or age differences. Studies that measured systemic clearance in monkeys also have not found significant sex differences in systemic clearance of PFOA (Buttenoff et al. 2004c) or PFOS (Chang et al. 2012).

Studies conducted in rats have shown that PFDeA, PFNA, PFOA, PFOS, and PFHxA are secreted in bile and undergo extensive reabsorption from the gastrointestinal tract (Johnson et al. 1984; Kudo et al. 2001; Vanden Heuvel et al. 1991b, 1991c). Biliary secretion rates of PFOA are similar in male and female rats when renal excretion is blocked by ligation of the kidneys (Vanden Heuvel et al. 1991a, 1991b). This lack of sex influence on biliary secretion (compared to the sex influence on renal clearance) may reflect a relative sex insensitivity of OAT2 (or other organic anion transporter) expression in liver, compared to kidney; the latter is approximately 7–8 times higher in adult female rats compared to male rats (Kudo et al. 2002).

3.1.5 Physiologically Based Pharmacokinetic (PBPK)/Pharmacodynamic (PD) Models

PBPK models use mathematical descriptions of the uptake and disposition of chemical substances to quantitatively describe the relationships among critical biological processes (Krishnan et al. 1994). PBPK models are also called biologically based tissue dosimetry models. PBPK models are increasingly used in risk assessments, primarily to predict the concentration of potentially toxic moieties of a chemical that will be delivered to any given target tissue following various combinations of route, dose level, and test species (Clewel and Andersen 1985). Physiologically based pharmacodynamic (PBPD) models use mathematical descriptions of the dose-response function to quantitatively describe the relationship between target tissue dose and toxic endpoints.

Several PBPK models of PFOA and PFOS have been reported. These include a human model for PFOA and PFOS (Fàbrega et al. 2014, 2016; Loccisano et al. 2011; Worley et al. 2017b), models for PFOA and PFOS in monkeys (Loccisano et al. 2011), models for PFOA and PFOS in rats (Harris and Barton 2008; Loccisano et al. 2012a, 2012b; Tan et al. 2008; Worley and Fisher 2015a, 2015b), and a model for PFOA in mice (Rodriguez et al. 2009). Models of PFOA and PFOS kinetics during gestation and lactation in rats and mice also have been reported (Loccisano et al. 2012a, 2012b; Rodriguez et al. 2009). Various

3. TOXICOKINETICS, SUSCEPTIBLE POPULATIONS, BIOMARKERS, CHEMICAL INTERACTIONS

empirical and compartmental models have also been reported (Hoffman et al. 2011; Lorber and Egeghy 2011; Lou et al. 2009; Thompson et al. 2010; Verner et al. 2016; Wambaugh et al. 2013; Wu et al. 2009). Tardiff et al. (2009) utilized a human pharmacokinetic model to estimate an average daily oral dose corresponding to a Reference Dose for PFOA plasma concentration in humans. Cheng and Ng (2017) developed a permeability-limited PBPK model for PFOA in male rats that could be used for *in vitro* to *in vivo* extrapolation. PBPK models were not identified for other perfluoroalkyls examined in this profile. Given the toxicokinetic differences between compounds, the PFOA and PFOS PBPK models may not be appropriate for other compounds.

3.1.5.1 Loccisano et al. (2012a, 2012b) Rat Models

Loccisano et al. (2012a) developed a model for simulating the kinetics of PFOA and PFOS in male and female rats. The model was based, in part, on a multi-compartmental model developed by Tan et al. (2008; Andersen et al. 2006). The female rat model (Loccisano et al. 2012a) was subsequently extended to include gestation and lactation (Loccisano et al. 2012b). The general structures of the models are depicted in Figures 3-3, 3-4, and 3-5. Complete lists of parameters and parameter values and the bases for parameter values and evaluations of model predictions in comparison to observations are described in Loccisano et al. (2012a, 2012b).

The basic (i.e., adult nonpregnant rat) model includes compartments representing plasma (including a bound and free fraction), kidney and renal glomerular filtrate, liver, and a lumped compartment representing all other tissues. Two storage compartments are included in the model: one receives perfluoroalkyl from the gastrointestinal tract (unabsorbed) and liver (bile) and the other receives perfluoroalkyl from the glomerular filtrate. The storage compartments were included in the model to simulate time delays between elimination from plasma and appearance of perfluoroalkyl in feces or urine. Absorption from the gastrointestinal tract is simulated as the balance between first-order absorption and fecal excretion of unabsorbed chemical. Absorbed PFOA and PFOS are assumed to be delivered to the liver where saturable binding of PFOS (but not PFOA) to liver proteins occurs. Saturable binding of PFOS in liver was included to simulate the relatively long retention times of PFOS in liver that have been observed in rats. Exchanges between PFOA or PFOS in liver (free fraction), kidney, and other tissues with the free pool in plasma are assumed to be flow-limited (governed by blood flow) with equilibrium determined by the tissue:blood partition coefficient. PFOA and PFOS in plasma are simulated as instantaneous distributions into free and bound fractions. Extensive binding of PFOA and PFOS to plasma proteins has been demonstrated in various animal species including rats (see Section 3.1.2). For

3. TOXICOKINETICS, SUSCEPTIBLE POPULATIONS, BIOMARKERS, CHEMICAL INTERACTIONS

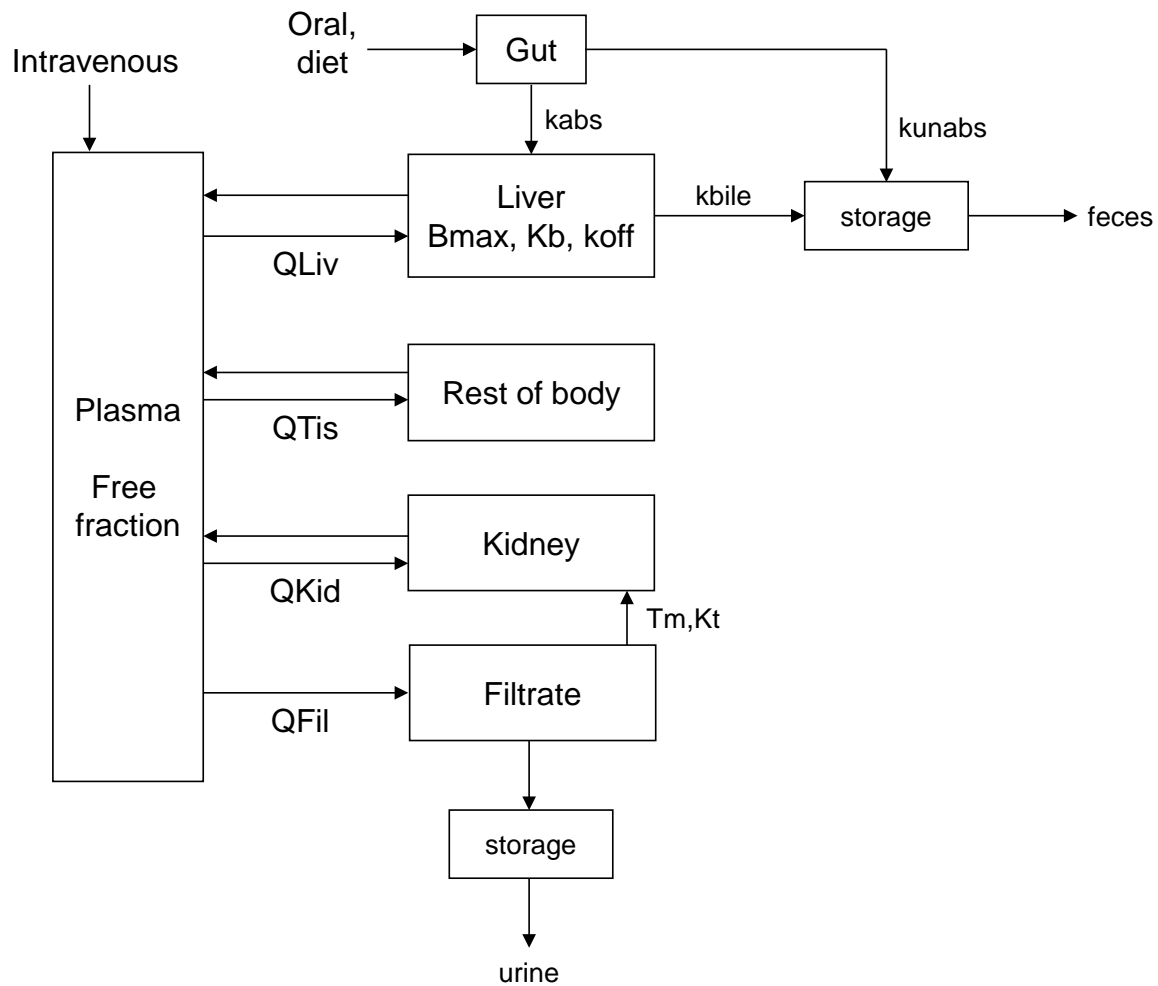
Figure 3-3. Structure of PBPK Model of PFOA and PFOS in the Rat

Bmax = liver binding capacity; kabs = first-order absorption rate constant; Kb = liver binding affinity constant; kbile = biliary excretion rate constant; Koff = liver binding dissociation constant; Kt = affinity constant; kunabs = rate of unabsorbed dose to appear in feces; PBPK = physiologically based pharmacokinetic; PFOA = perfluorooctanoic acid; PFOS = perfluorooctane sulfonic acid; QFil = clearance from plasma to glomerular filtrate; QKid = blood flow in and out of kidney; QLiv = blood flow in and out of liver; QTis = blood flow in and out of tissues; Tm = transporter maximum

Source: Loccisano et al. 2012a (reproduced with permission of Elsevier Inc. in the format reuse in a government report via Copyright Clearance Center; Reproductive Toxicology by Reproductive Toxicology Center; Washington, DC)

3. TOXICOKINETICS, SUSCEPTIBLE POPULATIONS, BIOMARKERS, CHEMICAL INTERACTIONS

Figure 3-4. PBPK Model Structure for Simulating PFOA and PFOS Exposure During Gestation in the Rat (Dam, Left; Fetus, Right)

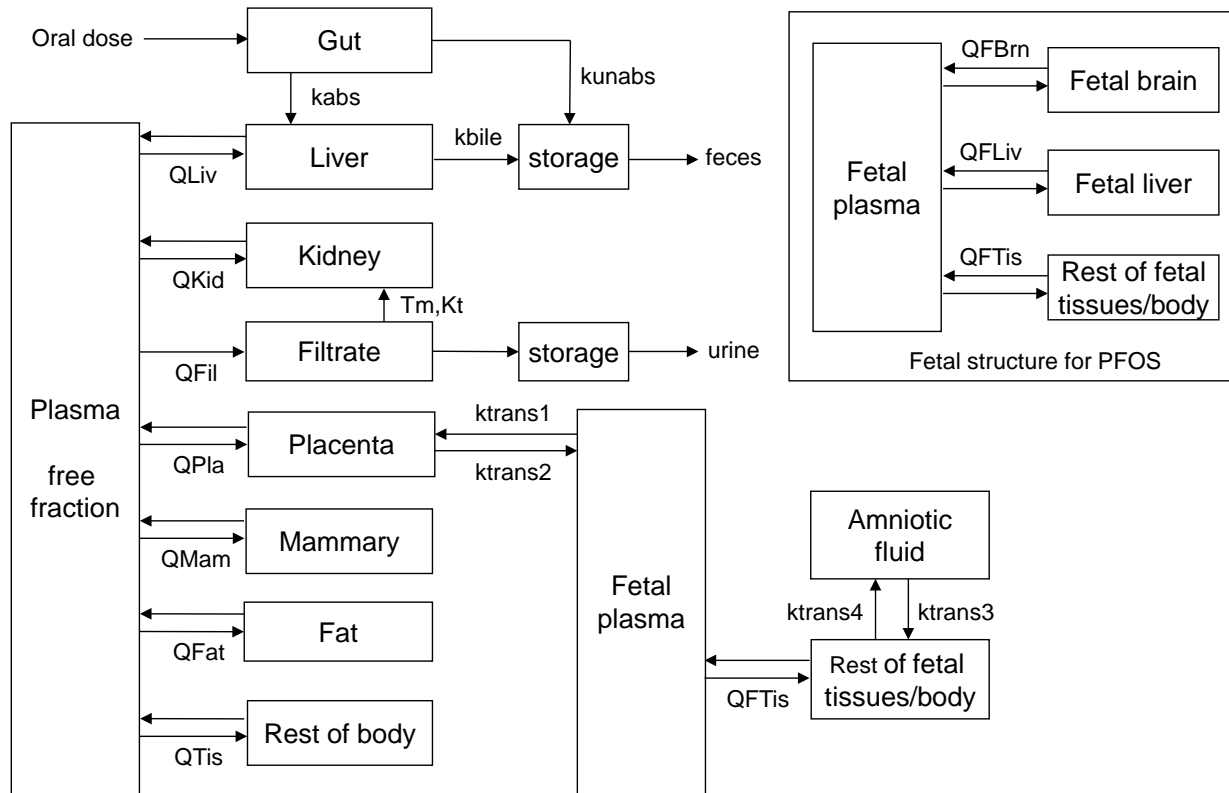

kabs = first-order absorption rate constant; kbile = biliary excretion rate constant; Kt = affinity constant; ktrans1/ktrans 2 = transfer between placenta and fetal plasma; ktrans3/ktrans4 = transfer between amniotic fluid and rest of the body; kunabs = rate of unabsorbed dose to appear in feces; PBPK = physiologically based pharmacokinetic; PFOA = perfluorooctanoic acid; PFOS = perfluorooctane sulfonic acid; QFat = blood flow in and out of fat; QFBrn = blood flow in and out of fetal brain; QFil = clearance from plasma to glomerular filtrate; QFLiv = blood flow in and out of fetal liver; QFTis = blood flow in and out of fetal tissue; QKid = blood flow in and out of kidney; QLiv = blood flow in and out of liver; QMam = blood flow in and out of mammary tissue; QPla = blood flow in and out of placenta; QTis = blood flow in and out of tissues; Tm = transporter maximum

Source: Loccisano et al. 2012b (reproduced with permission of Elsevier Inc. in the format reuse in a government report via Copyright Clearance Center; Reproductive Toxicology by Reproductive Toxicology Center; Washington, DC)

3. TOXICOKINETICS, SUSCEPTIBLE POPULATIONS, BIOMARKERS, CHEMICAL INTERACTIONS

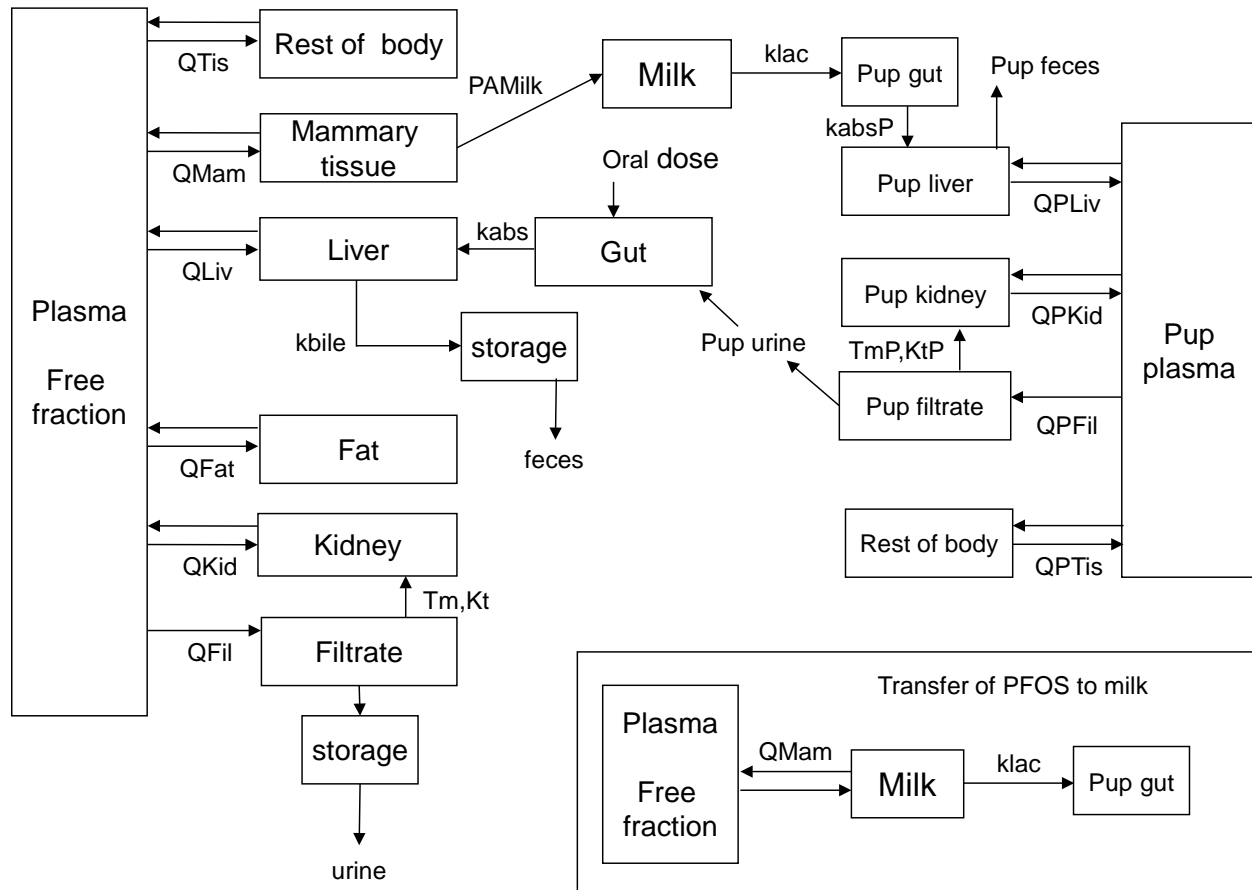
Figure 3-5. PBPK Model Structure for Simulating PFOA/PFOS Exposure During Lactation in the Rat (Dam, Left; Pup, Right)

kabs = first-order absorption rate constant; kabsP = pup first-order absorption rate constant; kbile = biliary excretion rate constant; klac = transfer to pup through milk; Kt = affinity constant; KtP = pup affinity constant; PAMilk = transfer from mammary tissue to liver; PBPK = physiologically based pharmacokinetic; PFOA = perfluorooctanoic acid; PFOS = perfluorooctane sulfonic acid; QFat = blood flow in and out of fat; QFil = clearance from plasma to glomerular filtrate; QKid = blood flow in and out of kidney; QLiv = blood flow in and out of liver; QMam = blood flow in and out of mammary tissue; QPFil = clearance from pup plasma to glomerular filtrate; QPKid = blood flow in and out of pup kidney; QPLiv = blood flow in and out of pup liver; QPTis = blood flow in and out of pup tissue; QTis = blood flow in and out of tissues; Tm = transporter maximum; TmP = pup transporter maximum

Source: Loccisano et al. 2012b (reproduced with permission of Elsevier Inc. in the format reuse in a government report via Copyright Clearance Center; Reproductive Toxicology by Reproductive Toxicology Center; Washington, DC)

3. TOXICOKINETICS, SUSCEPTIBLE POPULATIONS, BIOMARKERS, CHEMICAL INTERACTIONS

PFOA, the free fraction is assigned a constant of 4.5% in females and 0.6% in males. These values were optimized to fit observed kinetics of PFOA in plasma and urine of rats following intravenous and oral exposures (Loccisano et al. 2012a). Adequate fit to observed PFOS plasma kinetics following single doses of PFOS required introducing a time-dependence in binding of PFOS to protein (Loccisano et al. 2012a; Tan et al. 2008). The free fraction for PFOS in plasma decreases from an initial value (after dosing) of 2.2% to a minimum of 0.1% with a $t_{1/2}$ for the change of approximately 14 hours in a 0.25-kg rat ($k=0.035 \text{ hours}^{-1}/\text{kg}^{-0.25}$). The relatively short $t_{1/2}$ for the change limits the effects of the time-dependent plasma kinetics over the first 1–2 days of dosing (including peak concentrations) and has no effect on longer-term kinetics or steady state. Although the time-dependence of the free fraction in plasma was needed to simulate short-term plasma PFOS kinetics in rats, the physiological mechanism for a dependence of plasma binding on the time following dosing (i.e., not on concentration of PFOS in plasma or some other dose surrogate) has not been established. Elimination of absorbed chemical occurs by biliary excretion and urinary excretion. Transfer from liver to feces (representing excretion following biliary transfer) is represented as a first-order process acting on the free fraction in liver. Excretion in urine is simulated as the balance between transfer from the free fraction to the glomerular filtrate and renal tubular reabsorption, which removes PFOA and PFOS from the glomerular filtrate and returns it to kidney tissue. Renal tubular reabsorption is simulated as a capacity-limited process with parameters T_m ($\mu\text{g}/\text{hour}/\text{kg}$ body weight), representing the maximum rate of transport, and K_T ($\mu\text{g}/\text{L}$), representing affinity for the transporter (the concentration in the glomerular filtrate at which reabsorptive transport rate is half of maximum). This representation of renal tubular reabsorption is used to simulate observed sex differences in elimination of PFOA from plasma, which have been attributed to higher reabsorptive capacity in male rats (see Section 3.1.4). Values for the maximum and affinity parameters for PFOA result in higher reabsorptive clearances from the glomerular filtrate ($T_m/K_T=4.1$) in male rats compared to female rats ($T_m/K_T=0.045$), and correspondingly lower urinary clearance of PFOA from plasma in male rats. Reabsorption parameters for PFOS are the same in both sexes and result in reabsorptive clearances that are approximately twice that of PFOA in female rats ($T_m/K_T=7.2$).

The basic rat model was extended to simulate gestation with inclusion of additional compartments representing adipose and mammary tissue in the dam, placenta, and fetus (Figure 3-4); Loccisano et al. 2012b). Transfer of PFOA and PFOS to the fetus is simulated as a flow-limited transfer to the placenta, with first-order exchange between the placenta and the free fraction in fetal plasma. The free fraction in fetal plasma is simulated with as a constant fraction for PFOA and PFOS (i.e., no dependence on time as in the adult). Within the fetus, PFOA in the free fraction of plasma exchanges with a single lumped compartment representing the fetal body, which exchanges with PFOA in amniotic fluid. The fetal PFOS

3. TOXICOKINETICS, SUSCEPTIBLE POPULATIONS, BIOMARKERS, CHEMICAL INTERACTIONS

model subdivides fetal tissue into brain, liver, and a lumped compartment for other tissues, all of which undergo flow-limited exchanges with the free fraction of PFOS in fetal plasma. Binding of PFOA and PFOS in fetal liver is assumed to be negligible. Differences in the structure of the fetal models for PFOA and PFOS reflect the differences in the availability of data of for estimating parameter values for the various compartments (e.g., perfluoroalkyl concentrations in amniotic fluid, liver).

The lactation model extends the dam portion of the gestational model to include milk and pup (Figure 3-5; Loccisano et al. 2012b). Transfer of PFOA to milk occurs through the mammary gland with flow-limited exchange between plasma and mammary tissue and diffusion into milk from mammary tissue. The model also includes transfer from the pup to the dam, which occurs during maternal stimulation of the neonatal pup to induce elimination and during pup grooming. Data on PFOS in mammary tissue of rodents were not available to establish parameters for a mammary tissue compartment; therefore, the mammary tissue compartment was left out of the PFOS model, and transfer of PFOS to milk is simulated as diffusion directly from plasma. The pup model includes compartments representing the free fraction in plasma, liver, kidney, glomerular filtrate, and a lumped compartment representing all other pup tissues. This structure is essentially identical to the nonpregnant rat model (Loccisano et al. 2012a) with a few differences. Absorption from the gastrointestinal tract is assumed to be complete in pups, and binding in pup liver is assumed to be negligible in pups. There are no storage compartments for biliary or glomerular filtrate perfluoroalkyl in the pup model. Sex differences in renal tubular reabsorption of PFOA are assumed to develop in response to sexual maturation and, therefore, are not present during lactation (i.e., parameter values are allometrically scaled to pup body weight from the male rat values). Reabsorptive transport parameters for PFOS are allometrically scaled from the lactating dam. The liver/plasma partition coefficient for PFOS in the pups was set lower than that in the dam, based on observations in rats. All other parameters for PFOA and PFOS in the pup were the same or allometrically scaled from values for the dam.

Optimization of parameter values and evaluations of the rat models are described in Loccisano et al. (2012a, 2012b). Data sets utilized in developing and evaluating the nonpregnant rat models included single-dose intravenous and gavage studies and short-term feeding studies (Johnson and Ober 1979; Kemper 2003; Kudo et al. 2007; Perkins et al. 2004). Data used in development and evaluation of the gestation and lactation models included data from gestational and/or lactational exposure studies in rats (Chang et al. 2009; Hinderliter et al. 2005; Kuklennyik et al. 2004; Luebker et al. 2002, 2005a, 2005b; Thibodeaux et al. 2003).

3. TOXICOKINETICS, SUSCEPTIBLE POPULATIONS, BIOMARKERS, CHEMICAL INTERACTIONS

Applications for Dosimetry Extrapolation and Risk Assessment. The wealth of data on pharmacokinetics of PFOA and PFOS in rats allowed an extensive evaluation of the rat models for predicting plasma urinary and liver PFOA and PFOS following single intravenous or single and repeated oral dosing. Inclusion of renal tubular reabsorption parameters in the model provided accurate simulations of sex differences in elimination rates of PFOA from plasma and excretion in urine, and differences in rates of elimination of PFOA and PFOS. The gestation model successfully predicted fetal plasma and liver PFOA and PFOS at the end (or near the end) of pregnancy. Consistent with observations, the model predicts higher fetal plasma concentrations and lower fetal liver concentrations of PFOS compared to maternal, and lower internal exposure (plasma concentrations) to PFOA in the fetus compared to maternal (fetal liver data were not available for PFOA). The lactation model successfully predicted PFOA and PFOS in pup plasma following dosing of the dam. Predicted plasma concentrations of PFOA in nursing pups were approximately 10–50% lower than maternal concentrations, whereas maternal and pup concentrations of PFOS were similar. The model could be used to estimate liver doses and corresponding plasma profiles resulting from single or repeated dosing of adult male or female rats, and maternal-fetal and maternal-pup transfer of PFOA and PFOS. The rat model was evaluated with data from a 14-week oral dosing study and has not been tested for longer exposures. Harris and Barton (2008) developed a PBPK model for PFOS in the rat and found that time adjustments that increased renal clearance and decreased the liver-plasma partition coefficient as a function of time and dose improved predictions of plasma and liver PFOS in adult rats exposed for a period of 105 weeks. Although the Harris and Barton (2008) model is very different from the Loccisano et al. (2012a) model, these results suggest the possibility that clearance of PFOS may be age- and/or dose-dependent in rats. This may reflect age- or dose-related changes in kidney function, including tubular reabsorption or secretion of PFOS.

3.1.5.2 Loccisano et al. (2011, 2013) Monkey and Human Models

Loccisano et al. (2011) developed a model for simulating the kinetics of PFOA and PFOS in monkeys and humans. The human model described in Loccisano et al. (2011) was subsequently extended to include simulations of pregnancy and lactation (Loccisano et al. 2013). The monkey model was based, in part, on a multi-compartmental model developed by Tan et al. (2008; Andersen et al. 2006) for simulating the kinetics of plasma and urinary PFOA in monkeys. The structures of the monkey and human models are identical (Figure 3-6) and are very similar to the structure of the rat model (Loccisano et al. 2012a), with inclusion of compartments representing fat and skin, and absence of a storage compartment for biliary transfer. Complete lists of parameters and parameter values and the bases for parameter values

3. TOXICOKINETICS, SUSCEPTIBLE POPULATIONS, BIOMARKERS, CHEMICAL INTERACTIONS

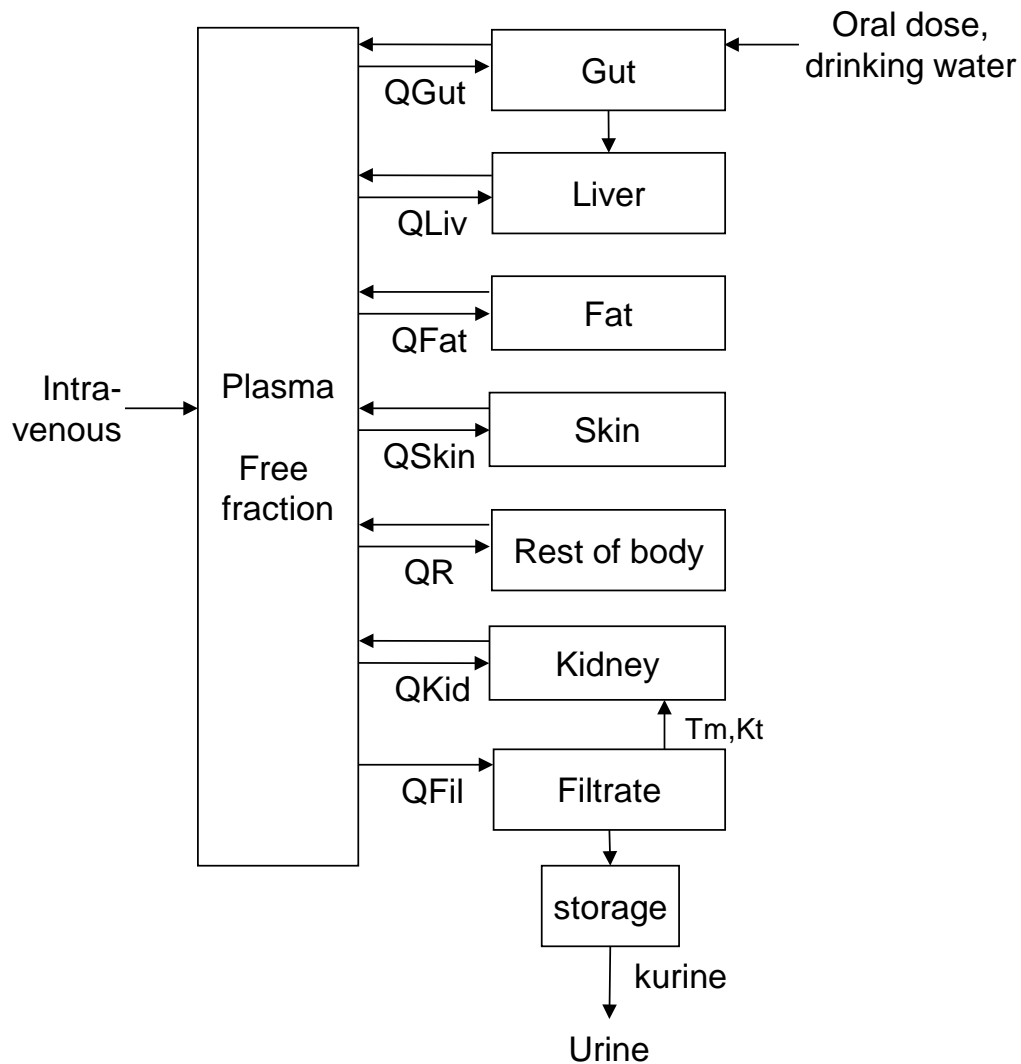
Figure 3-6. Structure of PBPK Model for PFOA and PFOS in Monkeys and Humans

K_t = half-saturation constant; k_{urine} = urinary elimination rate; PBPK = physiologically based pharmacokinetic; PFOA = perfluorooctanoic acid; PFOS = perfluorooctane sulfonic acid; Q_{Fat} = blood flow in and out of fat; Q_{fil} = clearance from plasma to glomerular filtrate; Q_{Gut} = blood flow in and out of gut; Q_{Kid} = blood flow in and out of kidney; Q_{Liv} = blood flow in and out of liver; Q_R = blood flow in and out of rest of body; Q_{Skin} = blood flow in and out of skin; T_m = transport maximum

Source: Loccisano et al. 2011 (reproduced with permission of Academic Press in the format reuse in a government report via Copyright Clearance Center; Regulatory Toxicology and Pharmacology: RTP by International Society of Regulatory Toxicology and Pharmacology)

3. TOXICOKINETICS, SUSCEPTIBLE POPULATIONS, BIOMARKERS, CHEMICAL INTERACTIONS

and evaluations of model predictions in comparison to observations are reported in Loccisano et al. (2011).

Parameters in the monkey and human models differ in several ways from the rat model. The free fraction in plasma is represented as a constant for both PFOA and PFOS; time-dependency for PFOS in the rat model is absent in the monkey and human models. The parameters for renal tubular reabsorption of PFOA and PFOS are the same for males and females. This is consistent with the absence of evidence for a sex difference in elimination kinetics in monkeys (Butenhoff et al. 2002, 2004a; Seacat et al. 2002).

Values for the affinity constant (K_T) and maximum (T_m) for tubular reabsorption were optimized to plasma concentration kinetics in monkeys. The value for K_T in monkeys was used in the human model. The value for T_m for PFOA in humans was set to yield a plasma elimination $t_{1/2}$ of 2.3 or 3.8 years. The latter two values derive from estimates of the serum $t_{1/2}$ in populations exposed to PFOA in drinking water (2.3 years; Bartell et al. 2010) or in retired fluorochemical workers (3.8 years; Olsen et al. 2007a). The value for T_m for PFOS in humans was set to yield a plasma elimination $t_{1/2}$ of 5.4 years, based on observations in retired fluorochemical workers (Olsen et al. 2007a). Binding of PFOA and PFOS in the liver was assumed to be negligible in monkeys and humans. Tissue-plasma partition coefficients used in both models were derived from observations in rodents and were the same in the monkey and human models.

Optimization of parameter values and evaluation of the monkey and human models are described in Loccisano et al. (2011). Data sets utilized in developing and evaluating the monkey model included single-dose intravenous and oral studies and repeated-dose oral studies conducted in Cynomolgus monkeys (Butenhoff et al. 2004c; Noker and Gorman 2003; Seacat et al. 2002). Data used in evaluating the human model consisted of serum measurements in people who experienced environmental exposures (Emmett et al. 2006a; Hölzer et al. 2008; Steenland et al. 2009b), adult Red Cross donors (Olsen et al. 2003b, 2008), and retired fluorochemical workers (Olsen et al. 2007a). In general, PFOA and PFOS intakes and exposure durations were not known with certainty in these populations and, as a result, these data do not yield confident evaluations of the ability of the human model to predict intake-plasma level relationships. Follow-up monitoring after a cessation or decrease in exposure can provide data that allow evaluation of the ability of the model to accurately simulate elimination kinetics. Predicted declines in serum PFOA concentrations encompassed observed group mean declines when the T_m for renal tubular reabsorption was set to yield an elimination $t_{1/2}$ of 2.3 or 3.8 years. Group mean declines in serum PFOS

3. TOXICOKINETICS, SUSCEPTIBLE POPULATIONS, BIOMARKERS, CHEMICAL INTERACTIONS

were predicted reasonably well for some populations, but not all populations, when the T_m for renal tubular reabsorption was optimized to yield an elimination $t_{1/2}$ of 5.4 years.

The human pregnancy model includes additional compartments representing the free fractions in plasma, amniotic fluid, and a lumped compartment for fetal tissue (Loccisano et al. 2013). The same conceptual approach was used in rat pregnancy model (Loccisano et al. 2012b, Figure 3-4). Rate constants for placental transfer were initially those from the rat model, adjusted to yield predicted maternal/fetal plasma ratios that agreed with observed maternal/fetal ratios in cord blood (Apelberg et al. 2007b; Fei et al. 2007; Midasch et al. 2007; Washino et al. 2009). Transfers from amniotic fluid to fetus were the same as those used in the rat model, as there were no data on which to base estimates for humans. The lactation model included additional compartments for mammary milk and a lumped compartment representing the infant. Transfer of PFOA to milk is simulated as flow-limited exchange between plasma and milk, governed by mammary tissue blood flow and a milk/plasma partition coefficient. This structure obviated the need to simulate mammary tissue kinetics, for which there were no data in humans. The milk/plasma partition coefficient was calibrated to yield predictions of observed milk/plasma ratios (Fromme et al. 2010; Kärman et al. 2007). Transfer from maternal milk to infants is the product of the milk concentration and milk production rate (assumed to be equal to sucking rate). The pregnancy model was evaluated by comparing predicted maternal/fetal plasma ratios for PFOA and PFOS with observations from various human monitoring studies (Fei et al. 2007; Fromme et al. 2010; Hanssen et al. 2010; Inoue et al. 2004; Kim et al. 2011; Midasch et al. 2007; Monroy et al. 2008; Tittlemier et al. 2004). The lactation model was evaluated by comparing predicted maternal plasma/milk ratios for PFOA and PFOS with observations from various human monitoring studies (Fromme et al. 2009; Kärman et al. 2007; Liu et al. 2011). In general, most model predictions were within plus or minus 2-fold of observations.

Applications for Dosimetry Extrapolation and Risk Assessment. The model predicts plasma concentrations and tissue levels of PFOA and PFOS following intravenous or oral dosing. A skin compartment is included in the model, which may serve for simulating absorption and distribution following deposition onto the skin surface; however, the dermal absorption model was not evaluated in Loccisano et al. (2011). The human model was calibrated to predict $t_{1/2}$ values estimated for human populations (e.g., 2.3 or 3.8 years for PFOA, 5.4 years for PFOS). As a result, comparisons made between observed and predicted serum concentrations evaluate whether or not the populations actually exhibit the $t_{1/2}$ to which the model was calibrated, and not the validity of the model to predict the internal distribution of PFOA or PFOS. It is not currently possible to assess with confidence whether the human model can accurately predict doses to liver or any other tissues. Fábrega et al. (2014) applied the human

3. TOXICOKINETICS, SUSCEPTIBLE POPULATIONS, BIOMARKERS, CHEMICAL INTERACTIONS

adult model to estimate plasma concentrations and tissue levels of PFOA and PFOS in human autopsy samples. Exposure inputs to the model were intakes of PFOA and PFOS estimated from public water supply concentrations in the local area where the subjects had resided (Catalonia, Spain) and concentrations in local market basket foods (Domingo et al. 2012a, 2012b). The human model predicted levels of PFOA in plasma and liver that were approximately 10- and 5-fold higher, respectively, than observed. Predicted plasma levels of PFOS were approximately 2-fold higher than observed and predicted levels of PFOS in kidney were approximately 25% of observed. Fábrega et al. (2014) explored alternative values for tissue/plasma partition coefficients, determined from human autopsy issues (Maestri et al. 2006). The adjusted partition coefficients improved predictions of observed tissue PFOA and PFOS levels. Although the model could be applied to predicting plasma concentrations of PFOA and PFOS or intakes associated with specific plasma concentrations (e.g., oral MRLs), it is not clear what advantages the model offers over simpler empirical or compartmental models similarly calibrated to predict the serum $t_{1/2}$. The monkey model has been more thoroughly evaluated for predicting plasma and urinary kinetics of PFOA and PFOS. This was possible because of the availability of more extensive experimental data on plasma and urine PFOA and PFOS following intravenous and oral (single and repeated) dosing in male and female monkeys. Nevertheless, data on internal distribution were not available to allow evaluation of how well the monkey model predicts doses to the liver or other tissues. Predictions of plasma PFOA and PFOS concentrations from the monkey (and human) model were highly sensitive to values assigned to the maximum rate for tubular reabsorption (T_m) and other parameters that govern urinary elimination of PFOA and PFOS (e.g., free fraction in plasma and glomerular filtration rate; Loccisano et al. 2011). Optimization of the monkey models relied heavily on adjusting these same parameters and, for the human model, the target plasma elimination $t_{1/2}$ was achieved solely by adjusting T_m . Thus, despite the complexity of the models, their potential to accurately predict plasma elimination kinetics and, therefore, steady-state plasma concentrations and associated oral intakes, depends largely on how well they predict plasma clearance. If plasma clearance and the free-fraction in plasma can be reliably predicted empirically for the animal species of interest, then far simpler compartmental models can be used for dosimetry extrapolation of steady-state free plasma concentrations.

3.1.5.3 Rodriguez et al. (2009) Mouse Model

Rodriguez et al. (2009) developed a model for simulating the maternal-fetal and maternal-pup kinetics of PFOA in mice. The general structure of the model is depicted in Figure 3-7. Complete lists of parameters and parameter values and the bases for parameter values and evaluations of model predictions in comparison to observations are reported in Rodriguez et al. (2009). The maternal, fetal, and pup

3. TOXICOKINETICS, SUSCEPTIBLE POPULATIONS, BIOMARKERS, CHEMICAL INTERACTIONS

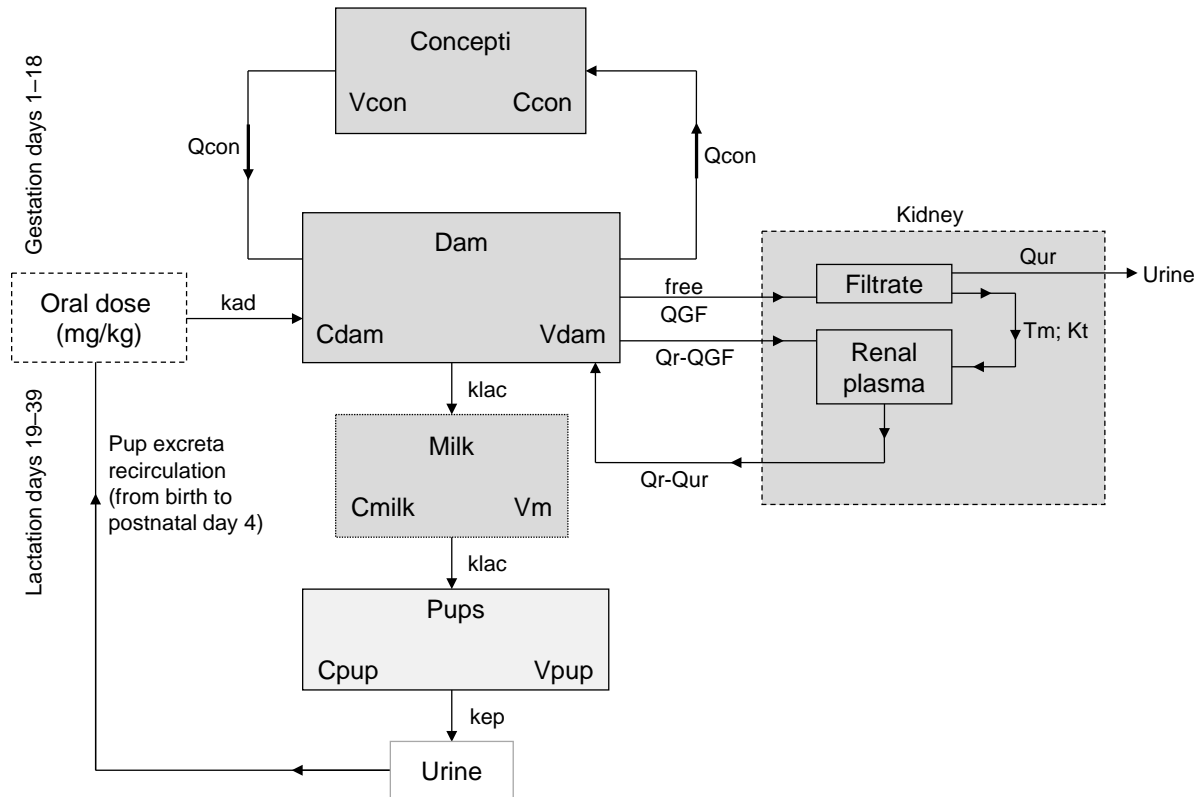
Figure 3-7. Renal Resorption Pharmacokinetic Model of Gestation and Lactation used in the Analysis of CD-1 Mice

Ccon = concentration in concepti; Cdam = concentration in dam; Cmilk = concentration in milk; Cpup = concentration in pup; kad = first-order absorption rate; kep = urinary excretion rate; klac = transfer rate via milk; Kt = half-saturation constant; Qcon = blood flow to and from placenta; QGF = glomerular filtrate; Qr = renal plasma flow; Qur = urine flow; Tm = transport maximum; Vcon = volume in concepti; Vdam = volume in dam; Vmilk = volume in milk; Vpup = volume in pup

Source: Rodriguez et al. 2009 (reproduced with permission of Elsevier Inc. in the format reuse in a government report via Copyright Clearance Center; Reproductive Toxicology by Reproductive Toxicology Center, Washington, DC)

3. TOXICOKINETICS, SUSCEPTIBLE POPULATIONS, BIOMARKERS, CHEMICAL INTERACTIONS

systems are simulated as single well-mixed compartments. Absorption from the gastrointestinal tract is simulated as first-order with complete absorption of the ingested dose. Elimination of absorbed PFOA from the maternal system is simulated as the balance between glomerular filtration and renal tubular reabsorption. The latter is represented as a saturable process with parameters T_m and K_T . Transfer to the fetus is flow-limited and governed by a fetus/maternal partition coefficient and placental blood flow. Transfer from the maternal system to the pup by lactation is simulated as first-order governed by a lactation transfer rate constant. Elimination of PFOA from the pup is first-order to urine. Data sets utilized in developing and evaluating the mouse model included oral gestational dosing studies.

Applications for Dosimetry Extrapolation and Risk Assessment. The model predicted observed concentrations of PFOA in maternal, fetal, and pup serum following oral gestational exposures to mice (Abbott et al. 2007; Lau et al. 2006; White et al. 2007). Residuals for predictions are presented, which provide a quantitative measure of how well the model predicted observations (Rodriguez et al. 2009). Similar to the rat, the mouse model predicts higher internal exposure (serum PFOA concentrations) in the maternal system compared to the fetus. It also predicts accelerated loss of PFOA from the maternal system during lactation. The model simulates the maternal, fetal, and pup systems as single compartments. Although this serves for simulating plasma concentrations (the main objective of the modeling effort), it does not allow for simulation of tissue levels of PFOA in the maternal system, fetus, or pup.

3.1.5.4. Wambaugh et al. 2013 (Andersen et al. 2006) Model

The Wambaugh et al. (2013) model is a three-compartment model based on the three-compartmental monkey model of Andersen et al. (2006). The structure of the two models are identical (Figure 3-8). Parameter values for the Wambaugh et al. (2013) model are presented in Table 3-7. The model includes a central compartment, a secondary distribution compartment, and a renal glomerular filtrate compartment. The central compartment (C1), which includes plasma, receives PFOA or PFOS from oral dosing (first-order k_a , hour^{-1}) and exchanges perfluoroalkyl with the secondary compartment (C2, which lumps all other tissues and distribution volumes into a single compartment) and with the glomerular filtrate (C3). A fraction of the perfluoroalkyl in C1 is free (Free) and available for exchange with C2 and C3. Exchanges between C1 and C2 are first order (k_{12} , k_{21} , hour^{-1}) with k_{21} assigned a value equal to the R_{V_2/V_1} , where R_{V_2/V_1} is the ratio of the volumes of the two compartments (V_2/V_1). Transfer of perfluoroalkyl into the glomerular filtrate is first order and governed by the glomerular filtration rate (Q_{filc} , L/hour). Transfer for

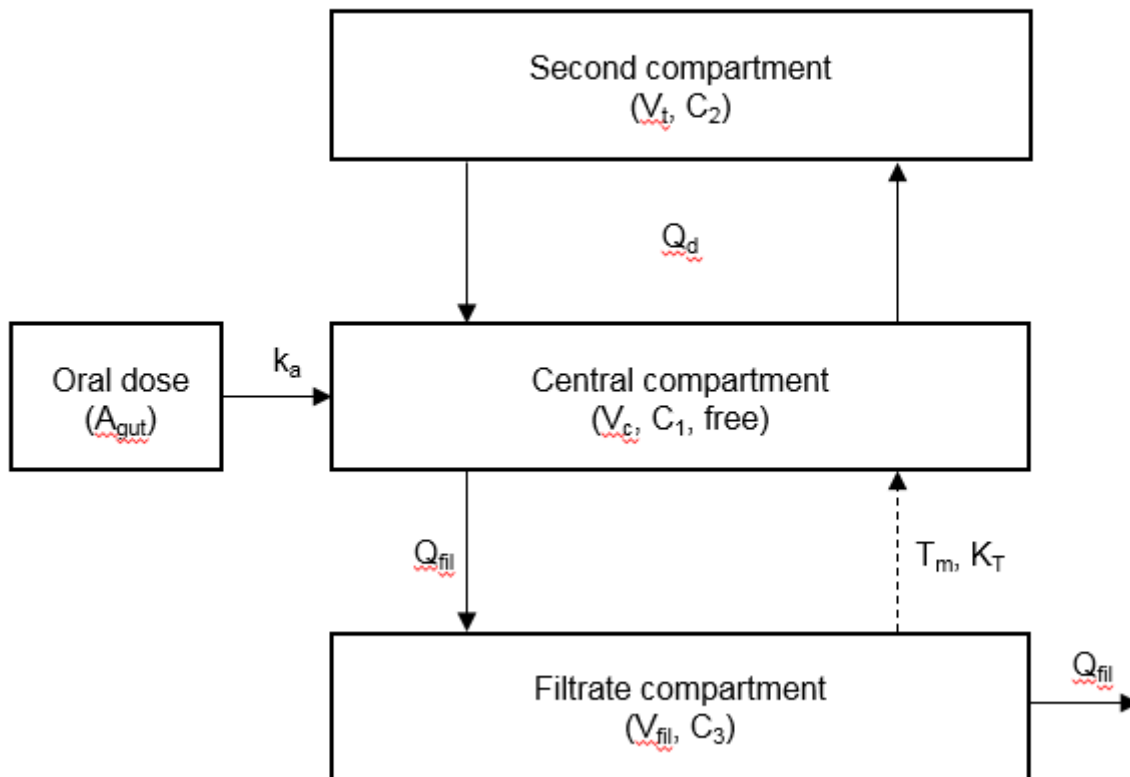
Figure 3-8. Andersen et al. (2006) Pharmacokinetic Model with Oral Absorption

A_{gut} is the amount of chemical in the gut; k_a is the first-order rate constant for absorption from the gut; Q_{fil} is the flow through the filtrate compartment; C_1 , C_2 , and C_3 are the chemical concentrations in the central, second, and filtrate compartments, respectively; V_c , V_t , and V_{fil} are the volumes of distribution of the central, second, and filtrate compartments; free is the free fraction of compound in the central compartment; Q_d is the flow between the central and second compartments; the saturable resorption process from the filtrate back into the central compartment is modeled with Michaelis-Menten kinetics, with a maximum rate $T_{maximum}$ and a half-maximum concentration K_T .

Reprinted from Wambaugh et al. (2013) by permission of Oxford University Press

3. TOXICOKINETICS, SUSCEPTIBLE POPULATIONS, BIOMARKERS, CHEMICAL INTERACTIONS

Table 3-7. Estimated and Assumed Pharmacokinetic Parameters for the Modified Andersen et al. (2006) Model for PFOA and PFOS

Reference	Species	BW (kg)	Cardiac output ^a		Parameter (units)							
			(L/hour/kg ^{0.74})	K _a (hour ⁻¹)	V _{cc} (L/kg)	k ₁₂ (hour ⁻¹)	R _{V2:V1} (unitless)	T _{maxc} (μmole/hour)	K _T (μM)	Free (unitless)	Q _{filc} (L/hour)	V _{filc} (L/kg)
PFOA^b												
Lou et al. (2009)	Mouse: CD1 (F)	0.02	8.68	290 (0.6–73,000)	0.18 (0.16–2.0)	0.021 (3.1x10 ⁻¹⁰ to 3.8x10 ⁴)	1.07 (0.26–5.84)	4.91 (1.75–2.96)	0.037 (0.0057–0.17)	0.011 (0.0026–0.051)	0.077 (0.015–0.58)	9.7x10 ⁻⁴ (3.34x10 ⁻⁹ –7.21)
Dewitt et al. (unpublished)	Mouse: C57Bl/6 (F)	0.02	8.68	340 (0.53–69,000)	0.17 (0.13–2.3)	0.35 (0.058–52)	53 (11–97)	2.7 (0.95–22)	0.12 (0.033–0.24)	0.034 (0.014–0.17)	0.017 (0.010–0.081)	7.6x10 ⁻⁵ (2.7x10 ⁻¹⁰ –6.4)
Kemper (2003)	Rat: Sprague-Dawley (F)	0.20 (0.16–0.23) ^c	12.39	1.7 (1.1–3.1)	0.14 (0.11–0.17)	0.098 (0.039–0.27)	9.2 (3.4–28)	1.1 (0.25–9.6)	1.1 (0.27–4.5)	0.086 (0.031–0.23)	0.039 (0.014–0.13)	2.6x10 ⁻⁵ (2.9x10 ⁻¹⁰ –28)
Kemper (2003)	Rat: Sprague-Dawley (M)	0.24 (0.21–0.28) ^c	12.39	1.1 (0.83–1.3)	0.15 (0.13–0.16)	0.028 (0.0096–0.08)	8.4 (3.1–23)	190 (5.5–50,000)	0.092 (3.4x10 ⁻⁴ –1.6)	0.08 (0.03–0.22)	0.22 (0.011–58)	0.0082 (1.3x10 ⁻⁸ –7.6)
Butenhoff et al. (2004b)	Monkey: Cynomolgus (M/F)	7 (m), 4.5 (f)	19.8	230 (0.27–73,000)	0.4 (0.29–0.55)	0.0011 (2.4x10 ⁻¹⁰ to 3.5x10 ⁴)	0.98 (0.25–3.8)	3.9 (0.65–9,700)	0.043 (4.3x10 ⁻⁵ –0.29)	0.01 (0.0026–0.038)	0.15 (0.02–24)	0.0021 (3.3x10 ⁻⁹ –6.9)
PFOS												
Reference	Species	BW ^d (kg)	Cardiac output ^e (L/hour/kg ^{0.74})	K _a (hour ⁻¹)	V _{cc} (L/kg)	k ₁₂ (hour ⁻¹)	R _{V2:V1} (unitless)	T _{maxc} (μmol/hour)	K _T (μM)	Free (unitless)	Q _{filc} (L/hour)	V _{filc} (L/kg)
Chang et al. (2012)	Mouse: CD1 (F)	0.02	8.68	1.16 (0.617–42,400)	0.264 (0.24–0.286)	0.0093 (2.63e-10–38,900)	1.01 (0.251–4.06)	57.9 (0.671–32,000)	0.0109 (1.44x10 ⁻⁵ –1.45)	0.00963 (0.00238–0.0372)	0.439 (0.0125–307)	0.00142 (4.4x10 ⁻¹⁰ –6.2)
Chang et al. (2012)	Mouse: CD1 (M)	0.02	8.68	433.4 (0.51–803.8)	0.292 (0.268–0.317)	2,976 (2.8e-10–4.2e4)	1.29 (0.24–4.09)	1.1e4 (2.1–7.9e4)	381 (2.6x10 ⁻⁵ –2,900)	0.012 (0.0024–0.038)	27.59 (0.012–283)	0.51 (3.5x10 ⁻¹⁰ –6.09)
Chang et al. (2012)	Rat: Sprague-Dawley (F)	0.203	12.39	4.65 (3.02–1,980)	0.535 (0.49–0.581)	0.0124 (3.1e-10–46 800)	0.957 (0.238–3.62)	1,930 (4.11–83,400)	9.49 (0.00626–11,100)	0.00807 (0.00203–0.0291)	0.0666 (0.0107–8.95)	0.0185 (8.2x10 ⁻⁷ –7.34)
Chang et al. (2012)	Rat: Sprague-Dawley (M)	0.222	12.39	0.836 (0.522–1.51)	0.637 (0.593–0.68)	0.00524 (2.86e-10–43,200)	1.04 (0.256–4.01)	1.34e-06 (1.65e-10–44)	2.45 (4.88x10 ⁻¹⁰ –60 300)	0.00193 (0.000954–0.00249)	0.0122 (0.0101–0.025)	0.000194 (1.48x10 ⁻⁹ –5.51)
Seacat et al. (2002) and Chang et al. (2012)	Monkey: Cynomolgus (M/F)	3.42	19.8	132 (0.225–72,100)	0.303 (0.289–0.314)	0.00292 (2.59e-10–34,500)	1.03 (0.256–4.05)	15.5 (0.764–4,680)	0.00594 (2.34 x10 ⁻⁵ –0.0941)	0.0101 (0.00265–0.04)	0.198 (0.012–50.5)	0.0534 (1.1x10 ⁻⁷ –8.52)

^aCardiac outputs obtained from Davies and Morris (1993).^bMeans and posterior distributions from the Bayesian Markov Chain Monte Carlo (MCMC) analysis (95% credible interval in parentheses) are reported.^cEstimated average body weight (BW) for species used except with Kemper (2003) study where individual rat weights were available and assumed to be constant.^dAverage BW for species: individual-specific BWs.^eCardiac outputs obtained from Davies and Morris (1993).

Source: Wambaugh et al. (2013)

3. TOXICOKINETICS, SUSCEPTIBLE POPULATIONS, BIOMARKERS, CHEMICAL INTERACTIONS

perfluoroalkyl from the glomerular filtrate to C1 (representing renal tubular reabsorption) is capacity limited (T_{maxc} , $\mu\text{mol/hr}$; K_T , μM). Perfluoroalkyl that is not reabsorbed is excreted.

Parameter values for the various species and strains were estimated from experimental pharmacokinetic data for each species and strain using Bayesian Markov Chain Monte Carlo (MCMC) analysis. Studies that provided data used to estimate parameter values are listed in Wambaugh et al. (2013). The parameter values shown in Table 3-7 are the mean values and posterior distributions (95% credible interval) from the MCMC analyses.

Applications for Dosimetry Extrapolation and Risk Assessment. Wambaugh et al. (2013) applied the model to predicting internal doses (mean and maximum serum concentrations and plasma AUC) for Benchmark Dose Software (BMDS) modeling and for comparing internal dosimetry from *in vivo* toxicity studies to estimates of potency (AC_{50} , maximum Efficacy) from *in vitro* studies. EPA applied the Wambaugh et al. (2013) model to deriving chronic oral reference doses (RfDs) for PFOA and PFOS (EPA 2016e, 2016f). The model was used to predict internal doses (time-integrated plasma PFOA or PFOS concentrations) achieved in toxicity studies conducted in various laboratory animal models (CD-1 mouse, C57Bl/6 mouse, Sprague-Dawley rat, Cynomolgus monkey). Plasma concentrations were then extrapolated to equivalent steady-state concentrations in humans using a model of first-order elimination of PFOA and PFOS from plasma. The same approach was used to derive MRLs for PFOA and PFOS (see Appendix A).

3.1.5.5 Harris and Barton (2008) Rat Model

Harris and Barton (2008) developed a model for simulating PFOS kinetics in adult rats. The general structure of the model is depicted in Figure 3-9. Complete lists of parameters and parameter values and the bases for parameter values and evaluations of model predictions in comparison to observations are reported in Harris and Barton (2008). The model includes systemic compartments representing blood (including a bound and free fraction of plasma and red blood cells), liver, and a lumped compartment representing all other tissues. The gastrointestinal tract is simulated as separate compartments representing the upper and lower tracts. Absorption occurs from both the upper and lower tracts, with distinct first-order rate constants assigned to each. Biliary PFOS is transferred from liver to the lower tract. Absorbed PFOS is delivered to the liver where it enters plasma to be distributed to other tissues. Exchanges between PFOS in plasma and all tissues are assumed to be diffusion-limited, with the free pool in plasma participating in the exchange with red blood cells, and the total plasma pool exchanging with liver and all

3. TOXICOKINETICS, SUSCEPTIBLE POPULATIONS, BIOMARKERS, CHEMICAL INTERACTIONS

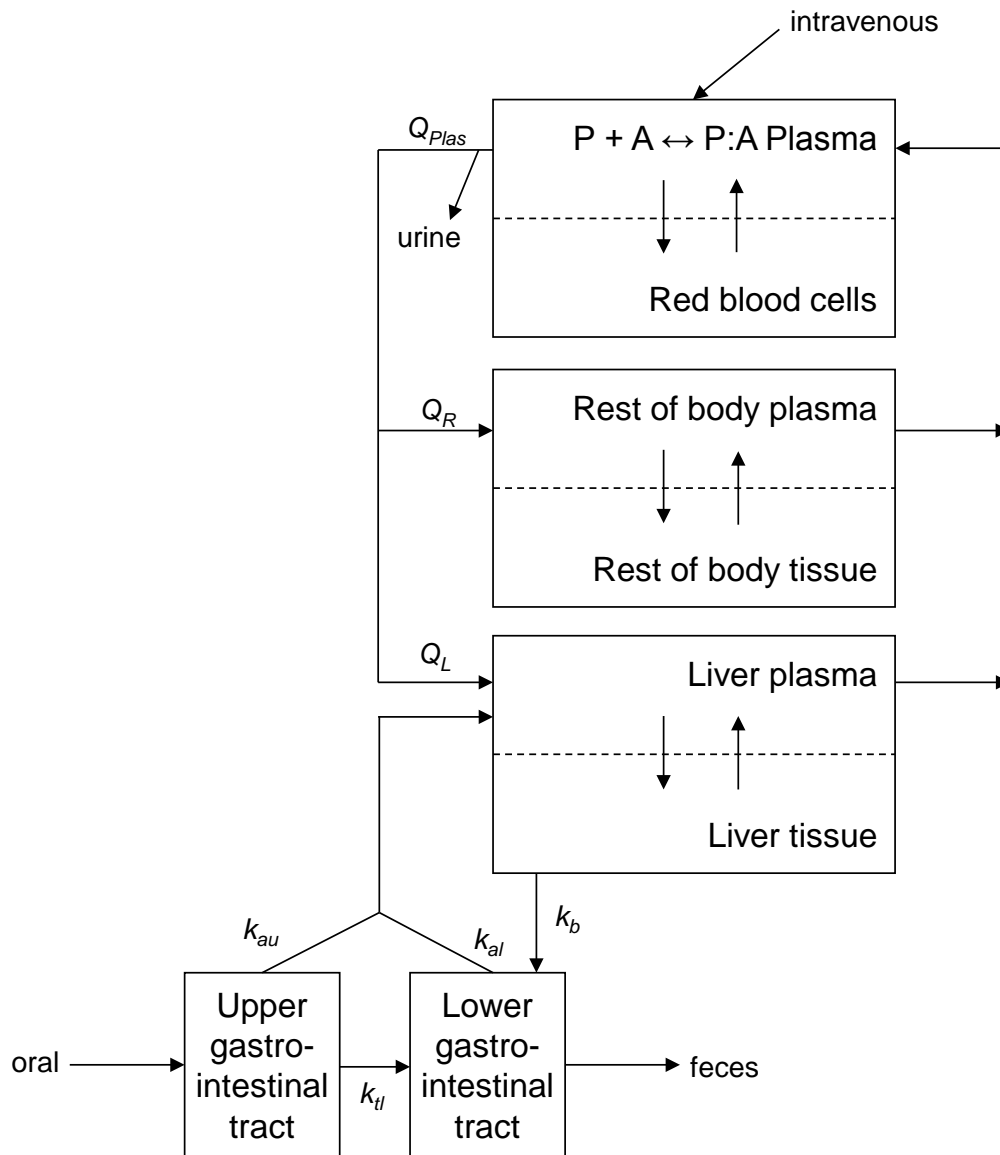
Figure 3-9. Conceptual Representation of a Physiologically Based Pharmacokinetic Model for PFOS Exposure in Rats

k_{al} = rate of absorption from the lower gastrointestinal tract; k_{au} = rate of absorption from the upper gastrointestinal tract; k_b = maximum rate of biliary elimination; k_t = rate of transfer from upper-lower gastrointestinal tract; P:A = PFOS-bound albumin in plasma; PFOS = perfluorooctane sulfonic acid Q_L = plasma flow rate to the liver; Q_{Plas} = plasma flow rate by the heart; Q_R = plasma flow rate to the rest of body

Source: Harris and Barton 2008 (reproduced with permission of Elsevier Ireland Ltd. in the format reuse in a government report via Copyright Clearance Center; Toxicology Letters by European Societies of Toxicology)

3. TOXICOKINETICS, SUSCEPTIBLE POPULATIONS, BIOMARKERS, CHEMICAL INTERACTIONS

other tissues. Binding of PFOA to plasma albumin is assumed to be saturable, with a dissociation constant 10^{-7} M and a maximum capacity 4.1×10^{-4} M. This is implemented by assigning bound PFOA to a subcompartment of plasma in which PFOA enters (binds) or exits (unbinds) at rates governed by binding *on* and *off* rates, respectively, that yield a dissociation constant of 10^{-7} M. Elimination of absorbed chemical occurs by biliary excretion and urinary excretion. Transfer from liver to the lower gastrointestinal tract (representing excretion following biliary transfer) is represented as a first-order process acting on the total amount of PFOS in liver. PFOA is transferred to urine from the free fraction of plasma at a rate governed by a urinary clearance parameter, which is assigned value of 28% of renal plasma flow.

In evaluating performance of the model for simulating PFOS concentrations in a chronic rat feeding study, Harris and Barton (2008) found that the model predicted plasma and liver concentrations measured at 4 and 16 weeks, but over-predicted both at 104 weeks. Performance of the model was improved by having renal clearance increase and the liver/plasma partition coefficient decrease as a function of time (i.e., study duration). These results suggest the possibility that clearance of PFOS may be dependent on age and/or a metric of dose (e.g., cumulative internal dose). This may reflect age- or dose-related changes in kidney function, including tubular reabsorption or secretion of PFOS.

Applications for Dosimetry Extrapolation and Risk Assessment. The model simulates kinetics of PFOS following oral or intravenous dosing in adult rats and includes several features that are different from other PBPK models of perfluoroalkyls. The Harris and Barton (2008) model includes a red cell compartment that allows predictions of whole-blood concentrations. The utility of this feature remains to be determined, since PFOS does not appreciably concentrate in red blood cells and PFOS (and other perfluoroalkyls) is typically monitored in the central compartment with measurements of plasma or serum concentrations. The model assumes that the total concentration of PFOS (not just the free concentration) in plasma is available for distribution to liver and other tissues, whereas other models assume that only the free pool in plasma exchanges with tissues. The practical consequence of this difference may not be significant in terms of the toxicokinetics of PFOS if the tissue/plasma partition coefficients in the various models were estimated based on the relevant perfluoroalkyl pool in plasma. However, without basing distribution kinetics on the free concentration, it is not possible for concentration-dependent free fraction to be modeled. The model assumes time-dependence in the liver uptake and urinary excretion of PFOS, which were needed to improve predictions of plasma and liver concentrations of PFOS during chronic exposures. Other rat models (Loccisano et al. 2012a) have not been similarly evaluated. A mechanistic

3. TOXICOKINETICS, SUSCEPTIBLE POPULATIONS, BIOMARKERS, CHEMICAL INTERACTIONS

understanding of the time-dependent changes in PFOS kinetics will be important for applications of these models for dosimetry extrapolation across exposure durations.

3.1.5.6 Worley and Fisher (2015a, 2015b) Rat Model

Worley and Fisher (2015a, 2015b) expanded the Loccisano et al. (2012a) adult rat model to include simulation of renal proximal tubule apical (tubule-lumen) and basolateral (tubule-plasma) PFOA transport. This configuration allowed the use of data from *in vitro* studies of kinetics of specific transporters thought to be involved in proximal tubular transport of PFOA in the parametrization of the model. The kidney compartment was expanded to include compartments representing the proximal tubule lumen (glomerular filtrate) and proximal tubule cells. In the model, transfer of PFOA to the tubule lumen is governed by the glomerular filtration rate, represented by a clearance parameter (L/hour/kg kidney). PFOA in the tubule lumen can undergo first-order transfer to urine or saturable transport into the tubule cell (K_m , V_{max}). PFOA in the tubule exchanges with PFOA in plasma by three mechanisms: saturable transport from plasma into the cell (K_m , V_{max}), first-order transport from the cell to plasma (kefflux), or bidirectional diffusion between the cell and plasma (kdif). Parameter values (K_m , V_{max}) for apical and basolateral transport of PFOA were derived from *in vitro* estimates for OATP1a1 (apical) and OAT1 and OAT3 (basolateral) (Nakagawa et al. 2008; Weaver et al. 2010; Yamada et al. 2007). These estimates were scaled to kidney proximal tubule cell mass (Hsu et al. 2014) and the mass-scaled estimates of V_{max} were adjusted with relative activity factors, which were calibrated to *in vivo* observations of plasma PFOA elimination kinetics in rats (Kemper 2003). Values for kefflux (proximal tubule cell to kidney plasma) and kdif (diffusion between kidney plasma and the tubule cell) were also calibrated with *in vivo* data (Kemper 2003; Kudo et al. 2007).

Calibration of the relative activity factor for apical and basolateral membrane transport of PFOA to serum observations made in male and female rats resulted in lower values for activity of both transporters in females compared to males. This resulted in the model predicting lower rates of reabsorptive transfer of filtered PFOA to plasma, and higher renal and systemic (plasma) clearance in females compared to males. Because proximal tubule transporters were assumed to be saturable, the model predicts an increase in clearance with increasing PFOA dose, with larger increases in clearance at lower doses in females compared to males. The model simulated the observed dose-dependent increase in serum clearance (decreasing serum $t_{1/2}$) and higher serum clearance of PFOA (lower $t_{1/2}$) in female rats compared to males (Kemper 2003).

3. TOXICOKINETICS, SUSCEPTIBLE POPULATIONS, BIOMARKERS, CHEMICAL INTERACTIONS

3.1.5.7 Worley et al. (2017b) Human Model

Worley et al. (2017b) scaled and calibrated the Worley and Fisher (2015a, 2015b) rat model to simulate PFOA kinetics in humans exposed to PFOA in drinking water. Physiological parameters were allometrically scaled to the human. Tissue-plasma partition coefficients were derived from human autopsy data (kidney, liver) or studies of distribution of PFOA in rats (Fabrega et al. 2014; Kudo et al. 2007; Perez et al. 2013). Parameter values (K_m , V_{max}) for apical and basolateral transport of PFOA were derived from *in vitro* estimates for OAT4 (apical) and OAT1 and OAT3 (basolateral) (Nakagawa et al. 2008; Weaver et al. 2010; Yang et al. 2010; Yamada et al. 2007). These estimates were scaled to kidney proximal tubule cell mass (Hsu et al. 2014) and the mass-scaled estimates of V_{max} were adjusted with relative activity factors. Parameters that control apical and basolateral transfers of PFOA in the proximal tubule and absorption in the gastrointestinal tract were calibrated against data on serum PFOA concentrations measured in people who drank water from a municipal water supply (Worley et al. 2017b). Model parameter values were adjusted to achieve agreement with geometric mean serum PFOA concentrations measured at two times separated by 6 years. The model was evaluated by comparing predicted and observed serum PFOA concentrations in populations exposed to PFOA in drinking water (Bartell et al. 2010; Emmett et al. 2006b; Steenland et al. 2009a, 2009b). A sensitivity analysis of the model identified that following biokinetic parameters that had standardized sensitivity coefficients >0.1 : parameters controlling proximal tubule transport and urinary excretion, plasma-liver partition coefficient, biliary excretion and protein binding. These parameters, along with drinking water consumption, were assigned probability distributions to conduct a Monte Carlo analysis of predicted serum PFOA predictions associated with exposures to PFOA in drinking water. The probabilistic model simulated interindividual variability in serum PFOA concentrations observed in exposed populations (Bartell et al. 2010; Emmett et al. 2006b; Steenland et al. 2009a, 2009b). These results suggest that that biokinetic variability, as well as exposure variability, may contribute to variability in serum PFOA concentrations observed in populations.

3.1.5.8 Fàbrega et al. (2014, 2016) Human Model

Fàbrega et al. (2014, 2016) modified the Loccisano et al. (2011, 2013) human models for PFOA and PFOS with inclusion of brain and lung compartments and removal of the skin compartment. Tissue-plasma partition coefficients were re-estimated using data from human cadavers (Maestri et al. 2006) in place of estimates based on rat data (Loccisano et al. 2011). The major differences in the partition coefficients for PFOA were lower values for liver in humans (1.03) compared to rats (2.20), higher values for fat in humans (0.47) compared to rats (0.04), and inclusion of partition coefficients for brain (0.17)

3. TOXICOKINETICS, SUSCEPTIBLE POPULATIONS, BIOMARKERS, CHEMICAL INTERACTIONS

and lung (1.27). For PFOS, the major differences in the partition coefficients were lower values for liver in humans (2.67) compared to rats (3.72) and higher values for fat in humans (0.33) compared to rats (0.14). Values for parameters that control urinary excretion (T_m and K_m for reabsorptive transport from glomerular filtrate to kidney tissue) were recalibrated based on plasma concentration data (Ericson et al. 2007). Fàbrega et al. (2014) compared predictions to observed concentrations of PFOA and PFOS in cadaver samples (from Tarragona County, Spain) for constant intakes of 0.11 $\mu\text{g}/\text{day}$ for PFOA or 0.13 $\mu\text{g}/\text{day}$ for PFOS. Better agreement with observations was achieved with partition coefficients based on cadaver data. Fàbrega et al. (2016) performed a quantitative uncertainty analysis of predictions of tissue PFOA and PFOS concentrations by assigning lognormal probability distributions to renal transport parameters, the unbound fraction in plasma, and intake. Probability distributions for PFOA and PFOS intakes were based on data from Domingo et al. (2012a, 2012b). Distributions for biokinetic parameters were established to achieve a coefficient of variation of 0.3 (Allen et al. 1996; Brochot et al. 2007; Sweeney et al. 2001). Observations of tissue PFOA and PFOS were within uncertainty bounds on predictions.

3.1.6 Animal-to-Human Extrapolations

Interspecies differences in the toxicokinetics of perfluoroalkyls and possible differences in the mechanisms of toxicity have been found. The elimination rate for PFOA in female rats is approximately 45 times faster than in male rat, 150 times faster than in *Cynomolgus* monkeys, and approximately 5,000–9,000 times faster than in humans (Bartell et al. 2010; Butenhoff et al. 2004c; Kemper 2003; Olsen et al. 2007a). Elimination of PFOS in male rats is approximately 3 times faster than in *Cynomolgus* monkeys and approximately 40 times faster than in humans (Chang et al. 2012; De Silva et al. 2009; Olsen et al. 2007a; Seacat et al. 2002). These large differences in elimination rates imply that similar external PFOA or PFOS dosages (i.e., $\text{mg}/\text{kg}/\text{day}$) in rats, monkeys, or humans would be expected to result in substantially different steady-state internal doses (i.e., body burdens, serum concentrations) of these compounds in each species. In addition, exposure durations required to achieve steady state would be expected to be much longer in humans than in monkeys or rats. Assuming a terminal elimination $t_{1/2}$ of 1,400 days for PFOA in humans (Olsen et al. 2007a), a constant rate of intake for 17 years would be required to achieve 95% of steady state. Steady state (i.e., 95%) would be achieved in approximately 110 days in monkeys ($t_{1/2}=25$ days, Butenhoff et al. 2004c), 30 days in male rats ($t_{1/2}=7$ days; Kemper 2003), and 1 day in female rats ($t_{1/2}=0.2$ days; Kemper 2003). Using an internal dose metric such as serum perfluoroalkyl concentration and PBPK models that can account for these differences in elimination rates can decrease the uncertainty in extrapolating from animals to humans.

3. TOXICOKINETICS, SUSCEPTIBLE POPULATIONS, BIOMARKERS, CHEMICAL INTERACTIONS

Many perfluoroalkyl-induced effects in rats and mice are mediated through the PPAR α and it is generally agreed that humans and nonhuman primates are refractory, or at least less responsive than rodents, to PPAR α -mediated effects (Corton et al. 2014; Klaunig et al. 2003; Maloney and Waxman 1999). While studies in mice have identified specific effects that require PPAR α activation, for example, postnatal viability (Abbott et al. 2007) and some immunological effects (Yang et al. 2002b), other effects such as hepatomegaly and antigen-specific antibody response (DeWitt et al. 2016) were reported to be PPAR α -independent (Yang et al. 2002b). Therefore, further studies are needed to expand the knowledge regarding PPAR α -dependent and -independent effects that would allow selection of an appropriate animal model for perfluoroalkyls toxicity.

3.2 CHILDREN AND OTHER POPULATIONS THAT ARE UNUSUALLY SUSCEPTIBLE

This section discusses potential health effects from exposures during the period from conception to maturity at 18 years of age in humans. Potential effects on offspring resulting from exposures of parental germ cells are considered, as well as any indirect effects on the fetus and neonate resulting from maternal exposure during gestation and lactation. Children may be more or less susceptible than adults to health effects from exposure to hazardous substances and the relationship may change with developmental age.

This section also discusses unusually susceptible populations. A susceptible population may exhibit different or enhanced responses to certain chemicals than most persons exposed to the same level of these chemicals in the environment. Factors involved with increased susceptibility may include genetic makeup, age, health and nutritional status, and exposure to other toxic substances (e.g., cigarette smoke). These parameters can reduce detoxification or excretion or compromise organ function.

Populations at greater exposure risk to unusually high exposure levels to perfluoroalkyls are discussed in Section 5.7, Populations with Potentially High Exposures.

The possible association between serum perfluoroalkyl levels in children and health effects has been examined in participants of the C8 Health Project and in the general population. The studies examined a number of health effects including alterations in serum lipid levels, adverse renal outcomes, neurodevelopmental alterations, and reproductive development. Immunotoxicity has been examined in children in several general population studies. Additionally, a large number of studies have examined the possible association of elevated serum perfluoroalkyl levels and adverse birth outcomes.

3. TOXICOKINETICS, SUSCEPTIBLE POPULATIONS, BIOMARKERS, CHEMICAL INTERACTIONS

Similar to adults, associations between serum PFOA and PFOS and serum cholesterol levels were observed in a study of over 12,000 children (Frisbee et al. 2010); an increased risk of high cholesterol was also observed in children with higher serum PFOA and PFOS levels. A smaller study of children (n=43) living in the Mid-Ohio Valley did not find associations between serum PFOA levels and hematology parameters, total cholesterol and liver enzymes, indices of kidney function, or serum TSH levels (Emmett et al. 2006b). Another study of highly-exposed residents did not find any associations between serum PFOA levels in children aged 6–12 years and IQ, reading and math skills, language, memory, learning, or attention (Stein et al. 2013). Similarly, no association between serum PFOA, PFOS, or PFNA levels in children 5–18 years old and the likelihood of ADHD diagnosis was observed in a study of highly-exposed residents, although the study did find an increased risk associated with higher PFHxS levels (Stein and Savitz 2011). A general population study that utilized the NHANES data found an association between serum PFOA, PFOS, and PFHxS levels and the risk of ADHD diagnosis (as reported by the parent) (Hoffman et al. 2010). Another smaller-scale study found associations between serum PFOS, PFNA, PFDeA, PFHxS, and PFOSA and impulsivity; no association with PFOA was found (Gump et al. 2011). A study of children 8–18 years of age participating in the C8 studies found reduced odds of reaching puberty at higher serum PFOA levels (Lopez-Espinosa et al. 2011); however, the biological significance of the short delay (4–5 months) is not known.

Several studies have evaluated immunotoxicity in children and adolescents. These studies have found impaired antibody responses associated with serum PFOA, PFOS, PFHxS, and PFDeA (Grandjean et al. 2012, 2017; Granum et al. 2013; Mogensen et al. 2015a; Stein et al. 2016a). An increased asthma diagnosis was also associated with serum PFOA levels (Dong et al. 2013; Humblet et al. 2014; Zhu et al. 2016). Marginal evidence was also found for PFOS, PFHxS, PFNA, PFDeA, PFBuS, and PFDaA (Dong et al. 2013; Zhu et al. 2016), although some studies found no associations for these compounds (Humblet et al. 2014; Smit et al. 2015; Stein et al. 2016a).

Hines et al. (2009) showed that *in utero* exposure (GDs 1–17) to low levels of PFOA (0.01–0.3 mg/kg/day) resulted in increases in body weight gain in 10–40-week-old mice; by 18 months of age, the body weights in these mice were similar to controls. Increases in serum insulin and leptin levels were also observed in the mice exposed to 0.01 and 0.1 mg/kg/day. The study also compared body weight and body composition of *in utero* exposed mice (exposed on GDs 1–17) and adult exposed mice (exposed for 17 days starting at 8 weeks of age) and found that *in utero* exposure to 1 mg/kg/day resulted in significantly higher body weight, brown fat weight, and white fat weight; this was not observed in mice

3. TOXICOKINETICS, SUSCEPTIBLE POPULATIONS, BIOMARKERS, CHEMICAL INTERACTIONS

exposed to 5 mg/kg/day. The results of the study suggest that gestational exposure to low doses of PFOA may result in increased susceptibility to PFOA toxicity.

A number of studies of highly exposed residents and the general population have examined the potential associations between serum perfluoroalkyl levels and alterations in birth weight. Decreases in birth weight have been found to be associated with higher PFOA (Fei et al. 2007; Lee et al. 2013; Maisonet et al. 2012; Savitz et al. 2012b) or PFOS levels (Maisonet et al. 2012), but not with lower levels of perfluoroalkyls (Fei et al. 2007; Hamm et al. 2010; Inoue et al. 2004; Kim et al. 2011; Monroy et al. 2008; Washino et al. 2009; Whitworth et al. 2012b). The decreases in birth weight were small and not likely biological relevant. Additionally, no increases in the risk of low birth weight infants were found in highly exposed populations (Darrow et al. 2013; Nolan et al. 2009; Savitz et al. 2012b; Stein et al. 2009). No apparent alterations in the risk of birth defects were found in C8 Health Studies (Darrow et al. 2013; Savitz et al. 2012b; Stein et al. 2009) or in another study of these communities (Nolan et al. 2009).

The developmental toxicity of PFOA and PFOS has been investigated in a number of rat and mouse studies. The observed effects include PFOA- and PFOS-induced increases in prenatal losses and decreases in pup survival, decreases in pup body weight, and neurodevelopmental toxicity (Abbott et al. 2007; Albrecht et al. 2013; Case et al. 2001; Chen et al. 2012b; Era et al. 2009; Fuentes et al. 2006, 2007a, 2007b; Grasty et al. 2003; Hu et al. 2010; Johansson et al. 2008; Lau et al. 2003, 2006; Luebker et al. 2005a, 2005b; Onishchenko et al. 2011; Thibodeaux et al. 2003; White et al. 2007, 2009, 2011; Wolf et al. 2007; Xia et al. 2011; Yahia et al. 2008, 2010). Additionally, delays in mammary gland development were observed in mice exposed to PFOA (Macon et al. 2011; White et al. 2007, 2009, 2011). A limited number of developmental endpoints have been examined in rats and mice exposed to PFDeA, PFHxS, or PFBA (Butenhoff et al. 2009a; Das et al. 2008; Harris and Birnbaum 1989; Hoberman and York 2003; Johansson et al. 2008; Viberg et al. 2013). A more in-depth discussion of the developmental toxicity of perfluoroalkyls in animals is included in Section 2.17.

PFOA and PFOS, as well as other perfluoroalkyl compounds, are valid biomarkers of exposure to these compounds in children, as they are in adults. No relevant studies were located regarding interactions of perfluoroalkyl compounds with other chemicals in children or adults. No information was located regarding pediatric-specific methods for reducing peak absorption following exposure to perfluoroalkyl compounds, reducing body burden, or interfering with the mechanism of action for toxic effects.

3. TOXICOKINETICS, SUSCEPTIBLE POPULATIONS, BIOMARKERS, CHEMICAL INTERACTIONS

No studies examining increased susceptibility to the toxicity of perfluoroalkyls were identified. The available epidemiology data identify several potential targets of toxicity of perfluoroalkyls, and individuals with pre-existing conditions may be unusually susceptible. For example, it appears that exposure to PFOA or PFOS can result in increases in serum lipid levels, particularly cholesterol levels. Thus, an increase in serum cholesterol may result in a greater health impact in individuals with high levels of cholesterol or with other existing cardiovascular risk factors. Similarly, increases in uric levels have been observed in individuals with higher perfluoroalkyl levels; increased uric acid may be associated with an increased risk of high blood pressure and individuals with hypertension may be at greater risk. Additionally, associations have been found between PFOA and PFOS levels and an increased risk of hypertension/pre-eclampsia in pregnant women. The liver has been shown to be a sensitive target in a number of animal species and there is some indication that it is also a target in humans. Therefore, individuals with compromised liver function may represent a susceptible population. Likewise, individuals with a compromised immune system may have an increased risk of perfluoroalkyl-induced immunotoxicity.

3.3 BIOMARKERS OF EXPOSURE AND EFFECT

Biomarkers are broadly defined as indicators signaling events in biologic systems or samples. They have been classified as biomarkers of exposure, biomarkers of effect, and biomarkers of susceptibility (NAS/NRC 1989).

A biomarker of exposure is a xenobiotic substance or its metabolite(s) or the product of an interaction between a xenobiotic agent and some target molecule(s) or cell(s) that is measured within a compartment of an organism (NAS/NRC 1989). The preferred biomarkers of exposure are generally the substance itself, substance-specific metabolites in readily obtainable body fluid(s), or excreta. Biomarkers of exposure to perfluoroalkyls are discussed in Section 3.3.1. The National Report on Human Exposure to Environmental Chemicals provides an ongoing assessment of the exposure of a generalizable sample of the U.S. population to environmental chemicals using biomonitoring (see <http://www.cdc.gov/exposurereport/>). If available, biomonitoring data for perfluoroalkyls from this report are discussed in Section 5.6, General Population Exposure.

Biomarkers of effect are defined as any measurable biochemical, physiologic, or other alteration within an organism that (depending on magnitude) can be recognized as an established or potential health impairment or disease (NAS/NRC 1989). This definition encompasses biochemical or cellular signals of

3. TOXICOKINETICS, SUSCEPTIBLE POPULATIONS, BIOMARKERS, CHEMICAL INTERACTIONS

tissue dysfunction (e.g., increased liver enzyme activity or pathologic changes in female genital epithelial cells), as well as physiologic signs of dysfunction such as increased blood pressure or decreased lung capacity. Note that these markers are not often substance specific. They also may not be directly adverse, but can indicate potential health impairment (e.g., DNA adducts). Biomarkers of effect caused by perfluoroalkyls are discussed in Section 3.3.2.

A biomarker of susceptibility is an indicator of an inherent or acquired limitation of an organism's ability to respond to the challenge of exposure to a specific xenobiotic substance. It can be an intrinsic genetic or other characteristic or a preexisting disease that results in an increase in absorbed dose, a decrease in the biologically effective dose, or a target tissue response. If biomarkers of susceptibility exist, they are discussed in Section 3.2, Children and Other Populations that are Unusually Susceptible.

3.3.1 Biomarkers of Exposure

Measurement of serum or whole-blood perfluoroalkyl concentrations is the standard accepted biomarker of perfluoroalkyl exposure in humans. Perfluoroalkyl compounds have been detected in the serum of workers, residents living near perfluoroalkyl facilities, and the general population. As part of NHANES, CDC has been measuring serum levels of perfluoroalkyls in the U.S. general population since 1999. Of the 14 perfluoroalkyls examined in this toxicological profile, blood concentrations of 7 compounds (PFOA, PFOS, PFDeA, PFHxS, PFNA, Me-PFOSA-AcOH, and PFUA) were detected in enough subjects to allow for estimation of the geometric mean. As compared to the general population, serum PFOA and PFOS levels are much higher in individuals with occupational exposure to these compounds (Olsen et al. 2003a; Sakr et al. 2007a) and PFOA levels are much higher in individuals living near a PFOA manufacturing facility (Emmett et al. 2006a; Hölzer et al. 2008; Steenland et al. 2009a), suggesting that serum levels are a good biomarker of exposure. Due to the long half-life of some perfluoroalkyl compounds, particularly PFOA and PFOS, elevated serum levels may not be indicative of recent exposure. Although elevated serum levels are likely to be indicative of exposure to the parent compound, their presence in blood can also indicate exposure to other perfluoroalkyl compounds. For example, PFOS can be derived from metabolism of Et-PFOSA-AcOH, Me-PFOSA-AcOH, or PFOSA (Olsen et al. 2005; Seacat and Luebker 2000). PFOA can be derived from metabolism of 8-2 fluorotelomer alcohol (Fasano et al. 2006; Henderson and Smith 2007; Kudo et al. 2005; Nabb et al. 2007). Exposure of mice to 8-2 telomer alcohol also generated PFNA as a metabolite (Kudo et al. 2005). Because Et-PFOSA-AcOH and Me-PFOSA-AcOH are metabolized fairly rapidly and have a relatively short serum $t_{1/2}$, their

3. TOXICOKINETICS, SUSCEPTIBLE POPULATIONS, BIOMARKERS, CHEMICAL INTERACTIONS

presence in serum should indicate only recent non-occupational exposure in the general population (Olsen et al. 2005).

Two studies have also evaluated the use of perfluoroalkyl levels in hair as a biomarker of exposure. In rats administered PFOA, PFOS, or PFNA in the drinking water for 90 days, significant correlations between hair perfluoroalkyl levels and serum and tissue (liver, heart, lung, kidney) levels were found, suggesting that hair perfluoroalkyl levels may be a reliable biomarker of exposure (Gao et al. 2015). A study in humans (Alves et al. 2015) has also found detectable levels of PFBA, PFHxA, PFOA, PFBuS, and PFHxS in hair samples, but PFHpA, PFNA, and PFOS were not detected in hair samples. The study did not evaluate the potential relationship between serum perfluoroalkyl levels and hair levels, which does not allow for an assessment of whether it is a viable biomarker of exposure.

3.3.2 Biomarkers of Effect

There are no specific biomarkers of effect caused by perfluoroalkyl compounds.

3.4 INTERACTIONS WITH OTHER CHEMICALS

There are limited data on the interactions of perfluoroalkyls with other chemicals. Particularly absent are studies examining toxicological and toxicokinetic interactions of a perfluoroalkyl compound with other perfluoroalkyl compounds. Olestra decreased the absorption of PFOA from the gastrointestinal tract of mice (Jandacek et al. 2010). No additional information was located regarding interactions among chemicals of this class or between perfluoroalkyl compounds and other chemicals. Both PFOA and PFOS (and many other diverse chemicals) can activate the PPAR α , as well as other PPARs to a lesser extent (Takacs and Abbott 2007; Vanden Heuvel et al. 2006). Therefore, it is not unreasonable to speculate that interactions at the receptor level might occur; however, there are no experimental data to support or rule out this presumption. Given that the PPAR α receptor is much less responsive in humans than it is in rodents, it is unclear if this type of possible interaction would be relevant to humans.

CHAPTER 4. CHEMICAL AND PHYSICAL INFORMATION

4.1 CHEMICAL IDENTITY

Information regarding the chemical identity of perfluoroalkyls is located in Table 4-1. This information includes synonyms, chemical formulas and structures, and identification numbers. The perfluoroalkyls discussed in this profile exist as linear and branched isomers depending upon the method of production (see Chapter 5) and the reported values for the physical-chemical properties are typically reflective of the mixtures rather than a single specific isomer.

4.2 PHYSICAL AND CHEMICAL PROPERTIES

Information regarding the physical and chemical properties of perfluoroalkyls is located in Table 4-2.

Perfluoroalkyl compounds are very stable, owing to the strength of the carbon-fluorine bonds, the presence of the three electron pairs surrounding each fluorine atom, and the shielding of the carbon atoms by the fluorine atoms (3M 1999; Kissa 2001; Schultz et al. 2003). Perfluoroalkyl carboxylates and sulfonates are resistant to direct photolysis and reaction with acids, bases, oxidants, and reductants (3M 2000; EPA 2008a; OECD 2002, 2006a, 2007; Schultz et al. 2003).

APFO was shown to decompose starting at 196°C (Krusic and Roe 2004) and PFOA was shown to decompose rapidly in the presence of crushed borosilicate glass at 307°C (Krusic et al. 2005).

1-H perfluoroheptane and perfluoroheptene are noted degradation products.

Perfluoroalkyl carboxylates and sulfonates consist of a perfluorocarbon tail that is both hydrophobic and oleophobic and a charged end that is hydrophilic (3M 1999; de Vos et al. 2008; Kissa 2001; Schultz et al. 2003). This combination of hydrophobic and oleophobic characteristics makes these substances very useful as surfactants. The ability of these substances to repel oil, fat, and water has resulted in their use in surface protectants (Kissa 2001). Their ability to reduce the surface tension of aqueous systems to <20 mN/m has resulted in their use as wetting agents (Kissa 2001). Neutral or uncharged perfluoroalkyls or very long chain constituents are expected to form separate layers when mixed with hydrocarbons and water. Conversely, charged species, salts, and ionized species at relevant pH (i.e., PFOS, PFOA, PFHpA, PFNA) and short-chain species (i.e., PFBA, PFBS) have relatively good solubility in water and alcohol.

4. CHEMICAL AND PHYSICAL INFORMATION

Table 4-1. Chemical Identity of Perfluoroalkyls

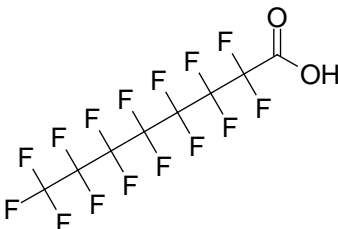
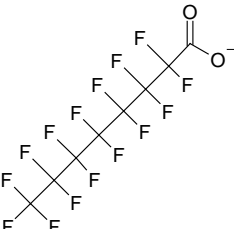
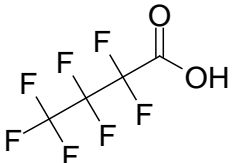
Characteristic	Information		
Chemical name	Perfluorooctanoic acid	Ammonium perfluorooctanoate	Perfluorobutyric acid
Synonym(s)	PFOA; pentadecafluoro-1-octanoic acid; pentadecafluoro-n-octanoic acid; pentadecafluorooctanoic acid; perfluorocaprylic acid; perfluorooctanoic acid; perfluoroheptanecarboxylic acid; octanoic acid, 2,2,3,3,4,4,5,5,6,6,7,7,8,8,8-pentadecafluoro-	APFO; ammonium pentadecafluorooctanoate; octanoic acid, 2,2,3,3,4,4,5,5,6,6,7,7,8,8,8-pentadecafluoro-ammonium salt (1:1)	PFBA; heptafluoro-1-butanoic acid; heptafluorobutanoic acid; heptafluorobutyric acid; perfluorobutanoic acid; perfluorobutyric acid; perfluoropropanecarboxylic acid; 2,2,3,3,4,4,4-heptafluorobutanoic acid
Registered trade name(s)	No data	No data	No data
Chemical formula	$C_8HF_{15}O_2$	$C_8H_4F_{15}NO_2$	$C_4HF_7O_2$
Chemical structure			
CAS Registry Number	335-67-1	3825-26-1	375-22-4

4. CHEMICAL AND PHYSICAL INFORMATION

Table 4-1. Chemical Identity of Perfluoroalkyls

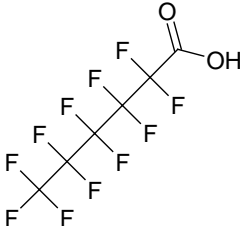
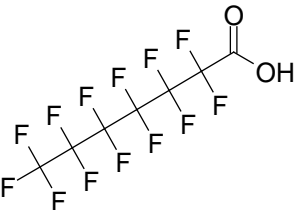
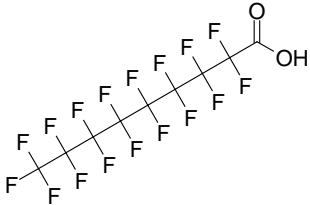
Characteristic	Information		
Chemical name	Perfluorohexanoic acid	Perfluoroheptanoic acid	Perfluorononanoic acid
Synonym(s)	PFHxA; undecafluoro-1-hexanoic acid; hexanoic acid, 2,2,3,3,4,4,5,5,6,6,6-undecafluoro-	PFHpA; perfluoro-n-heptanoic acid; tridecafluoro-1-heptanoic acid; heptanoic acid, 2,2,3,3,4,4,5,5,6,6,7,7,7-tridecafluoro-	PFNA; perfluoro-n-nonanoic acid; perfluorononan-1-oic acid; hepta-decafluoro-nonanoic acid; nonanoic acid, 2,2,3,3,4,4,5,5,6,6,7,7,8,8,9,9,9-heptadecafluoro-
Registered trade name(s)	No data	No data	No data
Chemical formula	C ₆ HF ₁₁ O ₂	C ₇ HF ₁₃ O ₂	C ₉ HF ₁₇ O ₂
Chemical structure			
CAS Registry Number	307-24-4	375-85-9	375-95-1

4. CHEMICAL AND PHYSICAL INFORMATION

Table 4-1. Chemical Identity of Perfluoroalkyls

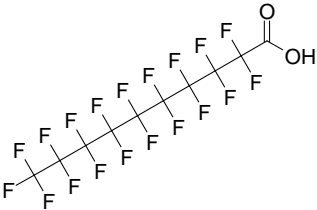
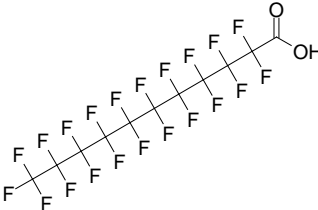
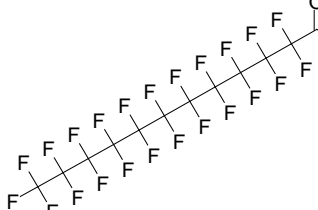
Characteristic	Information		
Chemical name	Perfluorodecanoic acid	Perfluoroundecanoic acid	Perfluorododecanoic acid
Synonym(s)	PFDA; PFDeA; Ndfda; nonadecafluoro-n-decanoic acid; nonadecafluorodecanoic acid; perfluoro-n-decanoic acid; decanoic acid, 2,2,3,3,4,4,5,5,6,6,7,7,8,8,9,9,10,10,10-nonadecafluoro-	PFUA; perfluoro-n-undecanoic acid; hencosafluoroundecanoic acid; 2,2,3,3,4,4,5,5,6,6,7,7,8,8,9,9,10,10,11,11,11-heneicosfluoroundecanoic acid	PFDoA; tricosfluorododecanoic acid; dodecanoic acid, 2,2,3,3,4,4,5,5,6,6,7,7,8,8,9,9,10,10,11,11,12,12,12-tricosfluoro-
Registered trade name(s)	No data	No data	No data
Chemical formula	C ₁₀ HF ₁₉ O ₂	C ₁₁ HF ₂₁ O ₂	C ₁₂ HF ₂₃ O ₂
Chemical structure			
CAS Registry Number	335-76-2	2058-94-8	307-55-1

4. CHEMICAL AND PHYSICAL INFORMATION

Table 4-1. Chemical Identity of Perfluoroalkyls

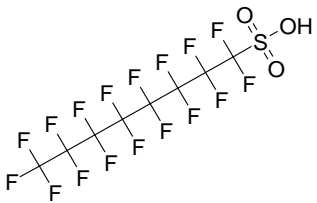
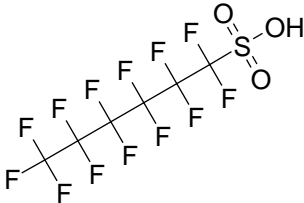
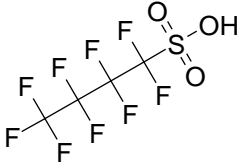
Characteristic	Information		
Chemical name	Perfluorooctane sulfonic acid	Perfluorohexane sulfonic acid	Perfluorobutane sulfonic acid
Synonym(s)	PFOS; 1-perfluorooctanesulfonic acid; heptadecafluoro-1-octanesulfonic acid; heptadecafluorooctan-1-sulphonic acid; perfluorooctane sulfonate; perfluorooctylsulfonic acid; 1-octane-sulfonic acid, 1,1,2,2,3,3,4,4,5,5,6,6,7,7,8,8,8-heptadecafluoro-	PFHxS; perfluorohexane-1-sulphonic acid; 1-hexanesulfonic acid, 1,1,2,2,3,3,4,4,5,5,6,6,6-tridecafluoro-; 1,1,2,2,3,3,4,4,5,5,6,6,6-tridecafluoro-hexane-1-sulfonic	PFBuS; 1-perfluorobutanesulfonic acid; nonafluoro-1-butanesulfonic acid; nonafluorobutanesulfonic acid; pentyl perfluorobutanoate; 1,1,2,2,3,3,4,4,4-nonafluoro-1-butanesulfonic acid; 1,1,2,2,3,3,4,4,4-nonafluorobutane-1-sulphonic acid; 1-butanesulfonic acid, nonafluoro- (6Cl,7Cl,8Cl)
Registered trade name(s)	No data	No data	No data
Chemical formula	$C_8HF_{17}O_3S$	$C_6HF_{13}O_3S$	$C_4HF_9O_3S$
Chemical structure			
CAS Registry Number	1763-23-1	355-46-4	375-73-5

4. CHEMICAL AND PHYSICAL INFORMATION

Table 4-1. Chemical Identity of Perfluoroalkyls

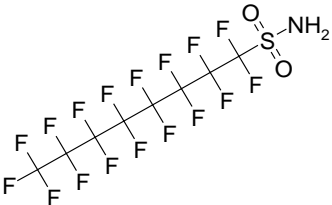
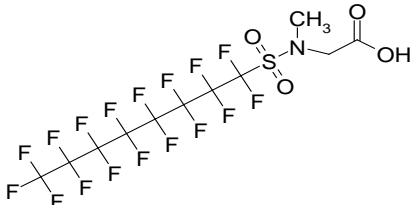
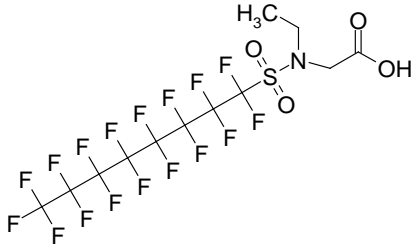
Characteristic	Information		
Chemical name	Perflurorooctanesulfonamide	2-(N-methyl-perfluorooctane sulfonamide) acetic acid	2-(N-ethyl-perfluorooctane sulfonamide) acetic acid
Synonym(s)	PFOSA; perfluorooctylsulfonamide; perfluorooctanesulfonic acid amide; heptadecafluorooctanesulphonamide; 1-octanesulfonamide, 1,1,2,2,3,3,4,4,5,5,6,6,7,7,8,8-heptadecafluoro-	Me-PFOSA-AcOH	Et-PFOSA-AcOH
Registered trade name(s)	No data	No data	No data
Chemical formula	$C_8H_2F_{17}NO_2S$	$C_{11}H_6F_{17}NO_4S$	$C_{12}H_8F_{17}NO_4S$
Chemical structure			
CAS Registry Number	754-91-6	2355-31-9	2991-50-6

CAS = Chemical Abstracts Services

Sources: Calafat et al. 2007a, 2007b; CAS 2008; ChemIDplus 2008, 2017; RTECS 2008

4. CHEMICAL AND PHYSICAL INFORMATION

Table 4-2. Physical and Chemical Properties of Perfluoroalkyls

Property	PFOA	APFO	PFBA	PFHxA
Molecular weight	414.069 ^a	431.1 ^b	214.039 ^a	314.06 ^c
Color	No data	No data	No data	No data
Physical state	Solid ^d	Solid ^b	Liquid ^a	No data
Melting point	54.3°C ^a	Decomposition starts above 105°C ^b	-17.5°C ^a	No data
Boiling point	188°C ^a	No data	121°C ^a	168°C at 742 mm Hg ^e
Density at 20°C	1.8 g/cm ^{3f}	No data	1.651 g/cm ^{3a}	1.789 ^e
Odor	No data	No data	No data	No data
Odor threshold:				
Water	No data	No data	No data	No data
Air	No data	No data	No data	No data
Solubility:				
Water	9.5x10 ³ mg/L at 25°C ^g	>500 g/L ^b	2.14x10 ⁵ mg/L at 25°C ^h	15,700 mg/L ⁱ
Organic solvents	No data	No data	Soluble in ethanol and toluene; insoluble in petroleum ether ^a	No data
Partition coefficients:				
Log K _{ow}	Not applicable ^j	No data	Not applicable ^j	Not applicable ^j
K _{oc}	17–230 ^k	No data	No data	No data
pKa	3.8 ^l	No data	0.08 (estimated) ^m	-0.16 ⁱ
Vapor pressure	0.017 mm Hg at 20°C (extrapolated); 0.962 mm Hg at 59.25°C (measured) ⁿ	0.0081 Pa at 20°C ^b	44 mm Hg at 56°C ^g	No data
Henry's law constant	0.362 Pa·m ³ /mol ^h	No data	1.24Pa·m ³ /mol ^h	No data
Autoignition temperature	Not applicable ^o	No data	Not applicable ^o	Not applicable ^o
Flashpoint	Not applicable ^o	No data	Not applicable ^o	Not applicable ^o
Flammability limits	Not applicable ^o	No data	Not applicable ^o	Not applicable ^o
Conversion factors	1 ppm=17.21 mg/m ³ ; 1 mg/m ³ =0.058 ppm ^p	1 ppm=17.63 mg/m ³ ; 1 mg/m ³ =0.06 ppm ^p	1 ppm=8.90 mg/m ³ ; 1 mg/m ³ =0.11 ppm ^p	1 ppm=12.84 mg/m ³ ; 1 mg/m ³ =0.08 ppm ^p
Explosive limits	Not applicable ^o	Not applicable ^o	Not applicable ^o	Not applicable ^o

4. CHEMICAL AND PHYSICAL INFORMATION

Table 4-2. Physical and Chemical Properties of Perfluoroalkyls

Property	PFHpA	PFNA	PFDeA	PFUA
Molecular weight	364.06 ^e	464.08 ^c	514.084 ^a	564.085 ^d
Color	No data	No data	No data	No data
Physical state	No data	No data	No data	No data
Melting point	24–30°C ^f	No data	No data	97.9–100.3°C ^f
Boiling point	175°C at 742 mm Hg ^g	No data	219°C	No data
Density at 20°C	No data	No data	No data	No data
Odor	No data	No data	No data	No data
Odor threshold:				
Water	No data	No data	No data	No data
Air	No data	No data	No data	No data
Solubility:				
Water	4.37x10 ⁵ mg/L at 25°C ^h	No data	No data	No data
Organic solvents	No data	No data	No data	No data
Partition coefficients:				
Log K _{ow}	Not applicable ⁱ	Not applicable ⁱ	Not applicable ⁱ	Not applicable ⁱ
K _{oc}	No data	No data	No data	No data
pKa	-0.15 (estimated) ^m	-0.17 (estimated) ^m	-0.17 (estimated) ^m	-0.17 (estimated) ^m
Vapor pressure	4.6 mm Hg at 25 °C ^h	4.83x10 ⁻³ mm Hg at 20°C (extrapolated); 8.4 mm Hg at 99.63°C (measured) ⁿ	7.62x10 ⁻⁴ mm Hg at 20°C (extrapolated); 23.5 mm Hg at 129.56°C (measured) ^s	3.44x10 ⁻⁴ mm Hg at 20°C (extrapolated); 4.62 mm Hg at 112.04°C (measured) ^s
Henry's law constant at 25°C	0.573 Pa·m ³ /mol ^h	No data	No data	No data
Autoignition temperature	Not applicable ^o	Not applicable ^o	Not applicable ^o	Not applicable ^o
Flashpoint	Not applicable ^o	Not applicable ^o	Not applicable ^o	Not applicable ^o
Flammability limits	Not applicable ^o	Not applicable ^o	Not applicable ^o	Not applicable ^o
Conversion factors	1 ppm=15.14 mg/m ³ ; 1 mg/m ³ =0.07 ppm ^p	1 ppm=19.29 mg/m ³ ; 1 mg/m ³ =0.05 ppm ^p	1 ppm=21.37 mg/m ³ ; 1 mg/m ³ =0.05 ppm ^p	1 ppm=23.45 mg/m ³ ; 1 mg/m ³ =0.04 ppm ^p
Explosive limits	Not applicable ^o	Not applicable ^o	Not applicable ^o	Not applicable ^o

4. CHEMICAL AND PHYSICAL INFORMATION

Table 4-2. Physical and Chemical Properties of Perfluoroalkyls

Property	PFD _o A	PFOS	PFH _x S	PFBuS
Molecular weight	614.1 ^c	500.03 ^c	400.12 ^c	300.1 ^c
Color	No data	No data	No data	No data
Physical state	No data	No data	No data	No data
Melting point	No data	≥400°C (potassium salt) ^s	No data	No data
Boiling point	No data	No data	No data	No data
Density at 20°C	No data	No data	No data	No data
Odor	No data	No data	No data	No data
Odor threshold:				
Water	No data	No data	No data	No data
Air	No data	No data	No data	No data
Solubility:				
Water	No data	570 mg/L (potassium salt in pure water) ^s	No data	No data
Organic solvents	No data	No data	No data	No data
Partition coefficients:				
Log K _{ow}	Not applicable ⁱ	Not applicable ⁱ	Not applicable ⁱ	Not applicable ⁱ
K _{oc}	No data	No data	No data	No data
pKa	-0.17 (estimated) ^m	0.14 (estimated) ^m	0.14 (estimated) ^m	0.14 (estimated) ^m
Vapor pressure	5.11x10 ⁻⁶⁰ mm Hg at 20°C (extrapolated) ^s	2.48x10 ⁻⁶ mm Hg at 20°C (potassium salt) ^d	No data	No data
Henry's law constant at 25°C	No data	No data	No data	No data
Autoignition temperature	Not applicable ^o	Not applicable ^o	Not applicable ^o	Not applicable ^o
Flashpoint	Not applicable ^o	Not applicable ^o	Not applicable ^o	Not applicable ^o
Flammability limits	Not applicable ^o	Not applicable ^o	Not applicable ^o	Not applicable ^o
Conversion factors	1 ppm=25.53 mg/m ³ ; 1 mg/m ³ =0.04 ppm ^p	1 ppm=20.79 mg/m ³ ; 1 mg/m ³ =0.05 ppm ^p	1 ppm=16.63 mg/m ³ ; 1 mg/m ³ =0.06 ppm ^p	1 ppm=12.48 mg/m ³ ; 1 mg/m ³ =0.08 ppm ^p
Explosive limits	Not applicable ^o	Not applicable ^o	Not applicable ^o	Not applicable ^o

4. CHEMICAL AND PHYSICAL INFORMATION

Table 4-2. Physical and Chemical Properties of Perfluoroalkyls

Property	PFOSA	Me-PFOSA-AcOH	Et-PFOSA-AcOH
Molecular weight	499.15 ^e	571.21 (from structure)	585.24 ^e
Color	No data	No data	No data
Physical state	No data	No data	No data
Melting point	No data	No data	No data
Boiling point	No data	No data	No data
Density at 20°C	No data	No data	No data
Odor	No data	No data	No data
Odor threshold:			
Water	No data	No data	No data
Air	No data	No data	No data
Solubility:			
Water	No data	No data	No data
Organic solvents	No data	No data	No data
Partition coefficients:			
Log K _{ow}	Not applicable ⁱ	Not applicable ^j	Not applicable ⁱ
K _{oc}	No data	No data	No data
pKa	6.24 (estimated) ^m	3.92 (estimated) ^m	3.92 (estimated) ^m
Vapor pressure	No data	No data	No data
Henry's law constant	No data	No data	No data
Autoignition temperature	Not applicable ^o	Not applicable ^o	Not applicable ^o
Flashpoint	Not applicable ^o	Not applicable ^o	Not applicable ^o
Flammability limits	Not applicable ^o	Not applicable ^o	Not applicable ^o

4. CHEMICAL AND PHYSICAL INFORMATION

Table 4-2. Physical and Chemical Properties of Perfluoroalkyls

Property	PFOSA	Me-PFOSA-AcOH	Et-PFOSA-AcOH
Conversion factors	1 ppm=20.75 mg/m ³ ; 1 mg/m ³ =0.05 ppm ^p	1 ppm=23.75 mg/m ³ ; 1 mg/m ³ =0.04 ppm ^p	1 ppm=24.33 mg/m ³ ; 1 mg/m ³ =0.04 ppm ^p
Explosive limits	Not applicable ^o	Not applicable ^o	Not applicable ^o

^aLide 2005.^bEPA 2014.^cEPA 2008c.^d3M 2008c.^eSavu 1994a.^fKroschwitz and Howe-Grant 1994.^gKauck and Diesslin 1951.^hKwan 2001.ⁱZhao et al. 2014.^jThe log K_{ow} is not measureable since these substances are expected to form multiple layers in an octanol-water mixture (3M 1999, 2008c; EPA 2005a).^kPrevedouros et al. 2006.^lBurns et al. 2008.^mSPARC 2008.ⁿKaiser et al. 2005.^oPerfluorocarboxylates and perfluorosulfonates are nonflammable (3M 1999, Kissa 2001, OECD 2007). However, they readily degrade via incineration (Krusic and Roe 2004; Krusic et al. 2005; Yamada et al. 2005).^pCalculated using molecular weight.^qChemID Plus 2008.^rKunleda and Shinoda 1976.^s3M 2000.

Et-PFOSA-AcOH = 2-(N-ethyl-perfluorooctane sulfonamide) acetic acid; Me-PFOSA-AcOH = 2-(N-methyl-perfluorooctane sulfonamide) acetic acid; PFBA = perfluorobutyric acid; PFBuS = perfluorobutane sulfonic acid; PFDeA = perfluorodecanoic acid; PFDoA = perfluorododecanoic acid; PFHpA = perfluoroheptanoic acid; PFHxA = perfluorohexanoic acid; PFHxS = perfluorohexane sulfonic acid; PFNA = perfluorononanoic acid; PFOA = perfluorooctanoic acid; PFOS = perfluorooctane sulfonic acid; PFOSA = perfluorooctane sulfonamide; PFUA = perfluoroundecanoic acid

4. CHEMICAL AND PHYSICAL INFORMATION

Both the potential to form separate layers when mixed with hydrocarbons and water and the propensity for charged or ionized perfluoroalkyls to concentrate at interfaces make the measurement of the n-octanol water partition coefficient impractical (3M 1999; EPA 2005a).

With the exception of PFOSA, estimated pKa values for the perfluoroalkyls listed in Table 4-2 range from -0.17 to 3.92 (SPARC 2008). This pKa range indicates that these substances will exist in anion form when in contact with water at environmental and physiologically relevant pHs. An estimated pKa of 6.24 indicates that PFOSA will exist as both the anion and the neutral species (SPARC 2008).

Perfluoroalkyl salts, such as APFO, will form the corresponding anions when dissolved in water.

Prevedouros et al. (2006) reported a Krafft point of 22°C and critical micelle concentration of 3.7×10^3 mg/L for the perfluorooctanoate anion (PFO). At temperatures above the Krafft point, the solubility of PFO is expected to increase abruptly due to the formation of micelles.

Vapor pressures at 25°C were extrapolated for PFOA, PFNA, PFDeA, PFUA, and PFDoA using Antoine coefficients. Experimental vapor pressures were as follows: 0.962–724 mm Hg (59.25–190.80°C) for PFOA; 8.40–750 mm Hg (99.63–203.12°C) for PFNA; 23.5–750 mm Hg (129.56–218.88°C) for PFDeA; 4.62–750 mm Hg (112.04–237.65°C) for PFUA; and 6.42–750 mm Hg (127.58–247.36°C) for PFDoA (Kaiser et al. 2005).

CHAPTER 5. POTENTIAL FOR HUMAN EXPOSURE

5.1 OVERVIEW

Perfluoroalkyls has been identified in at least 4 of the 1,854 hazardous waste sites that have been proposed for inclusion on the EPA National Priorities List (NPL) (ATSDR 2017). However, the number of sites in which substance perfluoroalkyls has been evaluated is not known. The number of sites in each state is shown in Figure 5-1. Of these sites, 4 are located within the United States.

Figure 5-1. Number of NPL Sites with Perfluoroalkyls Contamination

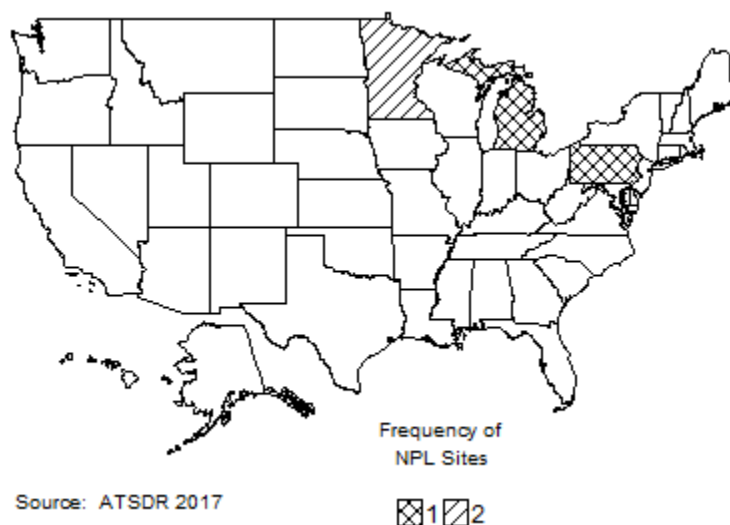

- The general population is exposed to the perfluoroalkyls through food and water ingestion, dust ingestion, inhalation exposure, and hand-to-mouth transfer of materials containing these substances.
- PFOA, PFOS, and their precursor substances are no longer produced or used in the United States or most other industrialized nations; however, these substances are persistent in the environment and exposure near highly contaminated sites may continue to occur.
- Serum levels of PFOA and PFOS in the general population of the United States have declined dramatically since 2000.

Perfluoroalkyls have been released to air, water, and soil in and around fluorochemical facilities located within the United States (3M 2007b, 2008a, 2008b; Barton et al. 2007; Davis et al. 2007; DuPont 2008; EPA 2008a). Since the early 2000s, companies in the fluorochemical industry have been working in concert with the EPA to phase out the production and use of long-chain perfluoroalkyl compounds and their precursors (3M 2008a; DuPont 2008; EPA 2007a, 2008a, 2016a). Perfluorocarboxylic acids

5. POTENTIAL FOR HUMAN EXPOSURE

containing seven or more perfluorinated carbon groups and perfluoroalkyl sulfonic acids containing six or more perfluorinated carbon units are considered long-chain substances. Perfluorinated carboxylic acids and sulfonic acids containing less than seven and six perfluorinated carbons, respectively, are considered short-chain substances. The short-chain substances are not as bioaccumulative as the longer-chain substances such as PFOA and PFOS. PFOA, PFOA precursors, and higher homologues have been phased out by the eight corporations in the perfluorotelomer/fluorotelomer industry (Arkema, Asahi, BASF [successor to Ciba], Clariant, Daikin, 3M/Dyneon, DuPont, and Solvay Solexis) as part of the EPA's PFOA Stewardship Program (DuPont 2008; EPA 2008a, 2016a). Industrial releases of these compounds in the United States have declined or been totally eliminated based on company reports submitted to EPA (EPA 2008a, 2016a). Although the United States and most industrialized nations have stopped producing PFOA and PFOS, China remains a major producer and user of both substances, and its production has increased as production in the rest of the world has declined (HAES 2017; Li et al. 2015; Lim et al. 2011).

Perfluoroalkyl carboxylic acids and sulfonic acids are expected to dissociate in the environment based on their low pKa values (Kissa 2001; SPARC 2008), and anions will not volatilize from water or soil surfaces (Prevedouros et al. 2006). The unique surfactant properties of these substances may prevent total dissociation of perfluoroalkyls in water (EPA 2005a; Kissa 2001; Prevedouros et al. 2006); therefore, some volatilization of perfluoroalkyls may occur since the neutral forms of these substances are considered to be volatile (Barton et al. 2007; EPA 2005a; Kim and Kannan 2007). Perfluoroalkyls have been detected in air both in the vapor phase and as adsorbed to particulates (Kim and Kannan 2007). Perfluoroalkyls are very stable compounds and are resistant to biodegradation, direct photolysis, atmospheric photooxidation, and hydrolysis (3M 2000; EPA 2008a; OECD 2002, 2007; Schultz et al. 2003). Perfluoroalkyls released to the atmosphere are expected to adsorb to particles and settle to the ground through wet or dry deposition (Barton et al. 2007; Hurley et al. 2004; Prevedouros et al. 2006). The chemical stability of perfluoroalkyls and the low volatility of these substances in ionic form indicate that perfluoroalkyls will be persistent in water and soil (3M 2000; Prevedouros et al. 2006). Soil adsorption coefficient data as well as monitoring studies suggest that perfluoroalkyls such as PFOA are mobile in soil and can leach into groundwater (Davis et al. 2007; Prevedouros et al. 2006).

Perfluoroalkyls have been detected in environmental media and biota of the Arctic region and in other remote locations such as open ocean waters (Barber et al. 2007; Prevedouros et al. 2006; Wei et al. 2007a; Yamashita et al. 2005, 2008). Proposed source pathways include long-range atmospheric transport of precursor compounds followed by photooxidation to form perfluoroalkyls, direct long-range transport of

5. POTENTIAL FOR HUMAN EXPOSURE

perfluoroalkyls via oceanic currents, and transport of perfluoroalkyls in the form of marine aerosols (Armitage et al. 2006; Barber et al. 2007; Prevedouros et al. 2006; Wania 2007). Direct transport of perfluoroalkyls in the atmosphere has also been proposed as a source pathway since these substances have been detected in the vapor phase in outdoor air samples (CEMN 2008; Prevedouros et al. 2006). The actual source of perfluoroalkyls in remote locations is likely to be a combination of these pathways.

The highest concentrations of PFOA and PFOS were in apex predators, such as polar bears, which indicates that these substances biomagnify in food webs (de Vos et al. 2008; Houde et al. 2006b; Kannan et al. 2005; Kelly et al. 2007; Smithwick et al. 2005a, 2005b, 2006). The bioaccumulation potential of perfluoroalkyls is reported to increase with increasing chain length (de Vos et al. 2008; Furdui et al. 2007; Martin et al. 2004b). In living organisms, perfluoroalkyls bind to protein albumin in blood, liver, and eggs and do not accumulate in fat tissue (de Vos et al. 2008; Kissa 2001).

The levels of PFOA and PFOS in serum samples of U.S. residents have decreased appreciably since the phase out of these substances in the United States. The geometric mean serum levels of PFOS have declined over 80% from NHANES survey years 1999–2000 (30.4 ng/mL) to 2013–2014 (4.99 ng/mL) and the geometric mean serum levels of PFOA have declined almost 70% over the same temporal period, decreasing from 5.2 ng/mL in years 1999–2000 to 1.94 ng/mL for 2013–2014 (CDC 2018).

Mean concentrations of PFHpA, PFNA, PFDeA, PFUA, PFDoA, PFBuS, PFBA, PFOSA, Me-PFOSA-AcOH, and Et-PFOSA-AcOH are generally <1 ng/mL (Calafat et al. 2006b, 2007a, 2007b; CDC 2015; De Silva and Mabury 2006; Kuklenyik et al. 2004; Olsen et al. 2003a, 2003b, 2004c, 2005, 2007a). Major PFOS exposure pathways proposed for the general population include food and water ingestion, dust ingestion, and hand-to-mouth transfer from mill- or home-treated carpets (Trudel et al. 2008). For PFOA, the major exposure pathways are proposed to be oral exposure resulting from general food and water ingestion, inhalation from impregnated clothes, and dust ingestion. While migration of residual PFOA in paper packaging and wrapping into food is also a potential route of exposure (Trudel et al. 2008), polyfluoroalkyl phosphoric acids in food packaging can also be metabolized in the body to PFOA (D'eon and Mabury 2007; D'eon et al. 2009). Polyfluoroalkyl phosphoric acids are fluorinated surfactant substances used to greaseproof food-containing paper products. Biotransformation of the 8:2 polyfluoroalkyl phosphoric acid and the 8:2 fluorotelomer alcohol into PFOA has been demonstrated (D'eon et al. 2009). Based on these proposed exposure pathways, Trudel et al. (2008) estimated that adult uptake doses for high-exposure scenarios were approximately 30 and 47 ng/kg body weight/day for PFOS and PFOA, respectively. The estimated dosage for children under the age of 12 under a high-exposure

5. POTENTIAL FOR HUMAN EXPOSURE

scenario were estimated to be 101–219 and 65.2–128 ng/kg body weight/day for PFOS and PFOA, respectively (Trudel et al. 2008). Estimated daily doses for the general population were also estimated by Vestergren et al. (2008) to range from 3.9 to 520 ng/kg body weight/day for PFOS and from 0.3 to 150 ng/kg body weight/day for PFOA. Infants and toddlers had the highest estimated dosages due to greater hand-to-mouth contact with treated carpeting, mouthing activities of clothes, and greater dust ingestion. While conversion of precursor compounds to PFOA and PFOS was generally considered as a minor contribution to the total exposure, under certain scenarios, it was estimated that up to 80% of the intake could be attributable to exposure to precursor substances followed by subsequent metabolism to PFOS or PFOA.

Perfluoroalkyls have been detected in human breast milk and umbilical cord blood. The reported maximum concentrations of PFOS and PFOA measured in human breast milk samples were 0.360–0.685 and 0.210–0.609 ng/mL, respectively (Kärman et al. 2007; Llorca et al. 2010; So et al. 2006b; Völkel et al. 2008). Maximum concentrations of other perfluoroalkyl compounds were <0.18 ng/mL (Kärman et al. 2007). PFOS and PFOA have been detected in most umbilical cord blood samples with reported concentrations of 4.9–11.0 and 1.6–3.7 ng/mL, respectively (Apelberg et al. 2007a, 2007b; Fei et al. 2007; Inoue et al. 2004; Midasch et al. 2007). Other perfluoroalkyls have been detected less frequently, with maximum concentrations of <2.6 ng/mL.

Individuals who perform jobs that require frequent contact with perfluoroalkyl-containing products, such as individuals who install and treat carpets or firefighters, are expected to have occupational exposure to these substances. Individuals who work at fluorochemical facilities generally have had higher perfluoroalkyl serum levels than the general population based on exposures in the work environment (3M 2007b, 2008b, 2008c; Barton et al. 2006; Davis et al. 2007). Studies of individuals living near fluorochemical facilities indicate that drinking water is the major exposure pathway (Emmett et al. 2006a; Hölzer et al. 2008; Wilhelm et al. 2009). 3M conducted an exposure assessment to estimate the cumulative exposure to PFOA due to activities at the Decatur, Alabama facility. On-site exposure to groundskeepers, maintenance workers, construction workers, and on-site trespassers were considered. Off-site exposures to anglers, boaters, and residential individuals were also estimated. Various plausible exposure scenarios were considered, and the highest PFOA exposure doses by receptor and pathway occurred for local residents from groundwater followed by residents consuming drinking water from the West Morgan/East Lawrence (WM/EL) public drinking water supply (3M 2008c).

5. POTENTIAL FOR HUMAN EXPOSURE

5.2 PRODUCTION, IMPORT/EXPORT, USE, AND DISPOSAL**5.2.1 Production**

Perfluoroalkyls been manufactured industrially by electrochemical fluorination (ECF), fluorotelomer iodide oxidation, fluorotelomer olefin oxidation, and fluorotelomer iodide carboxylation (Prevedouros et al. 2006; Schultz et al. 2003). During the ECF process, an organic acyl or sulfonyl fluoride backbone structure is dissolved in a solution of aqueous hydrogen fluoride (Savu 1994b; Siegemund et al. 2005). A direct electrical current is then passed through the solution, which replaces all of the hydrogens on the molecule with fluorines. Perfluoroacyl fluorides produced by ECF are hydrolyzed to form the perfluorocarboxylic acid, which is then separated via distillation. This method was used extensively by 3M in the production of perfluoroalkylsulfonates such as PFOS (3M 1999; Hekster et al. 2003; Schultz et al. 2003).

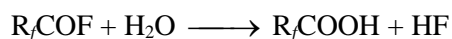

Perfluoroalkanesulfonyl fluorides produced by ECF are hydrolyzed under alkaline conditions to form the corresponding salt (Savu 1994b; Siegemund et al. 2005). Acidification followed by distillation yields the anhydrous perfluoroalkanesulfonic acid.

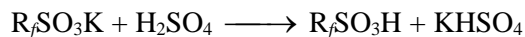
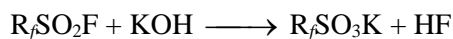
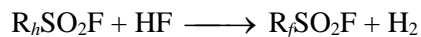

Perfluorosulfonamido compounds, such as PFOSA, can be formed by reacting the perfluoroalkanesulfonyl fluoride with a primary or secondary amine (3M 1999; Hekster et al. 2003; Siegemund et al. 2005).

The fluorotelomer iodide oxidation process was developed by DuPont and has served as the basis for their fluoropolymer production chemistry (Buck et al. 2011; Hekster et al. 2003; Savu 1994a; Siegemund et al. 2005). It begins with the preparation of pentafluoroiodoethane from tetrafluoroethene. Tetrafluoroethene is then added to this product at a molar ratio that gives a product of desired chain length. Finally, the

5. POTENTIAL FOR HUMAN EXPOSURE

product is oxidized to form the carboxylic acid. The process produces linear perfluorocarboxylic acids of even carbon numbers as illustrated below.

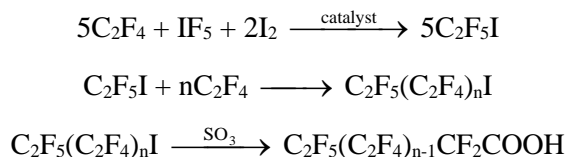

Fluorotelomer alcohols are created similarly, but the perfluoroalkyl iodide (telomer A) is reacted with ethylene to create $\text{F}(\text{CF}_2)_n\text{CH}_2\text{CH}_2\text{I}$ (telomer B), which is converted to the alcohol. The ECF process resulted in a mixture of linear and branched isomers, whereas the telomerization processes yielded predominantly linear products. It has been reported that the 3M ECF process resulted in approximately 70% linear and 30% branched isomers for PFOS and 78% linear and 22% branched isomers for PFOA (Benskin et al. 2009).

No information is available in the TRI database on facilities that manufacture, process, or otherwise use perfluoroalkyls because this class of substances is not required to be reported under Section 313 of the Emergency Planning and Community Right-to-Know Act (Title III of the Superfund Amendments and Reauthorization Act of 1986) (EPA 2005a, 2016g). The Chemical Data Reporting (CDR) rule, under the Toxic Substances Control Act (TSCA), requires manufacturers (including importers) to provide EPA with information on the production and use of chemicals in commerce in large quantities. Information on perfluoroalkyls can be found at (<https://www.epa.gov/chemical-data-reporting/basic-information-chemical-data-reporting#what>).

Perfluoroalkyls have been manufactured for their direct use in commercial products as well as for their use in industrial process streams. Two important chemicals that have resulted from manufacturing involving perfluoroalkyls, namely PFOS and PFOA, are of worldwide interest given their detection in multiple media in the environment. However, these substances and related long-chain perfluoroalkyl compounds have been essentially phased out as a joint effort by EPA and industry (Lindstrom et al. 2011). The timeline for history of perfluorinated compound production, use, and phase out is presented in Figure 5-2. Given their unique properties, certain narrow exceptions exist for specific applications. Additionally, many of the substances that were used in the production of stain resistant or anti-sticking products that could break down into PFOA and PFOS have also been replaced.

5. POTENTIAL FOR HUMAN EXPOSURE

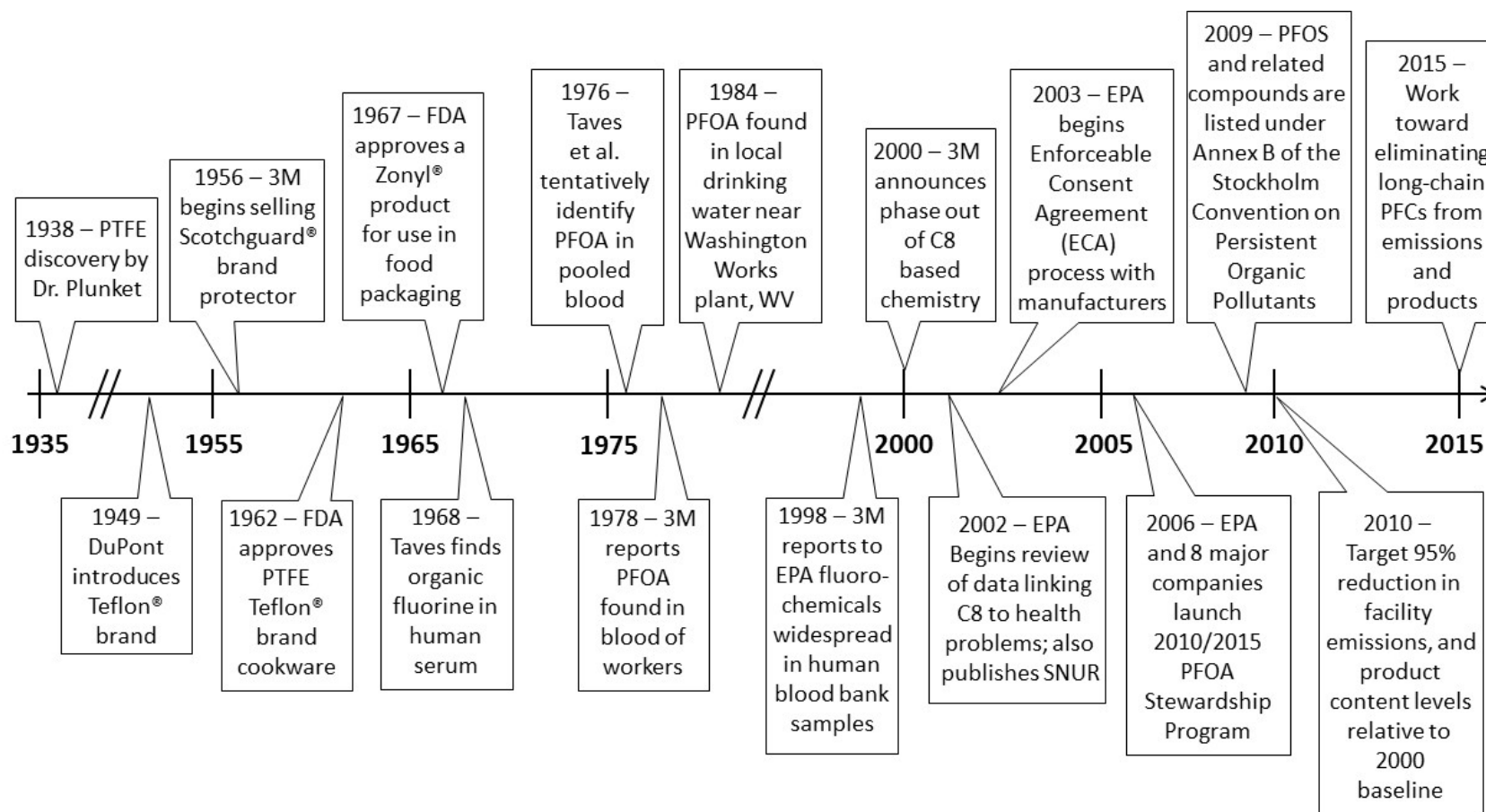
Figure 5-2. Timeline of Important Events in the History of Polyfluorinated Compounds

EPA = U.S. Environmental Protection Agency; PFC = perfluorinated compound; PFOA = perfluorooctanoic acid; PTFE = polytetrafluoroethylene; SNUR = significant new use rule; WV = West Virginia

Source: Reprinted (adapted) with permission from Lindstrom et al. 2011 (Environ Sci Technol 45:7954-7961). Copyright 2011 American Chemical Society.

5. POTENTIAL FOR HUMAN EXPOSURE

The 3M Company was the principal worldwide manufacturer of PFOS and related chemicals. As a result of its phase-out decision in May 2000, 3M no longer manufactures perfluorooctanyl compounds (PFOA and PFOS). The company ceased manufacturing and using the vast majority of these compounds within approximately 2 years of the phase-out announcement, and ceased all manufacturing and the last significant use of this chemistry by the end of 2008 (3M 2008a; EPA 2007a). In 2000, EPA finalized the significant new use rule (SNUR) for 88 perfluoroalkyl sulfonate compounds, which requires manufacturers to notify EPA 90 days prior to commencing manufacture or import of these substances for a significant new use to allow time for evaluation (EPA 2002, 2007a, 2008a). The purpose of this rule was to limit future manufacturing and importation of these substances. According to EPA, the rule allowed for the continuation of a few limited, highly technical uses for which no alternatives are available, and which are characterized by very low volume, low exposure, and low releases. The SNUR was amended in 2007 to include 183 additional perfluoroalkyl sulfonate compounds (EPA 2007a, 2008a).

Included on the current list are PFOS, PFHxS, PFOSA, and Et-PFOSA-AcOH. EPA believed that the perfluoroalkyl sulfonate compounds listed under the SNUR were no longer manufactured in the United States; however, during the comment period of the 2007 amendment, EPA learned of the ongoing use of tetraethylammonium perfluorooctanesulfonate as a fume/mist suppressant in metal finishing and plating baths (EPA 2007a). EPA has since excluded this from the list of significant uses. This rule has been amended again by the EPA to designate the processing, use, or importation of long-chain perfluoroalkyls as a significant new use if there are no current ongoing uses, or for uses that were scheduled to end December 31, 2015 (EPA 2015). As part of this amendment, EPA proposed to amend a SNUR for perfluoroalkyl sulfonate chemical substances that would make the exemption inapplicable for persons who import perfluoroalkyl sulfonate chemical substances as part of carpets or any articles that contain long-chain perfluoroalkyls.

In 2006, the eight major companies of the perfluoropolymer/fluorotelomer industry agreed to participate in EPA's PFOA Stewardship Program (EPA 2008a). All public documents and reports from the PFOA Stewardship Program may be reviewed at the EPA docket (EPA-HQ-OPPT-2006-0621). This program included voluntary commitments from these companies to reduce facility emissions and product content of PFOA and related chemicals on a global basis by 95% no later than 2010, and to work toward elimination of these substances in products by 2015. Progress reports have been submitted annually beginning in 2007 and are available from the EPA PFOA Stewardship Program website. Data from these reports that list the content and percent reduction of PFOA, PFOA precursors, and higher PFOA homologues in products are listed in Table 5-1. Nonconfidential emission reports from 2014 and 2015

5. POTENTIAL FOR HUMAN EXPOSURE

obtained from the EPA docket indicate that the companies have met the goals of the program. According to its 2015 emission report to EPA, Solvay Specialty Polymers (formerly Solvay Solexis) ceased using PFOA and related higher homologs in 2010 and ceased importation of products containing PFOA residuals in December 2015 (Jones 2016). DuPont does not use PFOA any longer in the emulsion polymerization of polytetrafluoroethylene (PTFE), replacing it with a processing aid consisting of the ammonium salt of 2,3,3,3-tetrafluoro-2-(heptafluoropropoxy)-propanoate, also known as GenX (Wang et al. 2013b). Similarly, 3M and other manufacturers are using various perfluoropolyethers in fluoropolymer manufacturing and have reformulated surface treatment products to employ short-chain substances that are not as bioaccumulative as the long-chain perfluoroalkyls. Wang et al. (2013b) provide a comprehensive review of the newer substances that manufacturers are using as replacements for legacy perfluoroalkyls in fluoropolymer manufacturing, metal plating, firefighting foams, and other miscellaneous uses such as food packaging materials.

Table 5-1. Content (ppm) and Percent Reduction of PFOA, PFOA Homologues, or PFOA Precursors in Products from 2006 and 2013 U.S. Operations of Fluoropolymer/Fluorotelomer Companies

Company	Chemicals	Dispersions		Other fluoropolymers		Telomers	
		Content	Percent reduction ^a	Content	Percent reduction ^a	Content	Percent reduction ^a
2006 (EPA 2008a)							
Arkema, Inc.	PFOA and higher homologues	>500–1,000	0%	>70–150	30	Not applicable	Not applicable
	Precursors	Not applicable	Not applicable	Not applicable	Not applicable	Not applicable	Not applicable
Asahi Glass Company	PFOA, PFOA salts, and higher homologues	500–1,570	12%	0.12	Not applicable	Not applicable	Not applicable
	Precursors	Not applicable	Not applicable	Not applicable	Not applicable	Not applicable	Not applicable
Ciba Specialty Chemicals Corporation	PFOA	0.05 kg	>99%	0.05 kg	>99%	0.05 kg	>99%
	Higher homologues	0.05 kg	>99%	0.05 kg	>99%	0.05 kg	>99%
	Precursors	0	>99%	0	>99%	0	>99%
Clariant International Ltd.	Not applicable	Not applicable	Not applicable	Not applicable	Not applicable	Not applicable	Not applicable

5. POTENTIAL FOR HUMAN EXPOSURE

Table 5-1. Content (ppm) and Percent Reduction of PFOA, PFOA Homologues, or PFOA Precursors in Products from 2006 and 2013 U.S. Operations of Fluoropolymer/Fluorotelomer Companies

Company	Chemicals	Dispersions		Other fluoropolymers		Telomers	
		Content	Percent reduction ^a	Content	Percent reduction ^a	Content	Percent reduction ^a
Daikin America, Inc.	PFOA	280	34%	2; 300	0%	0.28	72%
	Precursors and higher homologues	Not applicable	Not applicable	Not applicable	Not applicable	2,500	78%
E.I. DuPont de Nemours and Company	PFOA, PFOA salts	547	44%	69	80%	246 kg	50%
	Direct precursors	Not applicable	Not applicable	Not applicable	Not applicable	57 kg	14%
3M/Dyneon	PFOA	0	100%	Not reported	Not reported	Not applicable	Not applicable
Solvay Solexis	PFOA and PFOA salts	600–700	59%	Not applicable	Not applicable	Not applicable	Not applicable
	Higher homologues	Not applicable	Not applicable	170–200	0%	Not applicable	Not applicable
	Precursors	0	Not applicable	Not applicable	Not applicable	Not applicable	Not applicable
2013 (EPA 2016a)							
Arkema, Inc.	PFOA and higher homologues	Not applicable	100%	>25–75	96%	Not applicable	Not applicable
	Precursors	Not applicable	Not applicable	Not applicable	Not applicable	Not applicable	Not applicable
Asahi Glass Company	PFOA, PFOA salts, and higher homologues	0	100%	18	100%	Negligible	Not applicable
	Precursors	Not applicable	Not applicable	Not applicable	Not applicable	Not applicable	Not applicable
BASF (Ciba Specialty Chemicals Corporation)	PFOA and higher homologues	Not applicable	100%	Not applicable	100%	Not applicable	100%
	Precursors	Not applicable	100%	Not applicable	100%	Not applicable	100%
Clariant International Ltd.	PFOA, PFOA salts, and higher homologues	None reported	Not applicable	None reported	Not applicable	<1 kg	Not applicable
	Precursors	None reported	Not applicable	None reported	Not applicable	<7 kg	Not applicable

5. POTENTIAL FOR HUMAN EXPOSURE

Table 5-1. Content (ppm) and Percent Reduction of PFOA, PFOA Homologues, or PFOA Precursors in Products from 2006 and 2013 U.S. Operations of Fluoropolymer/Fluorotelomer Companies

Company	Chemicals	Dispersions		Other fluoropolymers		Telomers	
		Content	Percent reduction ^a	Content	Percent reduction ^a	Content	Percent reduction ^a
Daikin America, Inc.	PFOA	None reported	100%	None reported	100%	None reported	100%
	Precursors and higher homologues	None reported	Not applicable	None reported	Not applicable	None reported	>99%
E.I. DuPont de Nemours and Company	PFOA and PFOA salts	1	99%	0	99%	9 kg	>99%
	Higher homologues	1	99%	0	99%	None reported	99%
	Precursors	None reported	None reported	None reported	None reported	None reported	98%
3M/Dyneon	PFOA, PFOA salts, and higher homologues	0	100%	0	Not applicable	0	No telomere production
	Precursors	No precursor production	No precursor production	No precursor production	No precursor production	No precursor production	No precursor production
Solvay Solexis	PFOA, PFOA salts, and higher homologues	Not applicable	>99.999%	Not applicable	>99.999%	Not applicable	>99.999%
	Precursors	Not applicable	Not applicable	Not applicable	Not applicable	Not applicable	Not applicable

^aPercent reduction in product content of these compounds from baseline year levels. The baseline year is the year nearest to the year 2000 for which company data are available.

PFOA precursors include: Octane, 1,1,1,2,2,3,3,4,4,5,5,6,6,7,7, 8,8-heptadecafluoro-8-iodo- (CAS 507-63-1); 1-Decanol, 3,3,4,4,5,5,6,6,7,7,8,8,9,9,10,10,10-heptadecafluoro- (CAS 678-39-7); 1-Decene, 3,3,4,4,5,5,6,6,7,7,8,8,9,9,10,10,10-heptadecafluoro- (CAS 21652-58-4); 2-Propenoic acid, 3,3,4,4,5,5,6,6,7,7,8,8,9,9,10,10,10-heptadecafluorodecyl ester (CAS 27905-45-9); 2-Propenoic acid, 2-methyl-, 3,3,4,4,5,5,6,6,7,7,8,8,9,9,10,10,10-heptadecafluorodecyl ester (CAS 1996-88-9); 2-Decenoic acid, 3,4,4,5,5,6,6,7,7,8,8,9,9,10,10,10-hexadecafluoro- (CAS 70887-84-2); and Decanoic acid, 3,3,4,4,5,5,6,6,7,7,8,8,9,9,10,10,10-heptadecafluoro- (CAS 27854-31-5).

Higher homologues include: Dodecane, 1,1,1,2,2,3,3,4,4,5,5,6,6,7,7,8,8,9,9,10,10,11,11,12,12-pentacosafuoro-12-iodo (CAS 307-60-8); Decane, 1,1,1,2,2,3,3,4,4,5,5,6,6,7,7,8,8,9,9,10,10-heneicosafuoro-10-iodo- (CAS 423-62-1); Nonanoic acid, heptadecafluoro- (CAS 375-95-1); Decanoic acid, nonadecafluoro- (CAS 335-76-2); 1-Decanol, 3,3,4,4,5,5,6,6,7,7,8,8,9,9,10,10,10-heptadecafluoro- (CAS 678-39-7); Decane, 1,1,1,2,2,3,3,4,4,5,5,6,6,7,7,8,8-heptadecafluoro-10-iodo- (CAS 2043-53-0); Dodecane, 1,1,1,2,2,3,3,4,4,5,5,6,6,7,7,8,8,9,9,10,10-heneicosafuoro-12-iodo- (CAS 2043-54-1); 2-Propenoic acid, 3,3,4,4,5,5,6,6,7,7,8,8,9,9,10,10,10-heptadecafluorodecyl ester (CAS 4980-53-4); and 2-Propenoic acid, 2-methyl-, 3,3,4,4,5,5,6,6,7,7,8,8,9,9,10,10,11,11,12,12-heneicosafuorododecyl ester (CAS 17741-60-5).

CAS = Chemical Abstracts Service; PFOA = perfluorooctanoic acid

5. POTENTIAL FOR HUMAN EXPOSURE

China is one of the few remaining producers and consumers of PFOA and its salts, with a total of 480 metric tons produced from 2004 to 2012 (Li et al. 2015). China also continues to be a producer of PFOS. Growth in production volumes in China have coincided with decreases in production in the west. For example, China produced approximately 30 metric tons of PFOS in 2001; however, as 3M ceased production, China's production of PFOS increased to 91, 165, and 247 metric tons in 2004, 2005, and 2006, respectively (Lim et al. 2011). PFOA production in China was approximately 30 metric tons in 2004, but increased to approximately 90 metric tons in 2012 (Li et al. 2015). According to a report from the Hubei Academy of Environmental Sciences (HAES), China is planning to gradually phase out the production of some PFOS uses before 2019 and conduct a best available technology (BAT)/best environmental practice (BEP) analysis with the ultimate goal of completely phasing out the production and use of PFOS and potential precursors (HAES 2017).

Historical U.S. production volume data for PFOA, PFBA, and PFOS reported by manufacturers under the EPA Inventory Update Rule (IUR) are provided in Table 5-2. Production volume ranges for the ammonium salt of PFOA, APFO, are also listed. During the reporting year 2002, manufacturers reported that the production volumes were within the range of 10,000–500,000 pounds (6–227 metric tons) for PFOS and PFOA and within the range of 500,000–1,000,000 pounds (227–454 metric tons) for APFO (EPA 2008b). PFBA was reported as having a production volume within the range of 10,000–500,000 pounds (6–227 metric tons) during 1986; however, PFBA production volumes were not reported for subsequent years (EPA 2008b). None of the other perfluoroalkyl compounds were listed in EPA's IUR database. Current U.S. production volume data for perfluoroalkyl compounds are limited. The IUR database has been superseded by the Chemical Data Reporting (CDR) database. Data for 2012 indicated that PFOA was not imported into the United States, but any use or production volume data were reported as confidential business information. No data were located in the CDR for the other substances listed in Table 5-2. Nonconfidential emission reports from 2015 obtained from the EPA docket indicate that there is no current production of PFOA or PFOS in the United States.

5. POTENTIAL FOR HUMAN EXPOSURE

Table 5-2. U.S. Production Volume Ranges for Perfluoroalkyls (1986–2002) Reported under the EPA Inventory Update Rule

Perfluoro-alkyl	Reporting year production volume range (pounds)				
	1986	1990	1994	1998	2002
PFOA	10,000–500,000	Not reported	10,000–500,000	10,000–500,000	10,000–500,000
APFO	10,000–500,000	10,000–500,000	10,000–500,000	10,000–500,000	500,000–1,000,000
PFBA	10,000–500,000	Not reported	Not reported	Not reported	Not reported
PFOS	Not reported	Not reported	10,000–500,000	Not reported	10,000–500,000

APFO = ammonium perfluorooctanoate; EPA = Environmental Protection Agency; PFBA = perfluorobutyric acid; PFOA = perfluorooctanoic acid; PFOS = perfluorooctane sulfonic acid

Source: EPA 2008b

5.2.2 Import/Export

The SNURs cited in Section 5.2.1 severely limits the production, import, or export of the long-chain perfluoroalkyls. There were no reported imports of chemicals listed in Table 4-1 in 2012 from the CDR database. Production volumes and import volumes of the 8:2 fluorotelomer alcohol were listed as confidential business information by DuPont. Shaw Industries Group reported that they imported 37,478 pounds of 6:2 fluorotelomer alcohol into the United States in 2012, but DuPont declared both production volume and import volumes as confidential business information (EPA 2016d).

5.2.3 Use

Applications of perfluoroalkyl compounds have made use of their unique surfactant properties (Schultz et al. 2003). The alkyl tails of perfluoroalkyls make these substances both hydrophobic (water-repelling) and oleophobic (oil-repelling) (3M 1999; Kissa 2001; Schultz et al. 2003). Because of these properties, perfluoroalkyls have been used extensively in surface coating and protectant formulations (Kissa 2001). Major applications have included protectants for paper and cardboard packaging products, carpets, leather products, and textiles that enhance water, grease, and soil repellency (Hekster et al. 2003; Schultz et al. 2003). These compounds have been widely used in industrial surfactants, emulsifiers, wetting agents, additives, and coatings as well (3M 1999; Schultz et al. 2003). Perfluoroalkyls have been used in fire-fighting foams since they are effective in extinguishing hydrocarbon fueled fires (Schultz et al. 2003). Perfluoroalkyls have also been used as processing aids in the manufacture of fluoropolymers such as nonstick coatings on cookware, membranes for clothing that are both waterproof and breathable, personal

5. POTENTIAL FOR HUMAN EXPOSURE

care products (such as dental floss, cosmetics, sunscreens), electrical wire casing, fire and chemical resistant tubing, and plumbing thread seal tape (DuPont 2008; EPA 2008a).

5.2.4 Disposal

Information concerning disposal of individual perfluoroalkyl products may be found on Material Safety Data Sheets (MSDS) or Safety Data Sheets (SDS) from the manufacturers of the chemicals. Two methods are generally recommended for the disposal of fluoropolymer dispersions. The first method involves precipitation, decanting, or filtering to separate solids from liquid waste. The dry solids are then disposed of in an approved industrial solid waste landfill or incinerated, while the liquid waste is discharged to a waste water treatment facility (Plastics Europe 2012). The second method involves incineration at temperatures $>800^{\circ}\text{C}$ using a scrubber to remove hydrogen fluoride (Plastics Europe 2012). According to perfluorochemical facility assessment reports, historical disposal of perfluoroalkyl containing waste has been through on- and off-site landfills, through sludge incorporation (subsurface injection), and through incineration (3M 2007b, 2008a; ATSDR 2005). Pilot scale studies in which carpet samples were incinerated using a rotary kiln incinerator indicated that most perfluoroalkyls were effectively destroyed in combustors (Lemieux et al. 2007). Similar conclusions were reached by Yamada et al. (2005) when studying the incineration of textiles and paper treated with fluorotelomer-based acrylic polymers. Incineration at conventional temperatures is a proven technology for treating wastes containing perfluoroalkyls.

5.3 RELEASES TO THE ENVIRONMENT

There is no information listed in EPA's Toxic Release Inventory (TRI) on releases of perfluoroalkyls to the environment from facilities manufacturing, processing, or otherwise using perfluoroalkyls because these releases are not required to be reported within this program (EPA 2005b, 2016g).

Perfluoroalkyls are man-made compounds that are not naturally occurring in the environment. Perfluoroalkyls such as PFOS and PFOA have been widely used in the manufacturing of many consumer products (Hekster et al. 2003; Schultz et al. 2003). These substances are still detected in both environmental and biological media around the world as well as in serum samples collected from the general population (Calafat et al. 2006b, 2007a, 2007b; CDC 2018; De Silva and Mabury 2006; Kuklenyik et al. 2004; Olsen et al. 2003b, 2003c, 2004b, 2004c, 2005, 2007a; Prevedouros et al. 2006).

5. POTENTIAL FOR HUMAN EXPOSURE

In 2006, the eight major companies of the perfluoropolymer/perfluorotelomer industry agreed to participate in EPA's PFOA Stewardship Program (EPA 2008a). This included voluntary commitments from these companies to reduce facility emissions and product content of PFOA and related chemicals on a global basis by 95% no later than 2010, and to work toward elimination of these substances by 2015 (EPA 2008a). Data from 2007 and 2013 progress reports regarding releases of PFOA, PFOA precursors, and higher PFOA homologues to all media as well as percent reduction in releases are listed in Table 5-3.

Table 5-3. Reported Emissions of PFOA, PFOA Homologues, or PFOA Precursors in Products from the 2006 and 2013 U.S. Operations of Fluoropolymer/Fluorotelomer Companies

Company	Chemicals	Releases to all media from fluorotelomer and telomer manufacturing		
		kg	kg of release/100 kg of product produced	Percent reduction in emissions ^a
2006 Data (EPA 2008a)				
Arkema, Inc.	PFOA and higher homologues	>1,000–10,000	For fluorotelomer production: >0.1–1	22%
	Precursors	Not applicable	Not applicable	Not applicable
Asahi Glass Company	PFOA, PFOA salts, and higher homologues	4,922	For fluorotelomer production: <1	6%
	Precursors	Not applicable	Not applicable	Not applicable
BASF (Ciba Specialty Chemicals Corporation)	PFOA	0.05 ^b		>99%
	Higher homologues	0.05 ^b		>99%
	Precursors	0 ^b		>99%
Clariant International Ltd.	Not applicable	Not applicable	Not applicable	Not applicable
Daikin America, Inc.	PFOA	Confidential business information	For fluorotelomer production: 8.0×10^{-3} ; for telomer production: 6.4×10^{-7}	94% for FP production; 92% for telomer production
	Precursors and higher homologues	Confidential business information	For production: 6.4×10^{-7}	22% for telomer production
E.I. DuPont de Nemours and Company	PFOA, PFOA salts	1,100	Not reported	98%
	Direct precursors	Confidential business information	Not reported	Confidential business information

5. POTENTIAL FOR HUMAN EXPOSURE

Table 5-3. Reported Emissions of PFOA, PFOA Homologues, or PFOA Precursors in Products from the 2006 and 2013 U.S. Operations of Fluoropolymer/Fluorotelomer Companies

Company	Chemicals	Releases to all media from fluorotelomer and telomer manufacturing		
		kg	kg of release/100 kg of product produced	Percent reduction in emissions ^a
3M/Dyneon	PFOA	0	0	100%
Solvay Solexis	PFOA and PFOA salts	Not applicable	Not applicable	Not applicable
	Higher homologues	>1,000–10,000	For fluorotelomer production: 0.161	28%
	Precursors	Not applicable	Not applicable	Not applicable
2013 data (EPA 2016a)				
Arkema, Inc.	PFOA and higher homologues	>500–2,000	>0.001–0.005	91%
	Precursors	Not applicable	Not applicable	Not applicable
Asahi Glass Company	PFOA, PFOA salts, and higher homologues	0	Not applicable	100%
	Precursors	Not applicable	Not applicable	Not applicable
BASF (Ciba Specialty Chemicals Corporation)	PFOA	Not applicable	Not applicable	100%
	Precursors	Not applicable	Not applicable	100%
Clariant International Ltd.	PFOA, PFOA salts	Not applicable	Not applicable	Not applicable
	Precursors	Not applicable	Not applicable	Not applicable
Daikin America, Inc.	PFOA	0	0	100%
E.I. DuPont de Nemours and Company	Precursors and higher homologues	0	0	100%
	PFOA, PFOA salts	90	None reported	99.8%
	Higher homologues	None reported	None reported	None reported
	Precursors	Confidential business information	None reported	Confidential business information
3M/Dyneon	PFOA, PFOA salts, and higher homologues	0	0	100%
	Precursors	0	0	Not applicable

5. POTENTIAL FOR HUMAN EXPOSURE

Table 5-3. Reported Emissions of PFOA, PFOA Homologues, or PFOA Precursors in Products from the 2006 and 2013 U.S. Operations of Fluoropolymer/Fluorotelomer Companies

Company	Chemicals	Releases to all media from fluoro-telomer and telomer manufacturing		
		kg	kg of release/100 kg of product produced	Percent reduction in emissions ^a
Solvay Solexis	PFOA, PFOA salts, and higher homologues	0	0	>99.999%
	Precursors	0	0	Not applicable

^aPercent reduction in product content of these compounds from baseline year levels. The baseline year is the year nearest to the year 2000 for which company data are available.

^bTotal for emissions and product content

PFOA = perfluorooctanoic acid

While the United States and most industrialized countries around the world have ceased production of PFOS and PFOA, China is still a major producer of both substances (Li et al. 2015; Lim et al. 2011). Over the period from 2004 to 2012, it was estimated that 250 metric tons of PFOA were released to the environment from production in China (Li et al. 2015). Fluoropolymer manufacturing and processing was considered the dominant source of environmental releases, accounting for >80% of the total, while PFOA releases related to end use consumer products accounted for 6% of the total.

Prevedouros et al. (2006) estimated the total global historical emissions of perfluoroalkyl carboxylates into the environment from both direct and indirect sources from the time period of 1951–2004. These data are provided in Table 5-4. Based on these estimations, direct emissions (3,200–6,900 metric tons) have far exceeded indirect emissions (30–350 metric tons). The largest direct emissions identified are from industrial processes such as the manufacture of perfluoroalkyl carboxylates (470–900 metric tons),

5. POTENTIAL FOR HUMAN EXPOSURE

Table 5-4. Global Historical PFCA Production and Emissions Estimates from 1951 to 2004^a

Environmental input source	Historical time period (years)	Estimated total global historical PFCA emissions (tonnes)
Direct PFCA sources		
PFCA manufacture		
PFO/APFO	1951–2004	400–700
PFN/APFN	1975–2004	70–200
Total manufactured		470–900
Industrial and consumer uses		
Fluoropolymer manufacture (APFO)	1951–2004	2,000–4,000
Fluoropolymer dispersion processing (APFO)	1951–2004	200–300
Fluoropolymer manufacture (APFN)	1975–2004	400–1,400
Fluoropolymer processing (APFN)	1975–2004	10–20
Aqueous firefighting foams (AFFF)	1965–1974	50–100
Consumer and industrial products	1960–2000	40–200
Total direct		3,200–6,900
Indirect PFCA sources		
POSF-based products		
PFCA residual impurities ^b	1960–2002	20–130
POSF-based precursor degradation	1960–2002	1–30
POSF-based AFFF	1970–2002	3–30
Fluorotelomer-based products		
PFCA residual impurities ^b	1974–2004	0.3–30
Fluorotelomer-based precursor degradation	1974–2004	6–130
Fluorotelomer-based AFFF	1975–2004	<1
Total indirect		30–350
Total source emissions (direct and indirect)		3,200–7,300

^aLow and high estimated values as well as the period of use/production for each source are based upon publicly available information cited in the text.

^bSome authors classify residual impurities as a direct emission source rather than indirect emission source (Buck et al. 2011).

AFFF = aqueous firefighting foams; APFN = ammonium perfluorononanoate; APFO = ammonium perfluorooctanoate; PFCA = perfluorinated carboxylic acid; PFN = perfluorononanoate; PFO = perfluorooctanoate; POSF = perfluorooctanesulfonyl fluoride

Source: Prevedouros et al. 2006

5. POTENTIAL FOR HUMAN EXPOSURE

fluoropolymer manufacture (2,400–5,400 metric tons), and fluoropolymer processing (210–320 metric tons). Direct release of perfluoroalkyl carboxylates from use of aqueous firefighting foams and consumer and industrial products were estimated to be 50–100 and 40–200 metric tons, respectively. The largest indirect emissions identified were from perfluoroalkyl carboxylate residual impurities in perfluorooctylsulfonyl fluoride products (20–130 metric tons) and fluorotelomer-based precursor degradation (6–130 metric tons). Wang et al. (2014) expanded upon the work of Prevedouros et al. (2006) by considering additional emission sources of these substances and estimating emissions from 2003 to 2015 and projecting future emissions. These authors estimated emissions of 820–7,180 metric tons for 2003–2015 and projected between 20 and 6,420 metric tons for years 2016–2030. The estimates by Prevedouros et al. (2006) and Wang et al. (2014) contain a great degree of uncertainty as demonstrated by the wide range of values presented in the data. Wang et al. (2014) stated that uncertainty analysis using Monte Carlo methods is not possible because there is insufficient information available with respect to the range or distribution of the emissions. Instead, they introduced a scoring system to provide a qualitative description of the accuracy of the estimates that ranged from 0–1 (low uncertainty) to 2–3 (high uncertainty where estimates were based on crude assumptions or extrapolations).

5.3.1 Air

There is no information listed in the TRI on releases of perfluoroalkyls to the atmosphere from facilities manufacturing, processing, or otherwise using perfluoroalkyls because these releases are not required to be reported (EPA 2005b, 2016g).

According to 3M, low levels of PFOA were released to air during manufacturing processes at the Decatur, Alabama facility until use of this substance ceased in 2004 (3M 2008b). This company states that there are currently no process-related air emissions of PFOA at this facility (3M 2008b). PFOA concentrations as high as 75,000–900,000 pg/m³ were measured at the fence line of the DuPont Washington Works facility near Parkersburg, West Virginia in 2004 (Barton et al. 2006; Davis et al. 2007; Prevedouros et al. 2006). High volume air samples collected at several monitoring stations near the Washington Works facility during nine events between August and October of 2005 contained PFOA at reported concentrations ranging from 10 to 75,900 pg/m³ (EPA 2007b). The mean and median of these reported concentrations are 5,500 and 240 pg/m³.

The presence of perfluoroalkyl compounds in indoor air and dust indicates that perfluoroalkyl-containing consumer products such as treated carpets and textiles may be sources of release to air (Barber et al. 2007; Jahnke et al. 2007b; Kubwabo et al. 2005; Moriwaki et al. 2003; Prevedouros et al. 2006; Shoeib et al.

5. POTENTIAL FOR HUMAN EXPOSURE

2004; Strynar and Lindstrom 2008). Perfluoroalkyl compounds have also been identified on both indoor and outdoor window films (Gewurtz et al. 2009). Disposal of perfluoroalkyl-containing consumer products is also expected to be a source of release to air (Prevedouros et al. 2006). Harada et al. (2005a, 2006) proposed that automobiles may be a source of PFOA in urban air based on elevated levels measured near heavy traffic areas and the widespread use of this substance in automobile materials.

Perfluoroalkyl carboxylic acids and perfluoroalkyl sulfonic acids are formed by the atmospheric photooxidation of precursor compounds such as fluorotelomer alcohols and perfluoroalkyl sulfonamides (D'eon et al. 2006; Ellis et al. 2004; Martin et al. 2006; Wallington et al. 2006; Wania 2007).

Perfluoroalkyl carboxylic acids including PFOA, PFNA, PFHpA, and PFBA were observed as products during a laboratory study involving the photooxidation of 4:2, 6:2, and 8:2 fluorotelomer alcohols (Ellis et al. 2004). D'eon et al. (2006) observed both perfluoroalkyl carboxylic acids and perfluorobutane sulfonate among products of the photooxidation of N-methyl perfluorobutane sulfonamidoethanol.

5.3.2 Water

There is no information listed in the TRI on releases of perfluoroalkyls to water from facilities manufacturing, processing, or otherwise using perfluoroalkyls because these releases are not required to be reported (EPA 2005b, 2016g).

There are a number of sources of perfluoroalkyl release to surface water and groundwater, including release from manufacturing sites, industrial use, use and disposal of perfluoroalkyl-containing consumer products, fire/crash training areas, waste water treatment facilities, and from the use of contaminated biosolids (3M 2008b; Clara et al. 2009; Davis et al. 2007; Eggen et al. 2010; EPA 2009a; Kelly and Solem 2009; Moody and Field 1999; Moody et al. 2003; Sinclair and Kannan 2006; Prevedouros et al. 2006).

Waste water discharge was identified as a release pathway for APFO from the DuPont Washington Works facility in West Virginia (Davis et al. 2007). The average monthly concentrations of APFO measured in surface water from three outlets at the facility during 2007 and early 2008 ranged from 3.65 to 377 µg/L (EPA 2008d). Reported concentrations of APFO and PFOA measured in surface water from four separate outlets at this facility during the same period were 3–64 and 2.3–61 µg/L, respectively. During perfluorochemical operations at the 3M Cottage Grove facility in Minnesota, waste water treatment plant effluent containing perfluoroalkyl compounds was discharged to the Mississippi River.

5. POTENTIAL FOR HUMAN EXPOSURE

Discharge into Bakers Creek from the waste water treatment plant at the 3M Decatur facility was a principal source of PFOA release from this facility (3M 2008b).

Elevated levels of perfluoroalkyls, such as PFOA, PFOS, and PFHxS, measured in groundwater near fire-training areas are attributed to the use of these substances in aqueous firefighting foams (Moody and Field 1999; Moody et al. 2003). The concentrations of these three perfluoroalkyls in groundwater near a military fire-training site in Michigan were 8–105, 4.0–110, and 9–120 $\mu\text{g/L}$, respectively (Moody et al. 2003). A study of landfill leachates showed that perfluoroalkyls were primarily distributed to the water phase of leachates, which could eventually contaminate ground water (Eggen et al. 2010).

Waste water treatment plants have been shown to be significant contributors to perfluoroalkyls contamination of surface and ground water (Clara et al. 2009; EPA 2009a; Kelly and Solem 2009; Loganathan et al. 2007; Sinclair and Kannan 2006; Yu et al. 2009c). Influent, effluent, and sludge samples from 28 public and private waste water treatment plants in Minnesota were analyzed for 13 perfluoroalkyl compounds; detectable concentrations of perfluoroalkyl compounds were found in several facilities, primarily urban treatment plants (Kelly and Solem 2009). Elevated levels of PFOS at one facility (1.51 $\mu\text{g/L}$ in effluent) were attributed to a chrome plating facility using a surfactant containing fluorosulfonate to control hexavalent chromium emissions. Another study of chromium electroplating facilities in Chicago, Illinois and Cleveland, Ohio also found them to be significant sources of PFOS and other perfluoroalkyls in the environment (EPA 2009a). It was determined that perfluoroalkyls were being discharged from all 11 facilities at quantifiable levels and that PFOS was detected in waste water from 10 out of 11 facilities at levels of 0.0314–39 $\mu\text{g/L}$. PFOA and PFOS were detected in effluents of six waste water treatment plants located in New York at levels of 0.058–1.05 and 0.003–0.068 $\mu\text{g/L}$, respectively (Sinclair and Kannan 2006). PFOS and PFOA were detected in effluents of two waste water treatment plants located in Singapore at levels of 0.0053–0.5609 and 0.0112–1.057 $\mu\text{g/L}$, respectively (Yu et al. 2009c). PFOA, PFOS, and several other perfluoroalkyls were detected in effluent samples of 21 waste water treatment plants and 9 industrial point sources; PFOA and PFOS were reportedly identified in the effluents of all of the facilities monitored at an average level of 0.060 $\mu\text{g/L}$ for both substances (Clara et al. 2009).

Studies comparing perfluoroalkyl levels in influent and effluent from municipal waste water treatment facilities have found higher levels of some perfluoroalkyls, such as PFNA, PFOA, PFOS, and PFOSA, in the effluent, as compared to the influent (Loganathan et al. 2007; Schultz et al. 2006b). For others, such as PFHxS and PFDeA, waste water treatment resulted in lower concentrations or no change in the

5. POTENTIAL FOR HUMAN EXPOSURE

concentrations. Increases in perfluoroalkyl concentrations are likely due to the breakdown of perfluoroalkyl precursors such as polyfluoroalkyl phosphoric acids or fluorotelomer alcohols (D'eon et al. 2009; Gauthier and Mabury 2005; Wang et al. 2005a, 2005b).

Land application of biosolids (treated sewage sludge) can also result in the release of perfluoroalkyls to surface and groundwater (Clark and Smith 2011; Lindstrom et al. 2011; Sepulvado et al. 2011). There appears to be some differences in the distribution of PFOA and PFOS in waste water effluent and biosolids, with higher levels of PFOA in waste water and higher PFOS levels in biosolids (Guo et al. 2010).

5.3.3 Soil

There is no information listed in the TRI on releases of perfluoroalkyls to soil from facilities manufacturing, processing, or otherwise using perfluoroalkyls because these releases are not required to be reported (EPA 2005b, 2016g).

Perfluoroalkyls can be inadvertently released to soils through the use of biosolids applied as fertilizer to help maintain productive agricultural soils and stimulate plant growth. PFOA and PFOS were detected in both biosolids and biosolid-amended soils (Sepulvado et al. 2011). Six samples of biosolids obtained from the Metropolitan Water Reclamation District of Greater Chicago had levels of PFOS, Me-PFOA, Et-PFOA, and PFOA of 80–219, 63–143, 42–72, and 8–68 ng/g, respectively (Sepulvado et al. 2011). The mean sum (\pm SD) of all perfluoroalkyls in the biosolids was 433 ± 121 ng/g, with PFOS being most prominent. Perfluoroalkyls can also be released into soil due to atmospheric transport and wet/dry deposition (Rankin et al. 2016; Strynar et al. 2012).

Liu et al. (2007) measured PFOA as a product of the biodegradation of 8:2 fluorotelomer alcohol in soil. This result, along with similar findings in activated sludge tests, indicates that biodegradation of fluorotelomer alcohols may result in the formation of perfluoroalkyl carboxylic acids in soil (Liu et al. 2007; Rankin et al. 2014; Wang et al. 2005a, 2005b).

5. POTENTIAL FOR HUMAN EXPOSURE

5.4 ENVIRONMENTAL FATE**5.4.1 Transport and Partitioning**

Air. Barton et al. (2007) investigated the atmospheric partitioning of PFOA during rain events near an industrial facility and concluded that this substance will be primarily adsorbed to particles in the air since PFOA was not detected in the vapor phase (detection limit of 0.2 ng/m³). Concentrations of PFOA in raindrops and as particulates were 11.3–1,660 ng/L and 0.09–12.40 ng/m³, respectively. The authors proposed that PFOA or APFO released into air from industrial facilities will be scavenged by atmospheric particles (including aqueous aerosols and raindrops) and dissociate to form the perfluorooctanoate anion. Although Barton et al. (2007) did not detect PFOA in the vapor phase during rain events, low concentrations (<0.12–3.16 pg/m³) of vapor-phase perfluoroalkyl compounds measured by Kim and Kannan (2007) in urban air provide evidence of a partitioning equilibrium. Wet and dry deposition are expected to be the principal removal mechanisms for perfluoroalkyl carboxylic acids and sulfonic acids in particulate form from the atmosphere. Residence times with respect to these processes are expected to be days to weeks (Barton et al. 2007; Hurley et al. 2004; Kim and Kannan 2007).

Long-range atmospheric transport of precursor compounds such as fluorotelomer alcohols and perfluoroalkyl sulfonamides followed by the atmospheric photooxidation of these substances to form perfluoroalkyl carboxylic acids and perfluoroalkyl sulfonic acids resulted in PFOA and PFOS contamination in remote locations with no direct point sources for these compounds (Barber et al. 2007; D'eon et al. 2006; Dinglasan-Panlilio and Mabury 2006; Ellis et al. 2004; Martin et al. 2006; Simcik 2005; Small 2009; Wallington et al. 2006; Wania 2007). Fluorotelomer alcohols and perfluoroalkyl sulfonamides are volatile and possess long enough atmospheric residence times for long-range transport to occur (Barber et al. 2007; Yarwood et al. 2007). The presence of fluorotelomer alcohols and perfluoroalkyl sulfonamides in urban and Arctic air offers evidence of long-range atmospheric transport (Loewen et al. 2005; Shoeib et al. 2006; Stock et al. 2004). Photooxidation studies have demonstrated the conversion of these substances to perfluoroalkyl carboxylic acids and sulfonates. According to Young et al. (2007), the presence of perfluorodecanoic acid and perfluoroundecanoic acid in an Arctic ice cap indicates atmospheric oxidation as a source.

Water. With the exception of PFOSA, estimated pKa values for the perfluoroalkyls discussed in this profile range from -0.17 to 3.92 (SPARC 2008). This pKa range indicates that these substances will exist primarily as the dissociated conjugate base (anion) when in contact with water at environmental pH (pH 5–9). Volatilization will not be an important environmental fate process when the substances exist as

5. POTENTIAL FOR HUMAN EXPOSURE

anions; however, under acidic conditions, undissociated perfluoroalkyls may volatilize into the atmosphere (Martin et al. 2006). Perfluoroalkyls may be transported to remote areas by direct oceanic advection of these substances (Armitage et al. 2006; Barber et al. 2007; Simcik 2005; Wania 2007; Yamashita et al. 2005, 2008). Perfluoroalkyls may also be transported over long distances in the form of marine aerosols (Barber et al. 2007; CEMN 2008; Prevedouros et al. 2006). This transport mechanism may be especially relevant since surfactants have been shown to accumulate in upper sea layers and at water surfaces (Prevedouros et al. 2006).

Perfluoroalkyl compounds have been measured in invertebrates, fish, amphibians, reptiles, birds, bird eggs, and mammals located around the world (Dai et al. 2006; Giesy and Kannan 2001; Houde et al. 2005, 2006a, 2006b; Keller et al. 2005; Kannan et al. 2001a, 2001b, 2002a, 2002b, 2002c, 2002d, 2005, 2006; Sinclair et al. 2006; So et al. 2006a; Wang et al. 2008). The highest concentrations of PFOA and PFOS in animals are measured in apex predators, such as polar bears, which indicates that these substances biomagnify in food webs (de Vos et al. 2008; Houde et al. 2006b; Kannan et al. 2005; Kelly et al. 2007). Table 5-5 shows levels of PFOA and PFOS measured in Arctic organisms. The bioaccumulation potential of perfluoroalkyls increases with increasing chain length from 4 to 8 carbon units and then declines with further increases in chain length (Conder et al. 2008; de Vos et al. 2008; Furdui et al. 2007; Martin et al. 2004b). In living organisms, perfluoroalkyls bind to protein albumin in blood, liver, and eggs and do not accumulate in fat tissue, which may explain why bioconcentration factors (BCFs) are lower than expected in aquatic organisms (de Vos et al. 2008; Kissa 2001).

Table 5-5. Biological Monitoring of PFOA and PFOS in the Arctic

Location and organism	Concentration (ng/g)		Reference
	PFOA	PFOS	
Northeastern Canada, 1996–2002; wet weight ^a			Tomy et al. 2004
Zooplankton (n=5)	2.6	1.8	
Clams (n=5)	ND	0.28	
Shrimp (n=7)	0.17	0.35	
Arctic cod (n=6)	0.16	1.3	
Redfish (n=7)	1.2	1.4	
Walrus (n=5)	0.34	2.4	
Narwhal (n=5)	0.9	10.9	
Beluga (n=5)	1.6	12.6	
Black-legged kittiwake (n=4)	ND	10.0	
Glaucous gulls (n=5)	0.14	20.2	

5. POTENTIAL FOR HUMAN EXPOSURE

Table 5-5. Biological Monitoring of PFOA and PFOS in the Arctic

Location and organism	Concentration (ng/g)		Reference
	PFOA	PFOS	
Northern Canada, 1992–2002 ^a			Martin et al. 2004a
Polar bear (n=7)	8.6	3,100	
Arctic fox (n=10)	<2	250	
Ringed seal (n=9)	<2	16	
Mink (n=10)	<2	8.7	
Common loon (n=5)	<2	20	
Northern fulmar (n=5)	<2	1.3	
Black guillemot (n=5)	<2	ND	
White sucker (n=3)	<2	7.6	
Brook trout (n=2)	<2	39	
Lake whitefish (n=2)	<2	12	
Lake trout (n=1)	<2	31	
Northern pike (n=1)	<2	5.7	
Arctic sculpin (n=1)	<2	12	
Northwestern Canada, 2004			Powley et al. 2008
Zooplankton (n=3)	ND	ND–0.2	
Arctic cod (n=5)	ND	0.3–0.7	
Ringed seal (n=5)		2.5–8.6	
Bearded seal (n=1)	ND	1.3	
Northern Norway; ng/g wet weight ^a			Verreault et al. 2005, 2007
Herring gull eggs	<0.091–0.652	21.4–42.2	
Glaucous gulls			
Eggs (n=10)	<0.70	104	
Plasma (n=20)	<0.70–0.74	134	
Nanavut, Canada			Butt et al. 2007a, 2007b
Thick-billed murre	<MDL ^b –0.16	<0.40–0.76	
Northern fulmars	<MDL ^b –0.09	<0.40–0.60	
Ringed seals	<0.85–6.2	2–20	
Northern Canada, 2002–2005			Butt et al. 2008
Ringed seal livers (n=110)	<0.7–13.9	0.89–189	
Greenland			Bossi et al. 2005
Ringed seals	<1.2	12.5–95.6	
North American and European Arctic, 1999–2002			Smithwick et al. 2005a
Polar bears (n>72)	<2.3–57.1	263–6,340	
Greenland, 1999–2001			Smithwick et al. 2005b
Polar bears (n=29) ^a	10	2,470	

5. POTENTIAL FOR HUMAN EXPOSURE

Table 5-5. Biological Monitoring of PFOA and PFOS in the Arctic

Location and organism	Concentration (ng/g)		Reference
	PFOA	PFOS	
Greenland, 1972–2002			Smithwick et al. 2006
Polar bears	1.6–4.4	120–1,400	

^aReported as mean values

^bMinimum detection limits for study analytes ranged from 0.03 to 2.3 ng/g. To calculate means, concentrations less than the MDL were replaced with a random value that was less than half the MDL.

MDL = minimum detection limit; ND = not detected; PFOA = perfluorooctanoic acid; PFOS = perfluorooctane sulfonic acid

Sediment and Soil. K_{oc} values of 17–230 measured for PFOA in soils of various organic carbon content indicate that PFOA will be mobile in soil and will not adsorb to suspended solids and sediment in the water column (Davis et al. 2007; Prevedouros et al. 2006). This is supported by the presence of PFOA in groundwater at the Decatur, Cottage Grove, and Washington Works fluorochemical industrial facilities (3M 2007b, 2008b; Davis et al. 2007). In addition to migration to groundwater from plumes near industrial facilities, other sources of perfluoroalkyls that may contaminate nearby groundwater include air emissions followed by atmospheric deposition to soils and subsequent leaching (Davis et al. 2007). Low volatility, high water solubility (9,500 mg/L at 25°C), and low sorption to solids indicate that the perfluorooctanoate anion will accumulate in surface waters, especially oceans (Armitage et al. 2006; Kauck and Diesslin 1951; Prevedouros et al. 2006; Wania 2007).

Perfluoroalkyl compounds can be taken up by plants in contaminated soils. Laboratory studies have suggested that short-chain perfluoroalkyls such as PFBA are more concentrated in edible portions of plants when compared to longer carbon chain substances such as PFOA or PFOS (Blaine et al. 2013; 2014a, 2014b; MDH 2014). Yoo et al. (2011) studied the accumulation of perfluoroalkyl carboxylic acids, perfluorosulfonic acids, and fluorotelomer alcohols in grass samples collected near Decatur, Alabama and calculated the grass-soil accumulation factor (GSAF), which is the concentration of perfluoroalkyl in grass divided by the concentration of perfluoroalkyl in soil. The shortest chain compounds had the largest GSAFs, and accumulation factors decreased rapidly with chain length. The mean (\pm SD) GSAF values were 3.4 ± 2.6 , 0.90 ± 0.66 , 0.25 ± 0.23 , 0.12 ± 0.08 , 0.10 ± 0.08 , 0.11 ± 0.09 , and 0.10 ± 0.09 for PFHxA, PFHpA, PFOA, PFNA, PFDeA, PFUA, and PFDoA, respectively. The GSAF for PFOS was 0.07 ± 0.04 . Increasing salinity and temperature was shown to increase uptake and transport from the roots into the shoots by the wheat plants grown in hydroponic systems spiked with perfluorocarboxylic acids (Zhao et al. 2016). Transport into the shoots also increased with decreasing

5. POTENTIAL FOR HUMAN EXPOSURE

carbon chain length. Concentrations in the shoots of the wheat plants increased in the following order: PFBA > PFHpA > PFOA > PFDoA.

Other Media. Data are not available regarding the transport and partitioning of perfluoroalkyl compounds in other media.

5.4.2 Transformation and Degradation

Perfluoroalkyl compounds are considered to be environmentally persistent chemicals (EPA 2008a; OECD 2002, 2007; Schultz et al. 2003). The carbon atoms of the perfluoroalkyl chain are protected from attack by the shielding effect of the fluorine atoms; furthermore, environmental degradation processes generally do not possess the energy needed to break apart the strong fluorine-carbon bonds (3M 2000; Hekster et al. 2003; Schultz et al. 2003). Perfluoroalkyl compounds are resistant to biodegradation, direct photolysis, atmospheric photooxidation, and hydrolysis (OECD 2002, 2007; Prevedouros et al. 2006).

Air. Although transport and partitioning information indicates that air will not be a sink for perfluoroalkyl compounds in the environment, low concentrations of perfluoroalkyl carboxylic acids, sulfonic acids, and sulfonamides have been measured in air both in the vapor phase and as bound to particulates (Barton et al. 2007; Kim and Kannan 2007). Available information indicates that photodegradation will not compete with wet deposition as an atmospheric removal process for perfluoroalkyls (Barton et al. 2007; Hurley et al. 2004; Prevedouros et al. 2006). However, photooxidation may be an important degradation mechanism for perfluoroalkyl sulfonamides (D'eon et al. 2006; Martin et al. 2006).

PFOA does not absorb UV light at environmentally relevant wavelengths (>290 nm); Hori et al. (2004a) reported a weak absorption band for PFOA that ranged from 220 to 270 nm. Based on the measured absorption wavelength of PFOA, perfluoroalkyl carboxylic acids are not expected to undergo direct photolysis. Following irradiation of the potassium salt of PFOS with light of wavelength 290–800 nm for 67–167 hours, it was concluded that there was no evidence of direct photolysis of PFOS under any of the test conditions (OECD 2002). Based on these test results for PFOS, perfluoroalkyl sulfonic acids are not expected to undergo direct photolysis in the atmosphere. Direct photolysis data were not located for perfluoroalkyl sulfonic acids.

5. POTENTIAL FOR HUMAN EXPOSURE

A measured photooxidation rate constant is not available for PFOA. Hurley et al. (2004) measured the reaction of short-chain (C1–C4) perfluoroalkyl carboxylic acids with photochemically generated hydroxyl radicals. The proposed mechanism begins with abstraction of the carboxyl hydrogen, which is followed by the removal of the carboxyl group and generation of a perfluoroalkyl radical. Finally, the perfluoroalkyl chain is broken down one carbon atom at a time through an unzipping sequence. The same rate constant, 1.69×10^{-13} cm³/molecule-second, was measured for the photooxidation of the C2, C3, and C4 molecules, indicating that the chain length may have little effect on the reactivity of perfluoroalkyls with hydroxyl radical. According to the authors, this rate constant corresponds to a half-life of 130 days. Based on the data for the short-chain structures, the authors concluded that atmospheric photooxidation of perfluoroalkyl carboxylic acids is not expected to compete with wet and dry deposition, which is predicted to occur on a time scale of the order of 10 days.

Atmospheric photooxidation data are not available for perfluoroalkyl sulfonic acids. Atmospheric photooxidation studies involving n-methyl perfluorobutane sulfonamidoethanol (Me-FBSE) and n-ethyl perfluorobutanesulfonamide (Et-FBSA) indicate possible mechanisms for the reaction of these substances with atmospheric hydroxyl radicals (D'eon et al. 2006; Martin et al. 2006). Products observed from the photooxidation of these compounds indicate the following pathways: removal of an alkyl from the amide (cleavage of the N-C bond); removal of the amido group (cleavage of the S-N bond); and removal of the sulfonamido group (cleavage of the S-C bond) (D'eon et al. 2006; Martin et al. 2006). Each of these pathways would be applicable to the photooxidation of Me- and Et-PFOA-AcOH. The last two pathways indicate that PFOA may be photooxidized through removal of the amido or sulfonamido group. The third pathway, cleavage of the S-C bond, also indicates a photooxidation mechanism for perfluoroalkyl sulfonic acids. Martin et al. (2006) proposes an unzipping sequence for the perfluoroalkyl chain following removal of the sulfonyl group.

Measured rate constants for the reaction of Me-FBSE and Et-FBSA with atmospheric hydroxyl radicals are 5.8×10^{-12} and 3.74×10^{-13} cm³/molecule-second, respectively (D'eon et al. 2006; Martin et al. 2006). Atmospheric half-lives calculated using these rate constants were 2 days for Me-FBSE and 20–50 days for Et-FBSA.

Water. PFOS and PFOA are expected to be stable to hydrolysis in the environment based on half-lives of 41 and 92 years, respectively, calculated from experimental hydrolysis data that were measured at pH 5, 7, and 9 (OECD 2002, 2006b). Based on the data for PFOS and PFOA, hydrolysis is not expected to

5. POTENTIAL FOR HUMAN EXPOSURE

be an important degradation process for perfluorinated carboxylates and sulfonates in the environment. Hydrolysis data were not located for perfluoroalkyl sulfonamides.

Available information indicates that perfluoroalkyl compounds are resistant to aerobic biodegradation. PFOA and PFNA were not biodegraded using an Organisation for Economic Co-operation and Development (OECD) guideline (301F) manometric respirometry screening test for ready biodegradability; 0% of the theoretical oxygen demand was reached after 28 days (Stasinakis et al. 2008). Meesters and Schröder (2004) reported that PFOA and PFOS were not degraded from an initial concentration of 5 mg/L in aerobic sewage sludge in a laboratory scale reactor.

Substances such as fluorotelomer alcohols and perfluoroalkyl sulfonamides are degraded to other substances such as PFOA and PFOS in water and can be considered a source of these substances in the environment (Liu et al. 2007).

Sediment and Soil. Data are not available regarding the transformation and degradation of perfluoroalkyl compounds in sediment and soil. Based on the chemical stability of these substances and their resistance to biodegradation in screening tests, environmental degradation processes are not expected to be important removal mechanisms for perfluoroalkyl compounds in sediment and soil (3M 2000; EPA 2008a; Hekster et al. 2003; OECD 2002, 2007; Prevedouros et al. 2006; Schultz et al. 2003).

Substances such as fluorotelomer alcohols and perfluoroalkyl sulfonamides are degraded to other substances such as PFOA and PFOS in soil and sediment and can be considered a source of these substances in the environment (Liu et al. 2007; Washington and Jenkins 2015; Washington et al. 2015).

Other Media. Data are not available regarding the transformation and degradation of perfluoroalkyl compounds in other media.

5.5 LEVELS IN THE ENVIRONMENT

Reliable evaluation of the potential for human exposure to perfluoroalkyls depends, in part, on the reliability of supporting analytical data from environmental samples and biological specimens. Concentrations of perfluoroalkyls in unpolluted atmospheres and in pristine surface waters are often so low as to be near the limits of current analytical methods. In reviewing data on perfluoroalkyls levels

5. POTENTIAL FOR HUMAN EXPOSURE

monitored or estimated in the environment, it should also be noted that the amount of chemical identified analytically is not necessarily equivalent to the amount that is bioavailable.

Table 5-6 shows the limits of detection typically achieved by analytical analysis in environmental media. An overview summary of the range of concentrations detected in environmental media is presented in Table 5-7.

Table 5-6. Lowest Limit of Detection Based on Standards^a

Media	Detection limit	Reference
Air	0.1 pg/m ³	Harada et al. 2006
Drinking water	0.5–6.5 ng/L	EPA 2009c (Method 537)
Surface water and groundwater	No data	
Soil	0.11–0.75 µg/kg (median reporting limits)	Anderson et al. 2016
Sediment	0.21–1.2 µg/kg (median reporting limits)	Anderson et al. 2016
Whole blood	0.1–2 ng/mL	Kärman et al. 2005
Serum	0.082–0.2 ng/mL	CDC 2015

^aDetection limits based on using appropriate preparation and analytics. These limits may not be possible in all situations.

Table 5-7. Summary of Environmental Levels of Perfluoroalkyls^a

Media	Low	High ^b	For more information
Outdoor air (pg/m ³)	<1	900,000	Table 5-9
Indoor air (pg/m ³)	<5	12,100	Table 5-10
Dust (ng/g)	<2.6	43,765	Table 5-11
Surface water (ppb)	<1	67,000	Tables 5-12, 5-13, 5-14, 5-17
Groundwater (ppb)	<0.1	619	Tables 5-14, 5-17
Drinking water (ppb)	<0.0023	~100	EPA 2010
Ocean water (pg/L)	<0.2	192,000	Table 5-15
Food (ppb)	<1	118.29	Fromme et al. 2007b
Soil (ppb)	<0.17	104,000	Tables 5-16, 5-17

^aFor PFOA or PFOS only.

^bHigh levels are representative of monitoring data at localized contaminated sites and are not reflective of background environmental levels.

5. POTENTIAL FOR HUMAN EXPOSURE

Detections of perfluoroalkyls in air, water, and soil at NPL sites are summarized in Table 5-8.

Table 5-8. Perfluoroalkyls Levels in Water, Soil, and Air of National Priorities List (NPL) Sites

Medium	Median ^a	Geometric mean ^a	Geometric standard deviation ^a	Number of quantitative measurements	NPL sites
PFOA					
Water (ppb)	0.35	0.25	6,064	5	4
Soil (ppb)	18,050	18,050	1,000	2	2
Air (ppbv)	No data				
PFOS					
Water (ppb)	0.91	0.35	9,089	4	3
Soil (ppb)	108,000	108,000	1,000	2	2
Air (ppbv)	No data				
PFBA					
Water (ppb)	2.15	1.03	28,192	3	3
Soil (ppb)	1,600	1,600	1,000	2	2
Air (ppbv)	No data				
PFBuS					
Water (ppb)	0.05	0.02	6,770	2	2
Soil (ppb)	224	224	1,000	2	2
Air (ppbv)	No data				
PFHpA					
Water (ppb)	0.07	0.04	3,169	3	2
Soil (ppb)	1,275	1,275	1,000	2	2
Air (ppbv)	No data				
PFHxA					
Water (ppb)	0.25	0.10	8,444	2	2
Soil (ppb)	1,175	1,175	1,000	2	2
Air (ppbv)	No data				
PFHxS					
Water (ppb)	0.26	1.12	52,496	4	3
Soil (ppb)	5,585	5,585	1,000	2	2
Air (ppbv)	No data				
PFNA					
Water (ppb)	No data				
Soil (ppb)	27.2	27.2	1,000	2	2
Air (ppbv)	No data				

5. POTENTIAL FOR HUMAN EXPOSURE

Table 5-8. Perfluoroalkyls Levels in Water, Soil, and Air of National Priorities List (NPL) Sites

Medium	Median ^a	Geometric mean ^a	Geometric standard deviation ^a	Number of quantitative measurements	NPL sites
PFPeA					
Water (ppb)	0.18	0.11	3,465	3	3
Soil (ppb)	178	178	1,000	2	2
Air (ppbv)	No data				

^aConcentrations found in ATSDR site documents from 1981 to 2017 for 1,854 NPL sites (ATSDR 2017). Maximum concentrations were abstracted for types of environmental media for which exposure is likely. Pathways do not necessarily involve exposure or levels of concern.

5.5.1 Air

Perfluoroalkyl levels have been measured in outdoor air at locations in the United States, Europe, Japan, and over the Atlantic Ocean (Barber et al. 2007; Barton et al. 2006; Harada et al. 2005a, 2006; Kim and Kannan 2007). Concentrations reported in these studies are provided in Table 5-9.

Mean PFOA levels ranged from 1.54 to 15.2 pg/m³ in air samples collected in the urban locations in Albany, New York; Fukuchiyama, Japan; and Morioka, Japan and in the rural locations in Kjeller, Norway and Mace Head, Ireland. Higher mean concentrations (101–552 pg/m³) were measured at the urban locations in Oyamazaki, Japan and Manchester, United Kingdom, and semirural locations in Hazelrigg, United Kingdom. Maximum reported concentrations at Oyamazaki and Hazelrigg were 919 and 828 pg/m³, respectively. The authors attributed the elevated concentrations at the Hazelrigg location to emissions from a fluoropolymer production plant located 20 km upwind of this semirural community.

Elevated levels of PFOA were observed in air samples collected along the fence line of the DuPont Washington Works fluoropolymer manufacturing facility, which is located near Parkersburg, West Virginia, in the Ohio River valley (Barton et al. 2006).

5. POTENTIAL FOR HUMAN EXPOSURE

Table 5-9. Concentrations of Perfluoroalkyl in Outdoor Air

Location	Mean (range) concentration (pg/m ³)			Reference
	PFOA	PFHpA	PFNA	
Urban				
Albany, New York				
Gas phase (n=8)	3.16 (1.89–6.53)	0.26 (0.13–0.42)	0.21 (0.16–0.31)	Kim and Kannan 2007
Particulate phase (n=8)	2.03 (0.76–4.19)	0.37 (<0.12–0.81)	0.13 (<0.12–0.40)	Kim and Kannan 2007
Oyamazaki, Japan (n=12)	262.7 (72–919); 3,412.8 ng/g in dust	—	—	Harada et al. 2005b
Fukuchiyama, Japan	15.2; 314 ng/g in dust	—	—	Harada et al. 2006
Morioka, Japan (n=8)	2.0 (1.59–2.58)	—	—	Harada et al. 2005b
Manchester, United Kingdom (n=2,1) ^a	341, 15.7	8.2, 0.2	<26.6, 0.8	Barber et al. 2007
Rural				
Kjeller, Norway (n=2)	1.54	0.87	0.12	Barber et al. 2007
Mace Head, Ireland (n=4)	8.9	<0.001	<3.3	Barber et al. 2007
Hazelrigg, United Kingdom (semi-rural) (n=10)	101, 552 ^{b,c}	1.6, 14.4 ^b	0.9	Barber et al. 2007
Marine air				
Near Europe (northwest) (n=3)	1.22 (0.5–2.0)	<0.6 (ND–<0.6)	0.3 (ND–0.5)	Jahnke et al. 2007a
Near Africa (east coast) (n=5)	<0.5 (ND–0.7)	ND	<0.2 (ND–0.3)	Jahnke et al. 2007a
Source dominated				
DuPont Washington Works Facility; Parkersburg, West Virginia (n=28)	430,000 (75,000– 900,000) ^d	—	—	Barton et al. 2006
DuPont Washington Works Facility; Parkersburg, West Virginia (n=90)	5,500 (10–75,900)	—	—	EPA 2007b
Location	Mean (range) concentration (pg/m ³)			Reference
	PFDeA	PFUA	PFDoA	
Urban				
Albany, New York				
Gas phase (n=8)	0.63 (0.24–1.56)	<0.12 (ND–0.16)	0.27 (0.14–0.43)	Kim and Kannan 2007
Particulate phase (n=8)	0.27 (0.13–0.49)	ND	0.12 (<0.12–0.38)	Kim and Kannan 2007

5. POTENTIAL FOR HUMAN EXPOSURE

Table 5-9. Concentrations of Perfluoroalkyl in Outdoor Air

Oyamazaki, Japan (n=12)	—	—	—	Harada et al. 2005b	
Fukuchiyama, Japan	—	—	—	Harada et al. 2006	
Morioka, Japan (n=8)	—	—	—	Harada et al. 2005b	
Manchester, United Kingdom (n=2,1) ^a	5.4, <0.8	<0.01, <0.4	<0.01, <0.01	Barber et al. 2007	
Rural					
Kjeller, Norway (n=2)	<0.15	<0.12	<0.12	Barber et al. 2007	
Mace Head, Ireland (n=4)	<2.8	<0.002	<0.003	Barber et al. 2007	
Hazelrigg, United Kingdom (semi-rural) (n=10)	1.0, 8.3 ^b	0.7	<0.01	Barber et al. 2007	
Marine air					
Near Europe (northwest) (n=3)	<0.6 (ND–0.6)	ND	<0.14 (ND–0.17)	Jahnke et al. 2007a	
Near Africa (east coast) (n=5)	ND	0.03 (ND–0.2)	ND	Jahnke et al. 2007a	
Source dominated					
DuPont Washington Works Facility; Parkersburg, West Virginia (n=28)	—	—	—	Barton et al. 2006	
DuPont Washington Works Facility; Parkersburg, West Virginia (n=90)	—	—	—	EPA 2007b	
Mean (range) concentration (pg/m³)					
Location	PFOS	PFBuS	PFHxS	PFOSA	Reference
Urban					
Albany, New York					
Gas phase (n=8)	1.70 (0.94–3.0)	—	0.31 (0.13–0.44)	0.67 (0.22–2.26)	Kim and Kannan 2007
Particulate phase (n=8)	0.64 (0.35–1.16)	—	<0.12	0.29 (<0.12–0.79)	Kim and Kannan 2007
Oyamazaki, Japan (n=12)	5.2 (2.51–9.80); 72.2 ng/g in dust	—	—	—	Harada et al. 2005b
Fukuchiyama, Japan	2.2; 46.0 ng/g in dust	—	—	—	Harada et al. 2006
Morioka, Japan (n=8)	0.7 (0.46–1.19)	—	—	—	Harada et al. 2005b
Manchester, United Kingdom (n=2,1) ^a	46, 7.1	2.2, <1.6	1.0, 0.1	<1.6, <0.2	Barber et al. 2007

5. POTENTIAL FOR HUMAN EXPOSURE

Table 5-9. Concentrations of Perfluoroalkyl in Outdoor Air

Rural					
Kjeller, Norway (n=2)	1.0	<0.09	0.05	0.78	Barber et al. 2007
Mace Head, Ireland (n=4)	<1.8	<1.0	0.07	<0.56	Barber et al. 2007
Hazelrigg, United Kingdom (semi-rural) (n=10)	1.6	2.6	0.04	0.2	Barber et al. 2007
Marine air					
Near Europe (north west) (n=3)	1.36 (0.4–2.5)	ND	0.12 (0.02–0.3)	ND	Jahnke et al. 2007a
Near Africa (east coast) (n=5)	0.544 (0.05–1.9)	ND	0.013 (ND–0.05)	ND	Jahnke et al. 2007a
Source dominated					
DuPont Washington Works Facility; Parkersburg, West Virginia (n=28)	—	—	—	—	Barton et al. 2006
DuPont Washington Works Facility; Parkersburg, West Virginia (n=90)	—	—	—	—	EPA 2007b

^aMean values were reported for separate sampling sessions.

^bThe second concentration reported was measured during an earlier sampling session (n=2).

^cA maximum PFOA concentration of 828 pg/m³ was measured in air at Hazelrigg, United Kingdom.

^dAverage and range of concentrations in 6 out of 28 samples that contained PFOA.

“—” indicates no available data; ND = not detected; PFBuS = perfluorobutane sulfonic acid; PFDeA = perfluorodecanoic acid; PFDoA = perfluorododecanoic acid; PFHpA = perfluoroheptanoic acid; PFHxS = perfluorohexane sulfonic acid; PFNA = perfluorononanoic acid; PFOA = perfluorooctanoic acid; PFOS = perfluorooctane sulfonic acid; PFOSA = perfluorooctane sulfonamide; PFUA = perfluoroundecanoic acid

The reported concentrations in these samples ranged from 75,000 to 900,000 pg/m³. The highest concentrations were measured at locations downwind of the facility. High volume air samples collected at several monitoring stations near the Washington Works facility contained PFOA at reported concentrations ranging from 10 to 75,900 pg/m³ (EPA 2007b). The mean and median of these reported concentrations are 5,500 and 240 pg/m³.

PFOS was detected above quantitation limits in most of the studies, but concentrations were generally below 5 pg/m³. A concentration of 46 pg/m³ was reported in samples from Manchester, United Kingdom. Reported concentrations of other perfluoroalkyls (PFHpA, PFNA, PFDeA, PFUA, PFDoA, PFBuS, PFHxS, and PFOSA) were generally <1 pg/m³ in these studies. PFHpA was detected at slightly higher concentrations (8.2 and 14.4 pg/m³) at Manchester and Hazelrigg, United Kingdom, respectively.

5. POTENTIAL FOR HUMAN EXPOSURE

Jahnke et al. (2007a) collected eight marine air samples during a cruise between Germany and South Africa (53°N to 33°S). Perfluoroalkyl concentrations steadily declined as the sampling moved further from Europe and toward less industrialized regions. Only PFOS was detected in the two samples collected over the Atlantic Ocean east of southern Africa.

Measurements of perfluoroalkyls in snow samples collected from Canadian Arctic ice caps indicate that these substances may be generated in the atmosphere at these locations (Young et al. 2007). Reported concentrations in these snow samples were 2.6–86 pg/L for PFOS, 12–147 pg/L for PFOA, 5.0–246 pg/L for PFNA, <8–22 pg/L for PFDeA, and <6–27 pg/L for PFUA.

The concentration of PFOS measured in rainwater collected during a rain event in Winnipeg, Manitoba was 0.59 ng/L (Loewen et al. 2005). PFOA, PFNA, PFDeA, PFUA, and PFDoA were not detected in the rainwater. Reported method detection limits for these compounds were 7.2, 3.7, 1.7, 1.2, and 1.1 ng/L, respectively.

Studies of perfluoroalkyl concentrations in indoor environments are available (Table 5-10). The reported mean concentrations of perfluoroalkyls measured in four indoor air samples collected from Tromso, Norway were 0.2 pg/m³ for PFOSA, <0.5 pg/m³ for PFBuS, <4.1 pg/m³ for PFHxS, <47.4 pg/m³ for PFOS, 0.8 pg/m³ for PFHpA, 4.4 pg/m³ for PFOA, 2.7 pg/m³ for PFNA, 3.4 pg/m³ in PFDeA, <1.3 pg/m³ for PFUA, and 1.2 pg/m³ for PFDoA (Barber et al. 2007).

Table 5-10. Concentrations of Perfluoroalkyl in Indoor Air

Location	Concentration: mean (range); median (pg/m ³)			Reference
	PFOA	PFHpA	PFNA	
Indoor air (pg/m ³)				
Tromso, Norway (n=4)	4.4	0.8	2.7	Barber et al. 2007
Indoor dust (ng/g)				
Ottawa, Canada (n=67)	106.00 (<2.29–1,234); 19.72 ^a	—	—	Kubwabo et al. 2005
Japan (n=16)	380 (70–3,700); 165	—	—	Moriwaki et al. 2003
North Carolina and Ohio (n=112)	296 (<10.2–1,960); 142 ^b	109 (<12.5–1,150); 50.2 ^b	22.1 (<11.3–263); 7.99 ^b	Strynar and Lindstrom 2008

5. POTENTIAL FOR HUMAN EXPOSURE

Table 5-10. Concentrations of Perfluoroalkyl in Indoor Air

Location	Concentration: mean (range) median (pg/m ³)			Reference	
	PFDeA	PFUA	PFDoA		
Indoor air (pg/m ³)					
Tromso, Norway (n=4)	3.4	<1.3	1.2	Barber et al. 2007	
Indoor dust (ng/g)					
Ottawa, Canada (n=67)	—	—	—	Kubwabo et al. 2005	
Japan (n=16)	—	—	—	Moriwaki et al. 2003	
North Carolina and Ohio (n=112)	15.5 (<9.40–267); 6.65 ^b	30.4 (<10.7–588); 7.57 ^b	18.0 (<11.0–520); 7.78 ^b	Strynar and Lindstrom 2008	
Location	Concentration: mean (range); median (pg/m ³)				Reference
	PFOS	PFBuS	PFHxS	PFOSA	
Indoor air (pg/m ³)					
Tromso, Norway (n=4)	<47.4	<0.5	<4.1	2.8	Barber et al. 2007
Indoor dust (ng/g)					
Ottawa, Canada (n=67)	443.68 (<4.56–5,065); 37.8 ^a	ND ^a	391.96 (<4.56–4,305); 23.1 ^a	<0.99 ^a	Kubwabo et al. 2005
Japan (n=16)	200 (11–2,500); 24.5	—	—	—	Moriwaki et al. 2003
North Carolina and Ohio (n=112)	761 (<8.93–12,100); 201 ^b	41.7 (<12.5–1,150); 9.11 ^b	874 (<12.9–35,700); 45.5 ^b	—	Strynar and Lindstrom 2008

^aMethod detection limits (MDL) and percent below MDL are as follows: PFOA (2.29 ng/g, 37%), PFOS (4.56 ng/g, 33%), PFBuS (1.38 ng/g, 100%), PFHxS (4.56, 15%), and PFOSA (0.99 ng/g, 90%).

^bLimit of quantitation (LOQ) and percent above LOQ are as follows: PFHpA (12.5 ng/g, 74.1%), PFOA (10.2 ng/g, 96.4%), PFNA (11.3 ng/g, 42.9%), PFDeA (9.40 ng/g, 30.4%), PFUA (10.7 ng/g, 36.6%), PFDoA (11.0 ng/g, 18.7%), PFOS (8.93 ng/g, 94.6%), PFHxS (12.9 ng/g, 77.7%), PFBuS (12.5 ng/g, 33.0%). Values below the LOQ were assigned a value of LOQ/1.412 when calculating the median and mean.

“—” indicates no available data; ND = not detected; PFBuS = perfluorobutane sulfonic acid; PFDeA = perfluorodecanoic acid; PFDoA = perfluorododecanoic acid; PFHpA = perfluoroheptanoic acid; PFHxS = perfluorohexane sulfonic acid; PFNA = perfluorononanoic acid; PFOA = perfluorooctanoic acid; PFOS = perfluorooctane sulfonic acid; PFOSA = perfluorooctane sulfonamide

Kubwabo et al. (2005) measured the concentrations of selected perfluoroalkyls in dust samples from 67 Canadian homes. PFOA, PFOS, and PFHxS were each detected in 37, 33, and 15% of these samples, respectively (detection limits of 2.29, 4.56, and 4.56 ng/g, respectively). Mean, median, and range of concentrations in these samples were 106, 19.72, and 1.15–1,234 ng/g, respectively, for PFOA; 443.68, 37.8, and 2.28–5,065 ng/g, respectively, for PFOS; and 391.96, 23.1, and 2.28–4,305 ng/g, respectively, for PFHxS. Concentrations were not reported for PFOSA, which was detected above 0.99 ng/g in 10% of the samples. PFBuS was not detected in any of the samples. Moriwaki et al. (2003) measured PFOS and PFOA concentrations in vacuum cleaner dust samples collected from 16 Japanese homes. PFOS and PFOA were detected in every sample with reported concentrations of 11–140 and 69–380 ng/g,

5. POTENTIAL FOR HUMAN EXPOSURE

respectively, in 15 of the 16 samples. One of the samples contained 2,500 ng/g PFOS and 3,700 ng/g PFOA.

Strynar and Lindstrom (2008) measured perfluoroalkyl levels in 112 indoor dust samples collected from homes and daycare centers in North Carolina and Ohio. These authors detected PFHpA, PFOA, PFNA, PFDeA, PFUA, PFDoA, PFOS, PFHxS, and PFBuS. Mean values ranged from 15.5 to 874 ng/g. PFOS and PFOA were detected in 94.6 and 96.4% of the samples, respectively. Maximum detections in the samples were as high as 12,100 ng/g for PFOS and 35,700 ng/g for PFHxS. Household dust samples collected from the United Kingdom, Australia, Germany, and the United States showed the presence of perfluoroalkyls (Kato et al. 2009a). These data are summarized in Table 5-11.

Table 5-11. Concentration (ng/g) of Perfluoroalkyls in 39 Dust Samples^a

Analyte	25 th percentile	50 th percentile	75 th percentile	Maximum	Frequency of detection (%)
PFBuS	86.3	359.0	782.1	7,718	92.3
PFHxS	47.7	185.5	632.2	43,765	79.5
PFOS	31.7	479.6	1,456.6	18,071	74.4
PFHpA	33.9	97.3	532.5	5,195	61.2
PFOA	<LOQ	96.5	667.7	9,818	64.1
PFNA	<LOQ	<LOQ	26.2	832	25.6
PFDeA	<LOQ	<LOQ	61.0	1,965	38.5
PFUA	<LOQ	<LOQ	<LOQ	732	20.5
PFDoA	<LOQ	<LOQ	37.6	1,048	43.6
PFOSA	<LOQ	<LOQ	16.1	184	23.1
Me-PFOSA-AcOH	<LOQ	<LOQ	110.3	4,520	33.3
Et-PFOSA-AcOH	92.4	243.5	417.9	3,795	87.2

^aThe LOQs are 2.6 ng/g except for PFHpA, which is 4.0 ng/g.

Et-PFOSA-AcOH = 2-(N-ethyl-perfluorooctane sulfonamide) acetic acid; LOQ = limit of quantification; Me-PFOSA-AcOH = 2-(N-methyl-perfluorooctane sulfonamide) acetic acid; PFBuS = perfluorobutane sulfonic acid; PFDeA = perfluorodecanoic acid; PFDoA = perfluorododecanoic acid; PFHpA = perfluoroheptanoic acid; PFHxS = perfluorohexane sulfonic acid; PFNA = perfluorononanoic acid; PFOA = perfluorooctanoic acid; PFOS = perfluorooctane sulfonic acid; PFOSA = perfluorooctane sulfonamide; PFUA = perfluoroundecanoic acid

Source: Kato et al. 2009a

Median levels of PFOS in dust samples collected in homes, apartments, daycare centers, offices, and cars in Sweden were 39, 85, 31, 110, and 12 ng/g, respectively (Björklund et al. 2009). Median PFOA levels in dust samples from the same study were 54, 93, 41, 70, and 33 ng/g in homes, apartments, daycare centers, offices, and cars, respectively. The authors concluded that while dietary intake was the major

5. POTENTIAL FOR HUMAN EXPOSURE

PFOA/PFOS exposure pathway for adults and toddlers in the general population, dust ingestion could become an important pathway under a worst-case scenario (high dust ingestion and maximum dust levels).

5.5.2 Water

PFOS and PFOA have been widely detected in surface water samples collected from various rivers, lakes, and streams in the United States (Boulanger et al. 2004; DRBC 2013; Kannan et al. 2005; Kim and Kannan 2007; Nakayama et al. 2007; Simcik and Dorweiler 2005; Sinclair et al. 2004, 2006). Levels of these substances in surface water appear to be declining since the phase out of these two substances. Zhang et al. (2016) measured surface water levels of 14 perfluoroalkyls in 2014 at 37 sites across the northeastern United States. Although PFOA and PFOS were detected in 100 and 95% of the samples collected, respectively, the levels were lower when compared to measurements of U.S. surface waters from other regions of the country from 2000 to 2009. The maximum concentration of PFOA was 56 ng/L measured in the Passaic River, New Jersey and the maximum PFOS concentration was 27.5 ng/L measured in the Woonasquatucket River, Rhode Island (Zhang et al. 2016).

Less data are available regarding the concentrations of other perfluoroalkyl compounds in surface water. PFHpA and PFHxS were commonly detected in the few studies that analyzed surface water for these compounds (DRBC 2013; Kim and Kannan 2007; Nakayama et al. 2007; Simcik and Dorweiler 2005). Concentrations of PFOA and PFOS measured in surface water are presented in Table 5-12 and other perfluoroalkyls are summarized in Table 5-13. Maximum concentrations of PFOS, PFOA, PFHpA, PFNA, PFDeA, PFUA, PFDoA, PFBuS, and PFHxS measured in surface water collected from the Cape Fear Basin, North Carolina were 287, 132, 329, 194, 120, 52.1, 4.46, 9.41, and 35.1 ng/L, respectively (Nakayama et al. 2007). Much higher concentrations of PFOS (198–1,090 ng/L) have been measured in Onondaga Lake in Syracuse, New York (Sinclair et al. 2006). Onondaga Lake is a Superfund site that has become contaminated through industrial activity along its banks.

5. POTENTIAL FOR HUMAN EXPOSURE

Table 5-12. Concentrations of PFOA and PFOS in Surface Water (ng/L)

Location	Concentration		Reference
	PFOA	PFOS	
Great Lakes			Boulanger et al. 2004
Lake Ontario (n=8)	15–70	6–121	
Lake Erie (n=8)	21–47	11–39	
New York State waters			Sinclair et al. 2006
Lake Ontario (n=13)	18–34	2.9–30	
Niagara River (n=3)	18–22	3.3–6.7	
Lake Erie (n=3)	13–27	2.8–5.5	
Finger Lakes (n=13)	11–20	1.3–2.6	
Onondaga Lake (n=3)	39–64	198–1,090 (median=756)	
Oneida Lake (n=1)	19	3.5	
Erie Canal (n=3)	25–59	5.7–13	
Hudson River (n=8)	22–173 (median=35)	1.5–3.4	
Lake Champlain (n=4)	10–46	0.8–7.7	
Albany, New York			Kim and Kannan 2007
Lake water (n=11)	3.27–15.8 (median=7.20)	ND–9.30 (median=2.88)	
Surface water runoff (n=14)	0.51–29.3 (median=3.80)	<0.25–14.6 (median=0.81)	
New York/New Jersey/Rhode Island metropolitan region	56 (maximum) 3.5 (median)	27.5 (maximum) 0.96 (median)	Zhang et al. 2016
Michigan water regions			Sinclair et al. 2004
Detroit (n=10)	<8–16.14	<0.08–6.13	
Flint (n=4)	<8–23.01	1.50–12.31	
Saginaw Bay (n=5)	<8–24.08	3.10–12.69	
Northeastern Michigan (n=2)	<8	0.87–6.34	
Upper Peninsula (n=7)	<8–13.77	<0.8–3.09	
Northwestern Michigan (n=2)	11.96	<0.8–4.48	
Western Michigan (n=6)	<8–15.17	<0.8–5.32	
Southwestern Michigan (n=5)	8.74–35.86	7.22–29.26	
Lansing (n=3)	<8–13.37	1.04–4.96	

5. POTENTIAL FOR HUMAN EXPOSURE

Table 5-12. Concentrations of PFOA and PFOS in Surface Water (ng/L)

Location	Concentration		Reference
	PFOA	PFOS	
Minnesota Waters and Lake Michigan			Simcik and Dorweiler 2005
Remote (n=4)			
Loiten	0.7	ND	
Little Trout	0.3	1.2	
Nipisiquit	0.1	ND	
Tettegouche	0.5	0.2	
Urban (n=4)			
Calhoun	20	47	
Lake Harriet	3.5	21	
Lake of the Isles	0.5	2.4	
Minnesota River	1.2	9	
Lake Michigan (n=4)	<0.6–0.5	1–3.2	
Cape Fear Basin, North Carolina			Nakayama et al. 2007
80 Sites (n=100)			
Mean	43.4	31.2	
Median	12.6	28.9	
Minimum	ND	<1	
Maximum	287	132	
Percent not detected ^a	7.6	0	
Raisin and St. Clair Rivers, Michigan			Kannan et al. 2005
Raisin River	14.7	3.5	
St. Clair River (n=3)	4.0–5.0	1.9–3.9	
Conasauga River, Georgia	253–1,150	192–318	Konwick et al. 2008
Dalton, Georgia	49.9–299	15.8–120	Konwick et al. 2008
Tidal Delaware River (six locations)			DRBC 2013
2007	3.54–75.40	2.70–8.42	
2008	3.99–48	3.53–11.7	
2009	3.29–27.7	2.86–7.97	
Several rivers in Japan	0.1–67,000	0.3–59	Harada and Koizumi 2009
Lake Victoria Gulf, Kenya	0.4–96.4 (rivers) 0.4–11.6 (lakes)	<0.4–13.23 (rivers); <0.4–2.53 (lakes)	Orata et al. 2009
River Po, Italy	1–1,270	1–25	Loos et al. 2008

^aDetection limit is 0.05 ng/L

ND = not detected; PFOA = perfluorooctanoic acid; PFOS = perfluorooctane sulfonic acid

5. POTENTIAL FOR HUMAN EXPOSURE

Table 5-13. Concentrations of Other Perfluoroalkyls in Surface Water

Location (reference) ^a	Concentration (ng/L)								Et- PFOSA -AcOH
	PFHpA	PFNA	PFDeA	PFUA	PFDoA	PFBuS	PFHxS	PFOSA	
Great Lakes (Boulanger et al. 2004)									
Lake Ontario (n=8)	—	—	—	—	—	—	—	—	<0.3–10
Lake Erie (n=8)	—	—	—	—	—	—	—	—	3–11
New York State waters (Sinclair et al. 2006)									
Onondaga Lake (n=3)	—	—	—	—	—	—	4.2–8.5	—	—
Erie Canal (n=3)	—	—	—	—	—	—	2.5–5.6	—	—
Other lakes and rivers	—	—	—	—	—	—	0.5–2.8	—	—
Albany, New York (Kim and Kannan 2007)									
Lake water (n=11)	1.15– 12.7	ND–3.51	0.25– 3.58	ND–1.45	ND– <0.25	—	<0.25– 4.05	ND– 0.47	—
Surface water runoff (n=14)	<0.25– 6.44	<0.25– 5.90	ND–8.39	ND–1.99	ND–1.60	—	ND–13.5	ND– 2.14	—
New York/New Jersey/Rhode Island metropolitan region (Zhang et al. 2016)									
	48.2 (max); 0.9 (median)	14 (max); 0.4 (median)	5.8 (max); 0.2 (median)	1.9 (max); 0.1 (median)	2.6 (max); 0.0 (median)	6.2 (max); 0.4 (median)	43 (max); 0.7 (median)	—	—
Minnesota waters and Lake Michigan (Simcik and Dorweiler 2005)									
Remote (n=4)									
Loiten	10	ND	ND	—	—	—	—	—	—
Little Trout	4.8	ND	ND	—	—	—	—	—	—
Nipisiquit	0.9	<0.3	ND	—	—	—	—	—	—
Tettegouche	3.1	ND	ND	—	—	—	—	—	—
Urban (n=4)									
Calhoun	11	0.6	0.5	—	—	—	—	—	—
Lake Harriet	2.6	ND	ND	—	—	—	—	—	—
Lake of the Isles	0.4	ND	ND	—	—	—	—	—	—
Minnesota River	0.7	1.9	ND	—	—	—	—	—	—
Lake Michigan (n=4)	<0.6–4.1	<0.6–3.1	ND	—	—	—	—	—	—

5. POTENTIAL FOR HUMAN EXPOSURE

Table 5-13. Concentrations of Other Perfluoroalkyls in Surface Water

Location (reference) ^a	Concentration (ng/L)								Et- PFOSA -AcOH
	PFHpA	PFNA	PFDeA	PFUA	PFDoA	PFBuS	PFHxS	PFOSA	
Cape Fear Basin, North Carolina (Nakayama et al. 2007)									
80 Sites (n=100)									
Mean	38.7	33.6	22.1	10.4	2.17	2.58	7.29	—	—
Median	14.8	5.70	13.2	5.67	1.95	2.46	5.66	—	—
Maximum	329	194	120	52.1	4.46	9.41	35.1	—	—
Percent not detected ^b	32.9	10.1	15.2	17.7	53.2	38.0	45.6	—	—
Raisin and St. Clair Rivers, Michigan (Kannan et al. 2005)									
Raisin River	—	—	—	—	—	—	<1	<10	—
St. Clair River (n=3)	—	—	—	—	—	—	<1	<10	—
Delaware River (6 locations) (DRBC 2013)									
2007	ND- 24.30	1.71-976	ND-9.97	ND-26	ND	—	ND-4.48	ND	—
2008	2.03- 16.3	3.24-650	ND-5.25	ND-11.8	ND	—	BD-3.55	ND	—
2009	1.14- 47.4	1.65-546	ND-1.75	ND-8.3	ND	—	ND-3.62	ND	—

^aSee Table 5-12 for numbers of samples collected at these locations.

^bDetection limit = 0.05 ng/L.

“—” indicates no available data; Et-PFOSA-AcOH = 2-(N-ethyl-perfluorooctane sulfonamide) acetic acid; ND = not detected; PFBuS = perfluorobutane sulfonic acid; PFDeA = perfluorodecanoic acid; PFDoA = perfluorododecanoic acid; PFHpA = perfluoroheptanoic acid; PFHxS = perfluorohexane sulfonic acid; PFNA = perfluorononanoic acid; PFOSA = perfluorooctane sulfonamide; PFUA = perfluoroundecanoic acid

Higher levels perfluoroalkyl compounds are expected in surface water and groundwater surrounding perfluorochemical industrial facilities. Paustenbach et al. (2007) estimated PFOA concentrations in environmental media for communities located near the DuPont Washington Works chemical manufacturing facility. From this analysis, the authors concluded that much of the PFOA detected in groundwater near the facility was attributed to deposition to soil surfaces following atmospheric emissions from the plant followed by subsequent leaching into groundwater. DuPont entered into an agreement with the EPA to collect monitoring data for PFOA in the Ohio River around the DuPont Washington Works facility. In its final phase III assessment, it was reported that levels of PFOA downstream from the facility in 2011 were about an order of magnitude lower than when monitoring began in 2002, while levels upstream essentially remained unchanged (URS 2012). The maximum

5. POTENTIAL FOR HUMAN EXPOSURE

concentration measured in 2011 was 200 ng/L and was obtained from a monitoring location adjacent to the site.

Xiao et al. (2015) summarized soil and groundwater monitoring data of select perfluoroalkyls near the 3M Cottage Grove facility in Minnesota. Groundwater samples for PFBA, PFHxA, PFOA, PFHxS, and PFOS in wells surrounding the site obtained from 2009 to 2013 showed little or no change in concentration over this time period, even though 3M had stopped producing perfluoroalkyls at this facility in 2002. Levels in groundwater were shown to decrease exponentially with distance from the source. A measured PFOA concentration of approximately 20,000 ng/L was observed from a well near the historical unlined disposal site of this facility, but levels decreased to <100 ng/L measured at a distance of 1.4 km away. Some other examples are provided in Table 5-14.

Table 5-14. Concentrations of Perfluoroalkyls in Surface Water and Groundwater at Fluorochemical Industrial Facilities

Location	Percent detection and concentration ($\mu\text{g/L}$)					Reference
	PFOA	PFBA	PFOS	PFHxS	PFBuS	
DuPont Washington Works Facility, West Virginia						
Groundwater						
Borings (n=18)						
Percent detected	89% ^a	—	—	—	—	Davis et al. 2007
Minimum	0.0912 ^a	—	—	—	—	
Maximum	78 ^a	—	—	—	—	
Wells (n=14)						
Percent detected	100% ^a	—	—	—	—	Davis et al. 2007
Minimum	0.081 ^a	—	—	—	—	
Maximum	37.1 ^a	—	—	—	—	
Wells (n=3)						
Percent detected	100%	—	—	—	—	EPA 2008d
Minimum	2.8	—	—	—	—	
Maximum	100	—	—	—	—	
Surface water						
Outlets (n=4)						
Percent detected	100%	—	—	—	—	EPA 2008d
Minimum	2.3	—	—	—	—	
Maximum	61	—	—	—	—	

5. POTENTIAL FOR HUMAN EXPOSURE

Table 5-14. Concentrations of Perfluoroalkyls in Surface Water and Groundwater at Fluorochemical Industrial Facilities

Location	Percent detection and concentration ($\mu\text{g/L}$)					Reference
	PFOA	PFBA	PFOS	PFHxS	PFBuS	
3M Cottage Grove Facility, Minnesota						
Groundwater						
Wells (n=1–7) 3M 2007b						
Percent detected	100%	100%	100%	100%	100%	
Minimum	24.6	23.3	26.0	6.47	2.11	
Maximum	619	318	26.0	40.0	26.1	
Surface water						
East and West Cove (n=3–9) 3M 2007b						
Percent detected	100%	100%	100%	100%	78%	
Minimum	0.172	0.803	0.227	0.0936	0.304	
Maximum	2.79	1.01	3.12	4.58	9.69	
Mississippi River Shoreline (n=52–80) 3M 2007b						
Percent detected	60%	52%	43%	28%	56%	
Maximum	0.760	6.92	0.539	1.04	3.05	
Mississippi River Transect (n=34–44) 3M 2007b						
Percent detected	14%	12%	0%	0%	0%	
Maximum	0.0501	0.0530	ND	ND	ND	
3M Decatur Facility, Alabama						
Groundwater						
Off-site groundwater (n=18) 3M 2008c						
Percent detected	94%	—	—	—	—	
Mean	1.87	—	—	—	—	
Range	0.083–19.8	—	—	—	—	
Off-site groundwater 3M 2010						
Range			0.0404– 2.41	0.0396– 0.622	0.0615– 0.480	
Groundwater range (n=51)	0.149–6.41	0.0104– 1.26	0.012– 0.151	0.0127– 0.0875	0.0101– 0.0766	Lindstrom et al. 2011
Surface water						
On-site surface water (n=7) 3M 2008c						
Percent detected	100%	—	—	—	—	
Median	2.66	—	—	—	—	
Range	0.32–127	—	—	—	—	
Off-site surface water (n=60) 3M 2008c						
Percent detected	98%	—	—	—	—	
Range	0.026–27.7	—	—	—	—	

5. POTENTIAL FOR HUMAN EXPOSURE

Table 5-14. Concentrations of Perfluoroalkyls in Surface Water and Groundwater at Fluorochemical Industrial Facilities

Location	Percent detection and concentration ($\mu\text{g/L}$)					Reference
	PFOA	PFBA	PFOS	PFHxS	PFBuS	
Tennessee River						Hansen et al. 2002
Upstream of facility (n=19)						
Percent detected	0%	—	100%	—	—	
Range	<25	—	16.8–52.6	—	—	
Downstream of facility (n=21)						
Percent detected	0%	—	100%	—	—	
Median	355	—	107	—	—	
Range	<25–598	—	30.3–144	—	—	

^aAnalyte was reported as APFO.

“—” indicates no available data; APFO = ammonium perfluorooctanoate; ND = not detected; PFBA = perfluorobutyric acid; PFBuS = perfluorobutane sulfonic acid; PFHxS = perfluorohexane sulfonic acid; PFOA = perfluorooctanoic acid; PFOS = perfluorooctane sulfonic acid

Yamashita et al. (2005) measured PFOA, PFOS, PFNA, and PFHxS concentrations in ocean water collected from locations in the Atlantic Ocean, Pacific Ocean, and areas near China, Korea, and Japan. These concentrations are listed in Table 5-15. Wei et al. (2007a) measured perfluoroalkyl concentrations in surface seawaters from the western Pacific Ocean, Indian Ocean, and near-Antarctic region. PFOS and PFOA were detected in 60 and 40% of the samples, respectively, with maximum concentrations of 71.7 and 441.6 $\mu\text{g/L}$, respectively. Concentrations of other perfluoroalkyls (PFHxS, PFBuS, PFD_oA, PFD_eA, PFNA, PFHpA) were generally below detection in most samples, with the exceptions being in samples collected near Shanghai, the Philippines, and Indonesia. Maximum concentrations of these perfluoroalkyls ranged from 3.1 to 70.2 $\mu\text{g/L}$ near Shanghai. PFOA, PFOS, and other perfluoroalkyl species were monitored in waste water effluents and 20 rivers located in Japan (Murakami et al. 2008). Perfluoroalkyls were ubiquitous in the river water samples, with concentrations of PFOA as large as 0.054–0.192 $\mu\text{g/L}$ in seven of the river samples with low waste water effluent sources.

Table 5-15. Concentrations of PFOA and PFOS in Ocean Water

Location	Concentration ($\mu\text{g/L}$)			
	PFOA	PFOS	PFNA	PFHxS
North Atlantic (n=9)	160–338	8.6–36	15–36	4.1–6.1
Mid Atlantic (n=7)	100–439	37–73	—	2.6–12
Central to Eastern Pacific (n=14)	15–62	1.1–20	1.0–16	0.1–1.6

5. POTENTIAL FOR HUMAN EXPOSURE

Table 5-15. Concentrations of PFOA and PFOS in Ocean Water

Location	Concentration (pg/L)			
	PFOA	PFOS	PFNA	PFHxS
Western Pacific (n=2)	136–142	54–78	—	2.2–2.8
Tokyo Bay (n=8)	1,800–192,000	338–57,700	163–71,000	17–5,600
Offshore Japan (n=4)	137–1,060	40–75	—	3.0–6.1
Coastal Hong Kong (n=12)	673–5,450	70–2,600	22–207	<5–311
Coastal China (n=14)	243–15,300	23–9,680	2.0–692	<5–1,360
Coastal Korea (n=10)	239–11,350	39–2,530	15–518	<5–1,390
Sulu Sea (n=5)	88–510	<17–109	—	<0.2
South China Sea (n=2)	160–420	8–113	—	<0.2

“—” indicates no available data; PFHxS = perfluorohexane sulfonic acid; PFNA = perfluorononanoic acid; PFOA = perfluorooctanoic acid; PFOS = perfluorooctane sulfonic acid

Source: Yamashita et al. 2005

The presence of PFOA and PFOS in surface water in the United States indicates that drinking water taken from these sources may contain detectable levels of these substances. The most vulnerable drinking water systems are those in close proximity to sites that are contaminated with perfluoroalkyls. PFOA was detected in 12 out of 13 samples collected from four municipal drinking water treatment plants that draw water from the Tennessee River and are located downstream from the 3M Decatur Facility in Alabama. Reported concentrations ranged from 0.025 to 0.16 µg/L (3M 2008c). PFOA was not detected in any samples collected from a fifth plant located upstream of the 3M Decatur facility (3M 2008c).

Hu et al. (2016) presented geospatial monitoring data for six perfluoroalkyls (PFBuS, PFHxS, PFHpA, PFOA, PFOS, and PFNA) in U.S. drinking water from information contained in the EPA third Unregulated Contaminant Monitoring Rule (UCMR 3) program. Frequency of detection and concentrations in drinking water was correlated with proximity to industrial facilities using perfluoroalkyls, military fire training areas, and the number of waste water treatment plants. Under the UCMR 3, the final data indicate that 63 out of 4,920 public water systems (PWSs) reported PFOA and PFOS at concentrations that exceed the EPA Health Advisory of 0.07 µg/L (final UCMR 3 data posted January 2017). These systems represent 1.3% of all of the PWSs that monitored under UCMR 3. Note that UCMR 3 required all large water systems (4,120 PWSs, serving >10,000 people) and a representative sample of 800 small water systems (serving ≤10,000 people) to monitor for PFOA and PFOS from 2013 through 2015. In addition, the results showed that one or more of the other four perfluoroalkyls

5. POTENTIAL FOR HUMAN EXPOSURE

monitored under UCMR 3 were detected above their respective minimum reporting levels at 118 out of 4,920 public water systems (EPA 2017).

It was also reported that 66 public drinking water systems that serve 6 million U.S. residents had at least one sample that exceeded the current EPA health advisory level of 0.07 µg/L for PFOA and PFOS. The dataset used by Hu et al. (2016) has since been updated by the EPA (EPA 2016c). UCMR 3 data are added, removed, or updated following additional reviews by the analytical laboratory conducting the testing, the individual states, and EPA staff. The most recent report dated July 2016 showed that the six perfluoroalkyls were detected above their respective minimal reporting level in 365 out of 4,905 public water systems and that PFOA and PFOS were identified above the health advisory level of 0.07 µg/L in 59 out of the 4,905 public water supplies (EPA 2016c).

Based on a memorandum of understanding with the EPA, DuPont began collecting water monitoring data of both public and private wells near the Washington Works chemical plant. The quarterly reports and monitoring data affiliated with these reports may be obtained from the regulations.gov portal (<http://www.regulations.gov>). In samples of water collected at 17 public water facilities from 2002 to 2009 in West Virginia and Ohio, PFOA levels ranged from below the detection limit (0.0023 µg/L) to nearly 100 µg/L in a few test wells in Little Hocking, Ohio (EPA 2010). In the final phase III summary report, PFOA concentrations were reported to range from below the detection limit to 0.79 µg/L in 34 wells located approximately 3 miles upstream and 82 miles downstream from the facility (URS 2012).

Rumsby et al. (2009) have reviewed the presence of PFOS and PFOA in drinking waters worldwide and discussed treatment methods for removing these substances from public water supplies. Conventional waste water treatment does not always efficiently remove perfluoroalkyls, and effluent may contain higher levels of some perfluoroalkyls than influent due to degradation of precursor substances during the treatment process (Schultz et al. 2006a, 2006b). While granulated activated carbon and reverse osmosis followed by nanofiltration have been shown to be effective methods of removing perfluoroalkyls, conventional methods such as chlorination, ozonolysis, and slow sand filtration may not be as effective. As a consequence, public drinking water systems impacted by effluent from waste water treatment plants often contain higher levels of perfluoroalkyls than systems that are not impacted by waste water treatment plant effluent. Quinones and Snyder (2009) analyzed raw and finished water at seven different public water systems in the United States for the presence of perfluoroalkyls. Water systems that were heavily impacted by waste water treatment plant effluents had greater frequency and higher levels of perfluoroalkyls when compared to water systems that were not highly impacted by waste water treatment

5. POTENTIAL FOR HUMAN EXPOSURE

plants. For example, no perfluoroalkyls were detected in either influent or finished water from a public water system in Aurora, Colorado with no impact from waste water treatment plant effluent; however, PFHxA, PFOA, PFNA, PFDeA, PFUA, PFHxS, and PFOS were detected in all samples of a Los Angeles, California public water system that was highly impacted by waste water effluent. Perfluoroalkyls were commonly detected in the influent and effluent of 10 waste water treatment plants across the United States (Schultz et al. 2006a). PFBuS was detected in 100% of both influent and effluent samples of the 10 plants, while other perfluoroalkyls like PFOA, PFOS, PFNA, PFHxA, PFHpA, and PFHxS were detected in 80% of the influent and effluent samples at the 10 plants. In a national study of 10 perfluoroalkyls in raw and treated drinking water of France, Boiteux et al. (2012) observed that several perfluoroalkyl carboxylic acids had greater concentrations in treated water than the raw water. In eight drinking water treatment plants, PFBA, PFHxA, and PFHpA were not detected in raw water, but were detected in treated water, indicating that these substances were released from saturated activated carbon used to treat raw waters or were formed by the degradation of precursor substances. Perfluoroalkyl sulfonates appeared to be removed more efficiently than the carboxylates. PFHxS, PFBuS, and PFOS were detected less frequently in treated water as compared to raw water influent. These three compounds comprised 53% of the total concentration of perfluoroalkyls in the raw water samples, but only 37% of the total concentration of the perfluoroalkyls in the treated water. The summed concentration of 10 perfluoroalkyls was analyzed in the raw water and treated water of two drinking water treatment plants downstream from a fluoropolymer manufacturing facility located in France (Dauchy et al. 2012). The total concentration of perfluoroalkyls in the raw water at four sampling locations of the first plant ranged from 0.140 to 0.287 µg/L, while the summed concentration in the treated water was 0.179 µg/L. The total concentration of the 10 perfluoroalkyls in raw water at the second plant was 0.132 µg/L, while the total concentration in the treated water was 0.130 µg/L. Levels of PFHxA were greater in the treated water than the raw water at three of the four raw water sampling points, and levels of PFNA were greater in treated water than raw water at all sampling points of the first plant, but were slightly lower in the treated water of the second drinking water plant even though both systems used simple chlorination to treat the water.

According to ATSDR (2008), PFOA, PFOS, PFBA, PFHxS, and PFBuS have been detected in the municipal drinking water of communities located near the 3M Cottage Grove fluorochemical facility. According to Chang et al. (2008a), concentrations of PFBA in precipitation, surface waters, and water treatment effluents were measured in the low ng/L range in effluent at these locations, but could be in the µg/L range in public and private wells.

5. POTENTIAL FOR HUMAN EXPOSURE

PFOA was detected in 65% of the public drinking water systems tested in New Jersey in 2006 at concentrations ranging from 0.005 to 0.039 µg/L (Post et al. 2009). In a follow-up study conducted in 2009, PFOA was detected in 57% of raw water samples from 29 additional public drinking water systems in New Jersey at a maximum concentration of 0.100 µg/L (Post et al. 2013). Nine other perfluoroalkyls were also tested for, with PFOS and PFNA being the most frequently detected compounds (30% detection frequency each) after PFOA. PFOA and PFOS were detected in tap water from 21 cities located in China at concentrations of <0.0001–0.0459 and <0.0001–0.0148 µg/L, respectively (Jin et al. 2009). Mak et al. (2009) published a study comparing detections of perfluoroalkyls including PFOA and PFOS in tap water collected in China, Japan, India, Canada, and the United States. PFOA and PFOS were the predominant species measured, accounting for 40–50% of the total perfluoroalkyls present in water, with the exception of certain location of India where PFOS or PFOA may not have been present or were present at low levels.

Gellrich et al. (2013) analyzed 119 samples of mineral water, 26 samples of tap water, 18 spring water samples, and 14 raw water samples from Germany for the presence of perfluoroalkyls. Perfluoroalkyls were detected in 58% of all of the samples tested, with the greatest summed total concentration observed in tap water at 0.0427 µg/L. The maximum concentration of individual perfluoroalkyls occurring in bottled water, spring water, untreated water, and tap water were observed for PFBuS (0.0133 µg/L), PFOA (0.0074 µg/L), PFBuS (0.010 µg/L), and PFHxS (0.0121 µg/L), respectively. Perfluoroalkyls were widely detected in drinking water samples collected in 2008 at 40 different locations of Catalonia, Spain (Ericson et al. 2009). Median concentrations ranged from 0.00002 µg/L (PFOSA) to 0.00098 µg/L (PFOA). The most frequently detected compounds were PFOS and PFHxS, which were detected in 35 and 31 samples, respectively. PFOS, PFOA, and PFHxS were detected in all samples collected in a study of drinking water contamination of perfluoroalkyls in Rio de Janeiro, Brazil (Quinete et al. 2009). Concentration ranges were 0.00058–0.00670 µg/L (PFOS), 0.00035–0.00282 µg/L (PFOA), and 0.00015–0.001 µg/L (PFHxS) respectively.

5.5.3 Sediment and Soil

Concentrations of perfluoroalkyls in soils are expected to be greater in the vicinity of fluorochemical plants that produced or used these substances as processing aids in the manufacture of fluoropolymers than in the environment at large. Levels of some perfluoroalkyl compounds measured in soil and sediment surrounding perfluorochemical industrial facilities are listed in Table 5-16. PFOA was detected in most soil and sediment samples collected on- and off-site at the 3M Decatur facility in Alabama in

5. POTENTIAL FOR HUMAN EXPOSURE

monitoring studies conducted between October 2004 and December 2006. Maximum soil concentrations were as high as 14,750 ng/g on-site and 7.85 ng/g off-site, and maximum sediment concentrations were as high as 347 ng/g on-site and 2,385 ng/g off-site (3M 2008c). The highest levels of PFOA were measured in soil from on-site fields formerly amended with PFOA-containing sludge. In its final project report for this location, six on-site soil samples were analyzed in December 2012 for the presence of PFOA, PFOS, PFBS, and PFHxS. Average levels were 3.86–3,890 ng/g (PFOS), 3.56–270 ng/g (PFHxS), 0.423–64.8 ng/g (PFBS), and 17.0–1,410 ng/g (PFOA) (3M 2012).

Table 5-16. Concentrations of Perfluoroalkyls in Soil and Sediment at Fluorochemical Industrial Facilities

Location	Percent detection and concentration (ng/g)					Reference
	PFOA	PFBA	PFOS	PFHxS	PFBS	
DuPont Washington Works Facility, West Virginia						
Soil						
Boring samples (n=22)						Davis et al. 2007
Percent detected	36% ^a	—	—	—	—	
Minimum	<0.17 ^a	—	—	—	—	
Maximum	170 ^a	—	—	—	—	
3M Cottage Grove Facility, Minnesota						
Soil						
Boring samples (n=50–108)						3M 2007b
Percent detected	100%	—	95%	90%	60%	
Maximum	21,800	—	104,000	3,470	139	
Fire training area (n=8–11)						3M 2007b
Percent detected	91%	82%	100%	100%	73%	
Maximum	262	11.5	2,948	62.2	24.6	
Sediment						
East and West Cove (n=21–28)						3M 2007b
Percent detected	100%	93%	100%	96%	65%	
Minimum	0.764	ND	40.0	ND	ND	
Maximum	1,845	94.6	65,450	126	9.14	
Mississippi River shoreline (n=84–92)						3M 2007b
Percent detected	70%	44%	80%	28%	29%	
Maximum	341	124	79.0	11.5	29.4	
Mississippi River transect (n=38–40)						3M 2007b
Percent detected	18%	0%	82%	0%	0%	
Maximum	1.09	ND	3.16	ND	ND	

5. POTENTIAL FOR HUMAN EXPOSURE

Table 5-16. Concentrations of Perfluoroalkyls in Soil and Sediment at Fluorochemical Industrial Facilities

Location	Percent detection and concentration (ng/g)					Reference
	PFOA	PFBA	PFOS	PFHxS	PFBuS	
3M Decatur Facility, Alabama						
Soil						
On-site former sludge incorporation area (n=357)						3M 2008c
Percent detected	99%	—	—	—	—	
Mean	885–929					
Range	2.91–14,750	—	—	—	—	
On-site background (n=18)						3M 2008c
Percent detected	100%	—	—	—	—	
Mean	3.53–4.1					
Range	1.61–6.03	—	—	—	—	
Off-site soil (n=23)						3M 2008c
Percent detected	100%	—	—	—	—	
Mean	3.68–4.6					
Range	0.72–7.85	—	—	—	—	
Sediment						
On-site sediment (n=8)						3M 2008c
Percent detected	88%	—	—	—	—	
Median	16.8					
Range	1.64–347	—	—	—	—	
Off-site sediment (n=30)						3M 2008c
Percent detected	93%	—	—	—	—	
Range	0.39–2,385	—	—	—	—	
3M Decatur Facility, Alabama December 2012						
On-site former sludge incorporation area (n=6)						3M 2012
Percent detected	100%	—	100%	86%	86%	
Mean	17.0–1,410	—	3.86– 3,890	3.56– 270	0.423– 64.8	

5. POTENTIAL FOR HUMAN EXPOSURE

Table 5-16. Concentrations of Perfluoroalkyls in Soil and Sediment at Fluorochemical Industrial Facilities

Location	Percent detection and concentration (ng/g)					Reference
	PFOA	PFBA	PFOS	PFHxS	PFBuS	
3M Cottage Grove Facility, Minnesota						
Surface soil along U.S. Highway 10 near facility						Xiao et al. 2015
Percent detected	100%	—	100%	—	—	
Median	8.0		12.2			
Range	5.5–125.7		0.2–28.2			

^aAnalyte was reported as APFO.

“—” indicates no available data; APFO = ammonium perfluorooctanoate; ND = not detected; PFBA = perfluorobutyric acid; PFBuS = perfluorobutane sulfonic acid; PFHxS = perfluorohexane sulfonic acid; PFOA = perfluorooctanoic acid; PFOS = perfluorooctane sulfonic acid

PFOA, PFOS, and PFHxS were detected in 90–100% of soil samples collected from a former tar neutralization area, a former sludge disposal area, a former solids burn pit area, a former waste water treatment plant area, and a former fire training area at the 3M Cottage Grove facility in Minnesota (3M 2007b). PFBuS was detected in 60–73% of these samples. Maximum concentrations for these substances were 21,800, 104,000, 3,470, and 139 ng/g, respectively. Levels of PFBA were only reported for soil in the fire training area; it was detected in 9 out of 11 samples from this location at 0.306–11.5 ng/g. The percent detection of these compounds in sediment from the East and West Cove sites was similar to that in soil. Maximum concentrations of PFOA and PFOS were 1,845 and 65,450 ng/g, respectively. These perfluoroalkyls were also analyzed in Mississippi River sediment near the Cottage Grove Facility. Levels of these compounds were much greater along the facility shoreline compared to levels in transect samples collected at points crossing the river. Maximum shoreline concentrations for PFOA, PFBA, PFOS, PFHxS, and PFBuS were 341, 124, 79.0, 11.5, and 29.4 ng/g, respectively. PFHxS, PFBuS, and PFBA were not detected in any of the transect samples, and PFOA was found in only 18%. Although the maximum concentration of PFOS was 3.16 ng/g, it was still detected in 82% of the transect samples.

PFOA and PFOS were detected in all surface soils (top 10 cm) samples collected at 28 sites in September and October of 2012 along U.S. Highway 10 running from Cottage Grove, Minnesota (where the former 3M perfluoroalkyl manufacturing facility was located) to Big Lake, Minnesota (Xiao et al. 2015). Measured levels of PFOS and PFOA ranged from 0.2 to 28.2 and from 5.5 to 125.7 ng/g, respectively. Subsurface soils up to a depth of 65 cm were collected at four sites as well. Levels of PFOA and PFOS

5. POTENTIAL FOR HUMAN EXPOSURE

generally increased with increasing depth at each of the locations, suggesting a downward movement of the contaminants and the potential to contaminate groundwater.

The use of aqueous firefighting foams at fire training areas of military installations has resulted in widespread contamination of perfluoroalkyl compounds in the soil and groundwater at these facilities. Monitoring data obtained from 40 sites at 10 U.S. military installations in the continental United States and Alaska were collected for several perfluoroalkyls (Anderson et al. 2016). These data are summarized in Table 5-17.

Table 5-17. Summary of Perfluoroalkyl Compounds Detected in Soil, Sediment, Surface Water, and Groundwater at 10 Military Installations^a

Compound	Parameter	Surface soil (µg/kg)	Subsurface soil (µg/kg)	Sediment (µg/kg)	Surface water (µg/L)	Groundwater (µg/L)
PFBA	DF	38.46	29.81	24.24	84.00	85.51
	Median	1.00	0.960	1.70	0.076	0.180
	Maximum	31.0	14.0	140	110	64.0
PFBuS	DF	35.16	34.62	39.39	80.00	78.26
	Median	0.775	1.30	0.710	0.106	0.200
	Maximum	52.0	79.0	340	317	110
PFHxA	DF	70.33	65.38	63.64	96.00	94.20
	Median	1.75	1.04	1.70	0.320	0.820
	Maximum	51.0	140	710	292	120
PFHxS	DF	76.92	59.62	72.73	88.00	94.93
	Median	5.70	4.40	9.10	0.710	0.870
	Maximum	1,300	520	2,700	815	290
PFHpA	DF	59.34	45.19	48.48	84.00	85.51
	Median	0.705	0.660	1.07	0.099	0.235
	Maximum	11.4	17.0	130	57.0	75.0
PFOA	DF	79.12	48.08	66.67	88.00	89.86
	Median	1.45	1.55	2.45	0.382	0.405
	Maximum	58.0	140	950	210	250
PFOSA	DF	64.84	29.81	75.76	52.00	48.55
	Median	1.20	0.470	1.30	0.014	0.032
	Maximum	620	160	380	15.0	12.0
PFOS	DF	98.90	78.85	93.94	96.00	84.06
	Median	52.5	11.5	31.0	2.17	4.22
	Maximum	9,700	1,700	190,000	8,970	4,300
PFNA	DF	71.43	14.42	12.12	36.00	46.38
	Median	1.30	1.50	1.10	0.096	0.105
	Maximum	23.0	6.49	59.0	10.0	3.00

5. POTENTIAL FOR HUMAN EXPOSURE

Table 5-17. Summary of Perfluoroalkyl Compounds Detected in Soil, Sediment, Surface Water, and Groundwater at 10 Military Installations^a

Compound	Parameter	Surface soil (µg/kg)	Subsurface soil (µg/kg)	Sediment (µg/kg)	Surface water (µg/L)	Groundwater (µg/L)
PFDeA	DF	67.03	12.50	48.48	52.00	34.78
	Median	0.980	1.40	1.90	0.067	0.023
	Maximum	15.0	9.40	59.0	3.20	1.80
PFUA	DF	45.05	9.62	24.24	20.00	8.70
	Median	0.798	1.15	160	0.021	0.025
	Maximum	10.0	2.00	14.0	0.210	0.086
PFDoA	DF	21.98	6.73	45.45	20.00	4.35
	Median	1.95	2.40	2.80	0.058	0.022
	Maximum	18.0	5.10	84.0	0.071	0.062

^aWater concentrations are ppb (µg/L); soil and sediment levels are ppb (µg/kg).

DF = detection frequency as a percentage; PFBA = perfluorobutyric acid; PFBuS = perfluorobutane sulfonic acid; PFDoA = perfluorododecanoic acid; PFDeA = perfluoro-n-decanoic acid; PFHpA = perfluoroheptanoic acid; PFHxA = perfluorohexanoic acid; PFHxS = perfluorohexane sulfonic acid; PFNA = perfluorononanoic acid; PFOS = perfluorooctane sulfonic acid; PFOA = perfluorooctane sulfonamide; PFUA = perfluoroundecanoic acid

Source: Anderson et al. (2016)

Perfluoroalkyls have been detected in soils that were amended with biosolids (Sepulvado et al. 2011). Several perfluoroalkyls were detected in biosolid-amended soils, with PFOS being the predominant compound with levels ranging from 5.5 to 483 ng/g, depending upon the loading rate.

5.5.4 Other Media

Levels of PFOS, PFOA, PFBuS, PFHxS, PFHxA, PFHpA, PFDeA, PFNA, and PFDoA were analyzed in 31 food items collected from 5 grocery stores located in Texas in 2009 (Schecter et al. 2010). PFOA was the most frequently detected item (detected in 17 of 31 of the food samples), with levels ranging from 0.07 ng/g in potatoes to 1.80 ng/g in olive oil. PFOS, PFHxA, PFHpA, PFNA, PFDeA, and PFDoA were not detected in any samples. PFBuS and PFHxS were detected in cod at 0.12 and 0.07 ng/g, respectively. The data for PFOA are summarized in Table 5-18. Several studies have evaluated the levels of perfluoroalkyls in fish from lakes and rivers in the United States; these data are summarized in Table 5-19.

5. POTENTIAL FOR HUMAN EXPOSURE

Table 5-18. Detections of PFOA in 31 U.S. Food Items

Food	PFOA concentration in ng/g (LOD for non-detects)
Hamburger	0.15
Bacon	0.24
Sliced turkey	ND (0.02)
Sausage	0.09
Ham	0.02
Sliced chicken breast	0.02
Roast beef	ND (0.02)
Canned chili	0.02
Salmon	0.23
Canned tuna	ND (0.05)
Fresh catfish fillet	0.30
Tilapia	0.10
Cod	0.10
Canned sardines	0.19
Frozen fish sticks	0.21
Butter	1.07
American cheese	ND (0.04)
Other cheese	ND (0.04)
Whole milk	ND (0.02)
Ice cream	ND (0.03)
Frozen yogurt	ND (0.02)
Whole milk yogurt	ND (0.02)
Cream cheese	ND (0.03)
Eggs	ND (0.04)
Olive oil	1.80
Canola oil	ND (0.05)
Margarine	0.19
Cereals	ND (0.04)
Apples	ND (0.02)
Potatoes	0.07
Peanut butter	0.10

LOD = limit of detection; ND = not detected; PFOA = perfluorooctanoic acid

Source: Schechter et al. 2010

5. POTENTIAL FOR HUMAN EXPOSURE

Table 5-19. Detections of Perfluoroalkyls in Fish from U.S. Lakes and Rivers

Type of seafood (location)	Perfluoroalkyl concentration in ng/g										Reference
	PFOA	PFOS	PFHxS	PFNA	PFDeA	PFUA	PFHpA	PFBuS	PFDoA	PFOSA	
Lake trout (Lake Superior)	1.1	4.8	<0.01– 0.43	1.0	0.72	0.90	<0.02– 0.87		0.37	0.25	Furdui et al. 2007
Lake trout (Lake Superior)	<0.42	2.3	<0.10	0.70	0.39	1.1			0.97		DeSilva et al. 2011
Lake trout (Lake Michigan)	4.4	16	<0.01– 0.87	0.57	0.76	0.74	<0.02– 0.97		0.41	0.99	Furdui et al. 2007
Lake trout (Lake Huron)	1.6	39	<0.01– 6.2	2.8	2.2	2.7	<0.02– 1.43		0.88	1.6	Furdui et al. 2007
Lake trout (Lake Huron)	<0.42	17	<0.10	1.4	1.3	1.8			0.74		DeSilva et al. 2011
Lake trout (Lake Erie)	1.6	121	<0.01– 1.2	2.9	4.9	3.5	<0.02– 0.71		0.97	2.1	Furdui et al. 2007
Lake trout (Eastern Lake Erie)	<0.42	96	1.4	2.6	6.1	5.7			2.0		DeSilva et al. 2011
Walleye (Western Lake Erie)	0.50	1.1	<0.10	1.2	3.6	3.1			1.1		DeSilva et al. 2011
Lake trout (Lake Ontario)	1.5	46	0.65	1.1	1.8	1.6	<0.02– 1.39		0.70	0.82	Furdui et al. 2007
Lake trout (Lake Ontario)	0.88	2.5	0.70	0.90	1.4	2.	0.64		0.32		DeSilva et al. 2011
Mixture of whole fish (Missouri River)	<1.00	84.7	1.89	0.43	0.25	<1.00	1.53	<0.40	0.49		Ye et al. 2008
Mixture of whole fish (Mississippi River)	<0.20	83.1	0.42	0.78	1.24	3.38	0.27	<0.20	<0.40		Ye et al. 2008
Mixture of whole fish (Ohio River)	<1.00	147	0.52	1.03	3.88	6.57	<4.00	<0.40	1.72		Ye et al. 2008

5. POTENTIAL FOR HUMAN EXPOSURE

Table 5-19. Detections of Perfluoroalkyls in Fish from U.S. Lakes and Rivers

Type of seafood (location)	Perfluoroalkyl concentration in ng/g										Reference
	PFOA	PFOS	PFHxS	PFNA	PFDeA	PFUA	PFHpA	PFBuS	PFDoA	PFOSA	
Smallmouth bass (Raisin River)	<2	2.0–41.3	<1							<1–4.1	Kannan et al. 2005
Smallmouth bass (St Clair River)	<2	<2–2.7	<1							1.1–6.3	Kannan et al. 2005
Smallmouth bass (Calumet River)	<2	2.5–7.6	<1							<1	Kannan et al. 2005
Carp ^a (Saginaw Bay)	<36	124	<34							<19	Kannan et al. 2005
Carp ^a (Saginaw Bay)		120									Giesy and Kannan 2001
Lake whitefish ^a (Michigan waters)		130									Giesy and Kannan 2001
Chinook salmon ^a (Michigan waters)		110									Giesy and Kannan 2001
Brown trout ^a (Michigan waters)		<6–46									Giesy and Kannan 2001
Bluegill (St Croix River, Minnesota)		2.87			<LOQ	<LOQ			<LOQ		Delinsky et al. 2009
Bluegill (Lake Calhoun, Minnesota)		272			5.82	4.18			4.72		Delinsky et al. 2009
Bluegill (Haw River, North Carolina)		29.8			10.3	26.9			7.25		Delinsky et al. 2009
Mixture of fish fillet (Zumbrol Lake, Minnesota)		52.4			3.24						Delinsky et al. 2010
Mixture of fish fillet (McCarrons Lake, Minnesota)		47.3			1.97						Delinsky et al. 2010

5. POTENTIAL FOR HUMAN EXPOSURE

Table 5-19. Detections of Perfluoroalkyls in Fish from U.S. Lakes and Rivers

Type of seafood (location)	Perfluoroalkyl concentration in ng/g										Reference
	PFOA	PFOS	PFHxS	PFNA	PFDeA	PFUA	PFHpA	PFBuS	PFDoA	PFOSA	
Mixture of fish fillet (Pickerel Lake, Minnesota)		10.0			1.23						Delinsky et al. 2010
Mixture of fish fillet (Carlos Lake, Minnesota)		12.3									Delinsky et al. 2010
Mixture of fish fillet (other Minnesota lakes)		1.08– 5.13									Delinsky et al. 2010
Mixture of fish fillet (Mississippi River sites, Minnesota)		3.06– 20.00	0.47		2.94– 15.0	2.13– 6.72			3.74– 4.42		Delinsky et al. 2010

^aPerfluoroalkyl levels measured in muscle.

LOQ = limit of quantitation; PFBuS = perfluorobutane sulfonic acid; PFDoA = perfluorododecanoic acid; PFDeA = perfluorodecanoic acid; PFHpA = perfluoroheptanoic acid; PFHxS = perfluorohexane sulfonic acid; PFNA = perfluorononanoic acid; PFOS = perfluorooctane sulfonic acid; PFOSA = perfluorooctane sulfonamide; PFUA = perfluoroundecanoic acid

5. POTENTIAL FOR HUMAN EXPOSURE

Concentrations of perfluoroalkyls have been reported in foods sampled in Canada, the United Kingdom, and Germany (Food Standards Agency 2006; Fromme et al. 2007b; Tittlemier et al. 2007).

Perfluoroalkyls were detected in only 9 out of 54 food composites collected during Canadian Total Diet studies from 1992 to 2004 (Tittlemier et al. 2007). PFOS was detected in beef steak, ground beef, luncheon meats, marine fish, freshwater fish, and microwave popcorn at concentrations ranging from 0.98 to 2.7 ng/g, wet weight. PFOA was detected in roast beef, pizza, and microwave popcorn at 0.74–3.6 ng/g, wet weight. PFHpA was detected in pizza and microwave popcorn at 1.5–2.0 ng/g, wet weight. PFNA was detected only in beef steak at 4.5 ng/g, wet weight. PFDeA, PFUA, and PFDoA were analyzed for but not detected in any of the food composites. During the U.K. Food Standards Agency Total Diet Study, PFOS was detected in eggs, sugars and preserves, potatoes, and canned vegetables at 1, 1, 10, and 2 µg/kg, respectively (Food Standards Agency 2006). PFOA was detected only in potatoes at 1 µg/kg. Neither substance was detected in the bread, miscellaneous cereals, carcass meats, offal, meat products, poultry, fish, oils and fats, green vegetables, other vegetables, fresh fruit, fruit products, beverages, milk, dairy products, or nuts categories. Fromme et al. (2007b) detected PFOS, PFOA, and PFHxS in 33, 45, and 3%, respectively, of 214 daily duplicate food portions for 31 adults in the city of Munich, Germany. Concentrations were 0.025–1.03 ng/g fresh weight for PFOS, 0.025–118.29 ng/g fresh weight for PFOA, and 0.05–3.03 ng/g fresh weight for PFHxS. Reported 90th percentile values were 0.11 and 0.21 ng/g fresh weight for PFOS and PFOA, respectively (Fromme et al. 2007b).

The temporal trend of perfluoroalkyl residues in eggs, milk, and farmed rainbow trout from Sweden were studied from 1999 to 2010 (Johansson et al. 2014). Over this period, the mean annual decreases in levels of PFOS were 18 and 31% in rainbow trout and eggs, respectively. The mean annual decreases of PFOA and PFHxS were 12 and 11%, respectively, in eggs. The detection frequency of PFOA and PFHxS was too low in milk samples to assess changes in levels over the time period, and decreases in the levels of PFOS were found to be not statistically significant over the temporal period. The mean annual decrease in levels of PFHxS in rainbow trout was 4.3% annually.

Elevated levels of PFOS were measured in water and fish samples obtained from 2009 and 2012 at six sampling locations along the Welland River and Lake Niapenco in Ontario, Canada (Gewurtz et al. 2014). These locations were downstream from the Hamilton International airport where PFOS containing AFFF was used until the mid-1990s at a firefighting training facility at the airport. PFOS concentrations were generally highest in benthic feeding fish collected at the sampling locations nearest to the airport. The maximum level of PFOS was observed in common carp collected at a site near the airport at a concentration of 2,300 ng/g. Maximum levels of PFOS in smallmouth bass, largemouth bass, and

5. POTENTIAL FOR HUMAN EXPOSURE

channel catfish were 640, 450, and 430 ng/g, respectively. Freshwater fish and seafood obtained from China had detectable levels of nine perfluoroalkyls, with PFOS being detected in 62% of the samples at a concentration range of <0.10–26.2 ng/g and PFOA detected in 70% of the samples at levels of <0.10–1.99 ng/g (Zhang et al. 2011).

PFOA was detected in the packaging paper of two microwave popcorn bags at 0.3–4.7 ng/cm² uncooked and 0.5–4.3 ng/cm² cooked (Sinclair et al. 2007). The mean mass of PFOA in the gas phase of popcorn vapors following popping was 16–17 ng/cm². PFHpA, PFNA, PFDeA, PFUA, and PFDoA were detected in one of the bags at 0.4–3.2 ng/cm² uncooked and 0.5–4.3 ng/cm² cooked; however, these perfluoroalkyls were not detected (<0.2 ng/cm²) in the second bag. Begley et al. (2005) measured PFOA concentrations of 6–290 µg/kg in microwave popcorn bags. These authors also tested a hamburger wrapper, sandwich wrapper, French fry box, and soak-proof paper plates and did not find PFOA above the detection limit in these products. The concentration of PFOA measured in undiluted perfluoro paper coating formulations ranged from 88,000 to 160,000 µg/kg (Begley et al. 2005).

A study of perfluorinated and polyfluorinated substances in food packaging from U.S. fast food restaurants found perfluoroalkyl carboxylates (such as PFOA and PFHxA), perfluoroalkyl sulfonates (such as PFBS), fluorotelomer sulfonates, and unknown polyfluorinated compounds (Schaidler et al. 2017). PFOA was detected in 6 of the 20 samples collected in 2014–2015. Fluorotelomer alcohols that can degrade or metabolize to perfluoroalkyl carboxylic acids such as PFOA continue to be detected in food packaging materials. Yuan et al. (2016) analyzed 69 food contact materials (paper tableware, paper cups, cupcake cups, paper boxes, paper bags, and microwave popcorn bags) produced in China and 25 materials (paper tableware, microwave popcorn bags, and paper cups) produced in the United States. The median concentration of total fluorotelomer alcohols in food contact materials produced in China (sum of 6:2, 8:2, 10:2, 12:2, 14:2, 16:2, and 18:2 fluorotelomer alcohol) ranged from 2 to 18,200 ng/g, with the highest levels observed in microwave popcorn bags. The detection frequencies of 6:2, 8:2, 10:2, 12:2, 14:2, 16:2, and 18:2 fluorotelomer alcohol in all food contact materials were reported as 38, 65, 77, 70, 58, 35, and 30%, respectively. The only fluorotelomer detected in paper tableware produced in the United States was 6:2 fluorotelomer alcohol, with a detection frequency of 11%; however, all fluorotelomer alcohols, with the exception of 18:2 fluorotelomer alcohol, were detected in microwave popcorn bags from the United States, although the levels were much lower than those produced in China. Table 5-20 shows the median concentration of the fluorotelomer alcohols in microwave popcorn bags produced in the United States versus those produced in China. In contrast to the products produced in China, the predominant fluorotelomer alcohol currently detected in food contact materials produced in the

5. POTENTIAL FOR HUMAN EXPOSURE

United States appears to be 6:2 fluorotelomer alcohol. The authors concluded that the results of the PFOA Stewardship Program had effectively reduced the usage of long-chain fluorotelomer alcohols in the United States; however, they were still widely present in products produced in China.

Table 5-20. Fluorotelomer Alcohols Detected in Microwaveable Popcorn Bags Produced in China and the United States

Fluorotelomer alcohol	Median concentration of FTOH in microwave popcorn bag produced in China (ng/g)	Median concentration of FTOH in microwave popcorn bag produced in the United States (ng/g)
6:2 FTOH	80	485
8:2 FTOH	4,810	1.36
10:2 FTOH	6,700	0.73
12:2 FTOH	5,650	0.55
14:2 FTOH	384	0.12
16:2 FTOH	61	<MQL
18:2 FTOH	7.5	Not detected

FTOH = fluorotelomer alcohol; MQL = method quantitation limit

Source: Yuan et al. 2016

Washburn et al. (2005) measured the concentration of the perfluorooctanoate anion in fluorotelomer-treated consumer articles as well as the fluorotelomer formulations used for the treatments. PFOA was detected in mill-treated carpeting (0.2–0.6 mg/kg), carpet-care solution-treated carpeting (0.2–2 mg/kg), treated apparel (<0.02–1.4 mg/kg), treated home textiles (<0.02–1.4 mg/kg), industrial floor waxes and wax removers (0.0005–0.06 mg/kg), latex paint (0.02–0.08 mg/kg), and home and office cleaners (0.005–0.05 mg/kg). The concentrations of PFOA measured in the formulations used for these applications were 30–80, 1–50, <1–40, <1–40, 5–120, 50–150, and 50–150 mg/L, respectively. PFOA was not detected in treated upholstery (<0.034 mg/kg), treated technical textiles (<0.034 mg/kg), treated nonwoven medical garments (<0.034 mg/kg), or stone, tile, and wood sealants (<0.1 mg/kg).

Liu et al. (2014) measured levels of perfluoroalkyls in 35 consumer products that are typically used indoors, such as treated home textiles, food contact paper, carpet care products, and floor waxes. All products were obtained from retail stores in the United States between March 2007 and September 2011. The general trend was that these products contained decreasing quantities of perfluorocarboxylic acids, including PFOA, over the temporal period studied; however, there was an increase in use of PFBS, presumably as a replacement of PFOS in consumer products. Levels of perfluoroalkyls were analyzed in 115 random samples of consumer products obtained in Germany in 2010, including textiles, carpets,

5. POTENTIAL FOR HUMAN EXPOSURE

cleaning and impregnating agents, leathers, food contact materials, baking and sandwich paper, and ski waxes (Kotthoff et al. 2015). Cleaning agents and some baking and sandwich papers had nondetectable or negligible amounts of perfluoroalkyls; however, PFOA and PFOS were frequently detected in outdoor textiles, ski wax, leather products, gloves, awning cloths, nanosprays, impregnation sprays, and food contact materials. Cleaning agents, nanosprays, and impregnation sprays tended to have the highest level of fluorotelomer alcohols. EPA (2009b) analyzed 116 articles of commerce obtained from retail outlets in the United States from March 2007 and May 2008 for the presence of perfluorocarboxylic acids ranging in carbon number from C5 (perfluoropentanoic acid) to C12 (perfluorododecanoic acid). Total C5–C12 perfluorocarboxylic acids levels ranged from below the detection limit (1.5 ng/g) to 47,100 ng/g, with levels of PFOA ranging from below the detection limit to 6,750 ng/g.

PTFE is a fluoropolymer used in applications such as nonstick cookware coatings and plumbing sealant tape. In the past, PFOA had been used as a processing aid in the emulsion polymerization of PTFE (DuPont 2008). PFOA was largely removed from the fluoropolymer material during the baking and curing step of nonstick cookware coatings in a high temperature oven; however, residual PFOA could be found in the final coatings (DuPont 2008). Begley et al. (2005) measured PFOA concentrations of 4–75 µg/kg in PTFE cookware, 3 µg/kg in PTFE-based dental floss, 4 µg/kg in PTFE-based dental tape, and 1,800 µg/kg in PTFE film/sealant tape. PFOA was not detected in tubing made of a fluoro-ethylene-propene copolymer (Begley et al. 2005).

Studies have been conducted that investigated the release of PFOA from PTFE cookware when heated. Sinclair et al. (2007) reported PFOA release concentrations ranging from 19 to 287 pg/cm² measured using four new nonstick frying pans. These concentrations were measured at normal cooking temperatures within the range of 180–229°C. PFOA was detected in water (7 and 75 ng) boiled for 10 minutes in two out of five non-stick pans (Sinclair et al. 2007). PFOA was not found above the detection limit (0.1 ng/cm²) during 40 extraction tests on PTFE cookware using an ethanol/water mixture (Washburn et al. 2005). Likewise, Powley et al. (2005) conducted extraction tests on commercial fluoropolymer-treated cookware using water and water/ethanol mixtures at 100 and 125°C. Under simulated cooking conditions, PFOA was not identified above the detection limit of 100 pg/cm². Begley et al. (2005) reported that additional PFOA was not generated in the PTFE coating of three empty pans heated to 320°C (DuPont 2008). According to DuPont, the non-stick coating on a pan may begin to deteriorate if the pan is accidentally heated above 348°C, which is well above the maximum recommended cooking temperature of 260°C (DuPont 2008). Although it is possible for an unattended

5. POTENTIAL FOR HUMAN EXPOSURE

empty pan to reach these high temperatures, overheating non-stick cookware is expected to be prevented in most cases because food oils begin to generate smoke around 190°C (Begley et al. 2005).

Perfluoroalkyls in indoor and outdoor environments in urban, suburban, and rural locations near Toronto, Ontario, Canada were assessed using window films for passive sampling. The sum of perfluoroalkyls concentrations on outdoor window films ranged from 0.04 to 0.75 pg/cm² in winter and from 0.04 to 0.92 pg/cm² in summer, with higher values found in urban and suburban locations than in rural locations. Indoors, concentrations on window film ranged from less than the detection limit (which ranged from 0.033 to 0.06 pg/cm²) to 2.1 pg/cm² in winter and from 0.08 to 4.3 pg/cm² in summer, although there were no distinct trends between urban and rural for indoor concentrations (Gewurtz et al. 2009).

A comprehensive study that examined 116 articles of commerce (AOC) found perfluorocarboxylic acids, including PFOA, in many commercially available substances, such as carpet care products and waxes (EPA 2009b). Levels of PFOA ranged from nondetectable to 6,750 ng/g, and levels of total perfluorocarboxylic acids (the sum of C5–C12 acids) ranged from nondetectable to 47,100 ng/g. Perfluoroalkyl compounds, including PFOA, have been detected at low levels in personal care products such as cosmetics and sunscreens (Fujii et al. 2013).

5.6 GENERAL POPULATION EXPOSURE

As a group of compounds, perfluoroalkyls appear to be ubiquitous in human blood based on the widespread detection of these substances in human serum samples (Calafat et al. 2006b, 2007a, 2007b; De Silva and Mabury 2006; Kuklennyik et al. 2004; Olsen et al. 2003b, 2003c, 2004b, 2004c, 2005, 2007a). Tables 5-21 and 5-22 list concentrations of perfluoroalkyl compounds measured in serum samples collected from the general population in the United States. There is a clear trend in decreasing serum levels of both PFOS and PFOA in the general population of the United States since 2000 as these substances were phased out.

5. POTENTIAL FOR HUMAN EXPOSURE

Table 5-21. Concentrations of PFOA and PFOS in Human Serum Collected in the United States

Location	Detection and concentration (ng/mL [ppb]) ^a		
	PFOA	PFOS	Reference
U.S. residents—NHANES			
1999–2000 (n=1,562)			Calafat et al. 2007a
Percent >LOD	100%	100%	
LOD	0.1	0.2	
Geometric mean	5.2	30.4	
95th percentile	11.9	75.6	
2003–2004 (n=2,094)			Calafat et al. 2007b
Percent >LOD	99.7%	99.9%	
LOD	0.1	0.4	
Geometric mean	3.95	20.7	
95th percentile	9.80	54.6	
2005–2006 (n=2,120)			
Percent >LOD	NR	NR	CDC 2018
LOD	0.1	0.2	
Geometric mean	3.92	17.1	
95th percentile	11.3	47.5	
2007–2008 (n=2,100)			CDC 2018
Percent >LOD	NR	NR	
LOD	0.1	0.2	
Geometric mean	4.12	13.2	
95th percentile	9.60	40.5	
2009–2010 (n=2,233)			CDC 2018
Percent >LOD	NR	NR	
LOD	0.1	0.2	
Geometric mean	3.07	9.32	
95th percentile	7.50	32.0	
2011–2012 (n=1,904)			CDC 2018
Percent >LOD	NR	NR	
LOD	0.1	0.2	
Geometric mean	2.08	6.31	
95th percentile	5.68	21.7	
2013–2014 (n=2,165)			CDC 2018
Percent >LOD	NR	NR	
LOD	0.1	0.2	
Geometric mean	1.94	4.99	
95th percentile	5.57	18.5	

5. POTENTIAL FOR HUMAN EXPOSURE

Table 5-21. Concentrations of PFOA and PFOS in Human Serum Collected in the United States

Location	Detection and concentration (ng/mL [ppb]) ^a		
	PFOA	PFOS	Reference
U.S. residents			
1990–2002 (n=23 pooled samples)			Calafat et al. 2006b
Percent >LOD	100%	100%	
LOD	0.2	0.4	
Geometric mean	9.6	30.0	
95th percentile	23.0	52.3	
U.S. blood donors			
2000–2001 (n=645)			Olsen et al. 2003b
Percent >LLOQ ^b	92%	99.8%	
Geometric mean	4.6	34.9	
95th percentile ^c	12.1	88.5	
Maximum	52.3	1,656.0	
2006 (n=600)			Olsen et al. 2017b
Geometric mean	3.44	14.5	
95 th percentile	7.9	31.5	
2010 (n=600)			Olsen et al. 2017b
Geometric mean	2.44	8.3	
95 th percentile	5.6	21.8	
2015 (n=616)			Olsen et al. 2017b
Geometric mean	1.09	4.3	
95 th percentile	3.2	8.6	
U.S. residents			
(n=24)			Olsen et al. 2003c
Percent >LLOQ ^d	NR	98%	
Geometric mean	2.5	14.7	
Minimum	<3.0	<6.1	
Maximum	7.0	58.3	
Midwestern United States			
2004–2005 (n=16)			De Silva and Mabury 2006
Percent detected ^d	100%	Not detected	
Mean	4.4		
Maximum	8.6		

5. POTENTIAL FOR HUMAN EXPOSURE

Table 5-21. Concentrations of PFOA and PFOS in Human Serum Collected in the United States

Location	Detection and concentration (ng/mL [ppb]) ^a		Reference
	PFOA	PFOS	
Minneapolis-St. Paul blood donors (plasma)			
2005 (n=40)			Olsen et al. 2007b
Percent >LLOQ	95%	100%	
LLOQ	NR	3.4	
Geometric mean	2.2	15.1	
75th percentile	3.5	20.2	
Maximum	4.7	36.9	
Atlanta, Georgia			
2003 (n=20)			Kuklenyik et al. 2004
Percent >LOD	100%	100%	
LOD	0.1	0.4	
Mean	4.9	55.8	
Minimum	0.2	3.6	
Maximum	10.4	164.0	
Seattle, Washington elderly individuals			
(n=238)			Olsen et al. 2004c
Percent >LLOQ ^b	99.2%	99.5%	
Geometric mean	4.2	31.0	
95th percentile ^b	9.7	84.1	
Maximum	16.7	175.0	
Washington County, Maryland			
1974 (n=178)			Olsen et al. 2005
Percent >LLOQ	71%	100%	
LLOQ	1.9	3.9	
Geometric mean	2.1	30.1	
75th percentile	3.0	40.2	
1989 (n=178)			Olsen et al. 2005
Percent >LLOQ	99% ^o	100% ^p	
Geometric mean	5.5	33.3	
LLOQ	1.9	3.9	
75th percentile	6.7	44.0	

5. POTENTIAL FOR HUMAN EXPOSURE

Table 5-21. Concentrations of PFOA and PFOS in Human Serum Collected in the United States

Location	Detection and concentration (ng/mL [ppb]) ^a		
	PFOA	PFOS	Reference
Boston, Massachusetts; Charlotte, North Carolina; Hagerstown, Maryland; Los Angeles, California; Minneapolis-St. Paul, Minnesota; Portland, Oregon			
2006 (n=600)			Olsen et al. 2008
Percent >LLOQ	99%	99%	
Geometric mean	3.4	14.5	
LLOQ	1.0	<2.5	
95th percentile CI geometric mean	3.3–3.6	13.9–15.2	

^a"Less than" values indicate that the concentration was reported as below the LOD or LLOQ. For cases where samples had concentrations below the limit of detection or lower limit of quantification, a value between zero and the LOD or LLOQ was assigned when calculating the mean concentration.

^bexperimental LLOQs not determined.

^cReported as bias-corrected estimates.

^dLLOQ, LOQ, or LOD not reported.

CI = confidence interval; LLOQ = lower limit of quantification; LOD = limit of detection; NR = not reported; PFOA = perfluorooctanoic acid; PFOS = perfluorooctane sulfonic acid

Table 5-22. Concentrations of Other Perfluoroalkyls in Human Serum Collected in the United States

Sample population	Detection and concentration (ng/mL [ppb]) ^a									
	PFHpA	PFNA	PFDeA	PFUA	PFDoA	PFBuS	PFHxS	PFOSA	Me-PFOSA -AcOH	Et-PFOSA -AcOH
U.S. residents NHANES										
1999–2000 (n=1,562) (Calafat et al. 2007a)										
Percent >LOD	10%	95%	25%	12%	<1%	—	100%	100%	96%	91%
LOD	0.4	0.1	0.2	0.2	0.2	—	0.1	0.05	0.2	0.2
Geometric mean	<0.4	0.5	<0.2	<0.2	<0.2		2.1	0.4	1.0	0.6
95 th percentile	NR	1.7	0.5	NR	NR		8.7	1.4	3.2	2.2
2003–2004 (n=2,094) (Calafat et al. 2007b)										
Percent >LOD	6.2%	98.8%	31.3%	9.7%	<0.1%	<0.4%	98.3%	22.2%	27.5%	3.4%
LOD	0.3	0.1	0.3	0.3	1.0	0.4	0.3	0.2	0.6	0.4
Geometric mean	<0.3	1.0	<0.3	<0.3	<1.0	<0.4	1.9	<0.2	<0.6	<0.4
95 th percentile	0.4	3.2	0.8	0.6	<1.0	<0.4	8.3	0.2	1.3	<0.4

5. POTENTIAL FOR HUMAN EXPOSURE

Table 5-22. Concentrations of Other Perfluoroalkyls in Human Serum Collected in the United States

Sample population	Detection and concentration (ng/mL [ppb]) ^a									
	PFHpA	PFNA	PFDeA	PFUA	PFDoA	PFBuS	PFHxS	PFOSA	Me-PFOSA -AcOH	Et-PFOSA -AcOH
2005–2006 (n=2,120) (CDC 2018)										
Percent >LOD	NR	NR	NR	NR	NR	NR	NR	NR	NR	NR
LOD	0.4	0.1	0.2	0.2	0.2	0.1	0.1	0.1	0.174	0.2
Geometric mean	—	1.09	0.355	—	—	—	1.67	—	0.410	—
95 th percentile	0.700	3.60	1.50	0.700	<LOD	0.1	8.30	0.300	1.57	0.300
2007–2008 (n=2,100) (CDC 2018)										
Percent >LOD	NR	NR	NR	NR	NR	NR	NR	NR	NR	NR
LOD	0.4	0.082	0.2	0.2	0.2	0.1	0.1	0.1	0.174	0.2
Geometric mean	—	1.22	0.286	—	—	—	1.95	—	0.303	—
95 th percentile	0.500	3.28	0.900	0.600	<LOD	<LOD	9.80	<LOD	1.30	<LOD
2009–2010 (n=2,233) (CDC 2018)										
Percent >LOD	NR	NR	NR	NR	NR	NR	NR	NR	NR	NR
LOD	0.1	0.082	0.1	0.1	0.1	0.1	0.1	0.1	0.087	0.1
Geometric mean	—	1.26	0.279	0.172	—	—	1.66	—	0.198	—
95 th percentile	0.200	3.77	0.900	0.900	<LOD	<LOD	6.90	<LOD	1.00	0.100
2011–2012 (n=1,904) (CDC 2018)										
Percent >LOD	NR	NR	NR	NR	NR	NR	NR	NR	NR	NR
LOD	0.1	0.1	0.1	0.1	0.1	0.1	0.1	0.1	0.1	0.1
Geometric mean	—	0.881	0.199	—	—	—	1.28	—	—	—
95 th percentile	0.220	2.54	0.690	0.620	0.140	<LOD	5.44	<LOD	0.690	0.110
2013–2014(n=2,168) (CDC 2018)										
Percent >LOD	NR	NR	NR	NR	NR	NR	NR	NR	NR	NR
LOD	0.1	0.1	0.1	0.1	0.1	0.1	0.1	0.1	0.1	
Geometric mean	—	0.675	0.185	—	—	—	1.35	NR	—	NR
95 th percentile	0.200	2.00	0.700	0.500	0.200	<LOD	5.60	NR	0.600	NR

5. POTENTIAL FOR HUMAN EXPOSURE

Table 5-22. Concentrations of Other Perfluoroalkyls in Human Serum Collected in the United States

Sample population	Detection and concentration (ng/mL [ppb]) ^a									
	PFHpA	PFNA	PFDeA	PFUA	PFDoA	PFBuS	PFHxS	PFOSA	Me-PFOSA-AcOH	Et-PFOSA-AcOH
U.S. residents (Calafat et al. 2006b)										
1990–2002 (n=23 pooled samples)										
Percent >LOD	0%	8.7%	0%	13%	0%	—	91.3%	26.1%	13%	56.5%
LOD	0.3	0.1	0.3	0.3	1	—	0.3	0.2	0.6	0.4
Geometric mean	NA	<0.3	NA	<0.3	NA	—	1.6	<0.4	<0.6	<0.4
95 th percentile	NA	0.3	NA	1.3	NA	—	2.7	0.7	1.9	2.5
U.S. blood donors (Olsen et al. 2003b)										
2000–2001 (n=645)										
Percent >LLOQ ^c	—	—	—	—	—	—	52%	2%	40%	42%
Geometric mean	—	—	—	—	—	—	1.9	NR	1.3	2.0
95 th percentile ^b	—	—	—	—	—	—	9.5	NR	5.0	7.6
Maximum	—	—	—	—	—	—	66.3	NR	16.4	60.1
U.S. blood donors (Olsen et al. 2017a, 2017b)										
2006 (n=600)										
Percent>LLOQ	62%	100%	99.8%	99.8%	68%	1.2%	95.7%	—	62.4%	1.7%
LLOQ ^d	<0.5	NR	<0.05	<0.05	<0.05	<0.5	<0.5	—	<1.3	<1.0
Geometric mean	0.09	0.97	0.34	0.18	0.04	LLOQ	1.52	—	0.60	LLOQ
95 th percentile	0.4	2.2	0.8	0.5	0.07	LLOQ	5.7	—	1.8	LLOQ
2010 (n=600)										
Percent>LLOQ	79.7%	100%	100%	99.8%	46.2%	22.5%	95.5%	—	—	—
LLOQ ^d	<0.05	NR	NR	<0.025	<0.025	<1.0	<0.05	—	—	—
Geometric mean	0.05	0.83	0.27	0.14	0.03	LLOQ	1.34	—	—	—
95 th percentile	0.2	2.3	0.8	0.5	0.06	0.3	5.3	—	—	—
2015 (n=616)										
Percent>LLOQ	3.3%	100%	96.9%	47.9%	0.6%	8.4%	99.7%	0%	63.1%	8.2%
LLOQ ^d	<0.09	<0.093	<0.093	<0.466	<0.932	<0.047	<0.04	<0.093	<0.09	<0.23
Geometric mean	—	0.43	0.15	—	—	LLOQ	0.87	LLOQ	0.09	LLOQ
95 th percentile	0.16	1.1	0.49	0.25	LLOQ	0.02	3.5	LLOQ	0.43	0.05

5. POTENTIAL FOR HUMAN EXPOSURE

Table 5-22. Concentrations of Other Perfluoroalkyls in Human Serum Collected in the United States

Sample population	Detection and concentration (ng/mL [ppb]) ^a									
	PFHpA	PFNA	PFDeA	PFUA	PFDoA	PFBuS	PFHxS	PFOSA	Me-PFOSA -AcOH	Et-PFOSA -AcOH
U.S. residents (Olsen et al. 2003c)										
(n=24)										
Geometric ^e mean	—	—	—	—	—	—	1.8	3.0	—	—
Minimum							<1.2	<1.3		
Maximum							5.9	22.1		
Midwestern United States (De Silva and Mabury 2006)										
2004–2005 (n=16)										
Percent detected ^e	—	100%	100%	13%	0%	—	—	—	—	—
Mean		0.77	0.17	NR	NA					
Maximum		1.2	0.25	0.067	NA					
Atlanta, Georgia (Kuklenyik et al. 2004)										
2003 (n=20)										
Percent >LOD	10%	100%	75%	85%	10%	—	100%	75%	100%	90%
LOD								0.2	0.6	0.4
Mean ^b	<0.3	2.6	0.7	0.8	<1		3.9	0.34	1.7	0.9
Maximum	8.5	3.9	1.2	1.4	1.6		11.2	0.7	5.2	1.4
Seattle, Washington (Olsen et al. 2004c)										
(n=238)										
Percent >LLOQ ^c	—	—	—	—	—	—	76%	"Few"	65%	52%
Geometric mean							2.2	NR	1.2	<1.6
95th percentile ^b							8.3	NR	3.8	7.8
Maximum							40.3	NR	6.6	21.1
Washington County, Maryland (Olsen et al. 2005)										
1974 (n=178)										
Percent >LLOQ	—	—	—	—	—	—	63%	0%	4%	33%
LLOQ							1.4		1.0	1.6
Geometric mean							1.5	NA	0.5	1.2
75th percentile							2.5	NA	<1.0	1.8

5. POTENTIAL FOR HUMAN EXPOSURE

Table 5-22. Concentrations of Other Perfluoroalkyls in Human Serum Collected in the United States

Sample population	Detection and concentration (ng/mL [ppb]) ^a									
	PFHpA	PFNA	PFDeA	PFUA	PFDoA	PFBuS	PFHxS	PFOSA	Me-PFOSA-AcOH	Et-PFOSA-AcOH
1989 (n=178)										
Percent >LLOQ	—	—	—	—	—	—	82%	0%	38%	93%
LLOQ							1.4		1.0	1.6
Geometric mean							2.5	NA	0.8	3.6
75th percentile							1.6	NA	1.3	4.7

^a"Less than" values indicate that the concentration was reported as below the LOD or LLOQ. For cases where samples had concentrations below the LOD or LLOQ, a value between zero and the LOD or LLOQ was assigned when calculating the mean concentration.

^bReported as bias-corrected estimates.

^cExperimental LLOQs not determined.

^dhighest LLOQ listed.

^eLOD not reported.

"—" indicates no available data; Et-PFOSA-AcOH = 2-(N-ethyl-perfluorooctane sulfonamide) acetic acid; LLOQ = lower limit of quantification; LOD = limit of detection; Me-PFOSA-AcOH = 2-(N-methyl-perfluorooctane sulfonamide) acetic acid; NA = not applicable; NR = not reported; PFBuS = perfluorobutane sulfonic acid; PFDeA = perfluorodecanoic acid; PFDoA = perfluorododecanoic acid; PFHpA = perfluoroheptanoic acid; PFHxS = perfluorohexane sulfonic acid; PFNA = perfluorononanoic acid; PFOSA = perfluorooctane sulfonamide; PFUA = perfluoroundecanoic acid

Calafat et al. (2007a, 2007b) analyzed serum levels of different subsamples of the general population during the 1999–2000 and 2003–2004 periods of the NHANES. The numbers of individuals included in the analyses for each survey period were 1,562 and 2,094, respectively. PFOA, PFOS, PFNA, and PFHxS were detected in 95–100% of serum samples collected during both survey periods. In an analysis of NHANES data from 1999 to 2008, Kato et al. (2011) found that males had significantly higher levels of PFOA, PFOS, and PFNA than females and that PFOS levels increased with age, especially in females. An upward trend of PFNA levels and a downward trend for PFHxS levels were also noted. Mean concentrations for PFOA, PFOS, and PFHxS declined by 10–30% in the 2003–2004 survey, while PFNA values doubled from 0.5 to 1.0 ng/mL. NHANES survey data from 2005–2006, 2007–2008, 2009–2010, 2011–2012, and 2013–2014 have generally continued to show declining levels of PFOA and PFOS in human serum samples (CDC 2015, 2018). A dramatic difference in detection frequency was observed for PFOSA, Me-PFOSA-AcOH, and Et-PFOSA-AcOH, which were widely detected (91–100%) during the 1999–2000 survey period but were present in only 3.4–27.5% of samples collected during the 2003–2004 survey period. PFDoA and PFBuS were detected in <1% of the NHANES samples. The geometric mean serum concentration of PFOS has declined nearly 80% from NHANES survey years 1999–2000 to 2013–

5. POTENTIAL FOR HUMAN EXPOSURE

2014 and the geometric mean serum levels of PFOA have declined nearly 70% over the same temporal period. Olsen et al. (2008) reported a nearly 60% decline in PFOS blood levels when comparing data from 2001 to 2006 American Red Cross surveys of participants.

Levels of perfluoroalkyl compounds have been measured in indoor air, outdoor air, dust, food, surface water, and various consumer products. Possible exposure pathways have been proposed; however, the relative importance of these pathways, including their association with the accumulation of perfluoroalkyls in blood, remains unclear (Apelberg et al. 2007b; Begley et al. 2005; Calafat et al. 2006b; Trudel et al. 2008; Washburn et al. 2005). For populations that have elevated levels of perfluoroalkyls in water supplies, the primary route of exposure is expected to be ingestion of contaminated drinking water. Using a stratified random sample of residents in the Little Hocking Water district in Ohio between July 2004 and February 2005, Emmett et al. (2006a) reported median serum PFOA levels of 329 ng/mL in residents of households with a median drinking water concentration of 3.55 ng/mL. Median serum PFOA levels were 371 ng/mL in residents for whom this was the only residential water source and 71 ng/mL in those who used bottled, cistern, or spring water. Increased serum PFOA was associated with increasing number of drinks of tap water daily and also with increasing use of water for making soups and stews and in-home canning of fruits and vegetables. Use of a carbon water filter reduced PFOA levels by about 25%. In a follow-up study, 231 study participants in the Little Hocking Water District were evaluated 15 months later with 88% using bottled water exclusively; 8% had made other changes to their ingestion of residential water including use of activated carbon water filters. PFOA levels had decreased an average of 26% from the initial levels (Emmett et al. 2009).

A study conducted by the Minnesota Department of Health reported higher PFOA, PFHxS, and PFOS serum levels in residents of two communities with contaminated water supplies as compared to the general population (MDH 2009). Similar findings have been reported by Steenland et al. (2009a) in a study of residents in six water districts in the mid-Ohio Valley located near the DuPont Washington Works facility in Washington, West Virginia. The Minnesota Department of Health instituted a program to reduce levels of perfluoroalkyls in drinking water that included using granulated activated carbon (GAC) filters for home use in areas where private wells showed high levels of contamination and large GAC filters for the municipal water supplies (MDH 2009). In two Mid-Ohio Valley locations with PFOA-contaminated drinking water, blood serum levels of PFOA in residents declined significantly following the implementation of GAC filtration of the public water supply (Bartell et al. 2010). The Lubeck, West Virginia and Little Hocking, Ohio public water systems, which were contaminated with PFOA from the DuPont Washington Works facility, began GAC treatment to remove PFOA from the

5. POTENTIAL FOR HUMAN EXPOSURE

potable water supply in 2007. The average decrease in serum PFOA levels for Lubeck, West Virginia residents primarily consuming public water at home (n=130) was 26% a year after treatment began. Similar trends were reported for residents of Little Hocking, Ohio. The average decrease in PFOA serum levels for residents primarily consuming public water (n=39) was about 11% 6 months after treatment began (Bartell et al. 2010).

Trudel et al. (2008) provide a thorough analysis of general population exposure to PFOS and PFOA based on the available information and have proposed the following possible exposure pathways: food and water consumption, ingestion of house dust, hand-to-mouth transfer from treated carpets, migration into food from PFOA-containing paper or cardboard, inhalation of indoor and ambient air, and inhalation of impregnation spray aerosols. Other pathways proposed to be less significant included oral exposure from hand-to-mouth contact with clothes and upholstery, migration into food prepared with PTFE-coated cookware, dermal exposure from wearing treated clothes, deposition of spray droplets on skin while impregnating, skin contact with treated carpet and upholstery, and deposition of dust onto skin (Trudel et al. 2008). The strong correlation between PFOA and PFOS concentrations in human serum samples indicates that common exposure pathways for these two substances are possible (Calafat et al. 2007a).

In order to estimate human uptake and the major pathways for human exposure to PFOS and PFOA, reported levels of these compounds in various environmental media, including food and consumer products, were analyzed with respect to product use patterns, personal activity patterns, and personal intake rates (Trudel et al. 2008). For PFOS, the major exposure pathways in a high-exposure scenario were proposed to be food and water ingestion, dust ingestion, and hand-to-mouth transfer from mill-treated carpets. Relative contributions of these pathways to the total uptake of PFOS in adults were estimated to be approximately 80, 15, and 5%, respectively (Trudel et al. 2008). For PFOA, the major exposure pathways in a high-exposure scenario were proposed to be oral exposure resulting from migration from paper packaging and wrapping into food, general food and water ingestion, inhalation from impregnated clothes, and dust ingestion. Relative contributions of these pathways to the total uptake of PFOA in adults were estimated to be approximately 60, 15, 15, and 10%, respectively (Trudel et al. 2008). Major exposure pathways for the intermediate and low exposure scenarios were proposed to be through food and drinking water (PFOA and PFOS) and ingestion of house dust (PFOA only).

Based on these proposed exposure pathways, adult uptake doses estimated for low, medium, and high exposure scenarios were approximately 7, 15, and 30 ng/kg body weight/day, respectively, for PFOS and

5. POTENTIAL FOR HUMAN EXPOSURE

approximately 0.4, 2.5, and 41–47 ng/kg body weight/day, respectively, for PFOA (Trudel et al. 2008). The estimated uptake values were similar for men and women.

Fromme et al. (2009) assessed human exposure to perfluoroalkyls for adults in the general population of western countries. Based on measured in indoor and outdoor air, house dust, drinking water, and dietary PFOS and PFOA levels, the investigators estimated average daily exposure levels of 1.6 ng/kg body weight/day for PFOS and 2.9 ng/kg body weight/day for PFOA. Upper daily exposure levels were determined to be 8.8 ng/kg body weight/day for PFOS and 12.6 ng/kg body weight/day for PFOA. The investigators concluded that the oral route, especially diet, was the primary route of exposure to perfluoroalkyls (Fromme et al. 2007a, 2007b, 2009). The geometric mean adult daily intakes for PFOA and PFOS were estimated as 92.6 and 83.3 ng/day, respectively, for residents in Kansai, Japan and 53.7 and 63.8 ng/day, respectively, for residents in Tohoku, Japan (Harada and Koizumi 2009). The most important exposure pathway for both compounds was food ingestion.

Limited monitoring data are available for PFBA. Monitoring efforts conducted in Washington County, Minnesota near the 3M Cottage Grove Facility revealed widespread contamination of this substance in the groundwater of that area in 2006. This compound has since also been detected along with PFOA, PFOS, PFHxS, and PFBuS in municipal drinking water in Washington County (ATSDR 2008). Chang et al. (2008a) measured concentrations of PFBA in the serum of 127 former employees and 50 current employees of the 3M Cottage Grove Facility in Minnesota. PFBA serum concentrations were below the detection limit in 73.2% of the former employees and 68.0% of the current employees. Only 4% of the serum samples contained PFBA above 2 ng/mL, with maximum concentrations of 6.2 ng/mL for the former employees and 2.2 ng/mL for the current employees. Landsteiner et al. (2014) conducted a biomonitoring study of 196 residents of Washington County, Minnesota for the presence of perfluoroalkyls. The residents of this area were suspected to have been exposed to perfluoroalkyls from drinking water sources. PFOA, PFOS, and PFHxS were detected in all serum samples collected from the 196 residents, while PFBA and PFBuS were detected in 28 and 23% of the samples, respectively. The geometric mean serum concentrations of PFOA, PFOS, and PFHxS were 15.4, 35.9, and 8.4 ng/mL, respectively, which are several times greater than the levels of the U.S. general population when compared to NHANES survey results shown in Tables 5-21 and 5-22. The authors also noted that the geometric mean serum concentrations of these three substances were greater in residents obtaining drinking water from municipal water supplies as compared to residents with private wells.

5. POTENTIAL FOR HUMAN EXPOSURE

Another possible source for perfluoroalkyls in human blood is through uptake of precursor compounds and then conversion of these within the human body (Trudel et al. 2008). For example, Me-PFOA-AcOH and Et-PFOA-AcOH are the oxidation products of 2-(N-methyl-perfluorooctane sulfonamido) ethanol and 2-(N-ethyl-perfluorooctane sulfonamido) ethanol, which were used in surface treatment applications (Calafat et al. 2006a). Concentrations of Me- and Et-PFOA-AcOH measured in human serum may have resulted from exposure of individuals to these perfluoroalkyl sulfonamido ethanols and then conversion of the ethanols to the perfluoroalkyl sulfonamido acetates within the body.

Levels of perfluoroalkyl compounds measured in the blood of occupationally exposed individuals are listed in Table 5-23. 3M estimated doses for various on-site exposure scenarios based on monitoring information collected at the Decatur Facility in Alabama (3M 2008c). Occupational exposure scenarios included groundskeeper/maintenance worker and construction/utility worker exposed to on-site soils, surface water, and sediment. According to 3M, estimated on-site exposure to PFOA ranged from 3.2×10^{-6} to 2.4 ng/kg/day, with the highest estimated exposure corresponding to construction/utility workers engaged in projects involving contact with soil from an on-site field. Individuals who performed jobs that require frequent contact with perfluoroalkyl containing products, such as firefighters, waste handlers, and individuals who install and treat carpets, were also expected to have occupational exposure to these substances (Emmett et al. 2006a). However, Emmett et al. (2006a) determined that levels of PFOA in the serum of these types of individuals were only slightly higher than the non-occupational exposure group (388 ng/mL compared to 329 ng/mL, respectively) while serum levels in workers at a fluoropolymer manufacturing facility were much higher (775 ng/mL).

Table 5-23. Concentrations of PFOA, PFOS, and PFHxS in Human Serum for Occupationally Exposed Individuals

Location	Mean concentration ($\mu\text{g/mL}$ [ppm])			Reference
	PFOA	PFOS	PFHxS	
Decatur, Alabama				
1993 (n=111)	0.00–80.00 (range)	—	—	Olsen et al. 1998b
1995 (n=80)	0.00–114.10 (range)	—	—	Olsen et al. 1998b
1995 (n=90)	—	2.44	—	Olsen et al. 1999
1997 (n=84)	—	1.96	—	Olsen et al. 1999
2000 (n=215)	11.90	1.40	—	Olsen et al. 2003a
1999–2004 (n=26) ^a				Olsen et al. 2007a
Initial	0.691	0.799	0.290	
Final	0.262	0.403	1.85	

5. POTENTIAL FOR HUMAN EXPOSURE

Table 5-23. Concentrations of PFOA, PFOS, and PFHxS in Human Serum for Occupationally Exposed Individuals

Location	Mean concentration ($\mu\text{g/mL}$ [ppm])			Reference
	PFOA	PFOS	PFHxS	
Cottage Grove, Minnesota				
1993 (n=111)	5.0	—	—	Olsen et al. 2000
1995 (n=80)	6.8	—	—	Olsen et al. 2000
1997 (n=74)	6.4	—	—	Olsen et al. 2000
2000 (n=122)	4.63	0.86	—	Olsen and Zobel 2007
Washington Works, Little Hocking, Ohio				
2004–2005				Emmett et al. 2006a
Substantial occupational exposure (n=18)	0.824	—	—	
Antwerp, Belgium				
1995 (n=88)	—	1.93	—	Olsen et al. 1999
1997 (n=65)	—	1.48	—	Olsen et al. 1999
2000 (n=206)	1.03	0.96	—	Olsen et al. 2003a
Mitene, Trissino, Italy				
2007				
Current occupational exposure (n=39)	5.71 ^c (0.20–47.04)	—	—	Costa et al. 2009
Former occupational exposure (n=11)	4.43 ^c (0.53–18.66)	—	—	Costa et al. 2009
2000 (n=25)	18.8	—	—	Costa et al. 2009
2001 (n=42)	19.7	—	—	Costa et al. 2009
2002 (n=46)	19.3	—	—	Costa et al. 2009
2003 (n=41)	13.7	—	—	Costa et al. 2009
2004 (n=34)	11.4	—	—	Costa et al. 2009
2006 (n=49)	10.8	—	—	Costa et al. 2009
2007 (n=50)	11.6	—	—	Costa et al. 2009

5. POTENTIAL FOR HUMAN EXPOSURE

Table 5-23. Concentrations of PFOA, PFOS, and PFHxS in Human Serum for Occupationally Exposed Individuals

Location	Mean concentration ($\mu\text{g/mL}$ [ppm])			Reference
	PFOA	PFOS	PFHxS	
Washington Works				
2004				
Current occupational exposure (n=259)	0.494 (median)	—	—	Sakr et al. 2007b
Intermittent current occupational exposure (n=160)	0.176 (median)	—	—	Sakr et al. 2007b
Past occupational exposure (n=264)	0.195 (median)	—	—	Sakr et al. 2007b
No occupational exposure (n=342)	0.114 (median)	—	—	Sakr et al. 2007b

^aData include results from three retirees from the 3M plant in Cottage Grove, Minnesota.

“—” indicates no available data; PFHxS = perfluorohexane sulfonic acid; PFOA = perfluorooctanoic acid; PFOS = perfluorooctane sulfonic acid

Fu et al. (2014b) analyzed the effects of sex and age on levels of perfluoroalkyl compounds in a study of 133 (79 male, 54 female) participants. In general, higher levels of PFOA, PFOS, PFNA, and PFDeA were observed in male subjects; however, differences were only statistically significant for PFOA and PFDeA. Sex differences in other perfluoroalkyl compounds were not observed. For both male and female subjects, increasing levels of PFOA, PFNA, and PFOS were positively correlated with increasing age. Data from the 2005–2012 NHANES survey were used to derive a regression-based model to estimate serum levels of total perfluoroalkyl residues in the human population using only age, sex, and PFOA and PFOS levels (Jain 2015). Although the data used in the regression-based model were derived from the U.S. population, the author expected that the data could be used to estimate exposures to populations elsewhere in the world as well.

Christensen et al. (2016) conducted a biomonitoring study of perfluoroalkyls on male fishermen from Wisconsin ≥ 50 years old with a history of sport fish consumption. Increasing age and lower BMI were generally associated with higher levels of the perfluoroalkyls; however, there were only weak correlations observed between amounts of fish consumption and perfluoroalkyl levels, with the exception of PFDeA. Levels of PFOA, PFNA, and PFHxS in the blood of the male anglers were similar to the levels for a subset of the NHANES 2011–2012 survey (non-Hispanic white males ≥ 50 years old); however, levels of PFOS and PFDeA were approximately 2 times greater in the anglers as compared to the NHANES survey subgroup. The median and 95th percentile concentrations of PFOS in the anglers were 19.00 and

5. POTENTIAL FOR HUMAN EXPOSURE

54.00 ng/mL, respectively, as compared to 10.33 and 25.83 ng/mL, respectively, in the NHANES study group. The median and 95th percentile concentrations of PFDeA in the anglers were 0.52 and 1.90 ng/mL, respectively, as compared to 0.23 and 0.53 ng/mL in the NHANES study group.

Perfluoroalkyl compounds have been detected in childhood serum samples, human breast milk, and umbilical cord blood; reported concentrations are listed in Tables 5-24 and 5-25. Measurements of perfluoroalkyl compounds in amniotic fluid, meconium, neonatal blood, or other tissues have not been located.

Table 5-24. Percent Detection and Levels of PFOA and PFOS in Children's Serum, Umbilical Cord Blood, and Breast Milk

Location	Detection and concentration (ng/mL [ppb]) ^a		Reference
	PFOA	PFOS	
Serum			
U.S. adolescents—NHANES (ages 12–19)			
1999–2000 (n=543)			Calafat et al. 2007a
Percent >LOD	100%	100%	
LOD	0.1	0.2	
Geometric mean	5.5	29.1	
95th percentile	11.2	56.8	
2003–2004 (n=640)			Calafat et al. 2007b
Percent >LOD	99.7% ^b	99.9% ^b	
LOD	0.1	0.4	
Geometric mean	3.9	19.3	
95th percentile	8.6	42.2	
2005–2006 (n=640)			CDC 2018
Percent >LOD	NR	NR	
LOD	0.1	0.2	
Geometric mean	3.59	15.0	
95th percentile	8.40	38.5	
2007–2009 (n=357)			CDC 2018
Percent >LOD	NR	NR	
LOD	0.1	0.2	
Geometric mean	3.91	11.3	
95th percentile	7.30	28.0	

5. POTENTIAL FOR HUMAN EXPOSURE

Table 5-24. Percent Detection and Levels of PFOA and PFOS in Children's Serum, Umbilical Cord Blood, and Breast Milk

Location	Detection and concentration (ng/mL [ppb]) ^a		Reference
	PFOA	PFOS	
2009–2010 (n=364)			CDC 2013
Percent >LOD	NR	NR	
LOD	0.1	0.2	
Geometric mean	2.74	6.84	
95th percentile	5.00	18.1	
2011–2012 (n=344)			CDC 2018
Percent >LOD	NR	NR	
LOD	0.1	0.2	
Geometric mean	1.80	4.16	
95th percentile	3.59	10.8	
2013–2014 (n=401)			CDC 2018
Percent >LOD	NR	NR	
LOD	0.1	0.2	
Geometric mean	1.66	3.54	
95th percentile	3.47	9.30	
U.S. children—NHANES 2013-2014			
Ages 3-5 (n=181)			
Percent >LOD	100%	100%	Ye et al. 2018a; CDC 2018
LOD	0.1	0.1	
Geometric mean	2.00	3.38	
95th percentile	5.58	8.82	
Ages 6-11 (n=458)			
Percent >LOD	100%	100%	Ye et al. 2018a; CDC 2018
LOD	0.1	0.1	
Geometric mean	1.89	4.15	
95th percentile	3.84	12.4	
U.S. girls (ages 6–8)			
Cincinnati, Ohio (n=353)			
Percent >LOD ^c	99.7%	99.7%	Pinney et al. 2014
Geometric mean	7.8	13.2	
Median	7.3	13.6	
U.S. girls (ages 6–8)			
San Francisco, California (n=351)			
Percent >LOD ^c	100%	100%	Pinney et al. 2014
Geometric mean	5.7	13.2	
Median	5.8	12.5	

5. POTENTIAL FOR HUMAN EXPOSURE

Table 5-24. Percent Detection and Levels of PFOA and PFOS in Children's Serum, Umbilical Cord Blood, and Breast Milk

Location	Detection and concentration (ng/mL [ppb]) ^a		Reference
	PFOA	PFOS	
U.S. children (ages 2–12)			
1994–1995 (n=598)			Olsen et al. 2004b
Percent >LLOQ ^c	96%	100%	
Geometric mean	4.9	37.5	
95th percentile ^d	10	89	
U.S. children (West Virginia and Ohio; ages 1–19)			Mondal et al. 2012
2005–2006 (n=4,943)			
Geometric mean	31.2	19.2	
90th percentile	201	36.8	
U.S. children NHANES 2001–2002 (ages 6–11)			Kato et al. 2009b
2001–2002 (n=936)			
Least square mean	6.1–7.6	30.45–42.45	
Umbilical cord blood			
San Francisco, California			Morello-Frosch et al. 2016
Percent >LOD ^c	56%	100%	
Geometric mean	–	2.27	
95th percentile	1.68	4.35	
Baltimore THREE Study			Apelberg et al. 2007a, 2007b
Cord serum (n=299)			
Percent >LOD	100%	99%	
LOD	0.1–0.2	0.2	
Geometric mean	1.6	4.9	
Minimum	0.3	<0.2	
Maximum	7.1	34.8	
Maternal serum (n=293)			
Median	1.4–1.6	4.1–5.0	
Germany			Midasch et al. 2007
Cord plasma (n=11)			
Percent detected	100%	100%	
LOQ	0.5	0.5	
Median	3.4	7.3	

5. POTENTIAL FOR HUMAN EXPOSURE

Table 5-24. Percent Detection and Levels of PFOA and PFOS in Children's Serum, Umbilical Cord Blood, and Breast Milk

Location	Detection and concentration (ng/mL [ppb]) ^a		Reference
	PFOA	PFOS	
Maternal plasma (n=11)			
Percent detected	100%	100%	
LOQ	0.5	0.5	
Median	2.6	13.0	
Danish National Birth Cohort			Fei et al. 2007
Cord blood (n=50)			
Percent >LLOQ	98%	100%	
LLOQ	1.0	1.0	
Mean	3.7	11.0	
Maternal blood (n=200)			
Percent >LLOQ	98%	100%	
LLOQ	1.0	1.0	
Mean	4.5	29.9	
Japan			Inoue et al. 2004
Cord serum (n=15)			
Percent >LOD	0%	100%	
LOD	0.5	0.5	
Range		1.6–5.3	
Maternal serum (n=15)			
Percent >LOD	20%	100%	
LOD	0.5	0.5	
Range	0.5–2.3	4.9–17.6	
Breast milk			
Massachusetts (n=45)			Tao et al. 2008
Milk			
Percent >LOQ ^c	89%	96%	
Median	0.0361	0.106	
Minimum	<0.0301	<0.032	
Maximum	0.161	0.617	
Sweden (n=12)			Kärrman et al. 2007
Milk			
Percent >LOD	8% ^d	100%	
LOD	0.01	0.005	
Mean	–	0.201	
Range	<0.209–0.492	0.060–0.470	

5. POTENTIAL FOR HUMAN EXPOSURE

Table 5-24. Percent Detection and Levels of PFOA and PFOS in Children's Serum, Umbilical Cord Blood, and Breast Milk

Location	Detection and concentration (ng/mL [ppb]) ^a		Reference
	PFOA	PFOS	
Maternal serum			
Percent >LOD	100%	100%	
LOD	0.01	0.005	
Mean	3.8	20.7	
Range	2.4–5.3	8.2–48.0	
China (n=19)			So et al. 2006b
Percent >LOD	100%	100%	
LOD	0.021–0.027	0.001–0.0036	
Range	0.047–0.210	0.045–0.360	
Germany/Hungary (n=70)			Völkel et al. 2008
Percent >LOQ	16%	100%	
Minimum	<0.200	0.028	
Maximum	0.460	0.639	

^a"Less than" values indicate that the concentration was reported as below the LOD or LLOQ. For cases where samples had concentrations below the LOD or LLOQ, a value between zero and the LOD or LLOQ was assigned when calculating the mean concentration.

^bPercent detection for the adolescent age group was not specified for the 2003–2004 NHANES samples. Percentages listed here are for the total sample population.

^cLOD or LLOQ not reported.

^dReported as bias-corrected estimates.

"—" indicates no available data; LLOQ = lower limit of quantification; LOD = limit of detection; LOQ = limit of quantification; NR = not reported; PFOA = perfluorooctanoic acid; PFOS = perfluorooctane sulfonic acid

5. POTENTIAL FOR HUMAN EXPOSURE

Table 5-25. Percent Detection and Levels of Other Perfluoroalkyls in Children's Serum, Umbilical Cord Blood, and Breast Milk

Sample population	Detection and concentration (ng/mL [ppb]) ^a									
	PFHpA	PFNA	PFDeA	PFUA	PFDoA	PFBuS	PFHxS	PFOSA	Me-PFOSA-AcOH	Et-PFOSA-AcOH
Serum										
U.S. NHANES (ages 12–19)										
1999–2000 (n=543) (Calafat et al. 2007a)										
Percent >LOD	10% ^b	96%	15%	12% ^b	<1% ^b	—	100%	100%	100%	98%
Geometric mean	—	0.5	<0.2	—	—	—	2.7	0.4	1.3	0.8
95th percentile	—	1.1	0.5	—	—	—	12.9	1.5	3.7	2.4
2003–2004 (n=640) (Calafat et al. 2007b)										
Percent >LOD	6.2% ^b	98.8% ^b	31.3% ^b	9.7% ^b	<0.1% ^b	<0.4% ^b	98.3% ^a	22.2% ^b	27.5% ^b	3.4% ^b
Geometric mean	<0.3	0.9	<0.3	<0.3	<1.0	<0.4	2.4	<0.2	<0.6	<0.4
95th percentile	0.5	2.7	0.7	<0.3	<1.0	<0.4	13.1	0.3	1.4	<0.4
2005–2006 (n=640) (CDC 2018)										
Percent >LOD	NR	NR	NR	NR	NR	NR	NR	NR	NR	NR
Geometric mean	—	0.929	0.295	—	—	—	2.09	—	0.432	—
95th percentile	1.10	2.70	0.800	0.500	<LOD	0.100	14.1	0.300	1.48	0.200
2007–2008 (n=357) (CDC 2018)										
Percent >LOD	NR	NR	NR	NR	NR	NR	NR	NR	NR	NR
Geometric mean	—	1.16	0.231	—	—	—	2.40	—	0.340	—
95th percentile	0.600	2.54	0.800	0.300	<LOD	<LOD	15.9	0.300	1.60	<LOD
2009–2010 (n=364) (CDC 2018)										
Percent >LOD	NR	NR	NR	NR	NR	NR	NR	NR	NR	NR
Geometric mean	—	1.10	0.220	—	—	—	2.03	—	0.235	—
95th percentile	0.400	2.62	0.600	0.400	<LOD	<LOD	12.3	<LOD	0.900	<LOD
2011–2012 (n=344) (CDC 2018)										
Percent >LOD	NR	NR	NR	NR	NR	NR	NR	NR	NR	NR
Geometric mean	—	0.741	0.146	—	—	—	1.28	—	0.134	—

5. POTENTIAL FOR HUMAN EXPOSURE

Table 5-25. Percent Detection and Levels of Other Perfluoroalkyls in Children's Serum, Umbilical Cord Blood, and Breast Milk

Sample population	Detection and concentration (ng/mL [ppb]) ^a									
	PFHpA	PFNA	PFDeA	PFUA	PFDoA	PFBuS	PFHxS	PFOSA	Me-PFOSA-AcOH	Et-PFOSA-AcOH
95th percentile	0.190	2.06	0.360	0.250	<LOD	<LOD	6.45	<LOD	0.510	<LOD
2013–2014 (n=402) (CDC 2018)										
Percent >LOD	NR	NR	NR	NR	NR	NR	NR	NR	NR	NR
Geometric mean	—	0.599	0.136	—	—	—	1.27	—	—	NR
95th percentile	0.200	2.00	0.400	0.200	0.200	<LOD	6.30	<LOD	0.600	NR
2013-2014										
Ages 3–5 (n=181) (Ye et al. 2018a, 2018b; CDC 2018)										
Percent >LOD	27%	100%	50%	27%	0%	1%	100%	7%	51%	4%
LOD	0.1	0.1	0.1	0.1	0.1	0.1	0.1	0.1	0.1	0.1
Geometric mean	<LOD	0.764	<LOD	<LOD	<LOD	<LOD	0.715	<LOD	<LOD	<LOD
95th percentile	0.310	3.49	0.370	0.370	<LOD	<LOD	1.62	0.110	1.02	<LOD
Ages 6–11 (n=458) (Ye et al. 2018a, 2018b; CDC 2018)										
Percent >LOD	15%	100%	46%	28%	0%	7%	100%	2%	54%	3%
LOD	0.1	0.1	0.1	0.1	0.1	0.1	0.1	0.1	0.1	0.1
Geometric mean	<LOD	0.809	<LOD	<LOD	<LOD	<LOD	0.913	<LOD	<LOD	<LOD
95th percentile	0.170	3.19	0.350	0.250	<LOD	0.130	4.14	<LOD	0.940	<LOD

5. POTENTIAL FOR HUMAN EXPOSURE

Table 5-25. Percent Detection and Levels of Other Perfluoroalkyls in Children's Serum, Umbilical Cord Blood, and Breast Milk

Sample population	Detection and concentration (ng/mL [ppb]) ^a									
	PFHpA	PFNA	PFDeA	PFUA	PFDoA	PFBuS	PFHxS	PFOSA	Me-PFOSA-AcOH	Et-PFOSA-AcOH
U.S. children (ages 2–12)										
1994–1995 (n=598) (Olsen et al. 2004b)										
Percent >LLOQ	—	—	—	—	—	—	78%	14%	67%	81%
LLOQ							NR	1.0	NR	NR
Geometric mean	—	—	—	—	—	—	4.5	<2.0	1.9	3.3
95th percentile ^b	—	—	—	—	—	—	65	<2.0	12	10
U.S. girls (ages 6–8)										
Cincinnati, Ohio (Pinney et al. 2014)										
Percent >LOD ^c	—	99.9	75.8	—	—	—	99.7	19	94.9	14.4%
Geometric mean	—	1.4	0.3	—	—	—	5.1	<LOD	0.7	<LOD
Median	—	1.4	0.3	—	—	—	5.2	<LOD	0.7	<LOD
U.S. girls (ages 6–8)										
San Francisco, California (Pinney et al. 2014)										
Percent >LOD ^c	—	100	78.7	—	—	—	100	10	96.3	14.8
Geometric mean	—	1.7	0.3	—	—	—	3.0	<LOD	0.7	<LOD
Median	—	1.6	0.3	—	—	—	2.3	<LOD	0.6	<LOD
Umbilical cord blood										
San Francisco, California (Morello-Frosch et al. 2016) (n=65)										
Percent >LOD ^c	56%	97%	9%	84%	0%	25%	—	91%	95%	63%
Geometric mean	—	0.29	—	0.03	—	—	—	0.02	0.07	0.02
95th percentile	0.23	0.93	0.49	0.16	—	0.03	—	0.10	0.38	0.05
Baltimore THREE Study (Apelberg et al. 2007a, 2007b)										
Cord serum (n=299)										
Percent >LOD	2%	—	24%	34%	5%	3%	—	26%	40%	1%
LOD	0.4	—	0.2	0.2	0.2	0.1	—	0.05	0.2	0.2
Minimum	<0.4	—	<0.2	<0.2	<0.2	<0.1	—	<0.05	<0.2	<0.2
Maximum	2.6	—	1.1	1.9	1.7	0.2	—	0.8	1.8	0.5

5. POTENTIAL FOR HUMAN EXPOSURE

Table 5-25. Percent Detection and Levels of Other Perfluoroalkyls in Children's Serum, Umbilical Cord Blood, and Breast Milk

Sample population	Detection and concentration (ng/mL [ppb]) ^a								Me-PFOSA-AcOH	Et-PFOSA-AcOH
	PFHpA	PFNA	PFDeA	PFUA	PFDoA	PFBuS	PFHxS	PFOSA		
Japan (Inoue et al. 2004)										
Cord serum (n=15)										
Percent >LOD	—	—	—	—	—	—	—	0%	—	—
LOD								1.0		
Maternal serum (n=15)										
Percent >LOD	—	—	—	—	—	—	—	0%	—	—
LOD								1.0		
Breast milk										
Massachusetts (n=45) (Tao et al. 2008b)										
Milk										
Percent >LOQ ^c	<1%	64%	<1%	<1%	<1%	<1%	51%	—	—	—
Minimum	<0.010	<0.0052	<0.00772	<0.00499	<0.00440	<0.0100	<0.0120	—	—	—
Maximum	0.0234	0.0184	0.0111	0.00884	0.00974	0.0198	63.8	—	—	—
Sweden (n=12) (Kärman et al. 2007a)										
Milk										
Percent >LOD	—	17%	0%	0%	—	—	100%	67%	—	—
LOD		0.005	0.008	0.005			0.01	0.007		
Mean	—	0.017			—	—	0.085	0.013	—	—
Range	—	<0.005– 0.020			—	—	0.031– 0.172	<0.007– 0.030	—	—
Maternal serum										
Percent >LOD	—	100%	100%	100%	—	—	100%	75%	—	—
LOD		0.005	0.008	0.005			0.01	0.007	—	—
Mean		0.80	0.53	0.40			4.7	0.24		
Range	—	0.43– 2.5	0.27–1.8	0.20–1.5	—	—	1.8– 11.8	0.16– 0.19	—	—

5. POTENTIAL FOR HUMAN EXPOSURE

Table 5-25. Percent Detection and Levels of Other Perfluoroalkyls in Children's Serum, Umbilical Cord Blood, and Breast Milk

Sample population	Detection and concentration (ng/mL [ppb]) ^a									
	PFHpA	PFNA	PFDeA	PFUA	PFDoA	PFBuS	PFHxS	PFOSA	Me-PFOSA-AcOH	Et-PFOSA-AcOH
China (n=19) (So et al. 2006b)										
Percent >LOD	37%	100%	100%	100%	—	11%	100%	—	—	—
LOD	0.005–0.010	0.001–0.010	0.0011–0.0025	0.0022–0.0050	—	0.001–0.005	0.001–0.010	—	—	—
Range	<0.005–0.0067	0.01–0.062	0.0038–0.011	0.0091–0.056	—	<0.001–0.0025	0.004–0.10	—	—	—

^a"Less than" values indicate that the concentration was reported as below the LOD or LLOQ. For cases where samples had concentrations below the LOD or LLOQ, a value between zero and the LOD or LLOQ was assigned when calculating the mean concentration.

^bPercent detection for the adolescent age group was not specified for these samples. Percentages listed here are for the total sample population.

^cLOD or LLOQ not reported.

“—” indicates no available data; Et-PFOSA-AcOH = 2-(N-ethyl-perfluorooctane sulfonamide) acetic acid; LLOQ = lower limit of quantification; LOD = limit of detection; Me-PFOSA-AcOH = 2-(N-methyl-perfluorooctane sulfonamide) acetic acid; ND = no data; NR = not reported; PFBuS = perfluorobutane sulfonic acid; PFDeA = perfluorodecanoic acid; PFDoA = perfluorododecanoic acid; PFHpA = perfluoroheptanoic acid; PFHxS = perfluorohexane sulfonic acid; PFNA = perfluorononanoic acid; PFOSA = perfluorooctane sulfonamide; PFUA = perfluoroundecanoic acid

A few studies are available that reported serum levels of perfluoroalkyls measured in children. Calafat et al. (2007a, 2007b) reported perfluoroalkyl serum concentrations measured in 543–640 adolescents who made up the 12–19-year-old age subpopulation in the 1999–2000 and 2003–2004 NHANES surveys. Olsen et al. (2003a) measured PFOA, PFOS, PFHxS, PFOSA, Me-PFOSA-AcOH, and Et-PFOSA-AcOH in the serum of 598 children of ages 2–12 years from various locations in the United States who were diagnosed with group A streptococcal infections. Mean serum concentrations of perfluoroalkyl compounds measured in children from these studies are similar to mean concentrations reported for adults (Calafat et al. 2007a, 2007b; Olsen et al. 2003a). For example, geometric mean concentrations of PFOA and PFOS measured during the NHANES surveys were 3.9–5.5 and 19.3–29.1 ng/mL, respectively, in adolescent serum and 3.9–5.2 and 20.7–30.4 ng/mL, respectively, in serum of the total population. Emmett et al. (2006a) found that 2–5-year-old children had a higher serum PFOA (median 600 ng/mL) in the Little Hocking Water Association district compared with residents in all other age groups (median 321 ng/mL) except for the group aged >60 years, whose levels were similar to those in young children. Several factors may have contributed to the observed high levels in children: infants and young children

5. POTENTIAL FOR HUMAN EXPOSURE

proportionally drink more water per kg of body weight than adults; children (and also the elderly) tend to spend more time at home with exclusive use of residential water than other age groups; and trans-placental and breast milk exposures could also contribute to levels in children.

Kato et al. (2009b) reported serum levels in children aged 3–5 and 6–11 years from the 2001–2002 NHANES survey for PFNA, PFOA, PFOS, and PFOSA. The highest levels were typically observed for PFOS. The least square mean (LSM is equivalent to arithmetic mean) serum concentrations for PFOS ranged from 30.45 ng/mL for Mexican Americans to 42.45 ng/mL for non-Hispanic whites aged 6–11 years (Kato et al. 2009b). The LSM for PFOA ranged from 6.1 ng/mL for Mexican Americans to 7.6 ng/mL for non-Hispanic whites aged 6–11 years. Among 3–5 year olds, specific data from pooled samples were only presented for PFNA. The LSM serum PFNA serum concentrations for this age group were 0.9, 1.2, and 0.6 ng/mL for non-Hispanic whites, non-Hispanic blacks, and Mexican Americans, respectively (Kato et al. 2009b).

Blood serum levels of PFOA, PFOS, and PFHxS obtained in 2006–2007 from children residing in Australia were reported by Toms et al. (2009). The highest levels tended to occur for PFOS. Mean PFOS serum levels (combined male and female) ranged from 7.0 ng/mL for infants 0–0.5 years of age to 18.3 ng/mL for 6–9 year olds, while mean PFOA serum levels ranged from 4.5 ng/mL for infants 0–0.5 years of age to 8.2 ng/mL for 6–9 year olds. Mean serum PFHxS levels ranged from 0.9 ng/mL for infants 0–0.5 years of age to 5.8 ng/mL for 6–9 year olds (Toms et al. 2009).

Although mean serum concentrations of perfluoroalkyl compounds are reported to be similar for older children (12–19 years of age) and adults, estimated 95th percentile values of PFHxS measured in childhood serum were noted to be higher than values estimated for adults. Olsen et al. (2003a) reported bias-corrected 95th percentile estimates of 65 ng/mL for PFHxS in the serum of children ages 2–12 years. This value is higher than bias-corrected 95th percentile estimates of 9.5 and 8.3 ng/mL based on PFHxS measurements in the serum of 645 U.S. adult blood donors and 238 elderly individuals from the Seattle, Washington area, respectively (Olsen et al. 2003b, 2004b, 2004c). The difference is less extreme in the NHANES data, with PFHxS 95th percentile values of 12.9–13.1 ng/mL reported for children compared to values of 8.3–8.7 ng/mL reported for the total population. Olsen et al. (2004b) also noted statistically higher levels of Me-PFOSA-AcOH measured in children citing estimated 95th percentile values of 12.0, 5.0, and 3.8 ng/mL for serum concentrations of this substance measured in children, adult donors, and elderly individuals, respectively (Olsen et al. 2003b, 2004b, 2004c).

5. POTENTIAL FOR HUMAN EXPOSURE

Reasons for the observed differences of PFHxS and Me-PFOSA-AcOH levels in childhood serum samples compared to adult samples have not been determined. Olsen et al. (2004b) stated that different exposure and activity patterns between children and adults should be considered. For example, children may have a higher exposure than adults to PFHxS, a substance that has been used in carpet treatment applications, since they are lower to the ground and have increased contact with carpeted floors (Calafat et al. 2007a; Olsen et al. 2004b).

When estimating PFOS and PFOA uptake doses for children, Trudel et al. (2008) assumed the same exposure pathways for children as were proposed for adults, but considered exposure from hand-to-mouth transfer from treated carpets to be much larger in children. This pathway was estimated to contribute 40–60% of the total uptake of both PFOS and PFOA in infants (0–1 years), toddlers (1–4 years), and children (5–11 years) in the high-exposure scenario. Exposure via human breast milk was included in the food consumption pathway for infants. Exposure via mouthing of clothes, carpet, and upholstery was also considered for children <12 years old; however, this was considered to be a minor pathway of exposure. PFOS uptake doses estimated for the low-, medium-, and high-exposure scenarios were 18.1–219 ng/kg body weight/day for infants, 14.8–201 ng/kg body weight/day for toddlers, and 9.7–101 ng/kg body weight/day for children. PFOA uptake doses estimated for the low-, medium-, and high-exposure scenarios were 2.2–121 ng/kg body weight/day for infants, 1.2–128 ng/kg body weight/day for toddlers, and 0.8–65.2 ng/kg body weight/day for children. In contrast to the estimates for children under age 12, relative exposure pathways and uptake doses estimated for teenagers (12–20 years old) were approximately the same as for adults.

Tao et al. (2008b) measured perfluoroalkyl concentrations in 45 human breast milk samples collected from Massachusetts. PFOS, PFOA, PFHxS, and PFNA were each detected in 96, 89, 51, and 64% of the samples, respectively, with median concentrations of 106, 36.1, 12.1, and 6.97 pg/mL, respectively. PFHpA, PFDeA, PFUA, PFDoA, and PFBuS were each detected in <1% of the samples. Perfluoroalkyls have also been measured in the human breast milk of individuals from Sweden, China, and Germany/Hungary (Kärman et al. 2007; So et al. 2006b; Völkel et al. 2008). PFOS was detected in all samples, while detection of PFOA ranged from 8 to 100% in these studies. The reported maximum concentrations of PFOS and PFOA measured in human breast milk samples collected during these studies were 0.360–0.639 and 0.210–0.490 ng/mL, respectively (Kärman et al. 2007; So et al. 2006b; Völkel et al. 2008). Other perfluoroalkyls detected in human breast milk included PFHpA, PFNA, PFDeA, PFUA, PFBuS, PFHxS, and PFOSA. Maximum concentrations of these compounds were reported to be <0.18 ng/mL (Kärman et al. 2007).

5. POTENTIAL FOR HUMAN EXPOSURE

The presence of perfluoroalkyl compounds in umbilical cord blood indicates that these substances can cross the placental barrier resulting in the exposure of babies *in utero* (Apelberg et al. 2007a, 2007b; Fei et al. 2007; Inoue et al. 2004; Midasch et al. 2007). In most studies, PFOS and PFOA have been detected in 99–100% of umbilical cord blood samples with reported concentrations were 4.9–11.0 and 1.6–3.7 ng/mL, respectively (Apelberg et al. 2007a, 2007b; Fei et al. 2007; Inoue et al. 2004; Midasch et al. 2007; Morello-Frosch et al. 2016). Inoue et al. (2004) did not detect PFOA in 15 cord blood samples from Japan; however, this compound was only detected in the maternal serum of three mothers. Apelberg et al. (2007a) also reported concentrations of other perfluoroalkyl compounds measured in 299 cord serum samples collected during the Baltimore THREE Study. Of these compounds, PFDeA, PFUA, PFOSA, and Me-PFOSA-AcOH were detected most frequently (24, 34, 26, and 40%, respectively). Maximum concentrations in these samples ranged from 1.1 to 1.9 ng/mL. PFHpA, PFDoA, PFBuS, and Et-PFOSA-AcOH were each detected in <6% of the samples, with maximum concentrations ranging from 0.2 to 2.6 ng/mL. Manzano-Salgado et al. (2015) studied the potential transfer of perfluoroalkyls from mothers to their children during pregnancy. Maternal blood and cord serum were collected from 66 mother-child pairs and analyzed for the presence of perfluoroalkyls. A positive correlation was found between maternal plasma and maternal serum with cord serum levels, and the authors concluded that either maternal plasma or maternal serum could be used as a method to estimate fetal exposure to perfluoroalkyls. Median concentrations of PFOS and PFOA were 6.18 and 2.85 ng/mL, respectively, in maternal plasma and 6.99 and 2.97 ng/mL, respectively, in maternal serum. PFOS and PFOA levels in cord serum were 1.86 and 1.90 ng/mL, respectively. A biomonitoring survey of 1,533 pregnant females in Denmark from 2008 to 2013 showed decreasing levels of most perfluoroalkyls in the females' blood during this time period (Bjerregaard-Olesen et al. 2016). The results of this study showed that serum levels of PFHxS, PFOS, PFOA, PFNA, and PFDeA decreased at a rate of 7.0, 9.3, 9.1, 6.2, and 6.3 per year, respectively. Morello-Frosch et al. (2016) measured the levels of perfluoroalkyls in 77 maternal and 65 paired umbilical cord blood samples from pregnant females and newborn children in San Francisco, California. Perfluoroalkyls, including PFOA and PFOS, were widely detected; however, concentrations in cord blood or serum were typically equal to or lower than maternal blood levels.

5.7 POPULATIONS WITH POTENTIALLY HIGH EXPOSURES

Potentially high exposures to perfluoroalkyls can occur in the following population categories: perfluoroalkyl production and manufacturing workers, communities located near fluorochemical facilities, and individuals with prolonged use of perfluoroalkyl-containing products. These populations

5. POTENTIAL FOR HUMAN EXPOSURE

may have higher exposure to perfluoroalkyl compounds than the general population based on elevated concentrations of these substances measured in air, soil, sediment, surface water, groundwater, and vegetation surrounding these facilities (3M 2007b, 2008b, 2008c; Barton et al. 2006; Davis et al. 2007; Olsen 2015).

A number of studies have evaluated serum perfluoroalkyl levels in former workers at 3M and DuPont PFOA and/or PFOS facilities in the United States. At the 3M Cottage Grove facility, the geometric mean serum PFOA level was 5,200 ng/mL in PFOA production workers and the PFOS level was 1,760 ng/mL in PFOS production workers in 2000 (Olsen 2015). At another 3M facility in Decatur, geometric mean serum PFOA, PFOS, and PFHxS levels were 910, 1,130, and 180 ng/mL, respectively (Olsen 2015). The estimated mean serum PFOA level at DuPont's Washington Works facility was 2,050 ng/mL for all workers (Woskie et al. 2012)

Family members of occupationally exposed workers have been shown to have higher exposure to perfluoroalkyls via dust transfer as compared to family members of nonoccupationally exposed workers (Fu et al. 2015). PFOA, PFOS, PFBA, PFBuS, PFNA, and PFHxS have been detected in the municipal drinking water and private wells of some communities located near fluorochemical facilities (3M 2008c; ATSDR 2008; Emmett et al. 2006a; Hoffman et al. 2011; Hölzer et al. 2008; Post et al. 2013; Steenland et al. 2009a; Wilhelm et al. 2009). Emmett et al. (2006a) compared PFOA serum levels to various types of exposure for individuals living in the Little Hocking community (near DuPont's Washington Works facility) and concluded that residential water source was the primary determinant of serum PFOA at this location. These authors reported that the mean human serum PFOA level was 105 times higher than the residential drinking water level. In residents with residential drinking water but without occupational exposure, the model of best-fit for serum PFOA also varied significantly by age (highest in children ≤ 5 years old and adults >60 years old), use of carbon home water filters (negative effect), number of servings of home-grown fruits and vegetables (positive effect), and number of tap water-based drinks per day (positive effect). Median PFOA serum levels for residents currently residing in six water districts located in the mid-Ohio Valley near the Washington Works facility ranged from 12.1 to 224.1 ng/mL, while the median concentration ranged from 10.5 to 33.7 ng/mL for residents who previously worked or resided in these districts (Steenland et al. 2009a). PFOA serum levels tended to be highest for children aged 0–9 years and persons >50 years old. These authors also reported that former employees at the chemical plant had much higher levels (median=75 ng/mL) than people who had not worked at the plant (median=24 ng/mL), but lower levels than those who continued to be employed at the plant during the monitoring period (median=148 ng/mL). The serum levels of the 69,030 residents participating in this

5. POTENTIAL FOR HUMAN EXPOSURE

study categorized by age are provided in Table 5-26. Additional blood serum levels of PFOA and PFOS for residents in selected areas of Ohio, West Virginia, New Jersey, and Minnesota whose residential source of drinking water may have been contaminated are available from the EPA docket on PFOA and related perfluoroalkyls (EPA-HQ-OPPT-2003-0012) (Bilott 2004, 2005a, 2005b, 2007).

Table 5-26. Blood Serum Levels for 69,030 Current and Former Residents of Six Water Districts in the Mid-Ohio Valley (2005–2006)

Age (years)	Number (percentage of total)	Median perfluorooctanoic acid (PFOA) level (ng/mL)
0–9	4,915 (7.1)	32.8
10–19	9,658 (14.0)	26.6
20–29	10,073 (14.6)	21.0
30–39	10,547 (15.3)	22.7
40–49	12,113 (17.6)	28.0
50–59	10,515 (15.2)	33.6
60–69	6,881 (10)	42.9
≥70	4,328 (6.3)	40.1

Source: Steenland et al. 2009a

ATSDR performed an exposure investigation for residents of Decatur, Alabama following an accidental release of perfluoroalkyls into the Decatur waste water treatment plant (ATSDR 2013). A group of 155 residents had their blood tested for levels of eight perfluoroalkyls. Serum levels of five of the substances were lower or similar to levels of the general population when compared to the NHANES results. Residents who used the West Morgan/East Lawrence public water supply had significantly higher geometric mean serum levels of two substances (PFOA and PFHxS) as compared to the geometric mean for a similar demographic group from the NHANES survey. Serum levels in the residents for all eight compounds were shown to be much lower than levels found in occupationally exposed individuals who regularly worked with these substances (ATSDR 2013).

Residents of Arnsberg, Germany who were exposed to perfluoroalkyls from contaminated drinking water had serum PFOA levels that were 4.5–8.3 times greater than those from a non-exposed reference population depending upon the age and sex of the groups (Hölzer et al. 2008).

Shin et al. (2011) provided PFOA exposure data on 45,276 non-occupationally exposed individuals residing in eastern Ohio and West Virginia who were exposed to PFOA via drinking water. The median serum concentration for all subjects was 24.3 ng/mL (ppb) measured in 2005–2006. This was about

5. POTENTIAL FOR HUMAN EXPOSURE

6 times greater than the median concentration (3.20 ng/mL) of 2,120 residents of the general population taken from the NHANES data for 2005–2006 (CDC 2018).

Individuals involved in activities with prolonged use of perfluoroalkyl-containing products, such as the application of protective coatings for fabrics and carpet and the use of paper coatings or ski wax, may have higher levels of exposure to perfluoroalkyl compounds than the general population (Calafat et al. 2006a; Olsen 2015). Elevated serum levels of PFOA, PFNA, PFHxA, PFHpA, PFDeA, and PFUA have been found in professional ski waxers using products containing fluorotelomers; the perfluoroalkyls were likely formed via fluorotelomer metabolism (Olsen 2015). Some firefighting foams contain perfluoroalkyls, and firefighters who use these products have been shown to have greater exposures as compared to the general population. Dobraca et al. (2015) compared perfluoroalkyl serum levels of a group of firefighters in California to an adult population from the NHANES survey. Levels of PFOA and PFOS were only slightly higher in the firefighter group (geometric means 3.75 and 12.50 ng/mL, respectively) when compared to adult males in the 2009–2010 NHANES general population survey (3.61 and 12.13 ng/mL, respectively); however, PFDeA serum concentrations of firefighters were up to 3 times greater than the NHANES comparison group for the 25th–95th percentiles (50th percentile in firefighters; 0.72 ng/mL compared to 0.30 ng/mL) and the geometric mean (0.90 ng/mL compared to 0.30 ng/mL). In a small-scale study of 37 firefighters participating in the C8 Health Project, significantly (adjusted for age, water district, household income, and smoking) higher levels of PFOA and PFHxS were found in the firefighters compared to 5,373 male participants with other jobs (Jin et al. 2011). Geometric mean PFOA and PFHxS levels were 37.59 and 4.77 ng/mL, respectively, in the firefighters and 31.59 and 3.62 ng/mL, respectively, in the other participants. No significant differences in PFOS or PFNA levels were found between the groups. A biomonitoring study of 149 firefighters in Australia showed that 100% of serum samples collected had detectable levels of PFOA, PFOS, PFHxS, and PFNA (Rotander et al. 2015). Serum levels of PFHxS were found to be approximately 10–15 times higher than levels found in the general population of Australia and Canada, while PFOS levels in the firefighters were approximately 6–10 times greater than the general population of these nations.

3M estimated doses for various off-site exposure scenarios based on monitoring information collected at the Decatur Facility in Alabama (3M 2008c). Exposure scenarios include local children and adult residents exposed to PFOA in off-site soils, groundwater, municipal water, fish from the Tennessee River, and surface water and sediments in the Tennessee River. According to 3M, estimated off-site exposure of local residents to PFOA ranged from 0.011 to 260 ng/kg/day, with the highest estimated exposure

5. POTENTIAL FOR HUMAN EXPOSURE

corresponding to children whose source of drinking water was groundwater adjacent to the southern side of the facility.

CHAPTER 6. ADEQUACY OF THE DATABASE

Section 104(i)(5) of CERCLA, as amended, directs the Administrator of ATSDR (in consultation with the Administrator of EPA and agencies and programs of the Public Health Service) to assess whether adequate information on the health effects of perfluoroalkyls is available. Where adequate information is not available, ATSDR, in conjunction with NTP, is required to assure the initiation of a program of research designed to determine the adverse health effects (and techniques for developing methods to determine such health effects) of perfluoroalkyls.

Data needs are defined as substance-specific informational needs that, if met, would reduce the uncertainties of human health risk assessment. This definition should not be interpreted to mean that all data needs discussed in this section must be filled. In the future, the identified data needs will be evaluated and prioritized, and a substance-specific research agenda will be proposed.

6.1 Existing Information on Health Effects

Studies evaluating the health effects of inhalation, oral, and dermal exposure of humans and animals to PFOA, PFOS, and other perfluoroalkyls that are discussed in Chapter 2 are summarized in Figures 6-1, 6-2, and 6-3, respectively. The purpose of these figures is to illustrate the information concerning the health effects of perfluoroalkyls. The number of human and animal studies examining each endpoint is indicated regardless of whether an effect was found and the quality of the study or studies.

As illustrated in Figures 6-1, 6-2, and 6-3, most of the data on the toxicity of PFOA, PFOS, and other perfluoroalkyls come from epidemiology studies in humans; oral exposure is the assumed route of exposure for the epidemiology studies. The epidemiology database consists of health evaluations of subjects exposed in occupational settings (primarily PFOA and PFOS), highly exposed residents living near a PFOA facility, and studies of the general population. The most commonly examined endpoints examined in the epidemiology studies were developmental, hepatic, reproductive, and immunological effects.

6. ADEQUACY OF THE DATABASE

Figure 6-1. Summary of Existing Health Effects Studies on PFOA By Route and Endpoint*

Potential body weight, hepatic, and developmental effects were the most studied endpoints

The majority of the studies examined oral exposure in **humans** (versus **animals**)

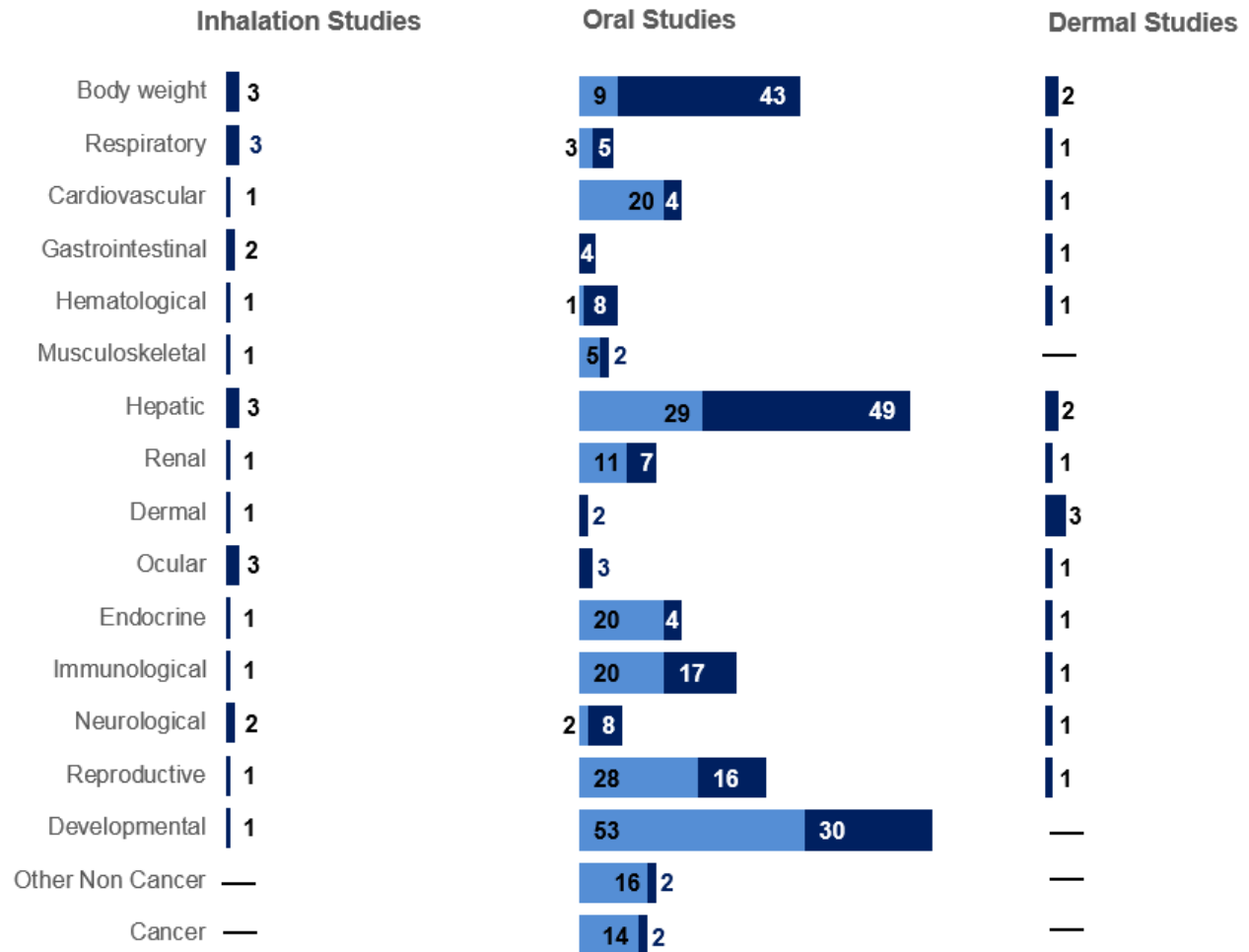

*In this figure, the number of human studies is referring to the number of publications; a “—” indicates that no studies are available.

6. ADEQUACY OF THE DATABASE

Figure 6-2. Summary of Existing Health Effects Studies on PFOS By Route and Endpoint*

Potential developmental, hepatic, reproductive, and body weight effects were the most studied endpoints

The studies examined oral exposure in **humans** (versus **animals**)

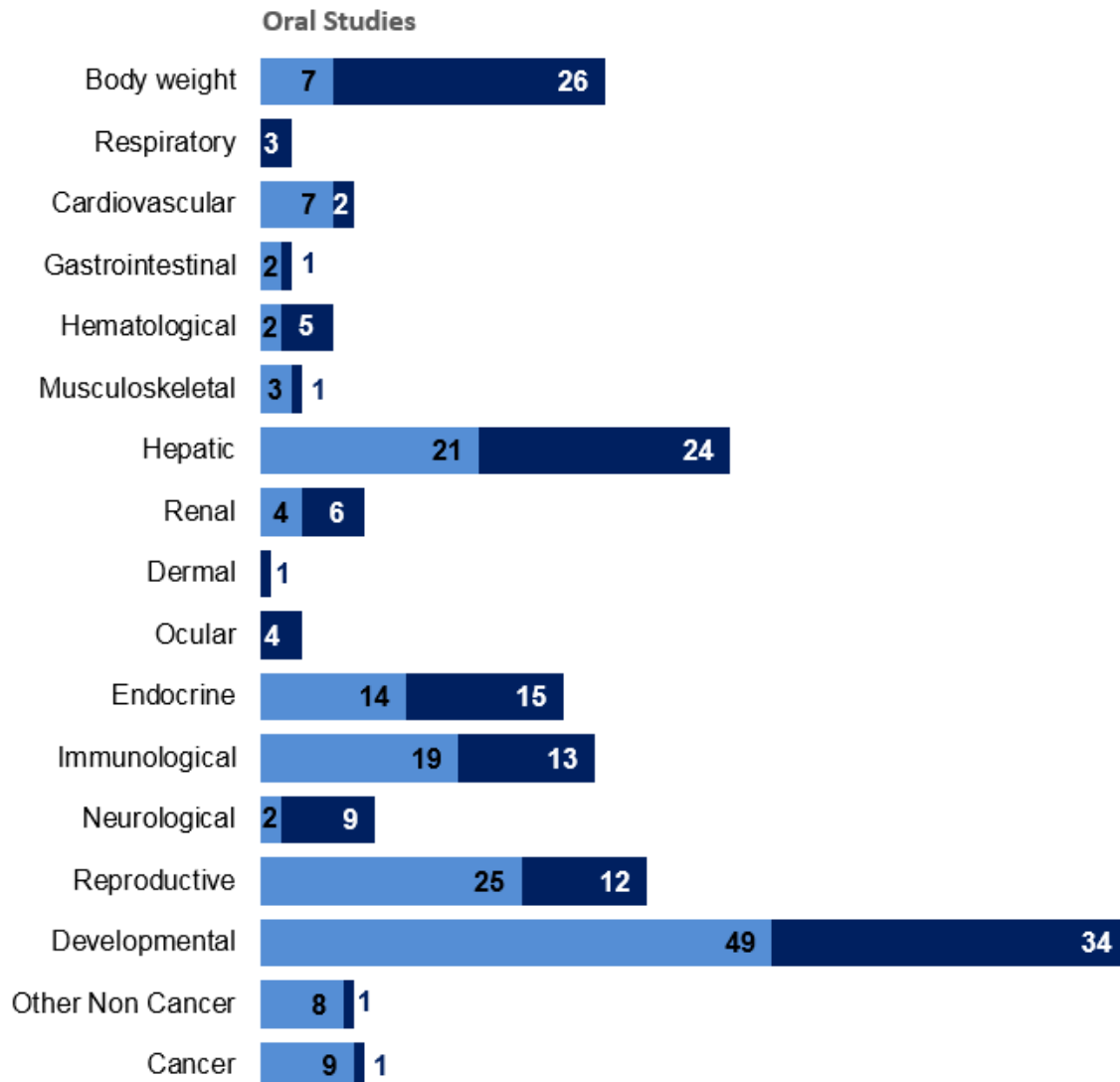

*Oral exposure was the presumed route of exposure for epidemiology studies; in this figure, the number of human studies is referring to the number of publications.

6. ADEQUACY OF THE DATABASE

Figure 6-3. Summary of Existing Health Effects Studies on Other Perfluoroalkyls By Route and Endpoint*

Potential body weight, hepatic, and developmental effects were the most studied endpoints

The majority of the studies examined oral exposure in **humans** (versus **animals**)

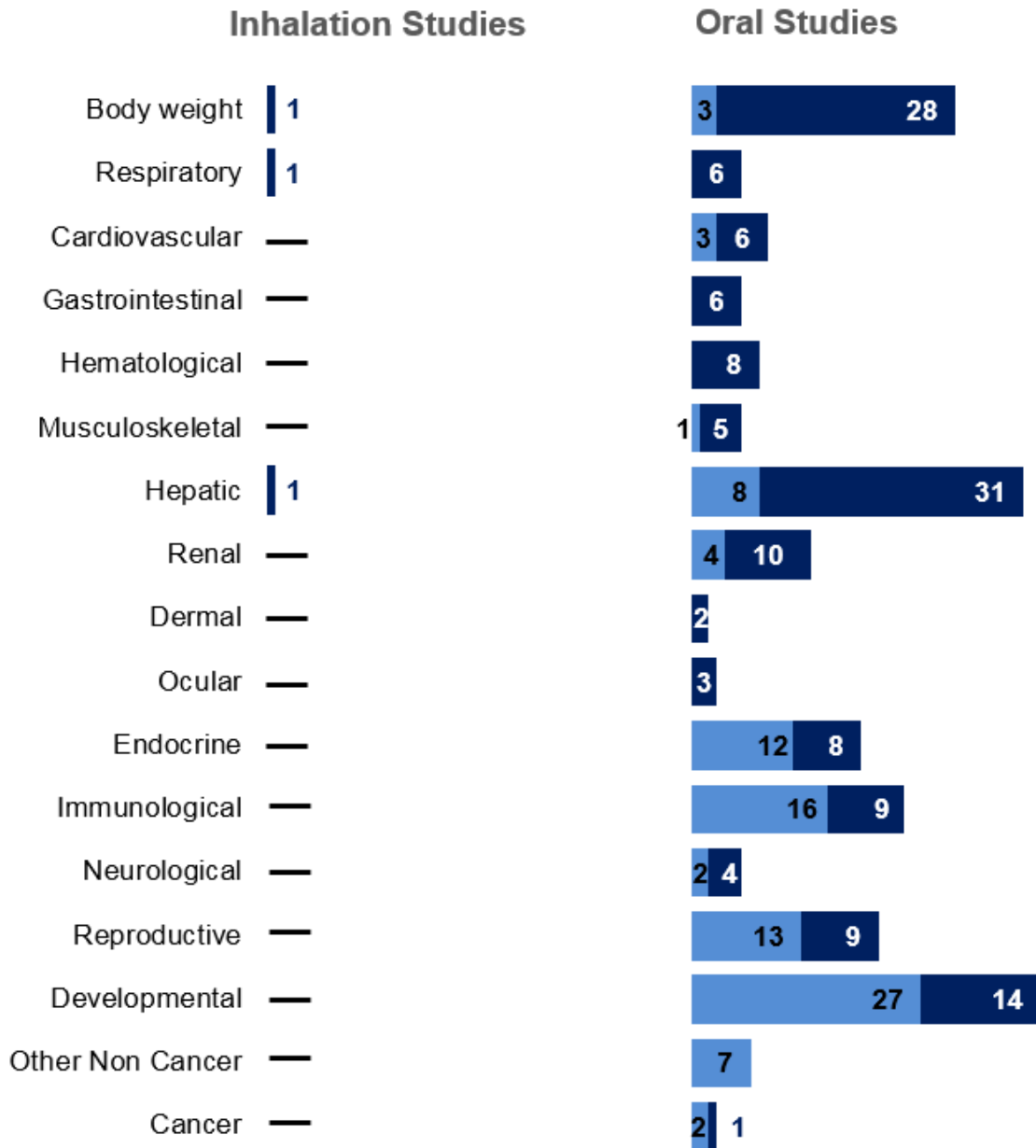

*In this figure, the number of human studies is referring to the number of publications; a “—” indicates that no studies are available. Includes data for PFBA, PFHxA, PFHpA, PFNA, PFDeA, PFUA, PFBU, PFHxS, PFDoA, PFOSA, Me-PFOSA-AcOH, and Et-PFOSA-AcOH.

6. ADEQUACY OF THE DATABASE

Studies in laboratory animals have primarily been conducted using oral exposure. Most of the information regarding the effects of perfluoroalkyl compounds in animals has been derived from oral studies; considerably less information is available from inhalation and dermal exposure studies. PFOA and PFOS have been the most extensively studied members of this class of chemicals, and oral administration has been the preferred route of exposure in animal studies. Information regarding other perfluoroalkyls covered in this profile is limited to acute-duration oral studies with PFNA, PFDeA, PFBA, PFDoA, and PFOSA; intermediate-duration oral studies with PFHxS, PFNA, PFUA, PFBuS, PFBA, PFDoA, and PFHxA; and a chronic-duration oral study with PFHxA. An acute-duration-inhalation study with PFNA is also available. The most commonly examined endpoints were hepatic, body weight, developmental, reproductive, and immunological effects.

6.2 Identification of Data Needs

Missing information in Figures 6-1, 6-2, and 6-3 should not be interpreted as a “data need.” A data need, as defined in ATSDR’s *Decision Guide for Identifying Substance-Specific Data Needs Related to Toxicological Profiles* (ATSDR 1989), is substance-specific information necessary to conduct comprehensive public health assessments. Generally, ATSDR defines a data gap more broadly as any substance-specific information missing from the scientific literature.

Acute-Duration MRLs. The available acute inhalation database for PFOA was considered inadequate for derivation of an MRL due to lack of measured serum PFOA levels in the available animal studies and the lack of PBPK model parameters that could be used to predict serum levels. The inhalation database for PFNA was not considered adequate due to the limited endpoints examined and the short exposure duration of the only available study. No inhalation data were available for PFOS or the other perfluoroalkyl compounds. A number of studies have evaluated the acute toxicity of PFOA and PFOS following oral exposure and have identified several sensitive targets of toxicity. Smaller numbers of studies evaluated potential sensitive targets of acute toxicity for PFNA and PFDeA. However, toxicokinetic differences between humans and laboratory animals, particularly the relative short half-life in rodents compared to humans, preclude derivation of an acute MRL for these compounds. For other perfluoroalkyls (PFHxS, PFBA, PFDoA, PFOSA), the available studies were not considered adequate for identification of critical targets; did not examine sensitive targets that were identified for other perfluoroalkyl compounds, such as developmental and immunological endpoints; or involved a single exposure. No acute oral data were identified for PFUA, PFHpA, or PFBuS. Research is needed to develop a PBPK model that would allow for extrapolation from rodents to humans. Additionally, toxicity

6. ADEQUACY OF THE DATABASE

studies are needed for most perfluoroalkyl compounds to identify critical targets of toxicity and/or establish dose-response relationships. These studies should examine developmental and reproductive endpoints that have been established as the most sensitive targets of toxicity for PFOA and PFOS.

Intermediate-Duration MRLs. No intermediate-duration inhalation studies were identified for perfluoroalkyl compounds. Oral studies suggest that developmental and immune effects are the most sensitive targets of toxicity; similar effects are likely to occur following inhalation exposure because perfluoroalkyl compounds are not metabolized. Inhalation studies are needed to establish dose-response relationships and to establish whether the respiratory tract is a sensitive target of toxicity. The intermediate-duration oral databases were considered adequate for derivation of provisional MRLs for PFOA and PFOS. A modifying factor was used for PFOS due to the lack of PBPK modeling parameters that would allow for predicting steady-state serum PFOS levels for immunotoxicity studies in laboratory animals. Provisional intermediate-duration MRLs were also derived for PFHxS and PFNA; however, these were based on marginal databases and additional dose-response studies are needed to support the basis of the MRL. The databases were not considered adequate for PFUA, PFBuS, PFBA, or PFDoA due to the lack of studies examining potential sensitive targets (developmental and/or immune effects). No intermediate-duration oral studies are available for PFDeA, PFHpA, or PFOSA. Intermediate-duration oral studies are needed for these seven perfluoroalkyls to provide information on sensitive targets and establish dose-response relationships. These studies should include measurement of serum perfluoroalkyl levels, which would allow for estimating human equivalent doses (HEDs).

Chronic-Duration MRLs. The lack of chronic-duration inhalation studies for perfluoroalkyl compounds precluded derivation of chronic MRLs. Chronic toxicity studies examining a wide range of endpoints are needed to identify the most sensitive target and establish concentration-response relationships. A small number of chronic duration oral studies have been identified in laboratory animals. Four studies examined the chronic toxicity of PFOA, PFOS, or PFHxA. These studies were not considered suitable for derivation of MRLs because they did not evaluate immunotoxicity which was a sensitive target following shorter term exposures. Studies examining this potentially sensitive endpoint are needed to identify the most sensitive target following chronic exposure.

Health Effects. Over 600 studies have evaluated the toxicity of perfluoroalkyl compounds; epidemiology studies account for over 400 of the toxicity studies. Evidence from epidemiology studies suggest links between perfluoroalkyl exposure and several health outcomes including liver damage, increases in serum lipids, thyroid disease, immune effects, reproductive toxicity, and developmental

6. ADEQUACY OF THE DATABASE

toxicity. The primary health effects observed in laboratory animals are liver, developmental, and immune toxicity. Although a large number of studies evaluating health effects are available, there is a need for additional studies to address data gaps. Future laboratory animal studies should include measurement of serum perfluoroalkyl levels, as this would provide valuable information for comparing effects observed in laboratory animals to effects observed in humans.

Hepatic Effects. Evidence from acute, intermediate, and/or chronic oral studies in rats, mice, and monkeys indicates that the liver is a sensitive target of PFOA, PFOS, PFHxS, PFNA, PFDeA, PFUA, PFBA, PFBuS, PFDoA, and PFHpA toxicity. The effects observed in rodents differ from those observed in humans. In humans, exposure to PFOA, PFOS, PFNA, and PFDeA appear to result in increases in serum lipid levels, particularly total cholesterol levels. However, animal studies have found decreases in serum lipid levels associated with exposure to most perfluoroalkyls. It is not known if the species differences are due to different mechanisms of toxicity or differences in exposure levels (serum levels observed in animal studies are orders of magnitude higher than those in human studies).

Immune Effects: Epidemiology data suggest a link between PFOA, PFOS, PFHxS, and PFDeA and decreased antibody response to vaccines. This is supported by acute- and intermediate-duration studies of PFOA and PFOS in laboratory animals. There is also evidence of immunotoxicity following a single injection of PFNA; some of the immune effects persisted 4 weeks post-exposure. Shorter-term studies are needed for other perfluoroalkyl compounds. In addition, chronic-duration studies evaluating immune endpoints, particularly immunosuppression, for all perfluoroalkyls would allow for identification of the critical targets of toxicity.

Reproductive Effects. Decreases in mammary gland development have been demonstrated in several PFOA mouse studies. The effect levels observed in these studies are very low, although there is some indication that at lower doses, the changes in mammary gland development do not affect lactation. Additional studies are needed to evaluate the adversity of these alterations. This endpoint has not been evaluated for other perfluoroalkyl compounds and studies are needed to determine whether it is also a sensitive effect for these compounds.

Developmental Effects. Based on the results of laboratory animal studies, developmental endpoints are targets of PFOA, PFOS, PFHxS, PFNA, PFDeA, PFUA, and PFBA toxicity following acute- and/or intermediate-duration oral exposure. Studies are needed to evaluate potential

6. ADEQUACY OF THE DATABASE

developmental effects for PFHxS following intermediate-duration oral exposure. Epidemiology studies in children suggest altered responses to vaccination; two animal studies have evaluated immune effects following perinatal exposure to PFOA and PFOS, but data are lacking for other perfluoroalkyls.

Potential Interactions Between Perfluoroalkyls. A common limitation of the epidemiology data is co-exposure to multiple perfluoroalkyl compounds. There are limited data on possible interactions between perfluoroalkyl compounds and possible effects on toxicity and toxicokinetics. Animal studies examining the possible interactions between perfluoroalkyl compounds would be useful for interpreting the epidemiology study results; this is especially important since humans are typically exposed to multiple perfluoroalkyls and many of them are likely to have similar mechanisms of action.

Mechanisms of Toxicity. Many of the effects observed in rodents, particularly liver and developmental effects, involve the activation of PPAR α ; humans and nonhuman primates are less responsive to PPAR α agonists than rats and mice. However, the results of studies in PPAR α -null mice suggest that PPAR α -independent mechanisms also play a role in the liver, immunological, and developmental toxicity. Additional studies are needed on the mechanisms of toxicity to assess whether the effects observed in laboratory animal are relevant to humans.

Epidemiology and Human Dosimetry Studies. As previously mentioned, information is available regarding the effects of exposure to perfluoroalkyl compounds in humans derived from health evaluations of subjects exposed in occupational settings, residents living near a PFOA manufacturing facility with high levels of PFOA in the drinking water, and the general population. Although many studies found statistically significant associations between serum perfluoroalkyl levels and the occurrence of an adverse health effect, the findings were not consistent across studies. Interpretation of the human data is limited by the reliance of cross-sectional studies, which do not establish causality, and the lack of exposure data. Studies on serum lipids suggest that the dose-response curve is steeper at lower concentrations and flattens out at higher serum perfluoroalkyl concentrations (Steenland et al. 2010a); additional studies that could be used to establish dose-response relationships would be valuable. Mechanistic studies examining the association between perfluoroalkyl exposure and serum lipid levels would also provide valuable insight. Clarification of the significance and dose-response relationships for other observed effects is also needed. Longitudinal studies examining a wide range of endpoints would be useful for identifying critical targets of toxicity in humans exposed to perfluoroalkyls. The available human studies have identified

6. ADEQUACY OF THE DATABASE

some potential targets of toxicity; however, cause-and-effect relationships have not been established for any of the effects, and the effects have not been consistently found in all studies. Mechanistic studies would be useful for establishing causality. When possible, health assessments should include subjects of different race/ethnicity and age to determine potential race/ethnicity- and age-based susceptibilities. Another limitation of the epidemiology studies is co-exposure to other perfluoroalkyl compounds; studies that statistically controlled for co-exposure to other pollutants would decrease this uncertainty. As noted previously, there is a need for studies evaluating potential interactions between perfluoroalkyl compounds.

Biomarkers of Exposure and Effect. Data are available regarding levels of perfluoroalkyl compounds in serum from the general population, highly exposed residents, and perfluoroalkyl workers. Information is needed regarding the toxicokinetics (see also below) of perfluoroalkyl compounds in humans to be able to relate levels of these compounds in serum to exposure to specific perfluoroalkyls; data on matched serum and urine samples would be valuable. Also needed is further information on the relationship between serum and liver concentrations of perfluoroalkyl compounds in humans.

Absorption, Distribution, Metabolism, and Excretion. Several epidemiology studies have examined the kinetics of serum perfluoroalkyl concentrations following a change in environmental or occupational exposure, from which estimates of terminal elimination half-lives in adults are available for PFOA, PFOS, PFHxS, PFBA, and PFBS. Other studies provide data on the renal clearances of PFOA and PFOS, binding of PFOA, PFOS, and PFHxS to human plasma protein, tissue levels (primarily blood, maternal and fetal cord serum, and breast milk). Data on other aspects of the toxicokinetics of perfluoroalkyls in humans are not available and could serve to improve predictions of internal dosimetry associated with exposures to perfluoroalkyls (bioavailability, kinetics of tissue distribution and elimination, binding in tissues, external-internal dose relationships, all aspects of toxicokinetics in children and aging populations).

Toxicokinetics of perfluoroalkyls have been studied much more extensively in rodents (rats and mice) and less extensively in *Cynomolgus* monkeys; however, a number of data gaps have been identified:

- Absorption studies; oral absorption data are available for PFOA, PFOS, and PFBA, but are more limited for other perfluoroalkyl compounds and for other exposure routes. Studies elucidating the mechanisms of pulmonary and gastrointestinal absorption are also needed.
- Studies have shown that elimination kinetics, and therefore, internal dose-external dose relationships, are dependent on structure, including the terminal acid group (carboxylate or

6. ADEQUACY OF THE DATABASE

sulfonate), carbon chain length, and carbon chain branching. These structural features affect plasma and tissue protein binding, renal and biliary clearances, tissue levels, maternal-fetal transfer, and lactational transfer of perfluoroalkyls. Studies examining differences between perfluoroalkyl compounds would be useful for extrapolating health effects and toxicokinetic data across compounds.

- Toxicokinetic studies have found sex- and dose-dependent subcellular distribution of PFOA in rats. Further studies on the mechanisms for dose-dependency, characterization of subcellular binding proteins, and mechanistic linkages between subcellular distribution and toxicity of perfluoroalkyls are needed.
- The distribution and elimination of PFOA and PFOS are greatly influenced by binding interactions with albumin and other high molecular weight plasma proteins; available data suggest that binding to plasma proteins, as well as the volume of distribution, may be sex- and species-specific. Interactions with albumin have been partially characterized to the extent that binding capacity and affinity constants have been estimated, but the rates of association and dissociation have not been reported.
- Liver uptake and renal clearance of PFOS also appeared to be time-dependent in a PBPK model used to predict plasma and liver in concentrations of PFOS in a chronic rat study (Harris and Barton et al. 2008). Mechanisms underlying these time dependencies have not been elucidated.

Comparative Toxicokinetics. Toxicokinetic studies conducted in various rodent species (mice, rats, hamsters, rabbits) and in *Cynomolgus* monkeys have revealed profound species and sex differences as well as dose dependencies in the tissue distribution and elimination kinetics of PFOA and PFOS. Studies conducted in rats have revealed contributing mechanisms for sex differences in elimination of PFOA; slower elimination of PFOA in male rats compared to female rats has been attributed to sex hormone-modulated renal tubular transport of PFOA that results in markedly lower renal clearance of PFOA in the sexually mature male rat (see Section 3.5.1, Excretion). Sex differences in elimination of PFOA have also been observed in hamsters; unlike the rat, male hamsters excreted absorbed PFOA more rapidly than female hamsters. Sex differences in elimination of PFOA have not been observed in other rodent species, in *Cynomolgus* monkeys, or in limited observations made in humans. Sex differences in elimination rates of perfluoroalkyls in humans have not been demonstrated in population studies of serum elimination kinetics or renal clearance. Although the few studies that estimated elimination half-lives or renal clearances in male and female humans have not found significant sex differences, these outcomes may reflect the relatively low serum concentrations in these subjects compared with studies that were conducted in nonhuman primates and rodents (i.e., sex differences in elimination may vary with dose and/or plasma concentration). Additionally, the failure to account for the influence of reduced estrogen levels (in postmenopausal women) and reduced testosterone levels (in older males) in occupational and/or site-related epidemiology studies may also account for the lack of finding of sex-related differences.

6. ADEQUACY OF THE DATABASE

Children's Susceptibility. Data needs relating to both prenatal and childhood exposures, and developmental effects expressed either prenatally or during childhood, are discussed in the Health Effects subsection above. It is not known whether children are more or less susceptible than adults to the effects of exposure to perfluoroalkyl compounds because there are no studies that specifically addressed this question. Several studies have examined the possible associations between perfluoroalkyl exposure and health outcome in children living in an area with high PFOA contamination and in the general population. Although some studies have found statistically significant associations, they are not adequate for establishing causality. Follow-up studies of the C8 population could allow for a longitudinal assessment of health effects in children and would be useful in determining whether the observed effects are due to perfluoroalkyl exposure. Toxicokinetics information in children is needed. Half-life studies have been conducted in adults; there is the need to understand if these are applicable to children. There are no studies that have examined whether young animals are more or less susceptible than adults to perfluoroalkyls toxicity. Additional information on this issue would be useful.

Physical and Chemical Properties. Perfluoroalkyl compounds have unique and complex physical and chemical properties (Kissa 2001; Schultz et al. 2003). Sources are available that provide helpful insights into the structural aspects and surfactant nature of these substances; however, many of the properties are still not well understood (CEMN 2008; Kissa 2001; Schultz et al. 2003). In general, specific properties such as physical state, melting point, boiling point, density, solubility, vapor pressure, micelle formation, and acid dissociation in water have not been determined or are not well described for these compounds. Measurements of these endpoints are needed. Information regarding the potential association of these species in water would be useful. Where determination of a particular endpoint is not possible, a thorough description of the physical and chemical properties as they relate to that endpoint would be helpful. Perfluoroalkyls discussed in this profile exist as a mixture of linear and branched isomers. Isomer-specific data would also be useful for the various physical-chemical properties. Wang et al. (2013b) identified several of the fluorinated compounds that are currently being used by major manufacturers as alternatives to PFOA and PFOS. These compounds are being used as processing aids in the emulsion polymerization of PTFE and other polymers as well as surface treatment uses, metal plating uses, firefighting foams, and other miscellaneous uses such as food contact materials. A data need exists to determine the physical and chemical properties of these replacement substances.

The production, use, import, and export of perfluoroalkyl compounds have changed dramatically since 2000. Most nations no longer produce or use PFOS or PFOA (China is a notable exception). Major fluoropolymer manufacturers in the United States have altered their chemical processes to use alternative

6. ADEQUACY OF THE DATABASE

fluorinated substances in their production processes. Information regarding the production, import, and export volumes of these substances is needed.

Recommended methods for the disposal of perfluoroalkyl compounds have not been located. In the past, perfluoroalkyl-containing waste has been disposed of in on- and off-site landfills, through sludge incorporation, and through incineration (3M 2007b, 2008b; ATSDR 2005). New disposal methods that avoid release of these substances into the open environment and prevent contamination of nearby soil, sediment, and groundwater should be developed. The eventual breakdown of fluorotelomer-based polymers with the eventual release of substances such as PFOA is not well understood. Early researchers have concluded that the half-life for this process is >1,000 years; however, more recent data suggest much shorter time scale of 1–2 decades (Rankin et al. 2014; Washington and Jenkins 2015; Washington et al. 2009, 2014, 2015). Additional studies on the potential release of perfluoroalkyls from the eventual degradation of fluoropolymers in landfills would be useful.

Environmental Fate. Perfluoroalkyls are very stable compounds and are resistant to biodegradation, direct photolysis, atmospheric photooxidation, and hydrolysis (3M 2000; EPA 2008a; OECD 2002, 2007; Schultz et al. 2003). The chemical stability of perfluoroalkyls and the low volatility of these substances in ionic form indicate that perfluoroalkyls will be persistent in water and soil (3M 2000; Prevedouros et al. 2006). K_{oc} values ranging from 17 to 230 indicate that PFOA will be mobile in soil and can leach into groundwater (Davis et al. 2007; Prevedouros et al. 2006). Environmental fate and potential pathways of PFOA exposure at and near the DuPont Washington Works site have been discussed (Small 2009). Wang et al. (2013b) identified several of the fluorinated compounds that are currently being used by major manufacturers as alternatives to PFOA and PFOS. A data need exists to determine the fate properties of these replacement substances.

Bioavailability from Environmental Media. Perfluoroalkyls are widely detected in humans and animals, indicating that several of these substances are bioavailable. The bioaccumulation potential of perfluoroalkyls is reported to increase with increasing chain length (de Vos et al. 2008; Furdui et al. 2007; Martin et al. 2004b). In living organisms, perfluoroalkyls bind to protein albumin in blood, liver, and eggs and do not accumulate in fat tissue (de Vos et al. 2008; Kissa 2001). The mechanism of perfluoroalkyl uptake in animals is not fully understood; additional studies would be helpful (de Vos et al. 2008). Perfluoroalkyls discussed in this profile exist as a mixture of linear and branched isomers. Data regarding the bioavailability of branched versus linear substances would be useful. A data need exists to

6. ADEQUACY OF THE DATABASE

determine the bioavailability of the replacement substances identified in Wang et al. (2013b) used in place of PFOA and PFOS.

Food Chain Bioaccumulation. High levels of certain perfluoroalkyls in animals have been measured in apex predators, such as polar bears, which indicates that some perfluoroalkyls possess the ability to bioaccumulate (de Vos et al. 2008; Houde et al. 2006a; Kannan et al. 2005; Smithwick et al. 2005a, 2005b, 2006). Perfluoroalkyl sulfonates with carbon chain length lower than 8 tend to bioaccumulate less than PFOS. Ongoing monitoring of perfluoroalkyl levels in animals may help to determine whether efforts to phase out these substances will have had an effect on their biomagnification. A data need exists to determine the bioaccumulation potential of the new replacement substances used in place of PFOA and PFOS.

Exposure Levels in Environmental Media. Reliable monitoring data for the levels of perfluoroalkyls in contaminated media at hazardous waste sites are needed so that the information obtained on levels of perfluoroalkyls in the environment can be used in combination with the known body burden of perfluoroalkyls to assess the potential risk of adverse health effects in populations living in the vicinity of hazardous waste sites.

Concentrations of perfluoroalkyls have been measured in surface water from several locations across the United States (Boulanger et al. 2004; Kannan et al. 2005; Kim and Kannan 2007; Nakayama et al. 2007; Simcik and Dorweiler 2005; Sinclair et al. 2004, 2006). Continued monitoring for perfluoroalkyls in surface water would be useful. Data are available regarding levels of perfluoroalkyls in outdoor air, indoor air, indoor dust, food, food packaging, and consumer products (3M 2001; Barber et al. 2007; Begley et al. 2005; Food Standards Agency 2006; Fromme et al. 2007b; Harada et al. 2005b, 2006; Jogsten et al. 2009; Kim and Kannan 2007; Kubwabo et al. 2005; Moriwaki et al. 2003; Tittlemier et al. 2007; Washburn et al. 2005). Comprehensive studies monitoring for perfluoroalkyls in these matrices within the United States are needed. Elevated concentrations of perfluoroalkyls have been measured in air, water, soil, and sediment near fluorochemical industrial facilities (3M 2007b, 2008b, 2008c; Barton et al. 2006; Davis et al. 2007; Hansen et al. 2002). Continued monitoring for perfluoroalkyls in these matrices are needed to assess exposure of individuals working at these locations and individuals who live near these facilities. A data need also exists to perform environmental monitoring of the replacement substances identified in Wang et al. (2013b) used in place of PFOA and PFOS, particularly near manufacturing locations.

6. ADEQUACY OF THE DATABASE

Exposure Levels in Humans. Trudel et al. (2008) provided a thorough assessment of the exposure of the general population to PFOS and PFOA. 3M (2008b) provided an assessment of exposure of individuals to PFOA on-site at a fluoropolymer facility. Uptake values and exposure pathways determined in these studies should be examined further. Conclusions made in these assessments are expected to be adjusted as future monitoring data are made available. Large-scale monitoring of perfluoroalkyls in human serum in the United States is ongoing (Calafat et al. 2006a). Future results of human monitoring studies would be useful for assessing human exposure to these substances over time. The results of these studies can be examined for correlations between human perfluoroalkyl levels and the phasing out of perfluoroalkyl compounds by companies of the fluorochemical industry. Levels of perfluoroalkyl compounds in human urine have been reported (Jurado-Sanchez et al. 2014). Higher exposure levels for individuals who reside in areas where substances such as PFOA contaminated both public and private water supplies have been documented (Emmett et al. 2006a, 2009). Continued biomonitoring of legacy compounds such as PFOA and PFOS as well as replacement substances is needed.

This information is necessary for assessing the need to conduct health studies on these populations.

Exposures of Children. Trudel et al. (2008) provided a thorough assessment of the exposure of children to PFOS and PFOA. These conclusions should be reexamined with respect to future biomonitoring data when they become available. Data are available regarding the levels of perfluoroalkyls in young children (Kato et al. 2009b; Olsen et al. 2004b; Toms et al. 2009). NHANES monitoring data for 2013–2014 for children of ages 3–11 years have recently been released (CDC 2018; Ye et al. 2018a). Data provided from these efforts will be useful in assessing the exposure of young children to perfluoroalkyls.

Concentrations of perfluoroalkyls have been measured in human breast milk and cord blood (Apelberg et al. 2007a, 2007b; Fei et al. 2007; Inoue et al. 2004; Kärman et al. 2007; Midasch et al. 2007; So et al. 2006b; Völkel et al. 2008). Additional monitoring for perfluoroalkyls in these media would be useful. Continued biomonitoring of legacy compounds such as PFOA and PFOS as well as replacement substances is needed.

6. ADEQUACY OF THE DATABASE

6.3 Ongoing Studies

A number of ongoing studies were identified in NIH Reporter (2017), these studies are summarized in Table 6-1.

Table 6-1. Ongoing Studies on Perfluoroalkyls

Investigator	Affiliation	Research description	Sponsor
Bruan J	Brown University	Early life exposure to PFOA, PFOS, PFNA, and PFHxS on obesity mechanisms and phenotyping	NIEHS
Chen, A	University of Cincinnati	Longitudinal study of exposure to PBDEs and PFCs and child neurobehavior	NIEHS
Fenton S	NIEHS	Examination of the mammary gland as a sensitive endpoint to effects of endocrine disruptors	NIEHS
Frisbee S	West Virginia University	Study of the effects of perfluoroalkyl chemicals on stroke incidence, mortality and morbidity in humans	NIGMS
Hijtmancik M	Battelle Centers	Chronic toxicity and carcinogenicity study of PFOA in rats	NIEHS
Hocevar B	Indiana University, Bloomington	Study of the promotion of pancreatic cancer by PFOA	NIEHS
Kissling G	NIEHS	PFOA-induced liver toxicity in wild and PPAR α -null rats and mice	NIEHS
Sagiv S	University of California, Berkeley	Prenatal exposure to perfluoroalkyls (PFOA, PFOS, PFHxS, PFNA) effect on growth and development in children	NIEHS
Shankar A	West Virginia University	Perfluoroalkyls (PFOA, PFOS, PFHxS, PFNA, PFHpA, PFDeA, PFUA, PFDoA, PFOSA, Et-PFOSA-AcOH, Me-PFOSA-AcOH) and the risk of developing clinical and subclinical cardiovascular disease in humans	NIEHS
Stein C	Icahn School of Medicine at Mount Sinai	Examination of possible associations between environmental toxicants (PFOA and other perfluoroalkyls) and child neurobehavioral development	NIEHS
Sun Q	Harvard School of Public Health	Examination of the relationship between perfluoroalkyls and other pollutants and the risk of diabetes in the Nurses' Health Study	NIEHS
Sun Q	Harvard School of Public Health	Perspective study of possible effects of perfluoroalkyls and other pollutants on body weight regulation	NIEHS

6. ADEQUACY OF THE DATABASE

Table 6-1. Ongoing Studies on Perfluoroalkyls

Investigator	Affiliation	Research description	Sponsor
Taylor L	Battelle Centers	Toxicity study of perfluorinated compounds using microarray analysis of rat liver samples	NIEHS

Source: NIH Reporter 2017

Et-PFOSA-AcOH = 2-(N-ethyl-perfluorooctane sulfonamide) acetic acid; Me-PFOSA-AcOH = 2-(N-methyl-perfluorooctane sulfonamide) acetic acid; NIEHS = National Institute of Environmental Health Sciences; NIGMS = National Institute of General Medical Sciences; PBDE = polybrominated diphenyl ether; PFC = perfluoro compound; PFDeA = perfluorodecanoic acid; PFDoA = perfluorododecanoic acid; PFHpA = perfluoroheptanoic acid; PFHxS = perfluorohexane sulfonic acid; PFNA = perfluorononanoic acid; PFOA = perfluorooctanoic acid; PFOS = perfluorooctane sulfonic acid; PFOSA = perfluorooctane sulfonamide; PFUA = perfluoroundecanoic acid

CHAPTER 7. REGULATIONS AND GUIDELINES

Pertinent international and national regulations, advisories, and guidelines regarding perfluoroalkyls in air, water, and other media are summarized in Table 7-1. This table is not an exhaustive list, and current regulations should be verified by the appropriate regulatory agency. A list of some select state drinking water regulations/guidelines or health based values are summarized in Table 7-2.

ATSDR develops MRLs, which are substance-specific guidelines intended to serve as screening levels by ATSDR health assessors and other responders to identify contaminants and potential health effects that may be of concern at hazardous waste sites. See Section 1.3 and Appendix A for detailed information on the provisional MRLs for perfluoroalkyls.

Table 7-1. Regulations and Guidelines Applicable to Perfluoroalkyls

Agency	Description	Information	Reference
Air			
EPA	RfC	No data	IRIS 2017
WHO	Air quality guidelines	No data	WHO 2010
Water & Food			
EPA	Drinking water standards and health advisories		
	Lifetime Health Advisory		
	PFOA	0.07 µg/L	EPA 2016e
	PFOS	0.07 µg/L	EPA 2016f
	National primary drinking water regulations	No data	EPA 2009d
	RfD	No data	IRIS 2017
	PFOA	2x10 ⁻⁵ mg/kg/day	EPA 2016e
	PFOS	2x10 ⁻⁵ mg/kg/day	EPA 2016f
WHO	Drinking water quality guidelines	No data	WHO 2017
FDA	EAFUS	No data ^a	FDA 2013
Cancer			
ACGIH	Carcinogenicity classification	No data	ACGIH 2016
HHS	Carcinogenicity classification	No data	NTP 2016a
EPA	Carcinogenicity classification	No data	IRIS 2017
IARC	Carcinogenicity classification		IARC 2017
	PFOA	Group 2B ^b	
Occupational			
ACGIH	TLV	No data	ACGIH 2016
OSHA	PEL (8-hour TWA) for general industry, shipyards and construction	No data	OSHA 2013 29 CFR 1910.1000, Table Z-1

7. REGULATIONS AND GUIDELINES

Table 7-1. Regulations and Guidelines Applicable to Perfluoroalkyls

Agency	Description	Information	Reference
	PEL (8-hour TWA) for shipyards and construction	No data	OSHA 2014b 29 CFR 1915.1000, Table Z
	PEL (8-hour TWA) for construction	No data	OSHA 2014a 29 CFR 1926.55, Appendix A
NIOSH	REL (up to 10-hour TWA)	No data	NIOSH 2016
Emergency Criteria			
EPA	AEGLs-air	No data	EPA 2016b
AIHA	ERPGs	No data	AIHA 2015
DOE	PACs-air		DOE 2016a
	PFOA		
	PAC-1 ^c	1.1 mg/m ³	
	PAC-2 ^c	12 mg/m ³	
	PAC-3 ^c	75 mg/m ³	
	PFBA		
	PAC-1 ^c	0.5 mg/m ³	
	PAC-2 ^c	5.5 mg/m ³	
	PAC-3 ^c	33 mg/m ³	

^aThe EAFUS list of substances contains ingredients added directly to food that FDA has either approved as food additives or listed or affirmed as GRAS.

^bGroup 2B: possibly carcinogenic to humans.

^cDefinitions of PAC terminology are available from DOE (2016b).

ACGIH = American Conference of Governmental Industrial Hygienists; AEGL = acute exposure guideline level; AIHA = American Industrial Hygiene Association; CFR = Code of Federal Regulations; DOE = Department of Energy; EAFUS = Everything Added to Food in the United States; EPA = Environmental Protection Agency; ERPG = emergency response planning guidelines; FDA = Food and Drug Administration; GRAS = generally recognized as safe; HHS = Department of Health and Human Services; IARC = International Agency for Research on Cancer; IRIS = Integrated Risk Information System; NIOSH = National Institute for Occupational Safety and Health; NTP = National Toxicology Program; OSHA = Occupational Safety and Health Administration; PAC = Protective Action Criteria; PEL = permissible exposure limit; PFOA = perfluorooctanoic acid; PFOS = perfluorooctane sulfonic acid; REL = recommended exposure limit; RfC = inhalation reference concentration; RfD = oral reference dose; TLV = threshold limit values; TWA = time-weighted average; WHO = World Health Organization

7. REGULATIONS AND GUIDELINES

Table 7-2. Select State Drinking Water and Daily Intake Levels for Perfluoroalkyls

Value type	Value (ppb or µg/L)						Reference
	PFOA	PFOS	PFBuS	PFBA	PFNA	PFHxS	
Maine							
Maximum exposure guideline for drinking water	0.07 ^a	0.07 ^a	ND	ND	ND	ND	MECDC 2016
Michigan							
Human noncancer drinking water value	0.42	0.011	ND	ND	ND	ND	Michigan DEQ 2016
Minnesota							
Health risk limit							MDH
Short-term	ND	ND	ND	7	ND	ND	2017a, 2017b
Subchronic	ND	ND	9	7	ND	ND	
Chronic	0.3	0.3	7	7	ND	ND	
Health-based value							
Short-term, subchronic or chronic	0.035	0.027	ND	7	ND	0.027 ^b	
Nevada							
Basic comparison level	0.667	0.667	667	ND	ND	ND	NDEP 2017
New Jersey							
Health-based chronic maximum contaminant level	0.014	0.013 (draft)	ND	ND	0.013	ND	DWQI 2015, 2017a, 2017b
North Carolina							
Interim maximum allowable concentration in groundwater	1.1–1.6	ND	ND	ND	ND	ND	NCDENR 2012, NC DEQ 2013
Vermont							
Drinking water health advisory	0.02 ^c	0.02 ^c	ND	ND	ND	ND	Vermont DOH 2017

^aMECDC notes that according to the U.S. EPA lifetime health advisory for PFOA and PFOS, when both PFOS and PFOA are present in drinking water combined levels are not to exceed 0.07 ppb ([EPA 2016j](#)).

^bMDH recommends using the health based value for PFOS (0.027 ppb) as a surrogate for PFHxS until more toxicological research on PFHxS is available ([MDH 2017b](#)).

^cSum of PFOS and PFOA not to exceed 0.02 µg/L.

DEC = Department of Environmental Conservation; DEQ = Department of Environmental Quality; DOH = Department of Health; DTSC = Department of Toxic Substances Control; DWQI = Drinking Water Quality Institute; MECDC = Maine Center for Disease Control & Prevention; MDH = Minnesota Department of Health; NCDENR = North Carolina Department of Environment and Natural Resources; ND = no data; NDEP = Nevada Division of Environmental Protection

CHAPTER 8. REFERENCES

- +3M. 1983. Two year oral (diet) toxicity/carcinogenicity study of fluorochemical FC-143 in rats. Washington, DC: U.S. Environmental Protection Agency. Submitted to the U.S. Environmental Protection Agency under TSCA Section 8E. OTS0204926-1.
- 3M. 1999. The science of organic fluorochemistry. U.S. Environmental Protection Agency. OPPT-2002-0043-0006. <http://www.fluoridealert.org/pesticides/pfos.fr.final.docket.0006.pdf>. July 08, 2008.
- 3M. 2000. Sulfonated perfluorochemicals in the environment: Sources; dispersion, fate and effects. 3M Company submission to the U.S. Environmental Protection Agency's Administrative Record. OPPT-2002-0043-0005.
- +3M. 2001. A 28-day oral (gavage) toxicity study of T-7485 in Sprague-Dawley rats. St Paul, MN: 3M Corporate Toxicology.
- +3M. 2007a. A 5-day repeat dose oral toxicity screening study in rats with a 7-day recovery period with MTDID. St. Paul, MN: 3M Corporate Toxicology.
- 3M. 2007b. Remedial investigation report. Phase 2. Fluorochemical (FC) data assessment report for the Cottage Grove, MN site. St. Paul, MN: 3M Corporate Toxicology.
- 3M. 2008a. Information about PFOS and PFOA. 3M Company. http://solutions.3m.com/wps/portal/3M/en_US/PFOS/PFOA/. April 01, 2008.
- 3M. 2008b. Data assessment report. 3M Decatur, Alabama facility PFOA site-related environmental monitoring program. St. Paul, MN: 3M Company.
- 3M. 2008c. Screening level human exposure assessment report. 3M Decatur, Alabama facility PFOA site-related environmental monitoring program. St. Paul, MN: 3M Company.
- 3M. 2010. GLP10-01-01, Interim report 10: Analysis of PFBS, PFHS, and PFOS in groundwater samples collected at off-site wells located in Decatur, AL in October 2010. In: Docket EPA-HQ-2004-0112-0155. Letter to USEPA, Docket Center, from Gary A. Hohenstein, Manager of Environmental and Regulatory Affairs, 3M Company. 3M. <https://www.regulations.gov/contentStreamer?documentId=EPA-HQ-OPPT-2004-0112-0155&attachmentNumber=9&contentType=pdf> February 28, 2017.
- 3M. 2012. E12-0849 Revised final report- Decatur soils- December 2012. <https://www.regulations.gov/contentStreamer?documentId=EPA-HQ-OPPT-2004-0112-0155&attachmentNumber=36&contentType=pdf> February 28, 2017.
- Abbott BD. 2009. Review of the expression of peroxisome proliferator-activated receptors alpha (PPAR α), beta (PPAR β), and gamma (PPAR γ) in rodent and human development. *Reprod Toxicol* 27(3-4, Sp. Iss. SI):246-257. 10.1016/j.reprotox.2008.10.001.
- +Abbott BD, Wolf CJ, Das KP, et al. 2009. Developmental toxicity of perfluorooctane sulfonate (PFOS) is not dependent on expression of peroxisome proliferator activated receptor-alpha (PPAR α) in the mouse. *Reprod Toxicol* 27(3-4):258-265.
- +Abbott BD, Wolf CJ, Schmid JE, et al. 2007. Perfluorooctanoic acid (PFOA)-induced developmental toxicity in the mouse is dependent on expression of peroxisome proliferator activated receptor-alpha. *Toxicol Sci* 98(2):571-581.
- Abbott BD, Wood CR, Watkins AM, et al. 2010. Peroxisome proliferator-activated receptors alpha, beta, and gamma mRNA and protein expression in human fetal tissues. *PPAR Res* 10.1155/2010/690907.
- Abbott BD, Wood CR, Watkins AM, et al. 2012. Effects of perfluorooctanoic acid (PFOA) on expression of peroxisome proliferator-activated receptors (PPAR) and nuclear receptor-regulated genes in fetal and postnatal CD-1 mouse tissues. *Reprod Toxicol* 33(4):491-505.

+ Cited in supplemental document

8. REFERENCES

- Abdellatif A, Al-Tonsy AH, Awad ME, et al. 2004. Peroxisomal enzymes and δ -hydroxydeoxyguanosine in rat liver treated with perfluorooctanoic acid. *Dis Markers* 19(1):19-25.
- Abdellatif AG, Preat V, Taper HS, et al. 1991. The modulation of rat liver carcinogenesis by perfluorooctanoic acid, a peroxisome proliferator. *Toxicol Appl Pharmacol* 111:530-537.
- ACGIH. 2016. CAS Number index. TLVs and BEIs based on the documentation of the threshold limit values for chemical substances and physical agents and biological exposure indices. Cincinnati, OH: American Conference of Governmental Industrial Hygienists, 233-250.
- Ahmed DY, Abd Ellah MR. 2012. Effect of exposure to perfluorooctanoic acid on hepatic antioxidants in mice. *Comp Clin Pathol* 21(6):1643-1645.
- AIHA. 2015. Current ERPG Values (2015). Fairfax, VA: American Industrial Hygiene Association. <https://www.aiha.org/get-involved/AIHAGuidelineFoundation/EmergencyResponsePlanningGuidelines/Documents/2015%20ERPG%20Levels.pdf>. March 22, 2016.
- +Albrecht PP, Torsell NE, Krishnan P, et al. 2013. A species difference in the peroxisome proliferator-activated receptor α -dependent response to the developmental effects of perfluorooctanoic acid. *Toxicol Sci* 131(2):568-582.
- Alexander BH, Olsen GW. 2007. Bladder cancer in perfluorooctanesulfonyl fluoride manufacturing workers. *Ann Epidemiol* 17(6):471-478.
- Alexander BH, Olsen GW, Burriss JM, et al. 2003. Mortality of employees of a perfluorooctanesulphonyl fluoride manufacturing facility. *Occup Environ Med* 60:722-729.
- Allen BC, Covington TR, Clewell HJ. 1996. Investigation of the impact of pharmacokinetic variability and uncertainty on risks predicted with a pharmacokinetic model for chloroform. *Toxicology* 111(1-3):289-303.
- Alves A, Jacobs G, Vanermen G, et al. 2015. New approach for assessing human perfluoroalkyl exposure via hair. *Talanta* 144:574-583. 10.1016/j.talanta.2015.07.009.
- Andersen CS, Fei C, Gamborg M, et al. 2010. Prenatal exposures to perfluorinated chemicals and anthropometric measures in infancy. *Am J Epidemiol* 172(11):1230-1237.
- Andersen CS, Fei C, Gamborg M, et al. 2013. Prenatal exposures to perfluorinated chemicals and anthropometry at 7 years of age. *Am J Epidemiol* 178(6):921-927.
- Andersen ME, Butenhoff JL, Chang SC, et al. 2008. Perfluoroalkyl acids and related chemistries-toxicokinetics and modes of action. *Toxicol Sci* 102(1):3-14.
- Andersen ME, Clewell HJ, Tan YM, et al. 2006. Pharmacokinetic modeling of saturable, renal resorption of perfluoroalkylacids in monkeys - probing the determinants of long plasma half-lives. *Toxicology* 227(1-2):156-164.
- Anderson RH, Long GC, Porter RC, et al. 2016. Occurrence of select perfluoroalkyl substances at U.S. Air Force aqueous film-forming foam release sites other than fire-training areas: Field-validation of critical fate and transport properties. *Chemosphere* 150:678-685. 10.1016/j.chemosphere.2016.01.014.
- Anderson-Mahoney P, Kotlerman J, Takhar H, et al. 2008. Self-reported health effects among community residents exposed to perfluorooctanoate. *New Solut* 18(2):129-143.
- Apelberg BJ, Goldman LR, Calafat AM, et al. 2007a. Determinants of fetal exposure to polyfluoroalkyl compounds in Baltimore, Maryland. *Environ Sci Technol* 41:3891-3897.
- Apelberg FJ, Witter FR, Herbstman JB, et al. 2007b. Cord serum concentrations of perfluorooctane sulfonate (PFOS) and perfluorooctanoate (PFOA) in relation to weight and size at birth. *Environ Health Perspect* 115:1670-1676.
- Armitage J, Cousins I, Buck RC, et al. 2006. Modeling global-scale fate and transport of perfluorooctanoate emitted from direct sources. *Environ Sci Technol* 40:6969-6975.
- Ashley-Martin J, Dodds L, Arbuckle TE, et al. 2016. Maternal and neonatal levels of perfluoroalkyl substances in relation to gestational weight gain. *Int J Environ Res Public Health* 13(1):146. 10.3390/ijerph13010146.

8. REFERENCES

- Ashley-Martin J, Dodds L, Levy AR. 2015. Prenatal exposure to phthalates, bisphenol A and perfluoroalkyl substances and cord blood levels of IgE, TSLP and IL-33. *Environ Res* 140:360-368.
- ATSDR. 1989. Decision guide for identifying substance-specific data needs related to toxicological profiles; Notice. Agency for Toxic Substances and Disease Registry, Division of Toxicology. *Fed Regist* 54(174):37618-37634.
- ATSDR. 2003. Guidance for the preparation of toxicological profiles. Agency for Toxic Substances and Disease Registry. <https://www.atsdr.cdc.gov/toxprofiles/index.asp#profiledevelopment>. July 6, 2017.
- ATSDR. 2005. Health consultation. 3M chemolite. Perfluorochemical releases at the 3M-Cottage Grove facility. Atlanta, GA: Agency for Toxic Substances and Disease Registry. http://www.atsdr.cdc.gov/HAC/pha/3M-CGF021805-MN/3M-CGF021805-MN_pt1.pdf. June 27, 2008.
- ATSDR. 2008. Public health Assessment for perfluorochemical contamination in Lake Elmo and Oakdale, Washington County, Minnesota. EPA facility ID: MND980704738 and MND980609515 August 29, 2008. Agency for Toxic Substances and Disease Registry. <http://www.health.state.mn.us/divs/eh/hazardous/sites/washington/lakeelmo/phaelmoakdale.pdf>. November 13, 2008.
- ATSDR. 2013. Health consultation. Exposure investigation report. Perfluorochemical serum sampling in the vicinity of Decatur, Alabama, Morgan, Lawrence, and Limestone counties. Atlanta, GA: Agency for Toxic Substances and Disease Registry, U.S. Department of Health and Human Services.
- ATSDR. 2017. Perfluoroalkyls. Full SPL data. Substance priority list (SPL) resource page. Agency for Toxic Substances and Disease Registry, Centers for Disease Control and Prevention. <http://www.atsdr.cdc.gov/SPL/resources/index.html>. October 6, 2017.
- Bach CC, Bech BH, Nohr EA, et al. 2016. Perfluoroalkyl acids in maternal serum and indices of fetal growth: The Aarhus Birth Cohort. *Environ Health Perspect* 10.1289/ehp.1510046.
- Bach CC, Bech BH, Nohr EA, et al. 2015a. Serum perfluoroalkyl acids and time to pregnancy in nulliparous women. *Environ Res* 142:535-541. 10.1016/j.envres.2015.08.007.
- Bach CC, Liew Z, Bech BH, et al. 2015b. Perfluoroalkyl acids and time to pregnancy revisited: An update from the Danish National Birth Cohort. *Environ Health* 14:59. 10.1186/s12940-015-0040-9.
- Bach CC, Liew Z, Bech BH, et al. 2015c. Additional file to perfluoroalkyl acids and time to pregnancy revisited: An update from the Danish National Birth Cohort [Environ Health 14:59]. *Environ Health* 10.1186/s12940-015-0040-9.
- Bae J, Kim S, Schisterman EF, et al. 2015. Maternal and paternal serum concentrations of perfluoroalkyl and polyfluoroalkyl substances and the secondary sex ratio. *Chemosphere* 133:31-40. 10.1016/j.chemosphere.2015.03.015.
- Barbarossa A, Masetti R, Gazzotti T, et al. 2013. Perfluoroalkyl substances in human milk: A first survey in Italy. *Environ Int* 51:27-30.
- Barber JL, Berger U, Chaemfa C, et al. 2007. Analysis of per- and polyfluorinated alkyl substances in air samples from Northwest Europe. *J Environ Monit* 9:530-541.
- Barnes DG, Dourson M. 1988. Reference dose (RfD): Description and use in health risk assessments. *Regul Toxicol Pharmacol* 8(4):471-486.
- Barrett ES, Chen C, Thurston SW, et al. 2015. Perfluoroalkyl substances and ovarian hormone concentrations in naturally cycling women. *Fertil Steril* 103(5):1261-1270 e1263. 10.1016/j.fertnstert.2015.02.001.
- Barry V, Darrow LA, Klein M, et al. 2014. Early life perfluorooctanoic acid (PFOA) exposure and overweight and obesity risk in adulthood in a community with elevated exposure. *Environ Res* 132:62-69.
- Barry V, Winquist A, Steenland K. 2013. Perfluorooctanoic acid (PFOA) exposures and incident cancers among adults living near a chemical plant. *Environ Health Perspect* 121(11-12):1313-1318.

8. REFERENCES

- Bartell SM, Calafat AM, Lyu C, et al. 2010. Rate of decline in serum PFOA concentrations after granular activated carbon filtration at two public water systems in Ohio and West Virginia. *Environ Health Perspect* 118(2):222-228.
- Barton CA, Butler LE, Zarzecki CJ, et al. 2006. Characterizing perfluorooctanoate in ambient air near the fence line of a manufacturing facility: Comparing modeled and monitored values. *J Air Waste Manag Assoc* 56:48-55.
- Barton CA, Kaiser MA, Russell MH. 2007. Partitioning and removal of perfluorooctanoate during rain events: The importance of physical-chemical properties. *J Environ Monit* 9:839-846.
- Beesoon S, Martin JW. 2015. Isomer-specific binding affinity of perfluorooctanesulfonate (PFOS) and perfluorooctanoate (PFOA) to serum proteins. *Environ Sci Technol* 49(9):5722-5731.
- Begley TH, White K, Honigfort P, et al. 2005. Perfluorochemicals: Potential sources of and migration from food packaging. *Food Addit Contam* 22(10):1023-1031.
- Benninghoff AD, Bisson WH, Koch DC, et al. 2011. Estrogen-like activity of perfluoroalkyl acids *in vivo* and interaction with human and rainbow trout estrogen receptors *in vitro*. *Toxicol Sci* 120(1):42-58.
- Benninghoff AD, Orner GA, Buchner CH, et al. 2012. Promotion of hepatocarcinogenesis by perfluoroalkyl acids in rainbow trout. *Toxicol Sci* 125(1):69-78. 10.1093/toxsci/kfr267.
- Benskin JP, De Silva AO, Martin LJ, et al. 2009. Disposition of perfluorinated acid isomers in Sprague-Dawley rats: Part 1: Single dose. *Environ Toxicol Chem* 28(3):542-554.
- Berg V, Nost TH, Hansen S, et al. 2015. Assessing the relationship between perfluoroalkyl substances, thyroid hormones and binding proteins in pregnant women; a longitudinal mixed effects approach. *Environ Int* 77:63-69. 10.1016/j.envint.2015.01.007.
- +Biegel LB, Hurtt ME, Frame SR, et al. 2001. Mechanisms of extrahepatic tumor induction by peroxisome proliferators in male CD rats. *Toxicol Sci* 60(1):44-55.
- +Biegel LB, Liu RC, Hurtt ME, et al. 1995. Effects of ammonium perfluorooctanoate on Leydig cell function: *In vitro*, *in vivo*, and *ex vivo* studies. *Toxicol Appl Pharmacol* 134(1):18-25.
- +Bijland S, Rensen PC, Pieterman EJ, et al. 2011. Perfluoroalkyl sulfonates cause alkyl chain length-dependent hepatic steatosis and hypolipidemia mainly by impairing lipoprotein production in APOE*3-Leiden CETP mice. *Toxicol Sci* 123(1):290-303. 10.1093/toxsci/kfr142.
- Bilott RA. 2004. PFOA-exposed community blood sample results (for AR-226 and OPPT-2003-0012). Submitted to the U.S. Environmental Protection Agency under TSCA Section FYI. http://www.epa.gov/oppt/tsca8e/pubs/8ehq/2004/oct04/fyi_1004_01480a.pdf. May 5, 2014.
- Bilott RA. 2005a. Perfluorochemical residential exposure data for Washington County, Minnesota. Submitted to the U.S. Environmental Protection Agency.
- Bilott RA. 2005b. Perfluorochemical residential exposure data for Washington County, Minnesota. Submitted to the U.S. Environmental Protection Agency. [http://yosemite.epa.gov/sab/sabproduct.nsf/1BF9ABCD791BDDE38525711F000156BE/\\$File/pfoa_sab_lett-bilott_05-20-05.pdf](http://yosemite.epa.gov/sab/sabproduct.nsf/1BF9ABCD791BDDE38525711F000156BE/$File/pfoa_sab_lett-bilott_05-20-05.pdf). May 5, 2014.
- Bilott RA. 2007. Perfluorochemical residential exposure data for Washington County, Minnesota. EPA-HQ-OPPT-2003-0012-1230. <https://www.regulations.gov/document?D=EPA-HQ-OPPT-2003-0012-1230>. February 28, 2017.
- Bischel HN, MacManus-Spencer LA, Zhang C, et al. 2011. Strong associations of short-chain perfluoroalkyl acids with serum albumin and investigation of binding mechanisms. *Environ Toxicol Chem* 30(11):2423-2430.
- Bjermo H, Darnerud PO, Pearson M, et al. 2013. Serum concentrations of perfluorinated alkyl acids and their associations with diet and personal characteristics among Swedish adults. *Mol Nutr Food Res* 57(12):2206-2215.
- Bjerregaard-Olesen C, Bach CC, Long M, et al. 2016. Time trends of perfluorinated alkyl acids in serum from Danish pregnant women 2008-2013. *Environ Int* 91:14-21. 10.1016/j.envint.2016.02.010.

8. REFERENCES

- Bjork JA, Wallace KB. 2009. Structure-activity relationships and human relevance for perfluoroalkyl acid-induced transcriptional activation of peroxisome proliferation in liver cell cultures. *Toxicol Sci* 111(1):89-99.
- Bjork JA, Butenhoff JL, Wallace KB. 2011. Multiplicity of nuclear receptor activation by PFOA and PFOS in primary human and rodent hepatocytes. *Toxicology* 288(1-3):8-17. 10.1016/j.tox.2011.06.012.
- Björklund JA, Thuresson K, de Wit CA. 2009. Perfluoroalkyl compounds (PFCs) in indoor dust: Concentrations, human exposure estimates, and sources. *Environ Sci Technol* 43(7):2276-2281.
- Blaine AC, Rich CD, Hundal LS, et al. 2013. Uptake of perfluoroalkyl acids into edible crops via land applied biosolids: Field and greenhouse studies. *Environ Sci Technol* 47:14062-14069.
- Blaine AC, Rich CD, Sedlacko EM, et al. 2014a. Perfluoroalkyl acid distribution in various plant compartments of edible crops grown in biosolids-amended soils. *Environ Sci Technol* 48(14):7858-7865. 10.1021/es500016s.
- Blaine AC, Rich CD, Sedlacko EM, et al. 2014b. Perfluoroalkyl acid uptake in lettuce (*Lactuca sativa*) and strawberry (*Fragaria ananassa*) irrigated with reclaimed water. *Environ Sci Technol* 48:14361-14368.
- Bloom MS, Kannan K, Spliethoff HM, et al. 2010. Exploratory assessment of perfluorinated compounds and human thyroid function. *Physiol Behav* 99(2):240-245.
- Bogdanska J, Borg D, Sundstrom M, et al. 2011. Tissue distribution of ³⁵S-labelled perfluorooctane sulfonate in adult mice after oral exposure to a low environmentally relevant dose or a high experimental dose. *Toxicology* 284(1-3):54-62.
- Bogdanska J, Sundstrom M, Bergstrom U, et al. 2014. Tissue distribution of ³⁵S-labelled perfluorobutanesulfonic acid in adult mice following dietary exposure for 1-5 days. *Chemosphere* 98:28-36.
- Boiteux V, Dauchy X, Rosin C, et al. 2012. National screening study on 10 perfluorinated compounds in raw and treated tap water in France. *Arch Environ Contam Toxicol* 63(1):1-12. 10.1007/s00244-012-9754-7.
- Bonefeld-Jorgensen EC, Long M, Bossi R, et al. 2011. Perfluorinated compounds are related to breast cancer risk in Greenlandic Inuit: A case control study. *Environ Health* 10:88. 10.1186/1476-069X-10-88.
- Bonefeld-Jorgensen EC, Long M, Fredslund SO, et al. 2014. Breast cancer risk after exposure to perfluorinated compounds in Danish women: A case-control study nested in the Danish National Birth Cohort. *Cancer Causes Control* 25(11):1439-1448. 10.1007/s10552-014-0446-7.
- Borg D, Bogdanska J, Sundstrom M, et al. 2010. Tissue distribution of ³⁵S-labelled perfluorooctane sulfonate (PFOS) in C57Bl/6 mice following late gestational exposure. *Reprod Toxicol* 30(4):558-565.
- Bossi R, Riget FF, Dietz R. 2005. Temporal and spatial trends of perfluorinated compounds in ringed seal (*Phoca hispida*) from Greenland. *Environ Sci Technol* 39:7416-7422.
- Boulanger B, Peck AM, Schnoor JL, et al. 2005. Mass budget of perfluorooctane surfactants in Lake Ontario. *Environ Sci Technol* 39:74-79.
- Boulanger B, Vargo J, Schnoor JL, et al. 2004. Detection of perfluorooctane surfactants in Great Lakes water. *Environ Sci Technol* 38:4064-4070.
- Brantsaeter AL, Whitworth KW, Ydersbond TA, et al. 2013. Determinants of plasma concentration of perfluoroalkyl substances in pregnant Norwegian women. *Environ Int* 54:74-84.
- Braun JM, Chen A, Romano ME, et al. 2016a. Prenatal perfluoroalkyl substance exposure and child adiposity at 8 years of age: The HOME study. *Obesity (Silver Spring, Md.)* 24(1):231-237. 10.1002/oby.21258.

8. REFERENCES

- Braun JM, Chen A, Romano ME, et al. 2016b. Supplemental material for: Prenatal perfluoroalkyl substance exposure and child adiposity at 8 years of age: The HOME study. [Obesity 24(1):231-237]. Obesity (Silver Spring, Md.) 24(1):231-237. <http://onlinelibrary.wiley.com/store/10.1002/oby.21258/asset/supinfo/oby21258-sup-0001-supinfo01.docx?v=1&s=cac722d8275d428f198a62d78041881f25813e38>.
- Braun JM, Kalkbrenner AE, Just AC, et al. 2014. Gestational exposure to endocrine-disrupting chemicals and reciprocal social, repetitive, and stereotypic behaviors in 4- and 5-year-old children: The HOME study. Environ Health Perspect 122(5):513-520. 10.1289/ehp.1307261.
- +Brewster DW, Birnbaum LS. 1989. The biochemical toxicity of perfluorodecanoic acid in the mouse is different from that of 2,3,7,8-tetrachlorodibenzo-p-dioxin. Toxicol Appl Pharmacol 99:544-554.
- Brochot C, Smith TJ, Bois FY. 2007. Development of a physiologically based toxicokinetic model for butadiene and four major metabolites in humans: Global sensitivity analysis for experimental design issues. Chem Biol Interact 167(3):168-183. 10.1016/j.cbi.2007.02.010.
- Buck RC, Franklin J, Berger U, et al. 2011. Perfluoroalkyl and polyfluoroalkyl substances in the environment: Terminology, classification, and origins. Integr Environ Assess Manag 7(4):513-541.
- Buck Louis GM, Chen Z, Schisterman EF, et al. 2015. Perfluorochemicals and human semen quality: The LIFE study. Environ Health Perspect 123(1):57-63. 10.1289/ehp.1307621.
- Buck Louis GM, Peterson CM, Chen Z, et al. 2012. Perfluorochemicals and endometriosis. The ENDO study. Epidemiology 23(6):799-805.
- Buist SCN, Klaassen CD. 2004. Rat and mouse differences in gender-predominant expression of organic anion transporter (OAT1-3; SLC22A6-9) mRNA levels. Drug Metab Dispos 32(6):620-625.
- Burns DC, Ellis DA, Li H, et al. 2008. Experimental pK_a determination for perfluorooctanoic acid (PFOA) and the potential impact of pK_a concentration dependence on laboratory-measured phenomena and environmental modeling. Environ Sci Technol 42(24):9283-9288.
- Buser MC, Scinicariello F. 2016. Perfluoroalkyl substances and food allergies in adolescents. Environ Int 88:74-79. 10.1016/j.envint.2015.12.020.
- +Butenhoff JL, Bjork JA, Chang SC, et al. 2012a. Toxicological evaluation of ammonium perfluorobutyrate in rats: Twenty-eight-day and ninety-day oral gavage studies. Reprod Toxicol 33(4):513-530.
- +Butenhoff JL, Chang S, Ehresman DJ, et al. 2009a. Evaluation of potential reproductive and developmental toxicity of potassium perfluorohexanesulfonate in Sprague Dawley rats. Reprod Toxicol 27:331-341.
- +Butenhoff JL, Chang SC, Olsen GW, et al. 2012b. Chronic dietary toxicity and carcinogenicity study with potassium perfluorooctanesulfonate in Sprague Dawley rats. Toxicology 293(1-3):1-15.
- +Butenhoff J, Costa G, Elcombe C, et al. 2002. Toxicity of ammonium perfluorooctanoate in male Cynomolgus monkeys after oral dosing for 6 months. Toxicol Sci 69(1):244-257.
- +Butenhoff JL, Ehresman DJ, Chang SC, et al. 2009b. Gestational and lactational exposure to potassium perfluorooctanesulfonate (K+PFOS) in rats: Developmental neurotoxicity. Reprod Toxicol 27(3-4):319-330.
- Butenhoff JL, Gaylor DW, Moore JA, et al. 2004a. Characterization of risk for general population exposure to perfluorooctanoate. Regul Toxicol Pharmacol 39(3):363-380.
- +Butenhoff JL, Kennedy GL, Frame SR, et al. 2004b. The reproductive toxicology of ammonium perfluorooctanoate (APFO) in the rat. Toxicology 196(1-2):95-116.
- Butenhoff JL, Kennedy GL, Hinderliter PM, et al. 2004c. Pharmacokinetics of perfluorooctanoate in Cynomolgus monkeys. Toxicol Sci 82:394-406.
- Butenhoff JL, Kennedy GL, Jung R, et al. 2014. Evaluation of perfluorooctanoate for potential genotoxicity. Toxicol Rep 1:252-270.
- Butenhoff JL, Pieterman E, Ehresman DJ, et al. 2012c. Distribution of perfluorooctanesulfonate and perfluorooctanoate into human plasma lipoprotein fractions. Toxicol Lett 210(3):360-365. 10.1016/j.toxlet.2012.02.013.

8. REFERENCES

- Butt CM, Mabury SA, Kwan M, et al. 2008. Spatial trends of perfluoroalkyl compounds in ringed seals (*Phoca hispida*) from the Canadian Arctic. *Environ Toxicol Chem* 27(3):542-553.
- Butt CM, Mabury SA, Muir DCG, et al. 2007a. Prevalence of long-chained perfluorinated carboxylates in seabirds from the Canadian Arctic between 1975 and 2004. *Environ Sci Technol* 41:3521-3528.
- Butt CM, Muir DCG, Stirling I, et al. 2007b. Rapid response of arctic ringed seals to changes in perfluoroalkyl production. *Environ Sci Technol* 41(1):42-49.
- Calafat AM, Kuklenyik Z, Caudill SP, et al. 2006a. Perfluorochemicals in pooled serum samples from United States residents in 2001 and 2002. *Environ Sci Technol* 40:2128-2134.
- Calafat AM, Kuklenyik Z, Reidy JA, et al. 2007a. Serum concentrations of 11 polyfluoroalkyl compounds in the U.S. population: Data from the National Health and Nutrition Examination Survey (NHANES) 1999-2000. *Environ Sci Technol* 41:2237-2242.
- Calafat AM, Needham LL, Kuklenyik Z, et al. 2006b. Perfluorinated chemicals in selected residents of the American continent. *Chemosphere* 63:490-496.
- Calafat AM, Wong L, Kuklenyik Z, et al. 2007b. Polyfluoroalkyl chemicals in the U.S. population: Data from the National Health and Nutrition Examination Survey (NHANES) 2003-2004 and comparisons with NHANES 1999-2000. *Environ Health Perspect* 115:1596-1602.
- Cariou R, Veyrand B, Yamada A, et al. 2015. Perfluoroalkyl acid (PFAA) levels and profiles in breast milk, maternal and cord serum of French women and their newborns. *Environ Int* 84:71-81.
- Carr CK, Watkins AM, Wolf CJ, et al. 2013. Testing for departures from additivity in mixtures of perfluoroalkyl acids (PFAAs). *Toxicology* 306:169-175. 10.1016/j.tox.2013.02.016.
- CAS. 2008. Registry. Columbus, OH: Chemical Abstracts Service. <http://stnweb.cas.org/>. March 14, 2008.
- +Case MT, York RG, Christian MS. 2001. Rat and rabbit oral developmental toxicology studies with two perfluorinated compounds. *Int J Toxicol* 20(2):101-109.
- Cattley RC, DeLuca J, Elcombe C, et al. 1998. Do peroxisome proliferating compounds pose a hepatocarcinogenic hazard to humans? *Regul Toxicol Pharmacol* 27:47-60.
- CDC. 2013. Fourth national report on human exposure to environmental chemicals. Updated tables, September 2013. U.S. Department of Health and Human Services, Centers for Disease Control and Prevention.
- CDC. 2015. Fourth national report on human exposure to environmental chemicals. February 2015. U.S. Department of Health and Human Services, Centers for Disease Control and Prevention. https://www.cdc.gov/biomonitoring/pdf/fourthreport_updatedtables_feb2015.pdf. May 25, 2017.
- CDC. 2018. Fourth national report on human exposure to environmental chemicals. Updated Tables, March 2018. Atlanta, GA: Centers for Disease Control and Prevention, Department of Health and Human Services. https://www.cdc.gov/exposurereport/pdf/FourthReport_UpdatedTables_Volume1_Mar2018.pdf. April 23, 2018.
- Celik A, Eke D, Ekinici SY, et al. 2013. The protective role of curcumin on perfluorooctane sulfonate-induced genotoxicity: Single cell gel electrophoresis and micronucleus test. *Food Chem Toxicol* 53:249-255.
- CEMN. 2008. CEMC focussing on ionizing surfactants. Canadian Environmental Modelling Network. <http://www.trentu.ca/academic/aminss/envmodel/cemn/NewsReports/CEMNnews200804.pdf>. June 24, 2008.
- Chan E, Burstyn I, Cherry N, et al. 2011. Perfluorinated acids and hypothyroxinemia in pregnant women. *Environ Res* 111(4):559-564.
- Chang ET, Adami H, Boffetta P, et al. 2014. A critical review of perfluorooctanoate and perfluorooctanesulfonate exposure and cancer risk in humans. *Crit Rev Toxicol* 44:1-81.
- Chang S, Das K, Ehresman DJ, et al. 2008a. Comparative pharmacokinetics of perfluorobutylate (PFBA) in rats, mice, monkeys, and humans and relevance to human exposure via drinking water. *Toxicol Sci* 104(1):40-53.

8. REFERENCES

- +Chang S, Ehresman DJ, Bjork JA, et al. 2009. Gestational and lactational exposure to potassium perfluorooctanesulfonate (K+PFOS) in rats: Toxicokinetics, thyroid hormone status, and related gene expression. *Reprod Toxicol* 27(3-4):387-399.
- Chang S, Noker PE, Gorman GS, et al. 2012. Comparative pharmacokinetics of perfluorooctanesulfonate (PFOS) in rats, mice, and monkeys. *Reprod Toxicol* 33(4):428-440.
- +Chang S, Thibodeaux JR, Eastvold ML, et al. 2008b. Thyroid hormone status and pituitary function in adult rats given oral doses of perfluorooctanesulfonate (PFOS). *Toxicology* 243:330-339.
- Château-Degat ML, Pereg D, Dallaire R, et al. 2010. Effects of perfluorooctanesulfonate exposure on plasma lipid levels in the Inuit population of Nunavik (Northern Quebec). *Environ Res* 110(7):710-717.
- ChemIDplus. 2008. Perfluoroalkyls. ChemIDplus. Bethesda, MD: U.S. National Library of Medicine. <http://sis.nlm.nih.gov/chemical.html>. July 10, 2008.
- ChemIDplus. 2017. Ammonium perfluorooctanoate. Bethesda, MD: ChemIDplus. U.S. National Library of Medicine. <http://sis.nlm.nih.gov/chemical.html>. December 22, 2017.
- Chen MH, Ha EH, Liao HF, et al. 2013. Perfluorinated compound levels in cord blood and neurodevelopment at 2 years of age. *Epidemiology* 24(6):800-808. 10.1097/EDE.0b013e3182a6dd46.
- Chen MH, Ha EH, Wen TW, et al. 2012a. Perfluorinated compounds in umbilical cord blood and adverse birth outcomes. *PLoS ONE* 7(8):e42474.
- +Chen T, Zhang L, Yue JQ, et al. 2012b. Prenatal PFOS exposure induces oxidative stress and apoptosis in the lung of rat off-spring. *Reprod Toxicol* 33(4):538-545.
- Chen YM, Guo LH. 2009. Fluorescence study on site-specific binding of perfluoroalkyl acids to human serum albumin. *Arch Toxicol* 83(3):255-261.
- +Cheng J, Fujimura M, Zhao W, et al. 2013. Neurobehavioral effects, c-Fos/Jun expression and tissue distribution in rat offspring prenatally co-exposed to MeHg and PFOA: PFOA impairs Hg retention. *Chemosphere* 91(6):758-764.
- Cheng W, Ng CA. 2017. A permeability-limited physiologically based pharmacokinetic (PBPK) model for perfluorooctanoic acid (PFOA) in male rats. *Environ Sci Technol* 51(17):9930-9939. 10.1021/acs.est.7b02602.
- Cheng X, Klaassen CD. 2008a. Critical role of PPAR- α in perfluorooctanoic acid- and perfluorodecanoic acid-induced downregulation of oatp uptake transporters in mouse livers. *Toxicol Sci* 106(1):37-45. 10.1093/toxsci/kfn161.
- Cheng X, Klaassen CD. 2008b. Perfluorocarboxylic acids induce cytochrome P450 enzymes in mouse liver through activation of PPAR-alpha and CAR transcription factors. *Toxicol Sci* 106(1):29-36. 10.1093/toxsci/kfn147.
- Chengelis CP, Kirkpatrick JB, Myers NR, et al. 2009. Comparison of the toxicokinetic behavior of perfluorohexanoic acid (PFHxA) and nonafluorobutane-1-sulfonic acid (PFBS) in *Cynomolgus* monkeys and rats. *Reprod Toxicol* 27:400-406.
- Christensen KY, Maisonet M, Rubin C, et al. 2011. Exposure to polyfluoroalkyl chemicals during pregnancy is not associated with offspring age at menarche in a contemporary British cohort. *Environ Int* 37(1):129-135.
- Christensen KY, Raymond M, Thompson BA, et al. 2016. Perfluoroalkyl substances in older male anglers in Wisconsin. *Environ Int* 91:312-318. 10.1016/j.envint.2016.03.012.
- Clara M, Gans O, Weiss S, et al. 2009. Perfluorinated alkylated substances in the aquatic environment: An Austrian case study. *Water Res* 43(18):4760-4768. 10.1016/j.watres.2009.08.004.
- Clarke BO, Smith SR. 2011. Review of 'emerging' organic contaminants in biosolids and assessment of international research priorities for the agricultural use of biosolids. *Environ Int* 37(1):226-247. 10.1016/j.envint.2010.06.004.
- Clewell HJ, Andersen ME. 1985. Risk assessment extrapolations and physiological modeling. *Toxicol Ind Health* 1(4):111-131.

8. REFERENCES

- Conder JM, Hoke RA, De Wolf W, et al. 2008. Are PFCAs bioaccumulative? A critical review and comparison with regulatory criteria and persistent lipophilic compounds. *Environ Sci Technol* 42(4):995-1003.
- Consonni D, Straif K, Symons JM, et al. 2013. Cancer risk among tetrafluoroethylene synthesis and polymerization workers. *Am J Epidemiol* 178(3):350-358.
- +Cook JC, Murray SM, Frame SR, et al. 1992. Induction of Leydig cell adenomas by ammonium perfluorooctanoate: A possible endocrine-related mechanism. *Toxicol Appl Pharmacol* 113(2):209-217.
- Corsini E, Luebke RW, Germolec DR, et al. 2014. Perfluorinated compounds: Emerging POPs with potential immunotoxicity. *Toxicol Lett* 230(2):263-270. 10.1016/j.toxlet.2014.01.038.
- Corton JC, Cunningham ML, Hummer BT, et al. 2014. Mode of action framework analysis for receptor-mediated toxicity: The peroxisome proliferator-activated receptor alpha (PPAR α) as a case study. *Crit Rev Toxicol* 4444(1):1-49. 10.3109/10408444.2013.835784.
- Costa G. 2004. Report on the meeting held on Friday 20th and Saturday 21st 2004 at the Inn at Montchanin Village (Wilmington, USA) with 3M and DuPont delegations. DuPont. Submitted to the U.S. Environmental Protection Agency. AR226-1866.
- Costa G, Sartori S, Consonni D. 2009. Thirty years of medical surveillance in perfluorooctanoic acid production workers. *J Occup Environ Med* 51(3):364-372.
- +Cui L, Zhou QF, Liao CY, et al. 2009. Studies on the toxicological effects of PFOA and PFOS on rats using histological observation and chemical analysis. *Arch Environ Contam Toxicol* 56(2):338-349.
- +Curran I, Hierlihy SL, Liston V, et al. 2008. Altered fatty acid homeostasis and related toxicologic sequelae in rats exposed to dietary potassium perfluorooctanesulfonate (PFOS). *J Toxicol Environ Health A* 71(23):1526-1541.
- Dai J, Li M, Jin Y, et al. 2006. Perfluorooctanesulfonate and perfluorooctanoate in red panda and giant panda from China. *Environ Sci Technol* 40:5647-5652.
- Dallaire R, Ayotte P, Pereg D, et al. 2009. Determinants of plasma concentrations of perfluorooctanesulfonate and brominated organic compounds in Nunavik Inuit adults (Canada). *Environ Sci Technol* 43(13):5130-5136.
- Dalsager L, Christensen N, Husby S, et al. 2016. Association between prenatal exposure to perfluorinated compounds and symptoms of infections at age 1-4 years among 359 children in the Odense Child Cohort. *Environ Int* 96:58-64.
- Darrow LA, Groth AC, Winquist A, et al. 2016. Modeled perfluorooctanoic acid (PFOA) exposure and liver function in a mid-Ohio Valley community. *Environ Health Perspect* [Advance publication]. 10.1289/ehp.1510391.
- Darrow LA, Howards PP, Winquist A, et al. 2014. PFOA and PFOS serum levels and miscarriage risk. *Epidemiology* 25(4):505-512. 10.1097/ede.000000000000103.
- Darrow LA, Stein CR, Steenland K. 2013. Serum perfluorooctanoic acid and perfluorooctane sulfonate concentrations in relation to birth outcomes in the Mid-Ohio Valley, 2005-2010. *Environ Health Perspect* 121(10):1207-1213.
- +Das KP, Grey BE, Zehr RD, et al. 2008. Effects of perfluorobutyrate exposure during pregnancy in the mouse. *Toxicol Sci* 105(1):173-181.
- +Das KP, Grey BE, Rosen MB, et al. 2015. Developmental toxicity of perfluorononanoic acid in mice. *Reprod Toxicol* 51:133-144. 10.1016/j.reprotox.2014.12.012.
- Das KP, Wood CR, Lin MT, et al. 2017. Perfluoroalkyl acids-induced liver steatosis: Effects on genes controlling lipid homeostasis. *Toxicology* 378:37-52. 10.1016/j.tox.2016.12.007.
- Dauchy X, Boiteux V, Rosin C, et al. 2012. Relationship between industrial discharges and contamination of raw water resources by perfluorinated compounds. Part I: Case study of a fluoropolymer manufacturing plant. *Bull Environ Contam Toxicol* 89(3):525-530. 10.1007/s00128-012-0704-x.
- Davis KL, Aucoin MD, Larsen BS, et al. 2007. Transport of ammonium perfluorooctanoate in environmental media near a fluoropolymer manufacturing facility. *Chemosphere* 67:2011-2019.

8. REFERENCES

- de Cock M, de Boer MR, Lamoree M, et al. 2014. First year growth in relation to prenatal exposure to endocrine disruptors - a Dutch prospective cohort study. *Int J Environ Res Public Health* 11(7):7001-7021. 10.3390/ijerph110707001.
- Delinsky AD, Strynar MJ, McCann PJ, et al. 2010. Geographical distribution of perfluorinated compounds in fish from Minnesota lakes and rivers. *Environ Sci Technol* 44(7):2549-2554. 10.1021/es903777s.
- Delinsky AD, Strynar MJ, Nakayama SF, et al. 2009. Determination of ten perfluorinated compounds in bluegill sunfish (*Lepomis macrochirus*) filets. *Environ Res* 109:975-984.
- D'eon JC, Mabury SA. 2007. Production of perfluorinated carboxylic acids (PFCAs) from the biotransformation of polyfluoroalkyl phosphate surfactants (PAPS): Exploring routes of human contamination. *Environ Sci Technol* 41(13):4799-4805.
- D'eon JC, Crozier PW, Furdui VI, et al. 2009. Observation of a commercial fluorinated material, the polyfluoroalkyl phosphoric acid diesters, in human sera, wastewater treatment plant sludge, and paper fibers. *Environ Sci Technol* 43(12):4589-4594.
- D'eon JC, Hurley MD, Wallington TJ, et al. 2006. Atmospheric chemistry of n-methyl perfluorobutane sulfonamidoethanol, C₄F₉SO₂N(CH₃)CH₂CH₂OH: Kinetics and mechanism of reaction with OH. *Environ Sci Technol* 40:1862-1868.
- De Silva AO, Benskin JP, Martin LJ, et al. 2009. Disposition of perfluorinated acid isomers in Sprague-Dawley rats. Part 2: Subchronic dose. *Environ Toxicol Chem* 28(3):555-567.
- De Silva AO, Mabury SA. 2006. Isomer distribution of perfluorocarboxylates in human blood: Potential correlation to source. *Environ Sci Technol* 40:2903-2909.
- De Silva AO, Spencer C, Scott BF, et al. 2011. Detection of a cyclic perfluorinated acid, perfluoroethylcyclohexane sulfonate, in the Great Lakes of North America. *Environ Sci Technol* 45:8060-8066.
- de Vos MG, Huijbregts MAJ, van den Heuvel-Greve MJ, et al. 2008. Accumulation of perfluorooctane sulfonate (PFOS) in the food chain of the Western Scheldt estuary: Comparing field measurements with kinetic modeling. *Chemosphere* 70:1766-1773.
- +DeWitt JC, Copeland CB, Luebke RW. 2009. Suppression of humoral immunity by perfluorooctanoic acid is independent of elevated serum corticosterone concentration in mice. *Toxicol Sci* 109:106-112.
- +DeWitt JC, Copeland CB, Strynar MJ, et al. 2008. Perfluorooctanoic acid-induced immunomodulation in adult C57BL/6J or C57BL/6N female mice. *Environ Health Perspect* 116(5):644-650.
- DeWitt JC, Peden-Adams MM, Keller JM, et al. 2012. Immunotoxicity of perfluorinated compounds: Recent developments. *Toxicol Pathol* 40(2):300-311. 10.1177/0192623311428473.
- +DeWitt JC, Williams WC, Creech NJ, et al. 2016. Suppression of antigen-specific antibody responses in mice exposed to perfluorooctanoic acid: Role of PPARalpha and T- and B-cell targeting. *J Immunotoxicol* 13(1):38-45. 10.3109/1547691x.2014.996682.
- Dhingra R, Darrow LA, Klein M, et al. 2016a. Perfluorooctanoic acid exposure and natural menopause: A longitudinal study in a community cohort. *Environ Res* 146:323-330. 10.1016/j.envres.2015.12.037.
- Dhingra R, Lally C, Darrow LA, et al. 2016b. Perfluorooctanoic acid and chronic kidney disease: Longitudinal analysis of a Mid-Ohio Valley community. *Environ Res* 145:85-92. 10.1016/j.envres.2015.11.018.
- Dinglasan-Panlilio MJA, Mabury SA. 2006. Significant residual fluorinated alcohols present in various fluorinated materials. *Environ Sci Technol* 40:1447-1453.
- Dixon D, Reed CE, Moore AB, et al. 2012. Histopathologic changes in the uterus, cervix and vagina of immature CD-1 mice exposed to low doses of perfluorooctanoic acid (PFOA) in a uterotrophic assay. *Reprod Toxicol* 33(4):506-512. 10.1016/j.reprotox.2011.10.011.
- Dobraca D, Israel L, McNeel S, et al. 2015. Biomonitoring in California firefighters: Metals and perfluorinated chemicals. *J Occup Environ Med* 57(1):88-97. 10.1097/jom.0000000000000307.

8. REFERENCES

- DOE. 2016a. Table 3: Protective Action Criteria (PAC) Rev. 29 based on applicable 60-minute AEGLs, ERPGs, or TEELs. The chemicals are listed by CASRN. May 2016. Oak Ridge, TN: U.S. Department of Energy. https://sp.eota.energy.gov/pac/teel/Revision_29_Table3.pdf. February 28, 2017.
- DOE. 2016b. Protective Action Criteria (PAC) with AEGLs, ERPGs, & TEELs: Rev. 29 for Chemicals of Concern - May 2016. Oak Ridge, TN: U.S. Department of Energy. <https://energy.gov/ehss/protective-action-criteria-pac-aegls-erpgs-teels-rev-29-chemicals-concern-may-2016>. February 28, 2017.
- Domingo JL, Ericson-Jogsten I, Perello G, et al. 2012a. Human exposure to perfluorinated compounds in Catalonia, Spain: Contribution of drinking water and fish and shellfish. *J Agric Food Chem* 60(17):4408-4415.
- Domingo JL, Jogsten IE, Eriksson U, et al. 2012b. Human dietary exposure to perfluoroalkyl substances in Catalonia, Spain. Temporal trend. *Food Chem* 135:1575-1582.
- Donauer S, Chen A, Xu Y, et al. 2015. Prenatal exposure to polybrominated diphenyl ethers and polyfluoroalkyl chemicals and infant neurobehavior. *J Pediatr* 166(3):736-742. 10.1016/j.jpeds.2014.11.021.
- +Dong GH, Liu MM, Wang D, et al. 2011. Sub-chronic effect of perfluorooctanesulfonate (PFOS) on the balance of type 1 and type 2 cytokine in adult C57BL/6 mice. *Arch Toxicol* 85(10):1235-1244.
- Dong GH, Tung KY, Tsai CH, et al. 2013. Serum polyfluoroalkyl concentrations, asthma outcomes, and immunological markers in a case-control study of Taiwanese children. *Environ Health Perspect* 121(4):507-513.
- +Dong GH, Zhang YH, Zheng L, et al. 2009. Chronic effects of perfluorooctanesulfonate exposure on immunotoxicity in adult male C57BL/6 mice. *Arch Toxicol* 83(9):805-815.
- DRBC. 2013. Contaminants of emerging concern in the tidal Delaware River: Pilot monitoring survey 2007-2009. Delaware River Basin Commission. <http://www.nj.gov/drbc/library/documents/contaminants-of-emerging-concernAug2013rev.pdf>. July 6, 2017.
- Ducatman AM, Zhang J, Fan H. 2015a. Letter to the editor. (Prostate-specific antigen and perfluoroalkyl acids in the C8 health study population. *J Occup Environ Med* 57(1):111-114). *J Occup Environ Med* 57(6):e61. 10.1097/jom.0000000000000470.
- Ducatman A, Zhang J, Fan H. 2015b. Prostate-specific antigen and perfluoroalkyl acids in the C8 health study population. *J Occup Environ Med* 57(1):111-114. 10.1097/jom.0000000000000319.
- DuPont. 2008. Information on PFOA. http://repanet.de/PFOA2/en_US/index.html. April 07, 2008.
- DWQI. 2015. Maximum contaminant level recommendation for perfluorononanoic acid in drinking water. Trenton, NJ: New Jersey Drinking Water Quality Institute. <http://www.nj.gov/dep/watersupply/pdf/pfna-recommend-final.pdf>. December 18, 2017.
- DWQI. 2017a. Maximum contaminant level recommendation for perfluorooctanoic acid in drinking water. Trenton, NJ: New Jersey Drinking Water Quality Institute. <http://www.nj.gov/dep/watersupply/pdf/pfoa-recommend.pdf>. December 18, 2017.
- DWQI. 2017b. Public review draft: Perfluorooctane sulfonate (PFOS) (CAS #: 1763-23-1; Chemical Formula: C₈HF₁₇O₃S). Health-based maximum contaminant level support document. Trenton, NJ: Health Effects Subcommittee, New Jersey Drinking Water Quality Institute. <http://www.nj.gov/dep/watersupply/pdf/dwqi-pfos-mcl-draft.pdf>. December 18, 2017.
- Eggen T, Moeder M, Arukwe A. 2010. Municipal landfill leachates: A significant source for new and emerging pollutants. *Sci Total Environ* 408:5147-5157.
- Ehresman DJ, Froehlich JW, Olsen GW, et al. 2007. Comparison of human whole blood, plasma, and serum matrices for the determination of perfluorooctanesulfonate (PFOS), perfluorooctanoate (PFOA), and other fluorochemicals. *Environ Res* 103:176-184.
- Eke D, Celik A. 2016. Curcumin prevents perfluorooctane sulfonate-induced genotoxicity and oxidative DNA damage in rat peripheral blood. *Drug Chem Toxicol* 39(1):97-103. 10.3109/01480545.2015.1041601.

8. REFERENCES

- +Elcombe CR, Elcombe BM, Foster JR, et al. 2010. Hepatocellular hypertrophy and cell proliferation in Sprague-Dawley rats following dietary exposure to ammonium perfluorooctanoate occurs through increased activation of the xenosensor nuclear receptors PPAR α and CAR/PXR. *Arch Toxicol* 84(10):787-798.
- +Elcombe CR, Elcombe BM, Foster JR, et al. 2012b. Evaluation of hepatic and thyroid responses in male Sprague Dawley rats for up to eighty-four days following seven days of dietary exposure to potassium perfluorooctanesulfonate. *Toxicology* 293(1-3):30-40.
- +Elcombe CR, Elcombe BM, Foster JR, et al. 2012a. Hepatocellular hypertrophy and cell proliferation in Sprague-Dawley rats from dietary exposure to potassium perfluorooctanesulfonate results from increased expression of xenosensor nuclear receptors PPAR α and CAR/PXR. *Toxicology* 293(1-3):16-29.
- Eldasher LM, Wen X, Little MS, et al. 2013. Hepatic and renal Bcrp transporter expression in mice treated with perfluorooctanoic acid. *Toxicology* 306:108-113.
- Ellis DA, Martin JW, De Silva AO, et al. 2004. Degradation of fluorotelomer alcohols: A likely atmospheric source of perfluorinated carboxylic acids. *Environ Sci Technol* 27:3316-3321.
- Emmett EA, Shofer FS, Zhang H, et al. 2006a. Community exposure to perfluorooctanoate: Relationships between serum concentrations and exposure sources. *J Occup Environ Med* 48:759-770.
- Emmett EA, Zhang H, Shofer FS, et al. 2006b. Community exposure to perfluorooctanoate: Relationships between serum levels and certain health parameters. *J Occup Environ Med* 48(8):771-779.
- Emmett EA, Zhang H, Shofer FS, et al. 2009. Development and successful application of a "community-first" communication model for community-based environmental health research. *J Occup Environ Med* 51(2):146-156.
- EPA. 1988. Recommendations for and documentation of biological values for use in risk assessment. Washington, DC: U.S. Environmental Protection Agency. PB88179874.
- EPA. 2002. Perfluoroalkyl sulfonates; significant new use rule. U.S. Environmental Protection Agency. *Fed Regist* 67(236):72854-72867.
- EPA. 2005a. Draft risk assessment of the potential human health effects associated with exposure to perfluorooctanoic acid and its salts. U.S. Environmental Protection Agency. <http://www.epa.gov/opptintr/pfoa/pubs/pfoarisk.pdf>. June 26, 2007.
- EPA. 2005b. Toxic chemical release inventory reporting forms and instructions: Revised 2004 version. Section 313 of the Emergency Planning and Community Right-to-Know Act (Title III of the Superfund Amendments and Reauthorization Act of 1986). U.S. Environmental Protection Agency. Office of Environmental Information. EPA260B05001.
- EPA. 2005c. Guidelines for carcinogen risk assessment. Washington, DC: U.S. Environmental Protection Agency. EPA630P03001F. http://www.epa.gov/raf/publications/pdfs/CANCER_GUIDELINES_FINAL_3-25-05.PDF. December 10, 2014.
- EPA. 2006. SAB review of EPA's draft risk assessment of potential human health effects associated with PFOA and its salts. U.S. Environmental Protection Agency. [http://yosemite.epa.gov/sab/sabproduct.nsf/A3C83648E77252828525717F004B9099/\\$File/sab_06_006.pdf](http://yosemite.epa.gov/sab/sabproduct.nsf/A3C83648E77252828525717F004B9099/$File/sab_06_006.pdf). April 24, 2008.
- EPA. 2007a. Perfluoroalkyl sulfonates; significant new use rule. U.S. Environmental Protection Agency. *Fed Regist* 72:57222-57235.
- EPA. 2007b. Quarterly MOU status report #6: Phase II monitoring/sampling work plan, DuPont Washington Works (PFOA site-related environmental assessment program), Appendices 3.1 through 5.1. U.S. Environmental Protection Agency. EPA-HQ-OPPT-2004-0113-0242.1. <http://www.regulations.gov/fdmspublic/component/main?main=DocketDetail&d=EPA-HQ-OPPT-2004-0113>. May 18, 2009.

8. REFERENCES

- EPA. 2008a. Perfluorooctanoic acid (PFOA) and fluorinated telomers. U.S. Environmental Protection Agency. <http://www.epa.gov/oppt/pfoa/>. May 29, 2008.
- EPA. 2008b. Non-confidential IUR production volume information. Inventory updating reporting. U.S. Environmental Protection Agency. <http://www.epa.gov/opptintr/iur/tools/data/2002-vol.htm>. July 09, 2008.
- EPA. 2008c. Perfluoroalkyls. Substance registry system. U.S. Environmental Protection Agency. <http://www.epa.gov/srs/>. July 10, 2008.
- EPA. 2008d. Quarterly MOU status report #10: Phase II monitoring/sampling work plan, DuPont Washington Works (PFOA site-related environmental assessment program), text, tables 4.1 through 5.10. U.S. Environmental Protection Agency. EPA-HQ-OPPT-2004-0113-0430. <http://www.regulations.gov/fdmspublic/component/main?main=DocketDetail&d=EPA-HQ-OPPT-2004-0113>. May 18, 2009.
- EPA. 2009a. PFOS chromium electroplater study. Cleveland, OH: U.S. Environmental Protection Agency- Region 5.
- EPA. 2009b. Perfluorocarboxylic acid content in 116 articles of commerce. Research Triangle Park, NC: U.S. Environmental Protection Agency, National Risk Management Research Laboratory, Office of Research and Development. EPA600R09033.
- EPA. 2009c. Method 537. Determination of selected perfluorinated alkyl acids in drinking water by solid phase extraction and liquid chromatography/tandem mass spectrometry (LC/MS/MS). U.S. Environmental Protection Agency. http://www.epa.gov/microbes/documents/Method%20537_FINAL_rev1.1.pdf. May 5, 2014.
- EPA. 2009d. National primary drinking water regulations. Washington, DC: Office of Ground Water and Drinking Water, U.S. Environmental Protection Agency. EPA816F090004. https://www.epa.gov/sites/production/files/2016-06/documents/npwdr_complete_table.pdf. February 28, 2017.
- EPA. 2010. Quarterly MOU Status Report #17. Phase II. Monitoring/sampling work plan. DuPont Washington Works (OPPT-2004-0113 PFOA site-related environmental assessment program). U.S. Environmental Protection Agency. Project No: 18984356.05013.
- EPA. 2014. Health effects document for perfluorooctanoic acid (PFOA). U.S. Environmental Protection Agency. EPA822R14001. <https://nepis.epa.gov/Exe/ZyPURL.cgi?Dockey=P100IRZ1.txt>. December 21, 2017.
- EPA. 2015. Long-chain perfluoroalkyl carboxylate and perfluoroalkyl sulfonate chemical substances: Significant new use rule. Fed Regist 80(13):2885-2898.
- EPA. 2016a. 2010/2015 PFOA Stewardship Program- 2014 annual progress reports. U.S. Environmental Protection Agency. <https://www.epa.gov/assessing-and-managing-chemicals-under-tsca/20102015-pfoa-stewardship-program-2014-annual-progress#summary>. August 08, 2016.
- EPA. 2016b. Compiled AEGL values. Acute Exposure Guideline Levels (AEGLs) Values. U.S. Environmental Protection Agency. https://www.epa.gov/sites/production/files/2016-03/documents/compiled_aegl_update_.pdf. February 28, 2017.
- EPA. 2016c. The Third Unregulated Contaminant Monitoring Rule (UCMR 3): Data summary, July 2016. U.S. Environmental Protection Agency, Office of Water.
- EPA. 2016d. Chemical Data Access Tool (CDAT). U.S. Environmental Protection Agency. https://java.epa.gov/oppt_chemical_search/. December 09, 2016.
- EPA. 2016e. Drinking water health advisory for perfluorooctanoic acid (PFOA). U.S. Environmental Protection Agency. https://www.epa.gov/sites/production/files/2016-05/documents/pfoa_health_advisory_final-plain.pdf. March 3, 2017.
- EPA. 2016f. Drinking water health advisory for perfluorooctane sulfonate (PFOS). U.S. Environmental Protection Agency. https://www.epa.gov/sites/production/files/2016-05/documents/pfos_health_advisory_final-plain.pdf. March 3, 2017.
- EPA. 2016g. Toxic chemical release inventory reporting forms and instructions: Revised 2016 version. Section 313 of the Emergency Planning and Community Right-to-Know Act (Title III of the

8. REFERENCES

- Superfund Amendments and Reauthorization Act of 1986). U.S. Environmental Protection Agency, Office of Environmental Information. EPA740B16001. https://ofmpub.epa.gov/apex/guideme_ext/guideme_ext/r/files/static/v3321/rfi/RY_2016_RFI.pdf. July 5, 2017.
- EPA. 2016h. Health effects support document for perfluorooctanoic acid (PFOA). U.S. Environmental Protection Agency. EPA822R16003. https://www.epa.gov/sites/production/files/2016-05/documents/pfoa_hesd_final-plain.pdf. July 6, 2017.
- EPA. 2016i. Health effects support document for perfluorooctane sulfate (PFOS). U.S. Environmental Protection Agency. EPA822R16002. https://www.epa.gov/sites/production/files/2016-05/documents/pfos_hesd_final_508.pdf. July 6, 2017.
- EPA. 2016j. Lifetime health advisories and health effects support documents for perfluorooctanoic acid and perfluorooctane sulfonates. Federal Register. U.S. Environmental Protection Agency. Vol. 81 FR 33250 (May 25, 2016). <https://www.epa.gov/sites/production/files/2016-05/documents/2016-12361.pdf>. December 18, 2017.
- +Era S, Harada KH, Toyoshima M, et al. 2009. Cleft palate caused by perfluorooctane sulfonate is caused mainly by extrinsic factors. *Toxicology* 256(1-2):42-47.
- EPA. 2017. The third Unregulated Contaminant Monitoring Rule (UCMR 3): Data summary, January 2017. U.S. Environmental Protection Agency. <https://www.epa.gov/sites/production/files/2017-02/documents/ucmr3-data-summary-january-2017.pdf>. July 6, 2017.
- Ericson I, Domingo JL, Nadal M, et al. 2009. Levels of perfluorinated chemicals in municipal drinking water from Catalonia, Spain: Public health implications. *Arch Environ Contam Toxicol* 57(4):631-638. 10.1007/s00244-009-9375-y.
- Ericson I, Gómez M, Nadal M, et al. 2007. Perfluorinated chemicals in blood of residents in Catalonia (Spain) in relation to age and gender: A pilot study. *Environ Int* 33:616-623.
- Eriksen KT, Raaschou-Nielsen O, McLaughlin JK, et al. 2013. Association between plasma PFOA and PFOS levels and total cholesterol in a middle-aged Danish population. *PLoS ONE* 8(2):e56969.
- Eriksen KT, Raaschou-Nielsen O, Sorensen M, et al. 2010. Genotoxic potential of the perfluorinated chemicals PFOA, PFOS, PFBS, PFNA and PFHxA in human HepG2 cells. *Mutat Res* 700(1-2):39-43. 10.1016/j.mrgentox.2010.04.024.
- Eriksen KT, Sorensen M, McLaughlin JK, et al. 2009. Perfluorooctanoate and perfluorooctanesulfonate plasma levels and risk of cancer in the general Danish population. *J Natl Cancer Inst* 101(8):605-609.
- Fábrega F, Kumar V, Schuhmacher M, et al. 2014. PBPK modeling for PFOS and PFOA: Validation with human experimental data. *Toxicol Lett* 230(2):244-251.
- Fábrega F, Nadal M, Schuhmacher M, et al. 2016. Influence of the uncertainty in the validation of PBPK models: A case-study for PFOS and PFOA. *Regul Toxicol Pharmacol* 77:230-239. 10.1016/j.yrtph.2016.03.009
- +Fairley KJ, Purdy R, Kearns S, et al. 2007. Exposure to the immunosuppressant, perfluorooctanoic acid, enhances the murine IgE and airway hyperreactivity response to ovalbumin. *Toxicol Sci* 97(2):375-383.
- +Fang X, Feng Y, Shi Z, et al. 2009. Alterations of cytokines and MAPK signaling pathways are related to the immunotoxic effect of perfluorononanoic acid. *Toxicol Sci* 108(2):367-376. 10.1093/toxsci/kfp019.
- +Fang X, Feng Y, Wang J, et al. 2010. Perfluorononanoic acid-induced apoptosis in rat spleen involves oxidative stress and the activation of caspase-independent death pathway. *Toxicology* 267(1-3):54-59. 10.1016/j.tox.2009.10.020.
- +Fang X, Gao G, Xue H, et al. 2012a. Exposure of perfluorononanoic acid suppresses the hepatic insulin signal pathway and increases serum glucose in rats. *Toxicology* 294(2-3):109-115.
- +Fang X, Gao G, Xue H, et al. 2012b. *In vitro* and *in vivo* studies of the toxic effects of perfluorononanoic acid on rat hepatocytes and Kupffer cells. *Environ Toxicol Pharmacol* 34(2):484-494.

8. REFERENCES

- +Fang X, Zhang L, Feng Y, et al. 2008. Immunotoxic effects of perfluorononanoic acid on BALB/c mice. *Toxicol Sci* 105(2):312-321.
- Fasano WJ, Carpenter SC, Gannon SA, et al. 2006. Absorption, distribution, metabolism, and elimination of 8-2 fluorotelomer alcohol in the rat. *Toxicol Sci* 91(2):341-355.
- Fasano WJ, Kennedy GL, Szostek B, et al. 2005. Penetration of ammonium perfluorooctanoate through rat and human skin *in vitro*. *Drug Chem Toxicol* 28(1):79-90.
- FDA. 2013. Everything added to food in the United States (EAFUS). Washington, DC: U.S. Food and Drug Administration. <http://www.accessdata.fda.gov/scripts/fcn/fcnavigation.cfm?rpt=eafuslisting>. February 28, 2017.
- Fei C, Olsen J. 2011. Prenatal exposure to perfluorinated chemicals and behavioral or coordination problems at age 7 years. *Environ Health Perspect* 119(4):573-578.
- Fei C, McLaughlin JK, Lipworth L, et al. 2009. Maternal levels of perfluorinated chemicals and subfecundity. *Hum Reprod* 24(5):1200-1205.
- Fei C, McLaughlin JK, Lipworth L, et al. 2008b. Prenatal exposure to perfluorooctanoate (PFOA) and perfluorooctanesulfonate (PFOS) and maternally reported developmental milestones in infancy. *Environ Health Perspect* 116(10):1391-1395.
- Fei C, McLaughlin JK, Tarone RE, et al. 2007. Perfluorinated chemicals and fetal growth: A study within the Danish National Birth Cohort. *Environ Health Perspect* 115:1677-1682.
- Fei C, McLaughlin JK, Tarone RE, et al. 2008a. Fetal growth indicators and perfluorinated chemicals: A study in the Danish National Birth Cohort. *Am J Epidemiol* 168(1):66-72.
- Fei C, McLaughlin JK, Lipworth L, et al. 2010. Prenatal exposure to PFOA and PFOS and risk of hospitalization for infectious diseases in early childhood. *Environ Res* 110(8):773-777. 10.1016/j.envres.2010.08.004.
- Fei C, Weinberg CR, Olsen J. 2012. Commentary: Perfluorinated chemicals and time to pregnancy: A link based on reverse causation? *Epidemiology* 23(2):264-266.
- Feng Y, Fang X, Shi Z, et al. 2010. Effects of PFNA exposure on expression of junction-associated molecules and secretory function in rat Sertoli cells. *Reprod Toxicol* 30(3):429-437. 10.1016/j.reprotox.2010.05.010.
- Feng Y, Shi Z, Fang X, et al. 2009. Perfluorononanoic acid induces apoptosis involving the Fas death receptor signaling pathway in rat testis. *Toxicol Lett* 190(2):224-230. 10.1016/j.toxlet.2009.07.020.
- Fenton SE, Reiner JL, Nakayama SF, et al. 2009. Analysis of PFOA in dosed CD-1 mice. Part 2. Disposition of PFOA in tissues and fluids from pregnant and lactating mice and their pups. *Reprod Toxicol* 27(3-4):365-372.
- Fernández Freire P, Pérez Martin JM, Herrero O, et al. 2008. *In vitro* assessment of the cytotoxic and mutagenic potential of perfluorooctanoic acid. *Toxicol in Vitro* 22:1228-1233.
- Filgo AJ, Quist EM, Hoenerhoff MJ, et al. 2015a. Perfluorooctanoic Acid (PFOA)-induced liver lesions in two strains of mice following developmental exposures: PPARalpha is not required. *Toxicol Pathol* 43(4):558-568. 10.1177/0192623314558463.
- Filgo AJ, Quist EM, Hoenerhoff MJ, et al. 2015b. Supplemental data to perfluorooctanoic acid (PFOA)-induced liver lesions in two strains of mice following developmental exposures: PPARalpha is not required. [Toxicol Pathol 43(4):558-568]. *Toxicol Pathol* 10.1177/0192623314558463.
- Fisher M, Arbuckle TE, Wade M, et al. 2013. Do perfluoroalkyl substances affect metabolic function and plasma lipids? Analysis of the 2007-2009, Canadian Health Measures Survey (CHMS) Cycle 1. *Environ Res* 121:95-103.
- Fisher M, Arbuckle TE, Liang CL, et al. 2016. Concentrations of persistent organic pollutants in maternal and cord blood from the maternal-infant research on environmental chemicals (MIREC) cohort study. *Environ Health* 15(1):59.
- Fitz-Simon N, Fletcher T, Luster MI, et al. 2013. Reductions in serum lipids with a 4-year decline in serum perfluorooctanoic acid and perfluorooctanesulfonic acid. *Epidemiology* 24(4):569-576.

8. REFERENCES

- Florentin A, Deblonde T, Diguio N, et al. 2011. Impacts of two perfluorinated compounds (PFOS and PFOA) on human hepatoma cells: Cytotoxicity but no genotoxicity? *Int J Hyg Environ Health* 214(6):493-499.
- Food Standards Agency. 2006. FSIS 11/06. Fluorinated chemicals: UK dietary intakes. Food Standards Agency. <http://www.food.gov.uk/multimedia/pdfs/fsis1106.pdf>. June 28, 2008.
- Foreman JE, Chang SC, Ehresman DJ, et al. 2009. Differential hepatic effects of perfluorobutylate mediated by mouse and human PPAR- α . *Toxicol Sci* 110(1):204-211. 10.1093/toxsci/kfp077.
- Forns J, Iszatt N, White RA, et al. 2015. Perfluoroalkyl substances measured in breast milk and child neuropsychological development in a Norwegian birth cohort study. *Environ Int* 83:176-182.
- Franko J, Meade BJ, Frasch HF, et al. 2012. Dermal penetration potential of perfluorooctanoic acid (PFOA) in human and mouse skin. *J Toxicol Environ Health A* 75(1):50-62.
- Frisbee SJ, Brooks AP, Jr., Maher A, et al. 2009. The C8 health project: Design, methods, and participants. *Environ Health Perspect* 117(12):1873-1882.
- Frisbee SJ, Shankar A, Knox SS, et al. 2010. Perfluorooctanoic acid, perfluorooctanesulfonate, and serum lipids in children and adolescents: Results from the C8 Health Project. *Arch Pediatr Adolesc Med* 164(9):860-869.
- Fromme H, Midasch O, Twardella D, et al. 2007a. Occurrence of perfluorinated substances in an adult German population in southern Bavaria. *Int Arch Occup Environ Health* 80:313-319.
- Fromme H, Mosch C, Morovitz M, et al. 2010. Pre- and postnatal exposure to perfluorinated compounds (PFCs). *Environ Sci Technol* 44(18):7123-7129.
- Fromme H, Schlummer M, Moller A, et al. 2007b. Exposure of an adult population to perfluorinated substances using duplicate diet portions and biomonitoring data. *Environ Sci Technol* 41:7928-7933.
- Fromme H, Tittlemier SA, Volkel W, et al. 2009. Perfluorinated compounds-exposure assessment for the general population in western countries. *Int J Hyg Environ Health* 212(3):239-270.
- Fu J, Gao Y, Wang T, et al. 2015. Elevated levels of perfluoroalkyl acids in family members of occupationally exposed workers: The importance of dust transfer. *Scientific reports* 5:9313. 10.1038/srep09313.
- Fu Y, Wang T, Fu Q, et al. 2014a. Associations between serum concentrations of perfluoroalkyl acids and serum lipid levels in a Chinese population. *Ecotoxicol Environ Saf* 106:246-252. 10.1016/j.ecoenv.2014.04.039.
- Fu Y, Wang T, Wang P, et al. 2014b. Effects of age, gender and region on serum concentrations of perfluorinated compounds in general population of Henan, China. *Chemosphere* 110:104-110. 10.1016/j.chemosphere.2014.02.020.
- +Fuentes S, Colomina MT, Rodriguez J, et al. 2006. Interactions in developmental toxicology: Concurrent exposure to perfluorooctane sulfonate (PFOS) and stress in pregnant mice. *Toxicol Lett* 164(1):81-89.
- Fuentes S, Colomina MT, Vicens P, et al. 2007a. Influence of maternal restraint stress on the long-lasting effects induced by prenatal exposure to perfluorooctane sulfonate (PFOS) in mice. *Toxicol Lett* 171:162-170.
- Fuentes S, Colomina MT, Vicens P, et al. 2007b. Concurrent exposure to perfluoroactane sulfonate and restraint stress during pregnancy in mice: Effects on postnatal development and behavior of the offspring. *Toxicol Sci* 98:589-598.
- +Fuentes S, Vicens P, Colomina MT, et al. 2007c. Behavioral effects in adult mice exposed to perfluorooctane sulfonate (PFOS). *Toxicology* 242:123-129.
- Fujii Y, Harada KH, Koizumi A. 2013. Occurrence of perfluorinated carboxylic acids (PFCAs) in personal care products and compounding agents. *Chemosphere* 93(3):538-544.
- Fujii Y, Niisoe T, Harada KH, et al. 2015a. Toxicokinetics of perfluoroalkyl carboxylic acids with different carbon chain lengths in mice and humans. *J Occup Health* 57(1):1-12. 10.1539/joh.14-0136-OA.

8. REFERENCES

- Fujii Y, Niisoe T, Harada KH, et al. 2015b. Supplemental materials: Toxicokinetics of perfluoroalkyl carboxylic acids with different carbon chain lengths in mice and humans. *J Occup Health* 57(1):1-12.
- Fujii Y, Yan J, Harada KH, et al. 2012. Levels and profiles of long-chain perfluorinated carboxylic acids in human breast milk and infant formulas in East Asia. *Chemosphere* 86(3):315-321.
- Furdui F, Stock N, Ellis DA, et al. 2007. Spatial distribution of perfluoroalkyl contaminants in lake trout from the Great Lakes. *Environ Sci Technol* 41:1554-1559.
- Gallo V, Leonardi G, Brayne C, et al. 2013. Serum perfluoroalkyl acids concentrations and memory impairment in a large cross-sectional study. *BMJ Open* 3(6):e002414.
- Gallo V, Leonardi G, Genser B, et al. 2012. Serum perfluorooctanoate (PFOA) and perfluorooctane sulfonate (PFOS) concentrations and liver function biomarkers in a population with elevated PFOA exposure. *Environ Health Perspect* 120(5):655-660.
- Gao B, He X, Liu W, et al. 2015. Distribution of perfluoroalkyl compounds in rats: Indication for using hair as bioindicator of exposure. *J Expo Sci Environ Epidemiol* 25(6):632-638.
- Gauthier SA, Mabury SA. 2005. Aqueous photolysis of 8:2 fluorotelomer alcohol. *Environ Toxicol Chem* 24(8):1837-1846.
- Geiger SD, Xiao J, Shankar A. 2014a. No association between perfluoroalkyl chemicals and hypertension in children. *Integrated blood pressure control* 7:1-7. 10.2147/ibpc.s47660.
- Geiger SD, Xiao J, Ducatman A, et al. 2014b. The association between PFOA, PFOS and serum lipid levels in adolescents. *Chemosphere* 98:78-83. 10.1016/j.chemosphere.2013.10.005.
- Geiger SD, Xiao J, Shankar A. 2013. Positive association between perfluoroalkyl chemicals and hyperuricemia in children. *Am J Epidemiol* 177(11):1255-1262.
- Gellrich V, Brunn H, Stahl T. 2013. Perfluoroalkyl and polyfluoroalkyl substances (PFASs) in mineral water and tap water. *J Environ Sci Health A Tox Hazard Subst Environ Eng* 48(2):129-135. 10.1080/10934529.2013.719431.
- Genius SJ, Beesoon S, Birkholz D. 2013. Biomonitoring and elimination of perfluorinated compounds and polychlorinated biphenyls through perspiration: Blood, urine, and sweat study. *ISRN toxicology* 2013:483832.
- George ME, Andersen ME. 1986. Toxic effects of nonadecafluoro-n-decanoic acid in rats. *Toxicol Appl Pharmacol* 85:169-180.
- Gewurtz SB, Bhavsar SP, Crozier PW, et al. 2009. Perfluoroalkyl contaminants in window film: Indoor/outdoor, urban/rural, and winter/summer contamination and assessment of carpet as a possible source. *Environ Sci Technol* 43(19):7317-7323.
- Gewurtz SB, Bhavsar SP, Petro S, et al. 2014. High levels of perfluoroalkyl acids in sport fish species downstream of a firefighting training facility at Hamilton International Airport, Ontario, Canada. *Environ Int* 67:1-11. 10.1016/j.envint.2014.02.005.
- Giesy JP, Kannan K. 2001. Global distribution of perfluorooctane sulfonate in wildlife. *Environ Sci Technol* 35(7):1339-1342.
- Gilliland FD, Mandel JS. 1993. Mortality among employees of a perfluorooctanoic acid production plant. *J Occup Med* 35(9):950-954.
- Gilliland FD, Mandel JS. 1996. Serum perfluorooctanoic acid and hepatic enzymes, lipoproteins, and cholesterol: A study of occupationally exposed men. *Am J Ind Med* 29(5):560-568.
- Gleason JA, Post GB, Fagliano JA. 2015. Associations of perfluorinated chemical serum concentrations and biomarkers of liver function and uric acid in the US population (NHANES), 2007-2010. *Environ Res* 136:8-14. 10.1016/j.envres.2014.10.004.
- Glynn A, Berger U, Bignert A, et al. 2012. Perfluorinated alkyl acids in blood serum from primiparous women in Sweden: Serial sampling during pregnancy and nursing, and temporal trends 1996-2010. *Environ Sci Technol* 46:9071-9079.
- Goecke CM, Jarnot BM, Reo NV. 1992. A comparative toxicological investigation of perfluorocarboxylic acids in rats by fluorine-19 NMR spectroscopy. *Chem Res Toxicol* 5(4):512-519.

8. REFERENCES

- Goecke-Flora CM, Reo NV. 1996. Influence of carbon chain length on the hepatic effects of perfluorinated fatty acids. A ¹⁹F- and ³¹P-NMR investigation. *Chem Res Toxicol* 9(4):689-695.
- +Gortner EG, Lamprecht EG, Case MT. 1982. Oral teratology study of T-3141CoC in rabbits. St. Paul, MN: Riker Laboratories, Inc.
- Gotoh Y, Kato Y, Stieger B, et al. 2002. Gender difference in the Oatp1-mediated tubular reabsorption of estradiol 17 β -D-glucuronide in rats. *Am J Physiol Endocrinol Metab* 282:E1245-E1254.
- Goudarzi H, Nakajima S, Ikeno T, et al. 2016. Prenatal exposure to perfluorinated chemicals and neurodevelopment in early infancy: The Hokkaido Study. *Sci Total Environ* 541:1002-1010. 10.1016/j.scitotenv.2015.10.017.
- Govarts E, Remy S, Bruckers L, et al. 2016. Combined effects of prenatal exposures to environmental chemicals on birth weight. *Int J Environ Res Public Health* 13(5) 10.3390/ijerph13050495.
- Grandjean P, Budtz-Jorgensen E. 2013. Immunotoxicity of perfluorinated alkylates: Calculation of benchmark doses based on serum concentrations in children. *Environ Health* 12(1):35.
- Grandjean P, Andersen EW, Budtz-Jorgensen E, et al. 2012. Serum vaccine antibody concentrations in children exposed to perfluorinated compounds. *J Am Med Assoc* 307(4):391-397.
- Grandjean P, Heilmann C, Weihe P, et al. 2017. Serum vaccine antibody concentrations in adolescents exposed to perfluorinated compounds. *Environ Health Perspect*. 125(7):077018. 10.1289/EHP275.
- Granum B, Haug LS, Namork E, et al. 2013. Pre-natal exposure to perfluoroalkyl substances may be associated with altered vaccine antibody levels and immune-related health outcomes in early childhood. *J Immunotoxicol* 10(4):373-379.
- +Grasty RC, Bjork JA, Wallace KB, et al. 2005. Effects of prenatal perfluorooctane sulfonate (PFOS) exposure on lung maturation in the perinatal rat. *Birth Defects Res B Dev Reprod Toxicol* 74:405-416.
- +Grasty RC, Wolf DC, Grey BE, et al. 2003. Prenatal window of susceptibility to perfluorooctane sulfonate-induced neonatal mortality in the Sprague-Dawley rat (corrigendum in *Birth Defects Res B* 77(1):86). *Birth Defects Res B* 68(6):465-471.
- Grice MM, Alexander BH, Hoffbeck R, et al. 2007. Self-reported medical conditions in perfluorooctanesulfonyl fluoride manufacturing workers. *J Occup Environ Med* 49(7):722-729.
- +Griffith FD, Long JE. 1980. Animal toxicity studies with ammonium perfluorooctanoate. *Am Ind Hyg Assoc J* 41(8):576-583.
- Gump BB, Wu Q, Dumas AK, et al. 2011. Perfluorochemical (PFC) exposure in children: Associations with impaired response inhibition. *Environ Sci Technol* 45(19):8151-8159.
- Guo R, Sim WJ, Lee ES, et al. 2010. Evaluation of the fate of perfluoroalkyl compounds in wastewater treatment plants. *Water Res* 44(11):3476-3486. 10.1016/j.watres.2010.03.028.
- +Guruge KS, Hikono H, Shimada N, et al. 2009. Effect of perfluorooctane sulfonate (PFOS) on influenza A virus-induced mortality in female B6C3F1 mice. *J Toxicol Sci* 34(6):687-691.
- Guruge KS, Yeung LW, Yamanaka N, et al. 2006. Gene expression profiles in rat liver treated with perfluorooctanoic acid (PFOA). *Toxicol Sci* 89(1):93-107.
- Gützkow KB, Haug LS, Thomsen C, et al. 2012. Placental transfer of perfluorinated compounds is selective. A Norwegian mother and child sub-cohort study. *Int J Hyg Environ Health* 215(2):216-219.
- +Hadrup N, Pedersen M, Skov K, et al. 2016. Perfluorononanoic acid in combination with 14 chemicals exerts low-dose mixture effects in rats. *Arch Toxicol* 90(3):661-675. 10.1007/s00204-015-1452-6.
- HAES. 2017. GEF-Reduction and phase-out of PFOS in priority sectors in China. Environmental & Social Management Framework. Hubei Academy of Environmental Sciences, Foreign Economic Cooperation Office, Ministry of Environmental Protection (FECO). <http://documents.worldbank.org/curated/en/2752514607008/Environmental-and-social-management-framework>. February 28, 2017.
- Hall AP, Elcombe CR, Foster JR, et al. 2012. Liver hypertrophy: A review of adaptive (adverse and non-adverse) changes- conclusions from the 3rd International ESTP Expert Workshop. *Toxicol Pathol* 40:971-994.

8. REFERENCES

- Halldorsson TI, Rytter D, Haug LS, et al. 2012. Prenatal exposure to perfluorooctanoate and risk of overweight at 20 years of age: A prospective cohort study. *Environ Health Perspect* 120(5):668-673.
- +Hallgren S, Fredriksson A, Viberg H. 2015. More signs of neurotoxicity of surfactants and flame retardants - neonatal PFOS and PBDE 99 cause transcriptional alterations in cholinergic genes in the mouse CNS. *Environ Toxicol Pharmacol* 40(2):409-416. 10.1016/j.etap.2015.06.014.
- Hamm MP, Cherry NM, Chan E, et al. 2010. Maternal exposure to perfluorinated acids and fetal growth. *J Expo Sci Environ Epidemiol* 20(7):589-597.
- Hamm MP, Martin JW, Chan E, et al. 2009. Maternal exposure to perfluorinated acids and fetal growth restriction. *Am J Epidemiol* 169(Suppl. 11):S43.
- Han X, Hinderliter PM, Snow TA, et al. 2004. Binding of perfluorooctanoic acid to rat liver-form and kidney-form α 2u-globulins. *Drug Chem Toxicol* 27(4):341-360.
- Han X, Kemper RA, Jepson GW. 2005. Subcellular distribution and protein binding of perfluorooctanoic acid in rat liver and kidney. *Drug Chem Toxicol* 28(2):197-209.
- Han X, Snow TA, Kemper RA, et al. 2003. Binding of perfluorooctanoic acid to rat and human plasma proteins. *Chem Res Toxicol* 16:775-781.
- Hanhijarvi H, Ophaug RH, Singer L. 1982. The sex-related difference in perfluorooctanoate excretion in the rat. *Proc Soc Exp Biol Med* 171:50-55.
- Hanhijarvi H, Ylinen M, Kojo A, et al. 1987. Elimination and toxicity of perfluorooctanoic acid during subchronic administration in the Wistar rat. *Pharmacol Toxicol* 61(1):66-68.
- Hansen KJ, Johnson HO, Eldridge JS, et al. 2002. Quantitative characterization of trace levels of PFOS and PFOA in the Tennessee River. *Environ Sci Technol* 36:1681-1685.
- Hanssen L, Dudarev AA, Huber S, et al. 2013. Partition of perfluoroalkyl substances (PFASs) in whole blood and plasma, assessed in maternal and umbilical cord samples from inhabitants of arctic Russia and Uzbekistan. *Sci Total Environ* 447:430-437.
- Hanssen L, Rollin H, Odland JO, et al. 2010. Perfluorinated compounds in maternal serum and cord blood from selected areas of South Africa: Results of a pilot study. *J Environ Monit* 12(6):1355-1361.
- Harada K, Inoue K, Morikawa A, et al. 2005a. Renal clearance of perfluorooctane sulfonate and perfluorooctanoate in humans and their species-specific excretion. *Environ Res* 99:253-261.
- Harada K, Nakanishi S, Saito N, et al. 2005b. Airborne perfluorooctanoate may be a substantial source contamination in Kyoto area, Japan. *Bull Environ Contam Toxicol* 74:64-69.
- Harada K, Nakanishi S, Sasaki K, et al. 2006. Particle size distribution and respiratory deposition estimates of airborne perfluorooctanoate and perfluorooctanesulfonate in Kyoto area, Japan. *Bull Environ Contam Toxicol* 76(2):306-310.
- Harada KH, Koizumi A. 2009. Environmental and biological monitoring of persistent fluorinated compounds in Japan and their toxicities. *Environ Health Prev Med* 14(1):7-19.
- Harada KH, Hashida S, Kaneko T, et al. 2007. Biliary excretion and cerebrospinal fluid partition of perfluorooctanoate and perfluorooctane sulfonate in humans. *Environ Toxicol Pharmacol* 24(2):134-139.
- Hardell E, Karrman A, van Bavel B, et al. 2014. Case-control study on perfluorinated alkyl acids (PFAAs) and the risk of prostate cancer. *Environ Int* 63:35-39.
- Hardisty JF, Willson GA, Brown WR, et al. 2010. Pathology Working Group review and evaluation of proliferative lesions of mammary gland tissues in female rats fed ammonium perfluorooctanoate (APFO) in the diet for 2 years. *Drug Chem Toxicol* 33(2):131-137.
- Harris LA, Barton HA. 2008. Comparing single and repeated dosimetry data for perfluorooctane sulfonate in rats. *Toxicol Lett* 181(3):148-156.
- +Harris MW, Birnbaum LS. 1989. Developmental toxicity of perfluorodecanoic acid in C57BL/6N mice. *Fundam Appl Toxicol* 12:442-448.
- +Harris MW, Uraih LC, Birnbaum LS. 1989. Acute toxicity of perfluorodecanoic acid in C57BL/6 mice differs from 2,3,7,8-tetrachlorodibenzo-p-dioxin. *Fundam Appl Toxicol* 13:723-726.

8. REFERENCES

- +Haugom B, Spydevold O. 1992. The mechanism underlying the hypolipemic effect of perfluorooctanoic acid (PFOA), perfluorooctane sulphonic acid (PFOSA) and clofibrilic acid. *Biochim Biophys Acta* 1128(1):65-72.
- Heilmann C, Budtz-Jorgensen E, Nielsen F, et al. 2010. Serum concentrations of antibodies against vaccine toxoids in children exposed perinatally to immunotoxicants. *Environ Health Perspect* 118(10):1434-1438. 10.1289/ehp.1001975.
- Hekster FM, Laane RW, de Voogt P. 2003. Environmental and toxicity effects of perfluoroalkylated substances. *Rev Environ Contam Toxicol* 179:99-121.
- Henderson WM, Smith MA. 2007. Perfluorooctanoic acid and perfluorononanoic acid in fetal and neonatal mice following *in utero* exposure to 8-2 fluorotelomer alcohol. *Toxicol Sci* 95(2):452-461.
- Hinderliter PM, DeLorme MP, Kennedy GL. 2006a. Perfluorooctanoic acid: Relationship between repeated inhalation exposures and plasma PFOA concentration in the rat. *Toxicology* 222:80-85.
- Hinderliter PM, Han X, Kennedy GL, et al. 2006b. Age effect on perfluorooctanoate (PFOA) plasma concentration in post-weaning rats following oral gavage with ammonium perfluorooctanoate (APFO). *Toxicology* 225:195-203.
- Hinderliter PM, Mylchreest E, Gannon SA, et al. 2005. Perfluorooctanoate: Placental and lactational transport pharmacokinetics in rats. *Toxicology* 211:139-148.
- +Hines EP, White SS, Stanko JP, et al. 2009. Phenotypic dichotomy following developmental exposure to perfluorooctanoic acid (PFOA) in female CD-1 mice: Low doses induce elevated serum leptin and insulin, and overweight in mid-life. *Mol Cell Endocrinol* 304(1-2):97-105.
- +Hoberman AM, York RG. 2003. Oral (gavage) combined repeated dose toxicity study of T-7706 with the reproduction/developmental toxicity screening test. Argus Research.
- Hoffman K, Webster TF, Bartell SM, et al. 2011. Private drinking water wells as a source of exposure to perfluorooctanoic acid (PFOA) in communities surrounding a fluoropolymer production facility. *Environ Health Perspect* 119(1):92-97.
- Hoffman K, Webster TF, Weisskopf MG, et al. 2010. Exposure to polyfluoroalkyl chemicals and attention deficit/hyperactivity disorder in U.S. children 12-15 years of age. *Environ Health Perspect* 118(12):1762-1767.
- Hölzer J, Midasch O, Rauchfuss K, et al. 2008. Biomonitoring of perfluorinated compounds in children and adults exposed to perfluorooctanoate-contaminated drinking water. *Environ Health Perspect* 116(5):651-657.
- Houde M, Bujas TD, Small J, et al. 2006a. Biomagnification of perfluoroalkyl compounds in the bottlenose dolphin (*Tursiops truncatus*) food web. *Environ Sci Technol* 40:4138-4144.
- Houde M, Martin JW, Letcher RJ, et al. 2006b. Biological monitoring of polyfluoroalkyl substances: A Review. *Environ Sci Technol* 40(11):3463-3473.
- Houde M, Wells RS, Fair PA, et al. 2005. Polyfluoroalkyl compounds in free-ranging bottlenose dolphins (*Tursiops truncatus*) from the Gulf of Mexico and the Atlantic Ocean. *Environ Sci Technol* 39:6591-6598.
- Høyer BB, Ramlau-Hansen CH, Obel C, et al. 2015a. Pregnancy serum concentrations of perfluorinated alkyl substances and offspring behaviour and motor development at age 5-9 years--a prospective study. *Environ Health* 14:2. 10.1186/1476-069x-14-2.
- Høyer BB, Ramlau-Hansen CH, Vrijheid M, et al. 2015b. Anthropometry in 5- to 9-Year-Old Greenlandic and Ukrainian Children in Relation to Prenatal Exposure to Perfluorinated Alkyl Substances. *Environ Health Perspect* 123(8):841-846. 10.1289/ehp.1408881.
- Hsu V, de LTVM, Zhao P, et al. 2014. Towards quantitation of the effects of renal impairment and probenecid inhibition on kidney uptake and efflux transporters, using physiologically based pharmacokinetic modelling and simulations. *Clin Pharmacokinet* 53(3):283-293. 10.1007/s40262-013-0117-y.
- +Hu Q, Strynar MJ, DeWitt JC. 2010. Are developmentally exposed C57BL/6 mice insensitive to suppression of TDAR by PFOA? *J Immunotoxicol* 7(4):344-349.

8. REFERENCES

- Hu W, Jones PD, Upham BL, et al. 2002. Inhibition of gap junctional intercellular communication by perfluorinated compounds in rat liver and dolphin kidney epithelial cell lines *in vitro* and Sprague-Dawley rats *in vivo*. *Toxicol Sci* 68(2):429-426.
- Hu XC, Andrews DQ, Lindstrom M, et al. 2016. Detection of poly-and perfluoroalkyl substances (PFASs) in U.S. drinking water linked to industrial sites, military fire training areas and wastewater treatment plants. *Environ Sci Technol Lett* 3:344-350. DOI: 10.1021/acs.estlett.6b00260.
- Humblet O, Dias-Ramirez LG, Balmes JR, et al. 2014. Perfluoroalkyl chemicals and asthma among children 12-19 years of age: NHANES (1999-2008). *Environ Health Perspect* 122(10):1129-1133.
- Hundley SG, Sarrif AM, Kennedy GL. 2006. Absorption, distribution, and excretion of ammonium perfluorooctanoate (APFO) after oral administration to various species. *Drug Chem Toxicol* 29(2):137-145.
- Hurley MD, Andersen MPS, Wallington TJ, et al. 2004. Atmospheric chemistry of perfluorinated carboxylic acids: Reaction with OH radicals and atmospheric lifetimes. *J Phys Chem* 108:615-620.
- IARC. 2017. Agents classified by the IARC Monographs, Volumes 1–117. Lyon, France: International Agency for Research on Cancer.
http://monographs.iarc.fr/ENG/Classification/List_of_Classifications.pdf. February 28, 2017.
- ICRP. 1981. Report of the task group on reference man. ICRP Publication 28. International Commission on Radiological Protection. Oxford: Pergamon Press, 32-40.
- +Ikeda T, Aiba K, Fukuda K, et al. 1985. The induction of peroxisome proliferation in rat liver by perfluorinated fatty acids, metabolically inert derivatives of fatty acids. *J Biochem (Tokyo)*98:475-482.
- Innes KE, Ducatman AM, Luster MI, et al. 2011. Association of osteoarthritis with serum levels of the environmental contaminants perfluorooctanoate and perfluorooctane sulfonate in a large Appalachian population. *Am J Epidemiol* 174(4):440-450.
- Innes KE, Wimsatt JH, Frisbee S, et al. 2014. Inverse association of colorectal cancer prevalence to serum levels of perfluorooctane sulfonate (PFOS) and perfluorooctanoate (PFOA) in a large Appalachian population. *BMC Cancer*[electronic resource].
<http://www.bilomedcentral.com/1471/14/45>. December 10, 2011.
- Inoue K, Okada F, Ito R, et al. 2004. Perfluorooctane sulfonate (PFOS) and related perfluorinated compounds in human maternal and cord blood samples: Assessment of PFOS exposure in a susceptible population during pregnancy. *Environ Health Perspect* 112:1204-1207.
- IRIS. 2017. IRIS quick list. Integrated Risk Information System. Washington, DC: U.S. Environmental Protection Agency.
https://cfpub.epa.gov/ncea/iris_drafts/simple_list.cfm?list_type=alpha. February 28, 2017.
- Issemann I, Green S. 1990. Activation of a member of a steroid hormone receptor superfamily by peroxisome proliferators. *Nature* 347:645-650.
- Itoh S, Araki A, Mitsui T, et al. 2016. Association of perfluoroalkyl substances exposure *in utero* with reproductive hormone levels in cord blood in the Hokkaido Study on Environment and Children's Health. *Environ Int* 94:51-59. 10.1016/j.envint.2016.05.011.
- +Iwai H, Hoberman AM. 2014. Oral (gavage) combined developmental and perinatal/postnatal reproduction toxicity study of ammonium salt of perfluorinated hexanoic acid in mice. *Int J Toxicol* 33(3):219-237.
- +Iwai H, Yamashita K. 2006. A fourteen-day repeated dose oral toxicity study of APFO in rats. *Drug Chem Toxicol* 29:323-332.
- Jacquet N, Maire MA, Landkocz Y, et al. 2012. Carcinogenic potency of perfluorooctane sulfonate (PFOS) on Syrian hamster embryo (SHE) cells. *Arch Toxicol* 86(2):305-314.
- Jahnke A, Berger U, Ebinghaus R, et al. 2007a. Latitudinal gradient of airborne polyfluorinated alkyl substances in the marine atmosphere between Germany and South Africa (53° N-33° S). *Environ Sci Technol* 41(9):3055-3061.

8. REFERENCES

- Jahnke A, Huber S, Temme C, et al. 2007b. Development and application of a simplified sampling method for volatile polyfluorinated alkyl substances in indoor and environmental air. *J Chromatogr A* 1164:1-9.
- Jain RB. 2013. Association between thyroid profile and perfluoroalkyl acids: Data from NHNAES 2007-2008. *Environ Res* 126:51-59. 10.1016/j.envres.2013.08.006.
- Jain RB. 2015. Estimation of the total concentration of perfluoroalkyl acids (PFAA) in human serum: Data from NHANES 2005-2012. *Chemosphere* 134:387-394. 10.1016/j.chemosphere.2015.04.104.
- Jandacek RJ, Rider T, Keller ER, et al. 2010. The effect of olestra on the absorption, excretion and storage of 2,2',5,5' tetrachlorobiphenyl; 3,3',4,4' tetrachlorobiphenyl; and perfluorooctanoic acid. *Environ Int* 36(8):880-883.
- Jensen MS, Norgaard-Pedersen B, Toft G, et al. 2012. Phthalates and perfluorooctanesulfonic acid in human amniotic fluid: Temporal trends and timing of amniocentesis in pregnancy. *Environ Health Perspect* 120(6):897-903.
- Jensen TK, Andersen LB, Kyhl HB, et al. 2015. Association between perfluorinated compound exposure and miscarriage in Danish pregnant women. *PLoS ONE* 10(4):e0123496. 10.1371/journal.pone.0123496.
- Ji K, Kim S, Kho Y, et al. 2012. Serum concentrations of major perfluorinated compounds among the general population in Korea: Dietary sources and potential impact on thyroid hormones. *Environ Int* 45:78-85.
- Jiang Q, Lust RM, Dewitt JC. 2013. Perfluorooctanoic acid induced-developmental cardiotoxicity: Are peroxisome proliferator activated receptor α (PPAR α) and bone morphogenetic protein 2 (BMP2) pathways involved? *J Toxicol Environ Health A* 76(11):635-650. 10.1080/15287394.2013.789415.
- Jiang Q, Lust RM, Strynar MJ, et al. 2012. Perfluorooctanoic acid induces developmental cardiotoxicity in chicken embryos and hatchlings. *Toxicology* 293(1-3):97-106. 10.1016/j.tox.2012.01.005.
- Jiang Q, Ma W, Wu J, et al. 2016. Perfluorooctanoic acid-induced toxicity in primary cultures of chicken embryo cardiomyocytes. *Environ Toxicol* 31(11):1580-1590. 10.1002/tox.22162. <http://dx.doi.org/10.1002/tox.22162>.
- Jin C, Sun Y, Islam A, et al. 2011. Perfluoroalkyl acids including perfluorooctane sulfonate and perfluorohexane sulfonate in firefighters. *J Occup Environ Med* 53(3):324-328. 10.1097/JOM.0b013e31820d1314.
- Jin YH, Liu W, Sato I, et al. 2009. PFOS and PFOA in environmental and tap water in China. *Chemosphere* 77(5):605-611.
- Joensen UN, Bossi R, Leffers H, et al. 2009. Do perfluoroalkyl compounds impair human semen quality? *Environ Health Perspect* 117(6):923-927.
- Joensen UN, Veyrand B, Antignac JP, et al. 2013. PFOS (perfluorooctanesulfonate) in serum is negatively associated with testosterone levels, but not with semen quality, in healthy men. *Hum Reprod* 28(3):599-608.
- Jogsten IE, Perello G, Llebaria X, et al. 2009. Exposure to perfluorinated compounds in Catalonia, Spain, through consumption of various raw and cooked foodstuffs, including packaged food. *Food Chem Toxicol* 47:1577-1583.
- Johansson JH, Berger U, Vestergren R, et al. 2014. Temporal trends (1999-2010) of perfluoroalkyl acids in commonly consumed food items. *Environ Pollut* 188:102-108. 10.1016/j.envpol.2014.01.026.
- Johansson N, Eriksson P, Viberg H. 2009. Neonatal exposure to PFOS and PFOA in mice results in changes in proteins which are important for neuronal growth and synaptogenesis in the developing brain. *Toxicol Sci* 108(2):412-418.
- +Johansson N, Fredriksson A, Eriksson P. 2008. Neonatal exposure to perfluorooctane sulfonate (PFOS) and perfluorooctanoic acid (PFOA) causes neurobehavioural defects in adult mice. *Neurotoxicology* 29:160-169.
- Johnson JD. 1995a. Final report. Analytical study, single-dose dermal absorption/toxicity study of T6049 in rabbits. *In vivo* reference number: HWI#6329-130. 3M. SCD Division.

8. REFERENCES

- Johnson JD. 1995b. Final report. Analytical study, single-dose dermal absorption/toxicity study of T6053 in rabbits (lithium perfluorooctane sulfonate). *In vivo* study reference number: HWI#6329-137. 3M. SCD Division.
- Johnson JD, Ober RE. 1979. Absorption of FC-95-¹⁴C in rats after a single oral dose. 3M. Submitted to the U.S. Environmental Protection Agency's Administrative Record. AR226-0007.
- Johnson JD, Ober RE. 1980. Extent and route of excretion and tissue distribution of total carbon-14 in rats after a single intravenous dose of FC-95-¹⁴C. 3M. Submitted to the U.S. Environmental Protection Agency's Administrative Record. AR226-0006.
- Johnson JD, Ober RE. 1999a. Absorption of FC-143-¹⁴C in rats after a single oral dose. In: Exploratory 28-day oral toxicity study with telomer alcohol, telomer acrylate, PFHS, and PFOS (POS control) by daily gavage in the rat, w/CVR LTR DTD, 051500 (Sanitized). 3M. Submitted to the U.S. Environmental Protection Agency under TSCA Section FYI. OTS05001378S.
- Johnson JD, Ober RE. 1999b. Extent and route of excretion and tissue distribution of total carbon-14 in male and female rats after a single IV dose of FC-143-¹⁴C. In: Exploratory 28-day oral toxicity study with telomer alcohol, telomer acrylate, PFHS, and PFOS (POS control) by daily gavage in the rat, w/CVR letter dated, 051500 (Sanitized). 3M. Submitted to the U.S. Environmental Protection Agency under TSCA Section FYI. OTS05001378S.
- Johnson JD, Gibson SJ, Ober RE. 1984. Cholestyramine-enhanced fecal elimination of carbon-14 in rats after administration of ammonium [¹⁴C]perfluorooctanoate or potassium [¹⁴C]perfluorooctane-sulfonate. *Fundam Appl Toxicol* 4:972-976.
- Jones CM. 2016. 2010/1015 PFOA Stewardship Program. Docket ID number EPA-HQ-OPPT-2006-0621. <https://www.regulations.gov/document?D=EPA-HQ-OPPT-2006-0621-0115>. February 28, 2017.
- Jørgensen KT, Specht IO, Lenters V, et al. 2014a. Perfluoroalkyl substances and time to pregnancy in couples from Greenland, Poland and Ukraine. *Environ Health* 13:116. 10.1186/1476-069x-13-116.
- Jørgensen KT, Specht IO, Lenters V, et al. 2014b. Supplemental files to "Perfluoroalkyl substances and time to pregnancy in couples from Greenland, Poland and Ukraine" [*Environ Health* 13:116. 10.1186/1476-069x-13-116]. *Environ Health* 10.1186/1476-069x-13-116.
- Jurado-Sanchez B, Ballesteros E, Gallego M. 2014. Analytical method for biomonitoring of perfluoroalkyl acids in human urine. *Talanta* 128:141-146. 10.1016/j.talanta.2014.04.071.
- Kaiser MA, Larsen BS, Kao CPC, et al. 2005. Vapor pressures of perfluorooctanoic, -nonanoic, -decanoic, -undecanoic, and -dodecanoic acids. *J Chem & Eng Data* 50:1841-1843.
- Kang H, Choi K, Lee HS, et al. 2016. Elevated levels of short carbon-chain PFCAs in breast milk among Korean women: Current status and potential challenges. *Environ Res* 148:351-359.
- Kannan K, Choi JW, Iseki Net al. 2002a. Concentrations of perfluorinated acids in livers of birds from Japan and Korea. *Chemosphere* 49(3):225-231.
- Kannan K, Corsolini S, Falandysz J, et al. 2002b. Perfluorooctanesulfonate and related fluorinated hydrocarbons in marine mammals, fishes, and birds from coasts of the Baltic and the Mediterranean Seas. *Environ Sci Technol* 36(15):3210-3216.
- Kannan K, Franson JC, Bowerman WW, et al. 2001a. Perfluorooctane sulfonate in fish-eating water birds including bald eagles and albatrosses. *Environ Sci Technol* 35(15):3065-3070.
- Kannan K, Hansen KJ, Wade TL, et al. 2002c. Perfluorooctane sulfonate in oysters, *Crassostrea virginica*, from the Gulf of Mexico and the Chesapeake Bay, USA. *Arch Environ Contam Toxicol* 42(3):313-318.
- Kannan K, Koistinen J, Beckmen K, et al. 2001b. Accumulation of perfluorooctane sulfonate in marine mammals. *Environ Sci Technol* 35:1593-1598.
- Kannan K, Newsted J, Halbrook RS, et al. 2002d. Perfluorooctanesulfonate and related fluorinated hydrocarbons in mink and river otters from the United States. *Environ Sci Technol* 36:2566-2571.
- Kannan K, Perrotta E, Thomas NJ. 2006. Association between perfluorinated compounds and pathological conditions in southern sea otters. *Environ Sci Technol* 40:4943-4948.

8. REFERENCES

- Kannan K, Tao L, Sinclair E, et al. 2005. Perfluorinated compounds in aquatic organisms at various trophic levels in a Great Lakes food chain. *Arch Environ Contam Toxicol* 48:559-566.
- Karnes C, Winqvist A, Steenland K. 2014. Incidence of type II diabetes in a cohort with substantial exposure to perfluorooctanoic acid. *Environ Res* 128:78-83. 10.1016/j.envres.2013.11.003.
- Kärman A, Ericson I, van Bavel B, et al. 2007. Exposure of perfluorinated chemicals through lactation: Levels of matched human milk and serum and a temporal trend, 1996-2004, in Sweden. *Environ Health Perspect* 115:226-230.
- Kärman A, van Bavel B, Jarnberg U, et al. 2005. Development of a solid-phase extraction-HPLC/single quadrupole MS method for quantification of perfluorochemicals in whole blood. *Anal Chem* 77:864-870.
- Katakura M, Kudo N, Tsuda T, et al. 2007. Rat organic anion transporter 3 and organic anion transporting polypeptide 1 mediate perfluorooctanoic acid transport. *J Health Sci* 53:77-83.
- Kataria A, Trachtman H, Malaga-Diequez L, et al. 2015. Association between perfluoroalkyl acids and kidney function in a cross-sectional study of adolescents. *Environ Health* 14:89. 10.1186/s12940-015-0077-9.
- Kato K, Calafat AM, Needham LL. 2009a. Polyfluoroalkyl chemicals in house dust. *Environ Res* 109(12):518-523.
- Kato K, Calafat AM, Wong LY, et al. 2009b. Polyfluoroalkyl compounds in pooled sera from children participating in the National Health and Nutrition Examination Survey 2001-2002. *Environ Sci Technol* 43(7):2641-2647.
- Kato K, Wong LY, Chen A, et al. 2014. Changes in serum concentrations of maternal poly- and perfluoroalkyl substances over the course of pregnancy and predictors of exposure in a multiethnic cohort of Cincinnati, Ohio pregnant women during 2003-2006. *Environ Sci Technol* 48(16):9600-9608.
- Kauck EA, Diesslin AR. 1951. Some properties of perfluorocarboxylic acids. *Ind Eng Chem* 43(10):2332-2334.
- Kawabata K, Matsuzaki H, Nukui S, et al. 2017. Perfluorododecanoic acid induces cognitive deficit in adult rats. *Toxicol Sci* 157(2):421-428. 10.1093/toxsci/kfx058.
- Kawamoto K, Oashi T, Oami K, et al. 2010. Perfluorooctanoic acid (PFOA) but not perfluorooctane sulfonate (PFOS) showed DNA damage in comet assay on *Paramecium caudatum*. *J Toxicol Sci* 35(6):835-841.
- +Kawamoto K, Sato I, Tsuda S, et al. 2011. Ultrasonic-induced tonic convulsion in rats after subchronic exposure to perfluorooctane sulfonate (PFOS). *J Toxicol Sci* 36(1):55-62.
- +Kawashima Y, Kobayashi H, Miura H, et al. 1995. Characterization of hepatic responses of rat to administration of perfluorooctanoic and perfluorododecanoic acids at low levels. *Toxicology* 99(3):169-178.
- +Keil DE, Mehlmann T, Butterworth L, et al. 2008. Gestational exposure to perfluorooctane sulfonate (PFOS) suppresses immune function in B6C3F1 mice. *Toxicol Sci* 103(1):77-85.
- Keller JM, Kannan K, Taniyasu S, et al. 2005. Perfluorinated compounds in the plasma of loggerhead and Kemp's ridley sea turtles from the southeastern coast of the United States. *Environ Sci Technol* 39:9101-9108.
- Kelly J, Solem L. 2009. Identification of a major source of perfluorooctane sulfonate (PFOS) at a wastewater treatment plant in Brainerd, Minnesota. *Reprod Toxicol* 27:417-428.
- Kelly BC, Ikonomou MG, Blair JD, et al. 2007. Food web-specific biomagnification of persistent organic pollutants. *Science* 317:236-238.
- Kemper RA. 2003. Perfluorooctanoic acid: Toxicokinetics in the rat. Association of Plastics Manufacturers of Europe. Submitted to the U.S. Environmental Protection Agency's Administrative Record. AR226-1499.
- Kemper RA, Nabb DL. 2005. *In vitro* studies in microsomes from rat and human liver, kidney, and intestine suggest that perfluorooctanoic acid is not a substrate for microsomal UDP-glucuronosyltransferases. *Drug Chem Toxicol* 28(3):281-287.

8. REFERENCES

- +Kennedy GL. 1985. Dermal toxicity of ammonium perfluorooctanoate. *Toxicol Appl Pharmacol* 81(2):348-355.
- +Kennedy GL. 1987. Increase in mouse liver weight following feeding of ammonium perfluorooctanoate and related fluorochemicals. *Toxicol Lett* 39(2-3):295-300.
- Kennedy GL, Butenhoff JL, Olsen GW, et al. 2004. The toxicology of perfluorooctanoate. *Crit Rev Toxicol* 34(4):351-384.
- +Kennedy GL, Hall GT, Brittelli MR, et al. 1986. Inhalation toxicity of ammonium perfluorooctanoate. *Food Chem Toxicol* 24(12):1325-1329.
- Kerstner-Wood C, Coward L, Gorman G. 2003. Protein binding of perfluorohexane sulfonate, perfluorooctane sulfonate and perfluorooctanoate to plasma (human, rat, and monkey), and various human-derived plasma protein fractions. Southern Research Institute. Submitted to the U.S. Environmental Protection Agency's Administrative Record. AR226-1354.
- Khalil N, Chen A, Lee M, et al. 2016. Association of perfluoroalkyl substances, bone mineral density, and osteoporosis in the U.S. Population in NHANES 2009-2010. *Environ Health Perspect* 124(1):81-87. 10.1289/ehp.1307909.
- Kielsen K, Shamin Z, Ryder LP, et al. 2016. Antibody response to booster vaccination with tetanus and diphtheria in adults exposed to perfluorinated alkylates. *J Immunotoxicol* 13(2):270-273.
- Kim S, Kannan K. 2007. Perfluorinated acids in air, rain, snow, surface runoff, and lakes: Relative importance of pathways to contamination of urban lakes. *Environ Sci Technol* 41:8328-8334.
- Kim DH, Kim UJ, Kim HY, et al. 2016a. Perfluoroalkyl substances in serum from South Korean infants with congenital hypothyroidism and healthy infants - Its relationship with thyroid hormones. *Environ Res* 147:399-404. 10.1016/j.envres.2016.02.037.
- Kim SJ, Heo SH, Lee DS, et al. 2016b. Gender differences in pharmacokinetics and tissue distribution of 3 perfluoroalkyl and polyfluoroalkyl substances in rats. *Food Chem Toxicol* 97:243-255.
- Kim SK, Lee KT, Kang CS, et al. 2011. Distribution of perfluorochemicals between sera and milk from the same mothers and implications for prenatal and postnatal exposures. *Environ Pollut* 159(1):169-174.
- +Kinney LA, Chromey NC, Kennedy Jr GL. 1989. Acute inhalation toxicity of ammonium perfluorononanoate. *Food Chem Toxicol* 21(1):46-68.
- Kishi R, Nakajima T, Goudarzi H, et al. 2015. The association of prenatal exposure to perfluorinated chemicals with maternal essential and long-chain polyunsaturated fatty acids during pregnancy and the birth weight of their offspring: The Hokkaido Study. *Environ Health Perspect* 123(10):1038-1045. 10.1289/ehp.1408834.
- Kissa E. 2001. Fluorinated surfactants and repellents. 2nd ed. Revised and expanded. New York, NY: Marcel Dekker, Inc., 1-101, 198-269, 349-379, 451-487.
- Kjeldsen LS, Bonfeld-Jørgensen EC. 2013. Perfluorinated compounds affect the function of sex hormone receptors. *Environ Sci Pollut Res Int* 20(11):8031-8044.
- Klaunig JE, Babich MA, Baetcke KP, et al. 2003. PPAR α agonist-induced rodent tumors: Modes of action and human relevance. *Crit Rev Toxicol* 33(6):655-780.
- Klaunig JE, Hocevar BA, Kamendulis LM. 2012. Mode of action analysis of perfluorooctanoic acid (PFOA) tumorigenicity and human relevance. *Reprod Toxicol* 33(4):410-418.
- +Klaunig JE, Shinohara M, Iwai H, et al. 2015. Evaluation of the chronic toxicity and carcinogenicity of perfluorohexanoic acid (PFHxA) in Sprague-Dawley rats. *Toxicol Pathol* 43(2):209-220. 10.1177/0192623314530532.
- Knox SS, Jackson T, Frisbee SJ, et al. 2011a. Perfluorocarbon exposure, gender and thyroid function in the C8 Health Project. *J Toxicol Sci* 36(4):403-410.
- Knox SS, Jackson T, Javins B, et al. 2011b. Implications of early menopause in women exposed to perfluorocarbons. *J Clin Endocrinol Metab* 96(6):1747-1753. I 10.1210/jc.2010-2401.
- Kobayashi Y, Hirokawa N, Ohshiro N, et al. 2002. Differential gene expression of organic anion transporters in male and female rats. *Biochem Biophys Res Commun* 290:482-487.

8. REFERENCES

- Konwick BJ, Tomy GT, Ismail N, et al. 2008. Concentrations and patterns of perfluoroalkyl acids in Georgia, USA surface waters near and distant to a major use source. *Environ Toxicol Chem* 27(10):2011-2018.
- +Koskela A, Finnila MA, Korkalainen M, et al. 2016. Effects of developmental exposure to perfluorooctanoic acid (PFOA) on long bone morphology and bone cell differentiation. *Toxicol Appl Pharmacol* 301:14-21. 10.1016/j.taap.2016.04.002.
- Kotthoff M, Muller J, Jurling H, et al. 2015. Perfluoroalkyl and polyfluoroalkyl substances in consumer products. *Environ Sci Pollut Res Int* 22(19):14546-14559. 10.1007/s11356-015-4202-7.
- Koustas E, Lam J, Sutton P, et al. 2014. The Navigation Guide - evidence-based medicine meets environmental health: Systematic review of nonhuman evidence for PFOA effects on fetal growth. *Environ Health Perspect* 122(10):1015-1027.
- Krishnan K, Andersen ME, Clewell HJ, et al. 1994. Physiologically based pharmacokinetic modeling of chemical mixtures. In: Yang RSH, ed. *Toxicology of chemical mixtures: Case studies, mechanisms, and novel approaches*. San Diego, CA: Academic Press, 399-437.
- Kristensen SL, Ramlau-Hansen CH, Ernst E, et al. 2013. Long-term effects of prenatal exposure to perfluoroalkyl substances on female reproduction. *Hum Reprod* 28(12):3337-3348. 10.1093/humrep/det382.
- Kroschwitz JI, Howe-Grant M. 1994. Perfluorooctanoic. *Kirk-Othmer encyclopedia of chemical toxicology*. 4th ed. Vol. 11. New York, NY: John Wiley & Sons, Inc., 551.
- Krusic PJ, Roe DC. 2004. Gas-phase NMR technique for studying the thermolysis of materials: Thermal decomposition of ammonium perfluorooctanoate. *Anal Chem* 76(13):3800-3803.
- Krusic PJ, Marchione AA, Roe DC. 2005. Gas-phase NMR studies of the thermolysis of perfluorooctanoic acid. *J Fluor Chem* 126:1510-1516.
- Kubwabo C, Stewart B, Zhu J, et al. 2005. Occurrence of perfluorosulfonates and other perfluorochemicals in dust from selected homes in the city of Ottawa, Canada. *J Environ Monit* 7:1074-1078.
- Kudo N, Kawashima Y. 1997. Fish oil-feeding prevents perfluorooctanoic acid-induced fatty liver in mice. *Toxicol Appl Pharmacol* 145(2):285-293.
- Kudo N, Kawashima Y. 2003. Induction of triglyceride accumulation in the liver of rats by perfluorinated fatty acids with different carbon chain lengths: Comparison with induction of peroxisomal β -oxidation. *Biol Pharm Bull* 26(1):47-51.
- Kudo N, Bandai N, Suzuki E, et al. 2000. Induction by perfluorinated fatty acids with different carbon chain length of peroxisomal β -oxidation in the liver of rats. *Chem Biol Interact* 124:119-132.
- Kudo N, Iwase Y, Okayachi H, et al. 2005. Induction of hepatic peroxisome proliferation by 8-2 telomer alcohol feeding in mice: Formation of perfluorooctanoic acid in the liver. *Toxicol Sci* 86(2):231-238.
- Kudo N, Katakura M, Sato Y, et al. 2002. Sex hormone-regulated renal transport of perfluorooctanoic acid. *Chem Biol Interact* 139:301-316.
- Kudo N, Mizuguchi H, Yamamoto A, et al. 1999. Alterations by perfluorooctanoic acid of glycerolipid metabolism in rat liver. *Chem Biol Interact* 118:69-83.
- Kudo N, Sakai A, Mitsumoto A, et al. 2007. Tissue distribution and hepatic subcellular distribution of perfluorooctanoic acid at low dose are different from those at high dose in rats. *Biol Pharm Bull* 30(8):1535-1540.
- Kudo N, Suzuki E, Katakura M, et al. 2001. Comparison of the elimination between perfluorinated fatty acids with different carbon chain length in rats. *Chem Biol Interact* 134:203-216.
- Kudo N, Suzuki-Nakajima E, Mitsumoto A, et al. 2006. Responses of the liver to perfluorinated fatty acids with different carbon chain length in male and female mice: In relation to induction of hepatomegaly, peroxisomal β -oxidation and microsomal 1-acylglycerophosphocholine acyltransferase. *Biol Pharm Bull* 29(9):1952-1957.

8. REFERENCES

- Kuklennyik Z, Reich JA, Tully JS, et al. 2004. Automated solid-phase extraction and measurement of perfluorinated organic acids and amides in human serum and milk. *Environ Sci Technol* 38(13):3698-3704.
- Kunleda H, Shinoda K. 1976. Krafft points, critical micelle concentrations, surface tension, and solubilizing power of aqueous solutions of fluorinated surfactants. *J Phys Chem* 80:2468-2470.
- Kvist L, Giwercman YL, Jonsson BA, et al. 2012. Serum levels of perfluorinated compounds and sperm Y:X chromosome ratio in two European populations and in Inuit from Greenland. *Reprod Toxicol* 34(4):644-650.
- Landsteiner A, Huset C, Johnson J, et al. 2014. Biomonitoring for perfluorochemicals in a Minnesota community with known drinking water contamination. *J Environ Health* 77(5):14-19.
- +Lau C, Thibodeaux JR, Hanson RG, et al. 2003. Exposure to perfluorooctane sulfonate during pregnancy in rat and mouse. II: Postnatal evaluation. *Toxicol Sci* 74(2):382-392.
- +Lau C, Thibodeaux JR, Hanson RG, et al. 2006. Effects of perfluorooctanoic acid exposure during pregnancy in the mouse. *Toxicol Sci* 90(2):510-518.
- Lee CK, Kang SG, Lee JT, et al. 2015a. Effects of perfluorooctane sulfuric acid on placental PRL-family hormone production and fetal growth retardation in mice. *Mol Cell Endocrinol* 401:165-172. 10.1016/j.mce.2014.10.026.
- Lee ES, Han S, Oh JE. 2016. Association between perfluorinated compound concentrations in cord serum and birth weight using multiple regression models. *Reprod Toxicol* 59:53-59. 10.1016/j.reprotox.2015.10.020.
- Lee YJ, Kim M-K, Bae J, et al. 2013. Concentrations of perfluoroalkyl compounds in maternal and umbilical cord sera and birth outcomes in Korea. *Chemosphere* 90(5):1603-1609.
- Lee YY, Wong CK, Oger C, et al. 2015b. Prenatal exposure to the contaminant perfluorooctane sulfonate elevates lipid peroxidation during mouse fetal development but not in the pregnant dam. *Free Radic Res* 49(8):1015-1025. 10.3109/10715762.2015.1027199.
- +Lefebvre DE, Curran I, Armstrong C, et al. 2008. Immunomodulatory effects of dietary potassium perfluorooctane sulfonate (PFOS) exposure in adult Sprague-Dawley rats. *J Toxicol Environ Health A* 71(23):1516-1525.
- Lemieux P, Strynar M, Tabor D, et al. 2007. Emissions of fluorinated compounds from the combustion of carpeting. In: International conference on incineration and thermalk treatment technologies. May 14-18, 2007. Phoenix, Arizona. U.S. Environmental Protection Agency. <http://www.epa.gov/nhsrc/pubs/paperFluorCompounds101007.pdf>. December 7, 2009.
- Lenters V, Portengen L, Rignell-Hydbom A, et al. 2016a. Prenatal phthalate, perfluoroalkyl acid, and organochlorine exposures and term birth weight in three birth cohorts: Multi-pollutant models based on elastic net regression. *Environ Health Perspect* 124(3):365-372. 10.1289/ehp.1408933.
- Lenters V, Portengen L, Rignell-Hydbom A, et al. 2016b. Supplemental material to prenatal phthalate, perfluoroalkyl acid, and organochlorine exposures and term birth weight in three birth cohorts: Multi-pollutant models based on elastic net regression. [*Environ Health Perspect* 124(3):365-372]. 10.1289/ehp.1408933.
- Leonard RC. 2006. Ammonium perfluorooctanoate: Phase II. Retrospective cohort mortality analyses related to a serum biomarker of exposure in a polymer production plant. Wilmington, DE: E.I. du pont de Nemours and Company.
- Leonard RC, Kreckmann KH, Sakr CJ, et al. 2008. Retrospective cohort mortality study of workers in a polymer production plant including a reference population of regional workers. *Ann Epidemiol* 18:15-22.
- Lewis RC, Johns LE, Meeker JD. 2015. Serum biomarkers of exposure to perfluoroalkyl substances in relation to serum testosterone and measures of thyroid function among adults and adolescents from NHANES 2011-2012. *Int J Environ Res Public Health* 12(6):6098-6114.
- Li L, Zhai Z, Liu J, et al. 2015. Estimating industrial and domestic environmental releases of perfluorooctanoic acid and its salts in China from 2004 to 2012. *Chemosphere* 129:100-109. 10.1016/j.chemosphere.2014.11.049.

8. REFERENCES

- Li N, Hartley DP, Cherrington NJ, et al. 2002. Tissue expression, ontogeny, and inducibility of rat organic anion transporting polypeptide. *J Pharmacol Exp Ther* 301(2):551-560.
- +Li X, Ye L, Ge Y, et al. 2016. *In utero* perfluorooctane sulfonate exposure causes low body weights of fetal rats: A mechanism study. *Placenta* 39:125-133. 10.1016/j.placenta.2016.01.010.
- Li Y, Fletcher T, Mucs D, et al. 2018. Half-lives of PFOS, PFHxS and PFOA after end of exposure to contaminated drinking water. *Occup Environ Med* 75(1):46-51. 10.1136/oemed-2017-104651.
- Li Y, Ramdhan DH, Naito H, et al. 2011. Ammonium perfluorooctanoate may cause testosterone reduction by adversely affecting testis in relation to PPAR α . *Toxicol Lett* 205(3):265-272. <http://dx.doi.org/10.1016/j.toxlet.2011.06.015>.
- Lide DR. 2005. Pentadecafluorooctanoic acid, nonadecafluorodecanoic acid, and heptafluorobutanoic acid. In: *CRC handbook of chemistry and physics*. 86th ed. Boca Raton, FL: Taylor and Francis, 3-412, 3-372, 3-398.
- +Lieder PH, Chang SC, York RG, et al. 2009a. Toxicological evaluation of potassium perfluorobutanesulfonate in a 90-day oral gavage study with Sprague-Dawley rats. *Toxicology* 255:45-52.
- +Lieder PH, York RG, Hakes DC, et al. 2009b. A two-generation oral gavage reproduction study with potassium perfluorobutanesulfonate (K⁺PFBS) in Sprague-Dawley rats. *Toxicology* 259:33-45.
- Lien GW, Huang CC, Shiu JS, et al. 2016. Perfluoroalkyl substances in cord blood and attention deficit/hyperactivity disorder symptoms in seven-year-old children. *Chemosphere* 156:118-127. 10.1016/j.chemosphere.2016.04.102.
- Lien GW, Huang CC, Wu KY, et al. 2013. Neonatal-maternal factors and perfluoroalkyl substances in cord blood. *Chemosphere* 92(7):843-850.
- Liew Z, Ritz B, Bonfeld-Jorgensen EC, et al. 2014. Prenatal exposure to perfluoroalkyl substances and the risk of congenital cerebral palsy in children. *Am J Epidemiol* 180(6):574-581. 10.1093/aje/kwu179.
- Liew Z, Ritz B, von Ehrenstein OS, et al. 2015. Attention deficit/hyperactivity disorder and childhood autism in association with prenatal exposure to perfluoroalkyl substances: A nested case-control study in the Danish National Birth Cohort. *Environ Health Perspect* 123(4):367-373. 10.1289/ehp.1408412.
- Lim TC, Wang B, Huang J, et al. 2011. Emission inventory for PFOS in China: Review of past methodologies and suggestions. *Sci World J* 11:1963-1980.
- Lin CY, Chen PC, Lin YC, et al. 2009. Association among serum perfluoroalkyl chemicals, glucose homeostasis, and metabolic syndrome in adolescents and adults. *Diabetes Care* 32(4):702-707.
- Lin CY, Lin LY, Chiang CK, et al. 2010. Investigation of the associations between low-dose serum perfluorinated chemicals and liver enzymes in US adults. *Am J Gastroenterol* 105(6):1354-1363.
- Lin CY, Lin LY, Wen TW, et al. 2013a. Association between levels of serum perfluorooctane sulfate and carotid artery intima-media thickness in adolescents and young adults. *Int J Cardiol* 168(4):3309-3316. 10.1016/j.ijcard.2013.04.042.
- Lin CY, Lin LY, Wen TW, et al. 2013b. Supplemental material: Association between levels of serum perfluorooctane sulfate and carotid artery intima-media thickness in adolescents and young adults. *Int J Cardiol* 168:3309-3316.
- Lin LY, Wen LL, Su TC, et al. 2014. Negative association between serum perfluorooctane sulfate concentration and bone mineral density in US premenopausal women: NHANES, 2005-2008. *The Journal of clinical endocrinology and metabolism* 99(6):2173-2180. 10.1210/jc.2013-3409.
- Lind L, Zethelius B, Salihovic S, et al. 2014. Circulating levels of perfluoroalkyl substances and prevalent diabetes in the elderly. *Diabetologia* 57(3):473-479. 10.1007/s00125-013-3126-3.
- Lindstrom AB, Strynar MJ, Delinsky AD, et al. 2011. Application of WWTP biosolids and resulting perfluorinated compound contamination of surface and well water in Decatur, Alabama, USA. *Environ Sci Technol* 45:8015-8021.
- Liu J, Li J, Liu Y, et al. 2011. Comparison on gestation and lactation exposure of perfluorinated compounds for newborns. *Environ Int* 37(7):1206-1212.

8. REFERENCES

- Liu J, Lee LS, Nies LF, et al. 2007. Biotransformation of 8:2 fluorotelomer alcohol in soil and by soil bacteria isolates. *Environ Sci Technol* 41:8024-8030.
- Liu L, Liu W, Song J, et al. 2009. A comparative study on oxidative damage and distributions of perfluorooctane sulfonate (PFOS) in mice at different postnatal developmental stages. *J Toxicol Sci* 34(3):245-254.
- +Liu RCM, Hurtt ME, Cook JC, et al. 1996. Effect of the peroxisome proliferator, ammonium perfluorooctanoate (C8), on hepatic aromatase activity in adult male Crl:CD BR (CD) rats. *Toxicol Sci* 30(2):220-228.
- Liu W, Li X, Xu L, et al. 2010. Influence of gestation, regular bleeding and intermittent exposure on blood perfluorooctane sulfonate levels in mice: Potential factors inducing sex difference and affecting exposure evaluation. *J Toxicol Sci* 35(3):309-316.
- Liu X, Guo Z, Krebs KA, et al. 2014. Concentrations and trends of perfluorinated chemicals in potential indoor sources from 2007 through 2011 in the US. *Chemosphere* 98:51-57. 10.1016/j.chemosphere.2013.10.001.
- Llorca M, Farre M, Pico Y, et al. 2010. Infant exposure of perfluorinated compounds: Levels in breast milk and commercial baby food. *Environ Int* 36(6):584-592.
- Loccisano AE, Campbell JL, Jr., Andersen ME, et al. 2011. Evaluation and prediction of pharmacokinetics of PFOA and PFOS in the monkey and human using a PBPK model. *Regul Toxicol Pharmacol* 59(1):157-175.
- Loccisano AE, Campbell JL, Jr., Butenhoff JL, et al. 2012a. Comparison and evaluation of pharmacokinetics of PFOA and PFOS in the adult rat using a physiologically based pharmacokinetic model. *Reprod Toxicol* 33(4):452-467.
- Loccisano AE, Campbell JL, Jr., Butenhoff JL, et al. 2012b. Evaluation of placental and lactational pharmacokinetics of PFOA and PFOS in the pregnant, lactating, fetal and neonatal rat using a physiologically based pharmacokinetic model. *Reprod Toxicol* 33(4):468-490.
- Loccisano AE, Longnecker MP, Campbell JL, Jr., et al. 2013. Development of PBPK models for PFOA and PFOS for human pregnancy and lactation life stages. *J Toxicol Environ Health A* 76(1):25-57.
- Loewen M, Halldorson T, Wang F, et al. 2005. Fluorotelomer carboxylic acids and PFOS in rainwater from an urban center in Canada. *Environ Sci Technol* 39:2944-2951.
- Loganathan BG, Sajwan KS, Sinclair E, et al. 2007. Perfluoroalkyl sulfonates and perfluorocarboxylates in two wastewater treatment facilities in Kentucky and Georgia. *Water Res* 41(20):4611-4620. doi.org/10.1016/j.watres.2007.06.045.
- +Long Y, Wang Y, Ji G, et al. 2013. Neurotoxicity of perfluorooctane sulfonate to hippocampal cells in adult mice. *PLoS ONE* 8(1):e54176.
- Looker C, Luster MI, Calafat AM, et al. 2014. Influenza vaccine response in adults exposed to perfluorooctanoate and perfluorooctanesulfonate. *Toxicol Sci* 138(1):76-88.
- Loos R, Locoro G, Huber T, et al. 2008. Analysis of perfluorooctanoate (PFOA) and other perfluorinated compounds (PFCs) in the River Po watershed in N-Italy. *Chemosphere* 71:306-313.
- López-Doval S, Salgado R, Pereiro N, et al. 2014. Perfluorooctane sulfonate effects on the reproductive axis in adult male rats. *Environ Res* 134:158-168.
- Lopez-Espinosa MJ, Fletcher T, Armstrong B, et al. 2011. Association of perfluorooctanoic acid (PFOA) and perfluorooctane sulfonate (PFOS) with age of puberty among children living near a chemical plant. *Environ Sci Technol* 45(19):8160-8166.
- Lopez-Espinosa MJ, Mondal D, Armstrong B, et al. 2012. Thyroid function and perfluoroalkyl acids in children living near a chemical plant. *Environ Health Perspect* 120(7):1036-1041. 10.1289/ehp.1104370.
- +Lopez-Espinosa MJ, Mondal D, Armstrong BG, et al. 2016. Perfluoroalkyl substances, sex hormones, and insulin-like growth factor-1 at 6-9 years of age: A Cross-sectional analysis within the C8 Health Project. *Environ Health Perspect* 124:1269-1275. 10.1289/ehp.1509869.

8. REFERENCES

- Lorber M, Egeghy PP. 2011. Simple intake and pharmacokinetic modeling to characterize exposure of Americans to perfluorooctanoic acid, PFOA. *Environ Sci Technol* 45(19):8006-8014. 10.1021/es103718h.
- Lou I, Wambaugh JF, Lau C, et al. 2009. Modeling single and repeated dose pharmacokinetics of PFOA in mice. *Toxicol Sci* 107(2):331-341.
- Loveless SE, Finlay C, Everds NE, et al. 2006. Comparative responses of rats and mice exposed to linear/branched, linear, or branched ammonium perfluorooctanoate (APFO). *Toxicology* 220:203-217.
- +Loveless SE, Hoban D, Sykes G, et al. 2008. Evaluation of the immune system in rats and mice administered linear ammonium perfluorooctanoate. *Toxicol Sci* 105(1):86-96.
- Lu R, Kanai N, Bao Y, et al. 1996. Regulation of renal oatp mRNA expression by testosterone. *Am J Physiol* 270:F332-F337.
- Lubojevic M, Herak-Kramberger CM, Hagos Y, et al. 2004. Rat renal cortical OAT1 and OAT3 exhibit gender differences determined by both androgen stimulation and estrogen inhibition. *Am J Physiol* 287:F124-F138.
- +Luebker DJ, Case MT, York RG, et al. 2005a. Two-generation reproduction and cross-foster studies of perfluorooctanesulfonate (PFOS) in rats. *Toxicology* 215(1-2):126-148.
- Luebker DJ, Hansen KJ, Bass NM, et al. 2002. Interactions of fluorochemicals with rat liver fatty acid-binding protein. *Toxicology* 176:175-185.
- +Luebker DJ, York RG, Hansen KJ, et al. 2005b. Neonatal mortality from *in utero* exposure to perfluorooctanesulfonate (PFOS) in Sprague-Dawley rats: Dose-response, and biochemical and pharmacokinetic parameters. *Toxicology* 215(1-2):149-169.
- Lundin JI, Alexander BH, Olsen GW, et al. 2009. Ammonium perfluorooctanoate production and occupational mortality. *Epidemiology* 20(6):921-928.
- Luo Z, Shi X, Hu Q, et al. 2012. Structural evidence of perfluorooctane sulfonate transport by human serum albumin. *Chem Res Toxicol* 25(5):990-992.
- Lv Z, Li G, Li Y, et al. 2013. Glucose and lipid homeostasis in adult rat is impaired by early-life exposure to perfluorooctane sulfonate. *Environ Toxicol* 28(9):532-542.
- +Lv QY, Wan B, Guo LH, et al. 2015. *In vivo* immunotoxicity of perfluorooctane sulfonate in BALB/c mice: Identification of T-cell receptor and calcium-mediated signaling pathway disruption through gene expression profiling of the spleen. *Chem Biol Interact* 240:84-93. 10.1016/j.cbi.2015.07.015.
- Lyngsø J, Ramlau-Hansen CH, Hoyer BB, et al. 2014. Menstrual cycle characteristics in fertile women from Greenland, Poland and Ukraine exposed to perfluorinated chemicals: A cross-sectional study. *Human reproduction (Oxford, England)* 29(2):359-367. 10.1093/humrep/det390.
- MacNeil J, Steenland NK, Shankar A, et al. 2009. A cross-sectional analysis of type II diabetes in a community with exposure to perfluorooctanoic acid (PFOA). *Environ Res* 109(8):997-1003.
- +Macon MB, Villanueva LR, Tatum-Gibbs K, et al. 2011. Prenatal perfluorooctanoic acid exposure in CD-1 mice: Low-dose developmental effects and internal dosimetry. *Toxicol Sci* 122(1):134-145.
- MacPherson IR, Bissett D, Petty RD, et al. 2011. A first-in-human phase I clinical trial of CXR1002 in patients (pts) with advanced cancer. *J Clin Oncol* 29(Suppl; abstr 3063).
- Maestri L, Negri S, Ferrari M, et al. 2006. Determination of perfluorooctanoic acid and perfluorooctanesulfonate in human tissues by liquid chromatography/single quadrupole mass spectrometry. *Rapid Commun Mass Spectrom* 20(18):2728-2734.
- Maher JM, Aleksunes LM, Dieter MZ, et al. 2008. Nrf2- and PPAR α -mediated regulation of hepatic Mrp transporters after exposure to perfluorooctanoic acid and perfluorodecanoic acid. *Toxicol Sci* 106(2):319-328. 10.1093/toxsci/kfn177.
- Maisonet M, Terrell ML, McGeehin MA, et al. 2012. Maternal concentrations of polyfluoroalkyl compounds during pregnancy and fetal and postnatal growth in British girls. *Environ Health Perspect* 120(10):1432-1437.

8. REFERENCES

- Maisonet M, Calafat AM, Marcus M, et al. 2015a. Prenatal exposure to perfluoroalkyl acids and serum testosterone concentrations at 15 years of age in female ALSPAC study participants. *Environ Health Perspect* 123(12):1325-1330. 10.1289/ehp.1408847.
- Maisonet M, Nayha S, Lawlor DA, et al. 2015b. Prenatal exposures to perfluoroalkyl acids and serum lipids at ages 7 and 15 in females. *Environ Int* 82:49-60. 10.1016/j.envint.2015.05.001.
- Mak YL, Taniyasu S, Yeung LW, et al. 2009. Perfluorinated compounds in tap water from China and several other countries. *Environ Sci Technol* 43(13):4824-4829.
- Maloney EK, Waxman DJ. 1999. *trans*-Activation of PPAR α and PPAR γ by structurally diverse environmental chemicals. *Toxicol Appl Pharmacol* 161:209-218.
- Mann PC, Frame SR. 2004. FC-143: Two year oral toxicity-oncogenicity study in rats. Peer review of ovaries. Newark, DE: E.I. du Pont de Nemours and Company. Du Pont Project ID 15261. U.S. EPA AR226.
- Manzano-Salgado CB, Casas M, Lopez-Espinosa MJ, et al. 2015. Transfer of perfluoroalkyl substances from mother to fetus in a Spanish birth cohort. *Environ Res* 142:471-478. 10.1016/j.envres.2015.07.020
- Martin JW, Ellis DA, Mabury SA. 2006. Atmospheric chemistry of perfluoroalkanesulfonamides: Kinetic and product studies of the OH radical and Cl atom initiated oxidation of N-ethyl perfluorobutanesulfonamide. *Environ Sci Technol* 40:864-872.
- Martin JW, Smithwick MM, Braune BM, et al. 2004a. Identification of long-chain perfluorinated acids in biota from the Canadian Arctic. *Environ Sci Technol* 38(2):373-380.
- Martin JW, Whittle DM, Muir DCG, et al. 2004b. Perfluoroalkyl contaminants in a food web from Lake Ontario. *Environ Sci Technol* 38:5379-5385.
- Martin MT, Brennan RJ, Hu W, et al. 2007. Toxicogenomic study of triazole fungicides and perfluoroalkyl acids in rat livers predicts toxicity and categorizes chemicals based on mechanisms of toxicity. *Toxicol Sci* 97:595-613.
- Mattsson K, Rignell-Hydbom A, Holmberg S, et al. 2015. Levels of perfluoroalkyl substances and risk of coronary heart disease: Findings from a population-based longitudinal study. *Environ Res* 142:148-154. 10.1016/j.envres.2015.06.033.
- MDH. 2007. Groundwater health risk limits. St. Paul, MN: Minnesota Department of Health. <http://www.health.state.mn.us/divs/eh/groundwater/hrltable.html>. July 1, 2008.
- MDH. 2009. East Metro perfluorochemical biomonitoring pilot project. Minnesota Department of Health, Minnesota Environment, Exposure and Health. <http://www.health.state.mn.us/divs/hpcd/tracking/biomonitoring/projects/pfcfinalrpt2009.pdf>. May 5, 2014.
- MDH. 2014. Perfluorochemicals in homes and gardens study. Minnesota Department of Health. <http://www.health.state.mn.us/divs/eh/hazardous/topics/pfcs/index.html>.
- MDH. 2017a. Human health-based water guidance table. Saint Paul, Minnesota: Minnesota Department of Health. <http://www.health.state.mn.us/divs/eh/risk/guidance/gw/table.html>. December 18, 2017.
- MDH. 2017b. Perfluorochemicals (PFCs) and health. Saint Paul, Minnesota: Minnesota Department of Health. <http://www.health.state.mn.us/divs/eh/hazardous/topics/pfcshealth.html>. December 18, 2017.
- MECDC. 2016. Maine CDC maximum exposure guidelines (MEGs) for drinking water. Augusta, ME: Maine Center for Disease Control and Prevention. <http://maineenvironmentallaboratory.com/newsite/wp-content/uploads/megtable2016.pdf>. December 18, 2017.
- Meesters RJ, Schröder HF. 2004. Perfluorooctane sulfonate- a quite mobile anionic anthropogenic surfactant, ubiquitously found in the environment. *Water Sci Technol* 50(5):235-242.
- Melzer D, Rice N, Depledge MH, et al. 2010. Association between serum perfluorooctanoic acid (PFOA) and thyroid disease in the U.S. National Health and Nutrition Examination Survey. *Environ Health Perspect* 118(5):686-692.

8. REFERENCES

- Michigan Department of Environmental Quality. 2016. Rule 57 water quality values. Lansing, MI: Michigan Department of Environmental Quality. http://www.michigan.gov/documents/deq/wrd-sw-as-rule57_372470_7.pdf. December 18, 2017.
- Midasch O, Drexler H, Hart N, et al. 2007. Transplacental exposure of neonates to perfluorooctanesulfonate and perfluorooctanoate: A pilot study. *Int Arch Occup Environ Health* 80:643-648.
- Min JY, Lee KJ, Park JB, et al. 2012. Perfluorooctanoic acid exposure is associated with elevated homocysteine and hypertension in US adults. *Occup Environ Med* 69(9):658-662.
- Minata M, Harada KH, Kärrman A, et al. 2010. Role of peroxisome proliferator-activated receptor- α in hepatobiliary injury induced by ammonium perfluorooctanoate in mouse liver. *Ind Health* 48:96-107.
- Mondal D, Lopez-Espinosa MJ, Armstrong B, et al. 2012. Relationships of perfluorooctanoate and perfluorooctane sulfonate serum concentrations between mother-child pairs in a population with perfluorooctanoate exposure from drinking water. *Environ Health Perspect* 120(5):752-757.
- Mondal D, Weldon RH, Armstrong BG, et al. 2014. Breastfeeding: A potential excretion route for mothers and implications for infant exposure to perfluoroalkyl acids. *Environ Health Perspect* 122(2):187-192.
- Monroy R, Morrison K, Teo K, et al. 2008. Serum levels of perfluoroalkyl compounds in human maternal and umbilical cord blood samples. *Environ Res* 108:56-62.
- Moody CA, Field JA. 1999. Determination of perfluorocarboxylates in groundwater impacted by fire-fighting activity. *Environ Sci Technol* 33(16):2800-2806.
- Moody CA, Hebert GN, Strauss SH, et al. 2003. Occurrence and persistence of perfluorooctanesulfonate and other perfluorinated surfactants in groundwater at a fire-training area at Wurtsmith Air Force Base, Michigan, USA. *J Environ Monit* 5:341-345.
- Mogensen UB, Grandjean P, Nielsen F, et al. 2015b. Breastfeeding as an exposure pathway for perfluorinated alkylates. *Environ Sci Technol* 49(17):10466-10473. 10.1021/acs.est.5b02237.
- Mogensen UB, Grandjean P, Heilmann C, et al. 2015a. Structural equation modeling of immunotoxicity associated with exposure to perfluorinated alkylates. *Environ Health* 14:47 10.1186/s12940-015-0032-9.
- Morello-Frosch R, Cushing LJ, Jesdale BM, et al. 2016. Environmental chemicals in an urban population of pregnant women and their newborns from San Francisco. *Environ Sci Technol* 50:12464-12472.
- Moriwaki H, Takata Y, Arakawa R. 2003. Concentrations of perfluorooctane sulfonate (PFOS) and perfluorooctanoic acid (PFOA) in vacuum cleaner dust collected in Japanese homes. *J Environ Monit* 5:753-757.
- Mundt DJ, Mundt KA, Luippold RS, et al. 2007. Clinical epidemiological study of employees exposed to surfactant blend containing perfluorononanoic acid. *Occup Environ Med* 64:589-594.
- Murakami M, Imamura E, Shinohara H, et al. 2008. Occurrence and sources of perfluorinated surfactants in rivers in Japan. *Environ Sci Technol* 42(17):6566-6572.
- Nabb DL, Szostek B, Himmelstein MW, et al. 2007. *In vitro* metabolism of 8-2 fluorotelomer alcohol: Interspecies comparisons and metabolic pathway refinement. *Toxicol Sci* 100(2):333-344.
- Nakagawa H, Hirata T, Terada T, et al. 2008. Roles of organic anion transporters in the renal excretion of perfluorooctanoic acid. *Basic Clin Pharmacol Toxicol* 103(1):1-8.
- Nakagawa H, Terada T, Harada KH, et al. 2009. Human organic anion transporter hOAT4 is a transporter of perfluorooctanoic acid. *Basic Clin Pharmacol Toxicol* 105(2):136-138.
- Nakayama S, Strynar MJ, Helfant L, et al. 2007. Perfluorinated compounds in the Cape Fear drainage basin in North Carolina. *Environ Sci Technol* 41(15):5271-5276.
- Nakagawa T, Ramdhan D, Tanaka N, et al. 2012. Modulation of ammonium perfluorooctanoate-induced hepatic damage by genetically different PPAR α in mice. *Arch Toxicol* 86(1):63-74.

8. REFERENCES

- NAS/NRC. 1989. Report of the oversight committee. In: *Biologic markers in reproductive toxicology*. Washington, DC: National Academy of Sciences, National Research Council, National Academy Press, 15-35.
- NCDENR. 2012. Memorandum: NCSAB recommendation for the revision of the IMAC for perfluorooctanoic acid (PFOA). August 10, 2012. Raleigh, NC: North Carolina Department of Environment and Natural Resources Division of Air Quality. <https://ncdenr.s3.amazonaws.com/s3fs-public/Air%20Quality/toxics/risk/sab/LAA/20120808%20PFOA%20Final%20Risk%20Assessment%20signed.pdf>. December 18, 2017.
- NDEP. 2016. Basic comparison levels. Carson City, NE: Nevada Division of Environmental Protection. <https://ndep.nv.gov/uploads/documents/july-2017-ndep-bcls.pdf>. December 18, 2017.
- Needham LL, Grandjean P, Heinzow B, et al. 2011. Partition of environmental chemicals between maternal and fetal blood and tissues. *Environ Sci Technol* 45(3):1121-1126.
- Nelson JW, Hatch EE, Webster TF. 2010. Exposure to polyfluoroalkyl chemicals and cholesterol, body weight, and insulin resistance in the general U.S. population. *Environ Health Perspect* 118(2):197-202.
- +Ngo HT, Hetland RB, Sabaredzovic A, et al. 2014. *In utero* exposure to perfluorooctanoate (PFOA) or perfluorooctane sulfonate (PFOS) did not increase body weight or intestinal tumorigenesis in multiple intestinal neoplasia (Min/+) mice. *Environ Res* 132:251-263. 10.1016/j.envres.2014.03.033.
- Nilsson R, Beije B, Preat V, et al. 1991. On the mechanism of the hepatocarcinogenicity of peroxisome proliferations. *Chem Biol Interact* 78:235-250.
- NIOSH. 2016. Index of Chemical Abstracts Service Registry Numbers (CAS No.). NIOSH pocket guide to chemical hazards. Index of Chemical Abstracts Service Registry Numbers (CAS No.). Atlanta, GA: National Institute for Occupational Safety and Health, Centers for Disease Control and Prevention. <https://www.cdc.gov/niosh/npg/npgdcas.html>. February 28, 2017.
- Noker PE, Gorman GS. 2003. A pharmacokinetic study of potassium perfluorooctanesulfonate in the Cynomolgus monkey. St. Paul, MN: 3M Corporation.
- Nolan LA, Nolan JM, Shofer FS, et al. 2009. The relationship between birth weight, gestational age and perfluorooctanoic acid (PFOA)-contaminated public drinking water. *Reprod Toxicol* 27:231-238.
- Nolan LA, Nolan JM, Shofer FS, et al. 2010. Congenital anomalies, labor/delivery complications, maternal risk factors and their relationship with perfluorooctanoic acid (PFOA)-contaminated public drinking water. *Reprod Toxicol* 29(2):147-155.
- North Carolina Department of Environmental Quality. 2013. Appendix 1: Interim maximum allowable concentrations (IMACs). Raleigh, NC: North Carolina Department of Environmental Quality. https://files.nc.gov/ncdeq/documents/files/IMAC%20table_5-22-13.pdf. December 19, 2017.
- NTP. 2016a. CASRN Index in MS Excel. Report on carcinogens, Fourteenth Edition. Research Triangle Park, NC: U.S. Department of Health and Human Services, Public Health Service, National Toxicology Program. <https://ntp.niehs.nih.gov/pubhealth/roc/index-1.html#P>. February 28, 2017.
- NTP. 2016b. NTP Monograph on immunotoxicity associated with exposure to perfluorooctanoic acid (PFOA) and perfluorooctane sulfonate (PFOS). Research Triangle Park, NC: U.S. Department of Health and Human Services, Public Health Service, National Toxicology Program. https://ntp.niehs.nih.gov/ntp/ohat/pfoa_pfos/pfoa_pfosmonograph_508.pdf. December 21, 2017.
- Oda Y, Nakayama S, Harada KH, et al. 2007. Negative results of *umu* genotoxicity test of fluorotelomer alcohols and perfluorinated alkyl acids. *Environ Health Prev Med* 12:217-219.
- Ode A, Kallen K, Gustafsson P, et al. 2014. Fetal exposure to perfluorinated compounds and attention deficit hyperactivity disorder in childhood. *PLoS ONE* 9(4):e95891. 10.1371/journal.pone.0095891.
- Ode A, Rylander L, Lindh CH, et al. 2013. Determinants of maternal and fetal exposure and temporal trends of perfluorinated compounds. *Environ Sci Pollut Res Int* 20(11):7970-7978.

8. REFERENCES

- OECD. 2002. Hazard assessment of perfluorooctane sulfonate (PFOS) and its salts. Organisation for Economic Co-operation and Development. ENV/JM/RD(2002)17/FINAL. <http://www.oecd.org/dataoecd/23/18/2382880.pdf>. July 02, 2007.
- OECD. 2006a. Results of the 2006 survey on production and use of PFOS, PFAS, PFOA, PFCA, their related substances and products/mixtures containing these substances. Organisation for Economic Co-operation and Development.
- OECD. 2006b. SIDS initial assessment report after SIAM 22. Ammonium perfluorooctanoate and perfluorooctanoic acid. Organisation for Economic Co-operation and Development. http://www.oecd.org/document/63/0,3343,en_2649_34379_1897983_1_1_1_1,00.html. May 18, 2009.
- OECD. 2007. Report of an OECD workshop on perfluorocarboxylic acids (PFCAs) and precursors. Organisation for Economic Co-operation and Development. [http://www.olis.oecd.org/olis/2007doc.nsf/LinkTo/NT00002AB6/\\$FILE/JT03229256.PDF](http://www.olis.oecd.org/olis/2007doc.nsf/LinkTo/NT00002AB6/$FILE/JT03229256.PDF). April 02, 2008.
- Ohmori K, Kudo N, Katayama K, et al. 2003. Comparison of the toxicokinetics between perfluorocarboxylic acids with different carbon chain length. *Toxicology* 184:135-140.
- Okada E, Sasaki S, Saijo Y, et al. 2012. Prenatal exposure to perfluorinated chemicals and relationship with allergies and infectious diseases in infants. *Environ Res* 112:118-125.
- Okada E, Sasaki S, Kashino I, et al. 2014. Prenatal exposure to perfluoroalkyl acids and allergic diseases in early childhood. *Environ Int* 65:127-134. 10.1016/j.envint.2014.01.007.
- Olsen GW. 2015. PFAS biomonitoring in higher exposed populations, Chapter 4. In: Dewitt JC, ed. *Toxicological effects on perfluoroalkyl and polyfouroalkyl substances*. London: Humana Press, 77-125.
- Olsen GW, Zobel LR. 2007. Assessment of lipid, hepatic, and thyroid parameters with serum perfluorooctanoate (PFOA) concentrations in fluorochemical production workers. *Int Arch Occup Environ Health* 81:231-246.
- Olsen GW, Burlew MM, Marshall JC, et al. 2004a. Analysis of episodes of care in a perfluorooctanesulfonyl fluoride production facility. *J Occup Environ Hyg* 46(8):837-846.
- Olsen GW, Burris JM, Burlew MM, et al. 2003a. Epidemiologic assessment of worker serum perfluorooctanesulfonate (PFOS) and perfluorooctanoate (PFOA) concentrations and medical surveillance examinations. *J Occup Environ Med* 45(3):260-270.
- Olsen GW, Burris JM, Burlew MM, et al. 2000. Plasma cholecystokinin and hepatic enzymes, cholesterol and lipoproteins in ammonium perfluorooctanoate production workers. *Drug Chem Toxicol* 23(4):603-620.
- Olsen GW, Burris JM, Ehresman DJ, et al. 2007a. Half-life of serum elimination of perfluorooctanesulfonate, perfluorohexanesulfonate, and perfluorooctanoate in retired fluorochemical production workers. *Environ Health Perspect* 115:1298-1305.
- Olsen GW, Burris JM, Mandel JH, et al. 1998a. An epidemiologic investigation of clinical chemistries, hematology and hormones in relation to serum levels of perfluorooctane sulfonate in male fluorochemical production employees. St. Paul, MN: 3M Company. AR226-0030.
- Olsen GW, Burris JM, Mandel JH, et al. 1999. Serum perfluorooctane sulfonate and hepatic and lipid clinical chemistry tests in fluorochemical production employees. *J Occup Environ Med* 41(9):799-806.
- Olsen GW, Butenhoff JL, Zobel LR. 2009. Perfluoroalkyl chemicals and human fetal development: An epidemiologic review with clinical and toxicological perspectives. *Reprod Toxicol* 27(3-4):212-230.
- Olsen GW, Church TR, Hansen KJ, et al. 2004b. Quantitative evaluation of perfluorooctanesulfonate (PFOS) and other fluorochemicals in the serum of children. *J Child Health* 2(1):53-76.
- Olsen GW, Church TR, Larson EB, et al. 2004c. Serum concentrations of perfluorooctanesulfonate and other fluorochemicals in an elderly population from Seattle, Washington. *Chemosphere* 54:1599-1611.

8. REFERENCES

- Olsen GW, Church TR, Miller JP, et al. 2003b. Perfluorooctanesulfonate and other fluorochemicals in the serum of American Red Cross adult blood donors. *Environ Health Perspect* 111:1892-1901.
- Olsen GW, Ehresman DJ, Buehrer BD, et al. 2012. Longitudinal assessment of lipid and hepatic clinical parameters in workers involved with the demolition of perfluoroalkyl manufacturing facilities. *J Occup Environ Med* 54(8):974-983.
- Olsen GW, Gilliland FD, Burlew MM, et al. 1998b. An epidemiologic investigation of reproductive hormones in men with occupational exposure to perfluorooctanoic acid. *J Occup Environ Med* 40(7):614-622.
- Olsen GW, Hansen KJ, Stevenson LA, et al. 2003c. Human donor liver and serum concentrations of perfluorooctanesulfonate and other perfluorochemicals. *Environ Sci Technol* 37:888-891.
- Olsen GW, Huang HY, Helzlsouer KJ, et al. 2005. Historical comparison of perfluorooctanesulfonate, perfluorooctanoate, and other fluorochemicals in human blood. *Environ Health Perspect* 113(5):539-545.
- Olsen GW, Mair DC, Church TR, et al. 2008. Decline in perfluorooctanesulfonate and other polyfluoroalkyl chemicals in American Red Cross adult blood donors, 2000-2006. *Environ Sci Technol* 42(13):4989-4995.
- Olsen GW, Mair DC, Lange CC, et al. 2017a. Per- and polyfluoroalkyl substances (PFAS) in American Red Cross adult blood donors, 2000-2015. *Environ Res* 157:87-95. 10.1016/j.envres.2017.05.013.
- Olsen GW, Mair DC, Lange CC, et al. 2017b. Supplemental file. Per-and polyfluoroalkyl substances (PFAS) in American Red Cross adult blood donors, 2000-2015 [Environ Res 157:87-95]. *Environ Res* 10.1016/j.envres.2017.05.013.
- Olsen GW, Mair DC, Reagan WK, et al. 2007b. Preliminary evidence of a decline in perfluorooctanesulfonate (PFOS) and perfluorooctanoate (PFOA) concentrations in American Red Cross blood donors. *Chemosphere* 68(1):105-111.
- +Onishchenko N, Fischer C, Wan Ibrahim WN, et al. 2011. Prenatal exposure to PFOS or PFOA alters motor function in mice in a sex-related manner. *Neurotox Res* 19(3):452-461.
- Orata F, Quinete N, Werres F, et al. 2009. Determination of perfluorooctanoic acid and perfluorooctane sulfonate in Lake Victoria Gulf water. *Bull Environ Contam Toxicol* 82:218-222.
- OSHA. 2013. Subpart Z - Toxic and hazardous substances. Air contaminants. Occupational Safety and Health Standards. Code of Federal Regulations 29 CFR 1910.1000. <http://www.gpo.gov/fdsys/pkg/CFR-2014-title29-vol6/pdf/CFR-2014-title29-vol6-sec1910-1000.pdf>. March 4, 2015.
- OSHA. 2014a. Appendix A to Part 1926.55-1970 American Conference of Governmental Industrial Hygienists' threshold limit values of airborne contaminants. Occupational Safety and Health Standards. Code of Federal Regulations 29 CFR 1926.55 <http://www.gpo.gov/fdsys/pkg/CFR-2014-title29-vol8/pdf/CFR-2014-title29-vol8-sec1926-55.pdf>. March 4, 2015.
- OSHA. 2014b. Subpart Z - Toxic and hazardous substances. Air contaminants. Table Z - Shipyards. Occupational Safety and Health Standards. Code of Federal Regulations 29 CFR 1915.1000. <http://www.gpo.gov/fdsys/pkg/CFR-2013-title29-vol7/pdf/CFR-2013-title29-vol7-sec1915-1000.pdf>. March 4, 2015.
- Osuna CE, Grandjean P, Weihe P, et al. 2014. Autoantibodies associated with prenatal and childhood exposure to environmental chemicals in Faroese children. *Toxicol Sci* 142(1):158-166. 10.1093/toxsci/kfu163.
- +Pastoor TP, Lee KP, Perri MA, et al. 1987. Biochemical and morphological studies of ammonium perfluorooctanoate-induced hepatomegaly and peroxisome proliferation. *Exp Mol Pathol* 47(1):98-109.
- Paustenbach DJ, Panko JM, Scott PK, et al. 2007. A methodology for estimating human exposure to perfluorooctanoic acid (PFOA): A retrospective exposure assessment of a community (1951-2003). *J Toxicol Environ Health A* 70(1):28-57.
- +Peden-Adams MM, Keller JM, Eudaly JG, et al. 2008. Suppression of humoral immunity in mice following exposure to perfluorooctane sulfonate. *Toxicol Sci* 104(1):144-154.

8. REFERENCES

- +Pereiro N, Moyano R, Blanco A, et al. 2014. Regulation of corticosterone secretion is modified by PFOS exposure at different levels of the hypothalamic-pituitary-adrenal axis in adult male rats. *Toxicol Lett* 230(2):252-262. 10.1016/j.toxlet.2014.01.003.
- Perez F, Nadal M, Navarro-Ortega A, et al. 2013. Accumulation of perfluoroalkyl substances in human tissues. *Environ Int* 59:354-362. 10.1016/j.envint.2013.06.004.
- +Perkins RG, Butenhoff JL, Kennedy GL, et al. 2004. 13-Week dietary toxicity study of ammonium perfluorooctanoate (APFO) in male rats. *Drug Chem Toxicol* 27(4):361-378.
- +Permadi H, Lundgren B, Andersson K, et al. 1992. Effects of perfluoro fatty acids on xenobiotic-metabolizing enzymes, enzymes which detoxify reactive forms of oxygen and lipid peroxidation in mouse liver. *Biochem Pharmacol* 44(6):1183-1191.
- +Permadi H, Lundgren B, Andersson K, et al. 1993. Effects of perfluoro fatty acids on peroxisome proliferation and mitochondrial size in mouse liver: Dose and time factors and effect of chain length. *Xenobiotica* 23(7):761-770.
- Peters JM, Gonzalez FJ. 2011. Why toxic equivalency factors are not suitable for perfluoroalkyl chemicals. American Chemical Society. *Chem Res Toxicol* 24(10):1601-1609. 10.1021/tx200316x.
- Pinney SM, Biro FM, Windham GC, et al. 2014. Serum biomarkers of polyfluoroalkyl compound exposure in young girls in Greater Cincinnati and the San Francisco Bay Area, USA. *Environ Pollut* 184:327-334. 10.1016/j.envpol.2013.09.008.
- Plastics Europe. 2012. Guide for the safe handling of fluoropolymer resins, November 2012. Plastics Europe, Association of Plastics Manufacturers.
- Porpora MG, Lucchini R, Abballe A, et al. 2013. Placental transfer of persistent organic pollutants: A preliminary study on mother-newborn pairs. *Int J Environ Res Public Health* 10(2):699-711.
- Post GB, Louis JB, Cooper KR, et al. 2009. Occurrence and potential significance of perfluorooctanoic acid (PFOA) detected in New Jersey public drinking water systems. *Environ Sci Technol* 43(12):4547-4554.
- Post GB, Louis JB, Lippincott RL, et al. 2013. Occurrence of perfluorinated compounds in raw water from New Jersey public drinking water systems. *Environ Sci Technol* 47(23):13266-13275. 10.1021/es402884x.
- Power MC, Webster TF, Baccarelli AA, et al. 2013. Cross-sectional association between polyfluoroalkyl chemicals and cognitive limitation in the National Health and Nutrition Examination Survey. *Neuroepidemiology* 40(2):125-132.
- Powley CR, George SW, Russell MH, et al. 2008. Polyfluorinated chemicals in a spatially and temporally integrated food web in the Western Arctic. *Chemosphere* 70:664-672.
- Powley CR, Michalczyk MJ, Kaiser MA, et al. 2005. Determination of perfluorooctanoic acid (PFOA) extractable from the surface of commercial cookware under simulated cooking conditions by LC/MS/MS. *Analyst* 130(9):1299-1302.
- Predieri B, Iughetti L, Guerranti C, et al. 2015. High levels of perfluorooctane sulfonate in children at the onset of diabetes. *Int J Endocrinol* 2015:234358. 10.1155/2015/234358.
- Prevedouros K, Cousins I T, Buck RC, et al. 2006. Sources, fate and transport of perfluorocarboxylates. *Environ Sci Technol* 40(1):32-44.
- Qazi MR, Abedi MR, Nelson BD, et al. 2010a. Dietary exposure to perfluorooctanoate or perfluorooctane sulfonate induces hypertrophy in centrilobular hepatocytes and alters the hepatic immune status in mice. *Int Immunopharmacol* 10(11):1420-1427.
- +Qazi MR, Nelson BD, Depierre JW, et al. 2010b. 28-Day dietary exposure of mice to a low total dose (7 mg/kg) of perfluorooctanesulfonate (PFOS) alters neither the cellular compositions of the thymus and spleen nor humoral immune responses: Does the route of administration play a pivotal role in PFOS-induced immunotoxicity? *Toxicology* 267(1-3):132-139. 10.1016/j.tox.2009.10.035.

8. REFERENCES

- Qazi MR, Bogdanska J, Butenhoff JL, et al. 2009a. High-dose, short-term exposure of mice to perfluorooctanesulfonate (PFOS) or perfluorooctanoate (PFOA) affects the number of circulating neutrophils differently, but enhances the inflammatory responses of macrophages to lipopolysaccharide (LPS) in a similar fashion. *Toxicology* 262(3):207-214.
- Qazi MR, Nelson BD, DePierre JW, et al. 2012. High-dose dietary exposure of mice to perfluorooctanoate or perfluorooctane sulfonate exerts toxic effects on myeloid and B-lymphoid cells in the bone marrow and these effects are partially dependent on reduced food consumption. *Food Chem Toxicol* 50(9):2955-2963.
- Qazi MR, Xia Z, Bogdanska J, et al. 2009b. The atrophy and changes in the cellular compositions of the thymus and spleen observed in mice subjected to short-term exposure to perfluorooctanesulfonate are high-dose phenomena mediated in part by peroxisome proliferator-activated receptor-alpha (PPAR α). *Toxicology* 260(1-3):68-76.
- Qin XD, Qian Z, Vaughn MG, et al. 2016. Positive associations of serum perfluoroalkyl substances with uric acid and hyperuricemia in children from Taiwan. *Environ Pollut* 212:519-524. 10.1016/j.envpol.2016.02.050.
- Quaak I, de Cock M, de Boer M, et al. 2016. Prenatal exposure to perfluoroalkyl substances and behavioral development in children. *Int J Environ Res Public Health* 13(5). 10.3390/ijerph13050511.
- Quinete N, Wu Q, Zhang T, et al. 2009. Specific profiles of perfluorinated compounds in surface and drinking waters and accumulation in mussels, fish, and dolphins from southeastern Brazil. *Chemosphere* 77(6):863-869. 10.1016/j.chemosphere.2009.07.079.
- Quinones O, Snyder SA. 2009. Occurrence of perfluoroalkyl carboxylates and sulfonates in drinking water utilities and related waters from the United States. *Environ Sci Technol* 43(24):9089-9095.
- Quist EM, Filgo AJ, Cummings CA, et al. 2015a. Hepatic mitochondrial alteration in CD-1 mice associated with prenatal exposures to low doses of perfluorooctanoic acid (PFOA). *Toxicol Pathol* 43(4):546-557. 10.1177/0192623314551841.
- Quist EM, Filgo AJ, Cummings CA, et al. 2015b. Supplemental data: Hepatic mitochondrial alteration in CD-1 mice associated with prenatal exposures to low doses of perfluorooctanoic acid (PFOA). (*Toxicol Pathol* 43(4):546-557). *Toxicol Pathol* 43:546-557.
- Raleigh KK, Alexander BH, Olsen GW, et al. 2014. Mortality and cancer incidence in ammonium perfluorooctanoate production workers. *Occup Environ Med* 71(7):500-506. 10.1136/oemed-2014-102109.
- Rankin K, Lee H, Tseng PJ, et al. 2014. Investigating the biodegradability of a fluorotelomer-based acrylate polymer in a soil-plant microcosm by indirect and direct analysis. *Environ Sci Technol* 48(21):12783-12790.
- Raymer JH, Michael LC, Studabaker WB, et al. 2012. Concentrations of perfluorooctane sulfonate (PFOS) and perfluorooctanoate (PFOA) and their associations with human semen quality measurements. *Reprod Toxicol* 33(4):419-427.
- +Rebholz SL, Jones T, Herrick RL, et al. 2016. Hypercholesterolemia with consumption of PFOA-laced Western diets is dependent on strain and sex of mice. *Toxicology reports* 3:46-54. 10.1016/j.toxrep.2015.11.004.
- Reiner JL, Nakayama SF, Delinsky AD, et al. 2009. Analysis of PFOA in dosed CD1 mice. Part 1. Methods development for the analysis of tissues and fluids from pregnant and lactating mice and their pups. *Reprod Toxicol* 27(3-4):360-364. 10.1016/j.reprotox.2008.10.006.
- Ren H, Vallanat B, Nelson DM, et al. 2009. Evidence for the involvement of xenobiotic-responsive nuclear receptors in transcriptional effects upon perfluoroalkyl acid exposure in diverse species. *Reprod Toxicol* 27(3-4):266-277. 10.1016/j.reprotox.2008.12.011.
- RePORTER. 2017. Perfluoroalkyls. National Institutes of Health, Research Portfolio Online Reporting Tools. <http://projectreporter.nih.gov/reporter.cfm>. February 28, 2017.

8. REFERENCES

- Ribes D, Fuentes S, Torrente M, et al. 2010. Combined effects of perfluorooctane sulfonate (PFOS) and maternal restraint stress on hypothalamus adrenal axis (HPA) function in the offspring of mice. *Toxicol Appl Pharmacol* 243(1):13-18.
- Robledo CA, Yeung E, Mendola P, et al. 2015a. Preconception maternal and paternal exposure to persistent organic pollutants and birth size: The LIFE study. *Environ Health Perspect* 123(1):88-94. 10.1289/ehp.1308016.
- Robledo CA, Yeung E, Mendola P, et al. 2015b. Supplemental material to preconception maternal and paternal exposure to persistent organic pollutants and birth size: The LIFE study. [*Environ Health Perspect* 123(1):88-94]. *Environ Health Perspect* 10.1289/ehp.1308016.
- Rockwell CE, Turley AE, Cheng X, et al. 2013. Acute immunotoxic effects of perfluorononanoic acid (PFNA) in C57BL/6 Mice. *Clin Exp Pharmacol Suppl* 4. 10.4172/2161-1459.S4-002. <http://www.ncbi.nlm.nih.gov/pubmed/25568816>.
- Rockwell CE, Turley AE, Cheng X, et al. 2017. Persistent alterations in immune cell populations and function from a single dose of perfluorononanoic acid (PFNA) in C57B1/6 mice. *Food Chem Toxicol* 100:24-33.
- Rodriguez CE, Setzer RW, Barton HA. 2009. Pharmacokinetic modeling of perfluorooctanoic acid during gestation and lactation in the mouse. *Reprod Toxicol* 27(3-4):373-386.
- +Rogers JM, Ellis-Hutchings RG, Grey BE, et al. 2014. Elevated blood pressure in offspring of rats exposed to diverse chemicals during pregnancy. *Toxicol Sci* 137(2):436-446. 10.1093/toxsci/kft248.
- Romano ME, Xu Y, Calafat AM, et al. 2016. Maternal serum perfluoroalkyl substances during pregnancy and duration of breastfeeding. *Environ Res* 10.1016/j.envres.2016.04.034.
- Rosen MB, Abbott BD, Wolf DC, et al. 2008a. Gene profiling in the livers of wild-type and PPAR α -null mice exposed to perfluorooctanoic acid. *Toxicol Pathol* 36(4):592-607.
- Rosen MB, Das KP, Rooney J, et al. 2017. PPAR α -independent transcriptional targets of perfluoroalkyl acids revealed by transcript profiling. *Toxicology* [In press].
- Rosen MB, Lee JS, Ren H, et al. 2008b. Toxicogenomic dissection of the perfluorooctanoic acid transcript profile in mouse liver: Evidence for the involvement of nuclear receptors PPAR α and CAR. *Toxicol Sci* 103(1):46-56.
- Rosen MB, Schmid JR, Corton JC, et al. 2010. Gene expression profiling in wild-type and pparalpha-null mice exposed to perfluorooctane sulfonate reveals PPAR α -independent effects. *PPAR Res* 10.1155/2010/794739.
- +Rosen MB, Schmid JE, Das KP, et al. 2009. Gene expression profiling in the liver and lung of perfluorooctane sulfonate-exposed mouse fetuses: Comparison to changes induced by exposure to perfluorooctanoic acid. *Reprod Toxicol* 27:278-288.
- Rosen MB, Thibodeaux JR, Wood CR, et al. 2007. Gene expression profiling in the lung and liver of PFOA-exposed mouse fetuses. *Toxicology* 239:15-33.
- Rotander A, Toms LM, Aylward L, et al. 2015. Elevated levels of PFOS and PFHxS in firefighters exposed to aqueous film forming foam (AFFF). *Environ Int* 82:28-34. 10.1016/j.envint.2015.05.005.
- RTECS. 2008. Perfluoroalkyls. Hamilton, Ontario: Registry of Toxic Effects on Chemical Substances. Canadian Centre for Occupational Health and Safety. Symyx Software, Inc. May 29, 2008.
- Rumsby PC, McLaughlin CL, Hall T. 2009. Perfluorooctane sulphonate and perfluorooctanoic acid in drinking and environmental waters. *Philos Trans A Math Phys Eng Sci* 367(1904):4119-4136. 10.1098/rsta.2009.0109.
- Ryu MH, Jha A, Ojo OO, et al. 2014. Chronic exposure to perfluorinated compounds: Impact on airway hyperresponsiveness and inflammation. *Am J Physiol Lung Cell Mol Physiol* 307(10):L765-L774.
- Sakr CJ, Kreckmann KH, Green JW, et al. 2007b. Cross-sectional study of lipids and liver enzymes related to a serum biomarker of exposure (ammonium perfluorooctanoate or APFO) as part of a general health survey in a cohort of occupationally exposed workers. *J Occup Environ Med* 49:1086-1096.

8. REFERENCES

- Sakr CJ, Leonard RC, Kreckmann KH, et al. 2007a. Longitudinal study of serum lipids and liver enzymes in workers with occupational exposure to ammonium perfluorooctanoate. *J Occup Environ Med* 49:872-879.
- Sakr CJ, Symons JM, Kreckmann KH, et al. 2009. Ischaemic heart disease mortality study among workers with occupational exposure to ammonium perfluorooctanoate. *Occup Environ Med* 66:699-703.
- +Salgado R, Pereiro N, Lopez-Doval S, et al. 2015. Initial study on the possible mechanisms involved in the effects of high doses of perfluorooctane sulfonate (PFOS) on prolactin secretion. *Food Chem Toxicol* 83:10-16. 10.1016/j.fct.2015.05.013.
- Salvalaglio M, Muscionico I, Cavallotti C. 2010. Determination of energies and sites of binding of PFOA and PFOS to human serum albumin. *J Phys Chem B* 114(46):14860-14874.
- Sato I, Kawamoto K, Nishikawa Y, et al. 2009. Neurotoxicity of perfluorooctane sulfonate (PFOS) in rats and mice after single oral exposure. *J Toxicol Sci* 34(5):569-574.
- Savitz DA, Stein CR, Bartell SM, et al. 2012a. Perfluorooctanoic acid exposure and pregnancy outcome in a highly exposed community. *Epidemiology* 23(3):386-392.
- Savitz DA, Stein CR, Elston B, et al. 2012b. Relationship of perfluorooctanoic acid exposure to pregnancy outcome based on birth records in the Mid-Ohio Valley. *Environ Health Perspect* 120(8):1201-1207.
- Savu PM. 1994a. Fluorinated higher carboxylic acids. In: Kirk-Othmer encyclopedia of chemical technology. John Wiley & Sons, Inc., 1-7.
<http://mrw.interscience.wiley.com/emrw/9780471238966/kirk/article/fluosavu.a01/current/pdf>. April 01, 2008.
- Savu P. 1994b. Fluorine-containing polymers, perfluoroalkanesulfonic acids. In: Kirk-Othmer encyclopedia of chemical technology. John Wiley & Sons, Inc., 1-7.
<http://mrw.interscience.wiley.com/emrw/9780471238966/kirk/article/perfsavu.a01.current/pdf>. April 01, 2008.
- Schaidler LA, Balan SA, Blum A, et al. 2017. Fluorinated compounds in U.S. fast food packaging. *Environ Sci Tech Lett* 4(3):105-111. 10.1021/acs.estlett.6b00435.
- Schechter A, Colacino J, Haffner D, et al. 2010. Perfluorinated compounds, polychlorinated biphenyls, and organochlorine pesticide contamination in composite food samples from Dallas, Texas, USA. *Environ Health Perspect* 118(6):796-802.
- Schultz MM, Barofsky DF, Field JA. 2003. Fluorinated alkyl surfactants. *Environ Eng Sci* 20(5):487-501.
- Schultz MM, Barofsky DF, Field JA. 2006a. Quantitative determination of fluorinated alkyl substances by large-volume-injection liquid chromatography tandem mass spectrometry. Characterization of municipal wastewaters. *Environ Sci Technol* 40:289-295.
- Schultz MM, Higgins CP, Huset CA, et al. 2006b. Fluorochemical mass flows in a municipal wastewater treatment facility. *Environ Sci Technol* 40(23):7350-7367.
- +Seacat AM, Luebker DJ. 2000. Toxicokinetic study of perfluorooctane sulfonamide (PFOS; T-7132.2) in rats. 3M Strategic Toxicology Laboratory. Submitted to the U.S. Environmental Protection Agency's Administrative Record. AR226-1030A011.
- +Seacat AM, Thomford PJ, Hansen KJ, et al. 2002. Subchronic toxicity studies on perfluorooctanesulfonate potassium salt in Cynomolgus monkeys. *Toxicol Sci* 68(1):249-264.
- +Seacat AM, Thomford PJ, Hansen KJ, et al. 2003. Sub-chronic dietary toxicity of potassium perfluorooctanesulfonate in rats. (Erratum in: *Toxicology* 2003 192(2-3):263-264). *Toxicology* 183(1-3):117-133.
- Seals R, Bartell SM, Steenland K. 2011. Accumulation and clearance of perfluorooctanoic acid (PFOA) in current and former residents of an exposed community. *Environ Health Perspect* 119(1):119-124.
- Sepulvado JG, Blaine AC, Hundal LS, et al. 2011. Occurrence and fate of perfluorochemicals in soil following the land application of municipal biosolids. *Environ Sci Technol* 45(19):8106-8112. 10.1021/es103903d.

8. REFERENCES

- Shankar A, Xiao J, Ducatman A. 2011a. Perfluoroalkyl chemicals and chronic kidney disease in US adults. *Am J Epidemiol* 174(8):893-900.
- Shankar A, Xiao J, Ducatman A. 2011b. Perfluoroalkyl chemicals and elevated serum uric acid in US adults. *Clin Epidemiol* 3:251-258.
- Shankar A, Xiao J, Ducatman A. 2012. Perfluorooctanoic acid and cardiovascular disease in US adults. *Arch Intern Med* 172(18):1397-1403.
- Shapiro GD, Dodds L, Arbuckle TE, et al. 2016. Exposure to organophosphorus and organochlorine pesticides, perfluoroalkyl substances, and polychlorinated biphenyls in pregnancy and the association with impaired glucose tolerance and gestational diabetes mellitus: The MIREC Study. *Environ Res* 147:71-81. 10.1016/j.envres.2016.01.040.
- +Shi Z, Zhang H, Ding L, et al. 2009. The effect of perfluorododecanoic acid on endocrine status, sex hormones and expression of steroidogenic genes in pubertal female rats. *Reprod Toxicol* 27(3-4):352-359.
- +Shi Z, Zhang H, Liu Y, et al. 2007. Alterations in gene expression and testosterone synthesis in the testes of male rats exposed to perfluorododecanoic acid. *Toxicol Sci* 98(1):206-215.
- Shin HM, Vieira VM, Ryan PB, et al. 2011. Environmental fate and transport modeling for perfluorooctanoic acid emitted from the Washington Works Facility in West Virginia. *Environ Sci Technol* 45(4):1435-1442.
- Shiple JM, Hurst CH, Tanaka SS, et al. 2004. *trans*-Activation of PPAR(beta) and induction of PPAR(beta) target genes by perfluorooctane-based chemicals. *Toxicol Sci* 80(1):151-160.
- Shoeib M, Harner T, Ikononou M, et al. 2004. Indoor and outdoor air concentrations and phase partitioning of perfluoroalkyl sulfonamides and polybrominated diphenyl ethers. *Environ Sci Technol* 38:1313-1320.
- Shoeib M, Harner T, Vlahos P. 2006. Perfluorinated chemicals in the arctic atmosphere. *Environ Sci Technol* 40:7577-7583.
- Shrestha S, Bloom MS, Yucel R, et al. 2015. Perfluoroalkyl substances and thyroid function in older adults. *Environ Int* 75:206-214. 10.1016/j.envint.2014.11.018.
- Siegemund G, Schwertfeger W, Feiring A, et al. 2005. Fluorine compounds, organic. *Ullmann's Encyclopedia of Industrial Chemistry*. Wiley-VCH Verlag GmbH & Co. http://mrw.interscience.wiley.com/emrw/9783527306732/ueic/article/a11_349/current/abstract. April 01, 2008.
- Simcik MF. 2005. Global transport and fate of perfluorochemicals. *J Environ Monit* 7:759-763.
- Simcik MF, Dorweiler KJ. 2005. Ratio of perfluorochemical concentrations as a tracer of atmospheric deposition to surface waters. *Environ Sci Technol* 39:8678-8683.
- Simpson C, Winquist A, Lally C, et al. 2013. Relation between perfluorooctanoic acid exposure and strokes in a large cohort living near a chemical plant. *Environ Res* 127:22-28. 10.1016/j.envres.2013.10.002.
- Sinclair E, Kannan K. 2006. Mass loading and fate of perfluoroalkyl surfactants in wastewater treatment plants. *Environ Sci Technol* 40(5):1408-1414.
- Sinclair E, Kim SK, Akinleye HB, et al. 2007. Quantitation of gas-phase perfluoroalkyl surfactants and fluorotelomer alcohols released from nonstick cookware and microwave popcorn bags. *Environ Sci Technol* 41:1180-1185.
- Sinclair E, Mayack DT, Roblee K, et al. 2006. Occurrence of perfluoroalkyl surfactants in water, fish, and birds from New York State. *Arch Environ Contam Toxicol* 50:398-401.
- Sinclair E, Taniyasu S, Yamashita N, et al. 2004. Perfluorooctanoic acid and perfluorooctane sulfonate in Michigan and New York waters. *Organohalogen Compounds* 66:4069-4073.
- Skuladottir M, Ramel A, Rytter D, et al. 2015. Examining confounding by diet in the association between perfluoroalkyl acids and serum cholesterol in pregnancy. *Environ Res* 143(Pt A):33-38. 10.1016/j.envres.2015.09.001.

8. REFERENCES

- Small MJ. 2009. Final report of the peer consultation panel conducting the review for the scientific peer consultation process for a site environmental assessment program as part of the Dupont-EPA memorandum of understanding and Phase II Workplan. Pittsburgh, PA: Carnegie Mellon University, Civil and Environmental Engineering and Engineering and Public Policy.
- Smit LA, Lenters V, Hoyer BB, et al. 2015. Prenatal exposure to environmental chemical contaminants and asthma and eczema in school-age children. *Allergy* 70(6):653-660. 10.1111/all.12605.
- Smithwick M, Mabury SA, Solomon KR, et al. 2005a. Circumpolar study of perfluoroalkyl contaminants in polar bears (*Ursus maritimus*). *Environ Sci Technol* 39(15):5517-5523.
- Smithwick M, Muir DC, Mabury SA, et al. 2005b. Perfluoroalkyl contaminants in liver tissue from East Greenland polar bears (*Ursus maritimus*). *Environ Toxicol Chem* 24(4):981-986.
- Smithwick M, Norstrom RJ, Mabury SA, et al. 2006. Temporal trends of perfluoroalkyl contaminants in polar bears (*Ursus maritimus*) from two locations in the North American arctic, 1972-2002. *Environ Sci Technol* 40:1139-1143.
- So MK, Taniyasu S, Lam PKS, et al. 2006a. Alkaline digestion and solid phase extraction method for perfluorinated compounds in mussels and oysters from South China and Japan. *Arch Environ Contam Toxicol* 50:240-248.
- So MK, Yamashita N, Taniyasu S, et al. 2006b. Health risks in infants associated with exposure to perfluorinated compounds in human breast milk from Zhoushan, China. *Environ Sci Technol* 40:2924-2929.
- +Sobolewski M, Conrad K, Allen JL, et al. 2014. Sex-specific enhanced behavioral toxicity induced by maternal exposure to a mixture of low dose endocrine-disrupting chemicals. *Neurotoxicology* 45:121-130. 10.1016/j.neuro.2014.09.008.
- +Son H, Kim S, Shin HI, et al. 2008. Perfluorooctanoic acid-induced hepatic toxicity following 21-day oral exposure in mice. *Arch Toxicol* 82:239-246.
- +Son HY, Lee S, Tak EN, et al. 2009. Perfluorooctanoic acid alters T lymphocyte phenotypes and cytokine expression in mice. *Environ Toxicol* 24(6):580-588.
- SPARC. 2008. Macroscopic pka. Sparc Performs Automated Reasoning in Chemistry. <http://sparc.chem.ugs.edu/sparc/display/ShowMacro.cfm>. May 08, 2008.
- Specht IO, Hougaard KS, Spano D, et al. 2012. Sperm DNA integrity in relation to exposure to environmental perfluoroalkyl substances. A study of spouses of pregnant women in three geographical regions. *Reprod Toxicol* 33:577-583.
- Splithoff HM, Tao L, Shaver SM, et al. 2008. Use of newborn screening program blood spots for exposure assessment: Declining levels of perfluorinated compounds in New York State infants. *Environ Sci Technol* 42(14):5361-5367.
- Staels B, Dallongeville J, Auwerx J, et al. 1998. Mechanism of action of fibrates on lipid and lipoprotein metabolism. *Circulation* 98:2088-2093.
- +Staples RE, Burgess BA, Kerns WD. 1984. The embryo-fetal toxicity and teratogenic potential of ammonium perfluorooctanoate (APFO) in the rat. *Fundam Appl Toxicol* 4:429-440.
- Starkov AA, Wallace KB. 2002. Structural determinants of fluorochemical-induced mitochondrial dysfunction. *Toxicol Sci* 66(2):244-252.
- Starling AP, Engel SM, Richardson DB, et al. 2014b. Perfluoroalkyl substances during pregnancy and validated preeclampsia among nulliparous women in the Norwegian Mother and Child Cohort Study. *Am J Epidemiol* 179(7):824-833. 10.1093/aje/kwt432.
- Starling AP, Engel SM, Whitworth KW, et al. 2014a. Perfluoroalkyl substances and lipid concentrations in plasma during pregnancy among women in the Norwegian Mother and Child Cohort Study. *Environ Int* 62:104-112. 10.1016/j.envint.2013.10.004.
- Stasinakis AS, Petalas AV, Mamais D, et al. 2008. Application of the OECD 301F respirometric test for the biodegradability assessment of various potential endocrine disrupting chemicals. *Bioresour Technol* 99:3458-3467.
- Steenland K, Woskie S. 2012. Cohort mortality study of workers exposed to perfluorooctanoic acid. *Am J Epidemiol* 176(10):909-917.

8. REFERENCES

- Steenland K, Fletcher T, Savitz DA. 2010a. Epidemiologic evidence on the health effects of perfluorooctanoic acid (PFOA). *Environ Health Perspect* 118(8):1100-1108.
- Steenland K, Jin C, MacNeil J, et al. 2009a. Predictors of PFOA levels in a community surrounding a chemical plant. *Environ Health Perspect* 117(7):1083-1088.
- Steenland K, Tinker S, Frisbee S, et al. 2009b. Association of perfluorooctanoic acid and perfluorooctane sulfonate with serum lipids among adults living near a chemical plant. *Am J Epidemiol* 170(10):1268-1278.
- Steenland K, Tinker S, Shankar A, et al. 2010b. Association of perfluorooctanoic acid (PFOA) and perfluorooctane sulfonate (PFOS) with uric acid among adults with elevated community exposure to PFOA. *Environ Health Perspect* 118(2):229-233.
- Steenland K, Zhao L, Winquist A, et al. 2013. Ulcerative colitis and perfluorooctanoic acid (PFOA) in a highly exposed population of community residents and workers in the Mid-Ohio Valley. *Environ Health Perspect* 121(8):900-905.
- Steenland K, Zhao L, Winquist A. 2015. A cohort incidence study of workers exposed to perfluorooctanoic acid (PFOA). *Occup Environ Med* 72(5):373-380. 10.1136/oemed-2014-102364.
- Stein CR, Savitz DA. 2011. Serum perfluorinated compound concentration and attention deficit/hyperactivity disorder in children 5-18 years of age. *Environ Health Perspect* 119(10):1466-1471.
- Stein CR, McGovern KJ, Pajak AM, et al. 2016a. Perfluoroalkyl and polyfluoroalkyl substances and indicators of immune function in children aged 12-19 y: National Health and Nutrition Examination Survey. *Pediatr Res* 79(2):348-357. 10.1038/pr.2015.213.
- Stein CR, Ge Y, Wolff MS, et al. 2016b. Perfluoroalkyl substance serum concentrations and immune response to FluMist vaccination among healthy adults. *Environ Res* 149:171-178. 10.1016/j.envres.2016.05.020.
- Stein CR, Savitz DA, Bellinger DC. 2013. Perfluorooctanoate and neuropsychological outcomes in children. *Epidemiology* 24(4):590-599.
- Stein CR, Savitz DA, Bellinger DC. 2014a. Perfluorooctanoate exposure in a highly exposed community and parent and teacher reports of behaviour in 6-12-year-old children. *Paediatr Perinat Epidemiol* 28(2):146-156. 10.1111/ppe.12097.
- Stein CR, Savitz DA, Bellinger DC. 2014b. Supporting information to perfluorooctanoate exposure in a highly exposed community and parent and teacher reports of behaviour in 6-12-year-old children. *Paediatr Perinat Epidemiol* 10.1111/ppe.12097.
- Stein CR, Savitz DA, Elston B, et al. 2014c. Perfluorooctanoate exposure and major birth defects. *Reprod Toxicol* 47:15-20. 10.1016/j.reprotox.2014.04.006.
- Stein CR, Savitz DA, Dougan M. 2009. Serum levels of perfluorooctanoic acid and perfluorooctane sulfonate and pregnancy outcome. *Am J Epidemiol* 170(7):837-846.
- Stock NL, Lau FK, Ellis DA, et al. 2004. Polyfluorinated telomer alcohols and sulfonamides in the North American troposphere. *Environ Sci Technol* 38:991-996.
- Strøm M, Hansen S, Olsen SF, et al. 2014. Persistent organic pollutants measured in maternal serum and offspring neurodevelopmental outcomes--a prospective study with long-term follow-up. *Environ Int* 68:41-48. 10.1016/j.envint.2014.03.002.
- Strynar MJ, Lindstrom AB. 2008. Perfluorinated compounds in house dust from Ohio and North Carolina, USA. *Environ Sci Technol* 42:3751-3756.
- Strynar MJ, Lindstrom AB, Nakayama SF, et al. 2012. Pilot scale application of a method for the analysis of perfluorinated compounds in surface soils. *Chemosphere* 86:252-257.
- Su TC, Kuo CC, Hwang JJ, et al. 2016. Serum perfluorinated chemicals, glucose homeostasis and the risk of diabetes in working-aged Taiwanese adults. *Environ Int* 88:15-22. 10.1016/j.envint.2015.11.016.
- Suh CH, Cho NK, Lee CK, et al. 2011. Perfluorooctanoic acid-induced inhibition of placental prolactin-family hormone and fetal growth retardation in mice. *Mol Cell Endocrinol* 337(1-2):7-15.

8. REFERENCES

- Sundström M, Chang SC, Noker PE, et al. 2012. Comparative pharmacokinetics of perfluorohexanesulfonate (PFHxS) in rats, mice, and monkeys. *Reprod Toxicol* 33(4):441-451.
- Sweeney LM, Tyler TR, Kirman CR, et al. 2001. Proposed occupational exposure limits for select ethylene glycol ethers using PBPK models and Monte Carlo simulations. *Toxicol Sci* 62(1):124-139.
- Takacs ML, Abbott BD. 2007. Activation of mouse and human peroxisome proliferator-activated receptors (α, β, γ) by perfluorooctanoic acid and perfluorooctane sulfonate. *Toxicol Sci* 95(1):108-117.
- Takagi A, Sai K, Umemura T, et al. 1991. Short-term exposure to the peroxisome proliferators, perfluorooctanoic acid and perfluorodecanoic acid, causes significant increase of 8-hydroxydeoxyguanosine in liver DNA of rats. *Cancer Lett* 57(1):55-60.
- +Takahashi M, Ishida S, Hirata-Koizumi M, et al. 2014. Repeated dose and reproductive/developmental toxicity of perfluoroundecanoic acid in rats. *J Toxicol Sci* 39(1):97-108.
- +Tan X, Xie G, Sun X, et al. 2013. High fat diet feeding exaggerates perfluorooctanoic acid-induced liver injury in mice via modulating multiple metabolic pathways. *PLoS ONE* 8(4):e61409.
- Tan Y, Clewell HJ, Andersen ME. 2008. Time dependencies in perfluorooctylacids disposition in rat and monkeys: A kinetic analysis. *Toxicol Lett* 177:38-47.
- Tatum-Gibbs K, Wambaugh JF, Das KP, et al. 2011. Comparative pharmacokinetics of perfluorononanoic acid in rat and mouse. *Toxicology* 281(1-3):48-55. 10.1016/j.tox.2011.01.003.
- Tao L, Kannan K, Aldous KM, et al. 2008a. Biomonitoring of perfluorochemicals in plasma of New York State personnel responding to the World Trade Center disaster. *Environ Sci Technol* 42(9):3472-3478.
- Tao L, Kannan K, Wong CM, et al. 2008b. Perfluorinated compounds in human milk from Massachusetts, U.S.A. *Environ Sci Technol* 42(8):3096-3101.
- Tarazona JV, Rodriguez C, Alonso E, et al. 2016. Toxicokinetics of perfluorooctane sulfonate in rabbits under environmentally realistic exposure conditions and comparative assessment between mammals and birds. *Toxicol Lett* 241:200-206. 10.1016/j.toxlet.2015.11.002.
- Tardiff RG, Carson ML, Sweeney LM, et al. 2009. Derivation of a drinking water equivalent level (DWEL) related to the maximum contaminant level goal for perfluorooctanoic acid (PFOA), a persistent water soluble compound. *Food Chem Toxicol* 47(10):2557-2589.
- Taylor KW, Hoffman K, Thayer KA, et al. 2014. Polyfluoroalkyl chemicals and menopause among women 20-65 years of age (NHANES). *Environ Health Perspect* 122(2):145-150. 10.1289/ehp.1306707.
- +Thibodeaux JR, Hanson RG, Rogers JM, et al. 2003. Exposure to perfluorooctane sulfonate during pregnancy in rat and mouse. I: Maternal and prenatal evaluations. *Toxicol Sci* 74(2):369-381.
- +Thomford PJ. 2001. 4-Week capsule toxicity study with ammonium perfluorooctanoate (APFO) in Cynomolgus monkeys. APME Ad-Hoc APFO toxicology working group.
- +Thomford PJ. 2002a. 4-week capsule toxicity study with perfluorooctane sulfonic acid potassium salt (PFOS; T-6295) in Cynomolgus monkeys. St. Paul, MN: 3M.
- +Thomford PJ. 2002b. 104-Week dietary chronic toxicity and carcinogenicity study with perfluorooctane sulfonic acid potassium salt (PFOS; T-6295) in rats. St. Paul, MN: 3M.
- Thompson J, Lorber M, Toms LM, et al. 2010. Use of simple pharmacokinetic modeling to characterize exposure of Australians to perfluorooctanoic acid and perfluorooctane sulfonic acid. *Environ Int* 36(4):390-397. 10.1016/j.envint.2010.02.008.
- Thomsen C, Haug LS, Stigum H, et al. 2010. Changes in concentrations of perfluorinated compounds, polybrominated diphenyl ethers, and polychlorinated biphenyls in Norwegian breast-milk during twelve months of lactation. *Environ Sci Technol* 44(24):9550-9556.
- Timmermann CA, Rossing LI, Grontved A, et al. 2014. Adiposity and glycemic control in children exposed to perfluorinated compounds. *J Clin Endocrinol Metab* 99(4):E608-614. 10.1210/jc.2013-3460.

8. REFERENCES

- Tittlemier S, Ryan JJ, Van Oostdam J. 2004. Presence of anionic perfluorinated organic compounds in serum collected from northern Canadian populations. *Organohalogen Compounds* 66:3959-3964.
- Tittlemier SA, Pepper K, Seymour C, et al. 2007. Dietary exposure of Canadians to perfluorinated carboxylates and perfluorooctane sulfonate via consumption of meat, fish, fast foods, and food items prepared in their packaging. *J Agric Food Chem* 55:3203-3210.
- Toft G, Jonsson BA, Bonde JP, et al. 2016. Perfluorooctane sulfonate concentrations in amniotic fluid, biomarkers of fetal Leydig Cell Function, and cryptorchidism and hypospadias in Danish boys (1980-1996). *Environ Health Perspect* 124(1):151-156. 10.1289/ehp.1409288.
- Toft G, Jonsson BA, Lindh CH, et al. 2012. Exposure to perfluorinated compounds and human semen quality in Arctic and European populations. *Hum Reprod* 27(8):2532-2540.
- Toms LL, Calafat AM, Kato K, et al. 2009. Polyfluoroalkyl chemicals in pooled blood serum from infants, children, and adults in Australia. *Environ Sci Technol* 43(11):4194-4199.
- Tomy GT, Budakowski W, Halldorson T, et al. 2004. Fluorinated organic compounds in an eastern arctic marine food web. *Environ Sci Technol* 38:6475-6481.
- Trudel D, Horowitz L, Wormuth M, et al. 2008. Estimating consumer exposure to PFOS and PFOA. *Risk Anal* 28(2):251-269.
- Tsai MS, Lin CY, Lin CC, et al. 2015. Association between perfluoroalkyl substances and reproductive hormones in adolescents and young adults. *Int J Hyg Environ Health* 218(5):437-443. 10.1016/j.ijheh.2015.03.008.
- +Tucker DK, Macon MB, Strynar MJ, et al. 2015. The mammary gland is a sensitive pubertal target in CD-1 and C57Bl/6 mice following perinatal perfluorooctanoic acid (PFOA) exposure. *Reprod Toxicol* 54:26-36. 10.1016/j.reprotox.2014.12.002.
- Uhl SA, James-Todd T, Bell ML. 2013. Association of osteoarthritis with perfluorooctanoate and perfluorooctane sulfonate in NHANES 2003-2008. *Environ Health Perspect* 121(4):447-452.
- Upham BL, Deocampo ND, Wurl B, et al. 1998. Inhibition of gap junctional intercellular communication by perfluorinated fatty acids is dependent on the chain length of the fluorinated tail. *Int J Cancer* 78:491-495.
- Upham BL, Park JS, Babica P, et al. 2009. Structure-activity-dependent regulation of cell communication by perfluorinated fatty acids using *in vivo* and *in vitro* model systems. *Environ Health Perspect* 117(4):545-551. 10.1289/ehp.11728.
- URS. 2012. MOU Phase III - future work plan data assessment DuPont Washington Works, Washington, West Virginia, PFOA site-related environmental assessment program (OPPT-2004-0113 PFOA). In: Docket EPA-HQ-2004-0113-0517. Supporting documents: Letter to Dr. Maria Doa, Director, Chemical Control Division, USEPA, from Andrew S. Hartten, Principal Remediation Project Manager, DuPont Corporate Remediation Group. URS Corporation. <https://www.regulations.gov/document?D=EPA-HQ-OPPT-2004-0113-0516> February 28, 2017.
- Vagi SJ, Azziz-Baumgartner E, Sjodin A, et al. 2014. Exploring the potential association between brominated diphenyl ethers, polychlorinated biphenyls, organochlorine pesticides, perfluorinated compounds, phthalates, and bisphenol A in polycystic ovary syndrome: A case-control study. *BMC Endoc Disord* 14:86. 10.1186/1472-6823-14-86.
- Vanden Heuvel JP, Davis JW, Sommers R, et al. 1992a. Renal excretion of perfluorooctanoic acid in male rats: Inhibitory effect of testosterone. *J Biochem Toxicol* 7(1):31-36.
- Vanden Heuvel JP, Kuslikis BI, Peterson RE. 1992b. Covalent binding of perfluorinated fatty acids to proteins in the plasma, liver and testes of rats. *Chem Biol Interact* 82:318-328.
- Vanden Heuvel JP, Kuslikis BI, Shrago E, et al. 1991a. Inhibition of long-chain acyl-CoA synthetase by the peroxisome proliferator perfluorodecanoic acid in rat hepatocytes. *Biochem Pharmacol* 42(2):295-302.
- Vanden Heuvel JP, Kuslikis BI, Van Rafelghem MJ, et al. 1991b. Disposition of perfluorodecanoic acid in male and female rats. *Toxicol Appl Pharmacol* 107:450-459.
- Vanden Heuvel JP, Kuslikis BI, Van Rafelghem MJ, et al. 1991c. Tissue distribution, metabolism, and elimination of perfluorooctanoic acid in male and female rats. *J Biochem Toxicol* 6(2):83-92.

8. REFERENCES

- Vanden Heuvel JP, Thompson JT, Frame SR, et al. 2006. Differential activation of nuclear receptors by perfluorinated fatty acid analogs and natural fatty acids: A comparison of human, mouse, and rat peroxisome proliferator-activated receptor- α , - β , and - γ , liver x receptor- β , and retinoid x receptor- α . *Toxicol Sci* 92(2):476-489.
- +van Otterdijk FM. 2007a. Repeated dose 28-day oral toxicity study with MTDID-8391 by daily gavage in the rat, followed by a 21-day recovery period. 3M.
- van Otterdijk FM. 2007b. Repeated dose 90-day oral toxicity study with MTDID 8391 by daily gavage in the rat followed by a 3-week recovery period. 3M.
- Vélez MP, Arbuckle TE, Fraser WD. 2015. Maternal exposure to perfluorinated chemicals and reduced fecundity: The MIREC study. *Hum Reprod* 30(3):701-709. 10.1093/humrep/deu350.
- Vermont Department of Health. 2017. Drinking water guidance. Burlington, VT: Vermont Department of Health.
http://www.healthvermont.gov/sites/default/files/documents/pdf/ENV_DW_Guidance.pdf.
December 19, 2017.
- Verner MA, Loccisano AE, Morken NH, et al. 2015. Associations of perfluoroalkyl substances (PFAS) with lower birth weight: An evaluation of potential confounding by glomerular filtration rate using a physiologically based pharmacokinetic model (PBPK). *Environ Health Perspect* 123(12):1317-1324.
- Verner MA, Longnecker MP. 2015. Comment on "Enhanced elimination of perfluorooctanesulfonic acid by menstruating women: Evidence from population-based pharmacokinetic modeling." *Environ Sci Technol* 49(9):5836-5837. 10.1021/acs.est.5b00187.
- Verner MA, Ngueta G, Jensen ET, et al. 2016. A simple pharmacokinetic model of prenatal and postnatal exposure to perfluoroalkyl substances (PFASs). *Environ Sci Technol* 50(2):978-986.
- Verreault J, Berger U, Gabrielsen GW. 2007. Trends of perfluorinated alkyl substances in herring gull eggs from two coastal colonies in northern Norway: 1983-2003. *Environ Sci Technol* 41:6671-6677.
- Verreault J, Houde M, Gabrielsen GW, et al. 2005. Perfluorinated alkyl substances in plasma, liver, brain, and eggs of glaucous gulls (*Larus hyperboreus*) from the Norwegian Arctic. *Environ Sci Technol* 39:7439-7445.
- Vested A, Ramlau-Hansen CH, Olsen SF, et al. 2013. Associations of *in utero* exposure to perfluorinated alkyl acids with human semen quality and reproductive hormones in adult men. *Environ Health Perspect* 121(4):453-458.
- Vestergaard S, Nielsen F, Andersson AM, et al. 2012. Association between perfluorinated compounds and time to pregnancy in a prospective cohort of Danish couples attempting to conceive. *Hum Reprod* 27(3):873-880.
- Vestergren R, Cousins IT. 2009. Tracking the pathways of human exposure to perfluorocarboxylates. *Environ Sci Technol* 43(15):5565-5575.
- Vestergren R, Cousins IT, Trudel D, et al. 2008. Estimating the contribution of precursor compounds in consumer exposure to PFOS and PFOA. *Chemosphere* 73(10):1617-1624.
- Vesterholm Jensen D, Christensen J, Virtanen HE, et al. 2014. No association between exposure to perfluorinated compounds and congenital cryptorchidism: A nested case-control study among 215 boys from Denmark and Finland. *Reproduction* 147(4):411-417.
- +Vetvicka V, Vetvickova J. 2013. Reversal of perfluorooctanesulfonate-induced immunotoxicity by a glucan-resveratrol-vitamin C combination. *Oriental Pharmacy and Experimental Medicine* 13(1):77-84.
- +Viberg H, Lee I, Eriksson P. 2013. Adult dose-dependent behavioral and cognitive disturbances after a single neonatal PFHxS dose. *Toxicology* 304:185-191.
- Vieira VM, Hoffman K, Shin M, et al. 2013. Perfluorooctanoic acid exposure and cancer outcomes in a contaminated community: A geographic analysis. *Environ Health Perspect* 121(3):318-323.

8. REFERENCES

- Völkel W, Genzel-Boroviczeny O, Demmelmair H, et al. 2008. Perfluorooctane sulphonate (PFOS) and perfluorooctanoic acid (PFOA) in human breast milk: Results of a pilot study. *Int J Hyg Environ Health* 211:440-446.
- von Ehrenstein OS, Fenton SE, Kato K, et al. 2009. Polyfluoroalkyl chemicals in the serum and milk of breastfeeding women. *Reprod Toxicol* 27(3-4):239-245.
- Vuong AM, Yolton K, Webster GM, et al. 2016. Prenatal polybrominated diphenyl ether and perfluoroalkyl substance exposures and executive function in school-age children. *Environ Res* 147:556-564. 10.1016/j.envres.2016.01.008.
- Wallace K, Kissling G, Melnick R, et al. 2013. Structure-activity relationships for perfluoroalkane-induced *in vitro* interference with rat liver mitochondrial respiration. *Toxicol Lett* 222(3):257-264.
- Wallington TJ, Hurley MD, Xia J, et al. 2006. Formation of C₇F₁₅COOH (PFOA) and other perfluorocarboxylic acids during the atmospheric oxidation of 8:2 fluorotelomer alcohol. *Environ Sci Technol* 40:924-930.
- Walters M, Bjork J, Wallace K. 2009. Perfluorooctanoic acid stimulated mitochondrial biogenesis and gene transcription in rats. *Toxicology* 264(1):10-15.
- Wambaugh JF, Barton HA, Setzer RW. 2008. Comparing models for perfluorooctanoic acid pharmacokinetics using Bayesian analysis. *J Pharmacokinet Pharmacodyn* 35(6):683-712. 10.1007/s10928-008-9108-2.
- Wambaugh JF, Setzer RW, Pitruzzello AM, et al. 2013. Dosimetric anchoring of *in vivo* and *in vitro* studies for perfluorooctanoate and perfluorooctanesulfonate. *Toxicol Sci* 136(2):308-327. 10.1093/toxsci/kft204.
- Wan HT, Mruk DD, Wong CK, et al. 2014a. Perfluorooctanesulfonate (PFOS) perturbs male rat Sertoli cell blood-testis barrier function by affecting F-actin organization via p-FAK-Tyr(407): An *in vitro* study. *Endocrinology* 155(1):249-262. 10.1210/en.2013-1657.
- +Wan HT, Zhao YG, Wong MH, et al. 2011. Testicular signaling is the potential target of perfluorooctanesulfonate-mediated subfertility in male mice. *Biol Reprod* 84(5):1016-1023.
- +Wan HT, Zhao YG, Leung PY, et al. 2014b. Perinatal exposure to perfluorooctane sulfonate affects glucose metabolism in adult offspring. *PLoS ONE* 9(1):e87137. 10.1371/journal.pone.0087137.
- Wang JJ, Hsieh W-S, Chen C-Y, et al. 2011. The effect of prenatal perfluorinated chemicals exposures on pediatric atopy. *Environ Res* 111(6):785-791.
- Wang J, Zhang Y, Zhang W, et al. 2012. Association of perfluorooctanoic acid with HDL cholesterol and circulating miR-26b and miR-199-3p in workers of a fluorochemical plant and nearby residents. *Environ Sci Technol* 46(17):9274-9281.
- Wang J, Yan S, Zhang W, et al. 2015a. Integrated proteomic and miRNA transcriptional analysis reveals the hepatotoxicity mechanism of PFNA exposure in mice. *J Proteome Res* 14(1):330-341. 10.1021/pr500641b.
- Wang N, Szostek B, Buck RC, et al. 2005a. Fluorotelomer alcohol biodegradation—direct evidence that perfluorinated carbon chains breakdown. *Environ Sci Technol* 39:7516-7528.
- Wang N, Szostek B, Folsom PW, et al. 2005b. Aerobic biotransformation of 14c-labeled 8-2 telomer B alcohol by activated sludge from a domestic sewage treatment plant. *Environ Sci Technol* 39:531-538.
- Wang Y, Adgent M, Su PH, et al. 2016. Prenatal exposure to perfluorocarboxylic acids (PFCAs) and fetal and postnatal growth in the Taiwan maternal and infant cohort study. *Environ Health Perspect* 10.1289/ehp.1509998.
- Wang Y, Liu W, Zhang Q, et al. 2015c. Effects of developmental perfluorooctane sulfonate exposure on spatial learning and memory ability of rats and mechanism associated with synaptic plasticity. *Food Chem Toxicol* 76:70-76. 10.1016/j.fct.2014.12.008.
- Wang Y, Rogan WJ, Chen PC, et al. 2014. Association between maternal serum perfluoroalkyl substances during pregnancy and maternal and cord thyroid hormones: Taiwan maternal and infant cohort study. *Environ Health Perspect* 122(5):529-534. 10.1289/ehp.1306925.

8. REFERENCES

- Wang Y, Rogan WJ, Chen HY, et al. 2015b. Prenatal exposure to perfluoroalkyl substances and children's IQ: The Taiwan maternal and infant cohort study. *Int J Hyg Environ Health* 218(7):639-644. 10.1016/j.ijheh.2015.07.002.
- Wang Y, Starling AP, Haug LS, et al. 2013a. Association between perfluoroalkyl substances and thyroid stimulating hormone among pregnant women: A cross-sectional study. *Environ Health* 12(1):76. 10.1186/1476-069x-12-76.
- Wang Y, Yeung LWY, Taniyasu S, et al. 2008. Perfluorooctane sulfonate and other fluorochemicals in waterbird eggs from south China. *Environ Sci Technol* 42(21):8146-8151.
- Wang Z, Cousins IT, Scheringer M, et al. 2013b. Fluorinated alternatives to long-chain perfluoroalkyl carboxylic acids (PFCAs), perfluoroalkane, sulfonic acids (PFSAs) and their potential precursors. *Environ Int* 60:242-248.
- Wania F. 2007. A global mass balance analysis of the source of perfluorocarboxylic acids in the Arctic Ocean. *Environ Sci Technol* 41:4529-4535.
- Washburn ST, Bingman TS, Braitwaite SK, et al. 2005. Exposure assessment and risk characterization for perfluorooctanoate in selected consumer articles. *Environ Sci Technol* 39:3904-3910.
- Washington JW, Ellington J, Jenkins TM, et al. 2009. Degradability of an acrylate-linked, fluorotelomer polymer in soil. *Environ Sci Technol* 43(17):6617-6623.
- Washington JW, Jenkins TM. 2015. Abiotic hydrolysis of fluorotelomer-based polymers as a source of perfluorocarboxylates at the global scale. *Environ Sci Technol* 49(24):14129-14135. 10.1021/acs.est.5b03686.
- Washington JW, Jenkins TM, Rankin K, et al. 2015. Decades-scale degradation of commercial, side-chain, fluorotelomer-based polymers in soils and water. *Environ Sci Technol* 49(2):915-823.
- Washino N, Saijo Y, Sasaki S, et al. 2009. Correlations between prenatal exposure to perfluorinated chemicals and reduced fetal growth. *Environ Health Perspect* 117:660-667.
- Watkins DJ, Josson J, Elston B, et al. 2013. Exposure to perfluoroalkyl acids and markers of kidney function among children and adolescents living near a chemical plant. *Environ Health Perspect* 121(5):625-630.
- Weaver YM, Ehresman DJ, Butenhoff JL, et al. 2010. Roles of rat renal organic anion transporters in transporting perfluorinated carboxylates with different chain lengths. *Toxicol Sci* 113(2):305-314.
- Webster GM, Rauch SA, Marie NS, et al. 2016. Cross-sectional associations of serum perfluoroalkyl acids and thyroid hormones in U.S. adults: Variation according to TPOAb and iodine status (NHANES 2007-2008). *Environ Health Perspect* 124(7):935-942. 10.1289/ehp.1409589.
- Wei S, Chen LQ, Taniyasu S, et al. 2007a. Distribution of perfluorinated compounds in surface seawaters between Asia and Antarctica. *Mar Pollut Bull* 54:1813-1838.
- Wei Y, Dai J, Liu M, et al. 2007b. Estrogen-like properties of perfluorooctanoic acid as revealed by expressing hepatic estrogen-responsive genes in rare minnows (*Gobiocypris rarus*). *Environ Toxicol Chem* 26(11):2440-2447.
- Wen LL, Lin LY, Su TC, et al. 2013. Association between serum perfluorinated chemicals and thyroid function in U.S. adults: The national health and nutrition examination survey 2007-2010. *J Clin Endocrinol Metab* 98(9):E1456-1464. 10.1210/jc.2013-1282.
- +White SS, Calafat AM, Kuklenyik Z, et al. 2007. Gestational PFOA exposure of mice is associated with altered mammary gland development in dams and female offspring. *Toxicol Sci* 96(1):133-144.
- +White SS, Kato K, Jia LT, et al. 2009. Effects of perfluorooctanoic acid on mouse mammary gland development and differentiation resulting from cross-foster and restricted gestational exposures. *Reprod Toxicol* 27(3-4):289-298.
- +White SS, Stanko JP, Kato K, et al. 2011. Gestational and chronic low-dose PFOA exposures and mammary gland growth and differentiation in three generations of CD-1 mice. *Environ Health Perspect* 119(8):1070-1076.
- Whitworth KW, Haug LS, Baird DD, et al. 2012a. Perfluorinated compounds in relation to birth weight in the Norwegian Mother and Child Cohort Study. *Am J Epidemiol* 175(12):1209-1216.

8. REFERENCES

- Whitworth KW, Haug LS, Baird DD, et al. 2012b. Perfluorinated compounds and subfecundity in pregnant women. *Epidemiology* 23(2):257-263.
- WHO. 2010. Guidelines for indoor air quality: Selected pollutants. Geneva, Switzerland: World Health Organization. http://www.euro.who.int/__data/assets/pdf_file/0009/128169/e94535.pdf. January 08, 2014.
- WHO. 2017. Guidelines for drinking-water quality. Geneva, Switzerland: World Health Organization. <http://apps.who.int/iris/bitstream/10665/254637/1/9789241549950-eng.pdf?ua=1>. February 28, 2017.
- Wilhelm M, Kraft M, Rauchfuss K, et al. 2008. Assessment and management of the first German case of a contamination with perfluorinated compounds (PFC) in the Region Sauerland, North Rhine-Westphalia. *J Toxicol Environ Health A* 71:725-733.
- Wilhelm M, Holzer J, Dobler L, et al. 2009. Preliminary observations on perfluorinated compounds in plasma samples (1977-2004) of young German adults from an area with perfluorooctanoate-contaminated drinking water. *Int J Hyg Environ Health* 212(2):142-145.
- Winquist A, Steenland K. 2014a. Modeled PFOA exposure and coronary artery disease, hypertension, and high cholesterol in community and worker cohorts. *Environ Health Perspect* 122(12):1299-1305. 10.1289/ehp.1307943.
- Winquist A, Steenland K. 2014b. Perfluorooctanoic acid exposure and thyroid disease in community and worker cohorts. *Epidemiology* 25(2):255-264. 10.1097/ede.0000000000000040.
- +Wolf CJ, Fenton SE, Schmid JE, et al. 2007. Developmental toxicity of perfluorooctanoic acid in the CD-1 mouse after cross-foster and restricted gestational exposures. *Toxicol Sci* 95(2):462-473.
- Wolf CJ, Rider CV, Lau C, et al. 2014. Evaluating the additivity of perfluoroalkyl acids in binary combinations on peroxisome proliferator-activated receptor- α activation. *Toxicology* 316:43-54. 10.1016/j.tox.2013.12.002.
- Wolf CJ, Schmid JE, Lau C, et al. 2012. Activation of mouse and human peroxisome proliferator-activated receptor- α (PPAR α) by perfluoroalkyl acids (PFAAs): Further investigation of C4-C12 compounds. *Reprod Toxicol* 33:546-551.
- Wolf CJ, Takacs ML, Schmid JE, et al. 2008a. Activation of mouse and human peroxisome proliferator-activated receptor α by perfluoroalkyl acids of different functional groups and chain lengths. *Toxicol Sci* 106(1):162-171.
- +Wolf CJ, Zehr RD, Schmid JE, et al. 2010. Developmental effects of perfluorononanoic Acid in the mouse are dependent on peroxisome proliferator-activated receptor- α . *PPAR Res* 2010 10.1155/2010/282896.
- Wolf DC, Moore T, Abbott BD, et al. 2008b. Comparative hepatic effects of perfluorooctanoic acid and WY 14,643 in PPAR- α knockout and wild-type mice. *Toxicol Pathol* 36(4):632-639. 10.1177/0192623308318216.
- Wong F, MacLeod M, Mueller JF, et al. 2014. Enhanced elimination of perfluorooctane sulfonic acid by menstruating women: Evidence from population-based pharmacokinetic modeling. *Environ Sci Technol* 48(15):8807-8814.
- Wong F, MacLeod M, Mueller JF, et al. 2015. Response to comment on "Enhanced elimination of perfluorooctane sulfonic acid by menstruating women: Evidence from population-based pharmacokinetic modeling." *Environ Sci Technol* 49(9):5838-5839.
- Worley RR, Fisher J. 2015a. Application of physiologically-based pharmacokinetic modeling to explore the role of kidney transporters in renal reabsorption of perfluorooctanoic acid in the rat. *Toxicol Appl Pharmacol* 289(3):428-441. 10.1016/j.taap.2015.10.017.
- Worley RR, Fisher J. 2015b. Supplementary material: Application of physiologically-based pharmacokinetic modeling to explore the role of kidney transporters in renal reabsorption of perfluorooctanoic acid in the rat. *Toxicol Appl Pharmacol* 289(3):428-441.
- Worley RR, Moore SM, Tierney BC, et al. 2017a. Per- and polyfluoroalkyl substances in human serum and urine samples from a residentially exposed community. *Environ Int* 106:135-143. 10.1016/j.envint.2017.06.007.

8. REFERENCES

- Worley RR, Yang X, Fisher J. 2017b. Physiologically based pharmacokinetic modeling of human exposure to perfluorooctanoic acid suggests historical non drinking-water exposures are important for predicting current serum concentrations. *Toxicol Appl Pharmacol* 330:9-21. 10.1016/j.taap.2017.07.001.
- Woskie SR, Gore R, Steenland K. 2012. Retrospective exposure assessment of perfluorooctanoic acid serum concentrations at a fluoropolymer manufacturing plant. *Ann Occup Hyg* 56(9):1025-1037. 10.1093/annhyg/mes023.
- Wu LL, Gao HW, Gao NY, et al. 2009. Interaction of perfluorooctanoic acid with human serum albumin. *BMC Struct Biol* 9:31.
- Wu XM, Bennett DH, Calafat AM, et al. 2015. Serum concentrations of perfluorinated compounds (PFC) among selected populations of children and adults in California. *Environ Res* 136:264-273. 10.1016/j.envres.2014.09.026.
- +Xia W, Wan Y, Li YY, et al. 2011. PFOS prenatal exposure induce mitochondrial injury and gene expression change in hearts of weaned SD rats. *Toxicology* 282(1-2):23-29.
- Xiao F, Simcik MF, Halbach TR, et al. 2015. Perfluorooctane sulfonate (PFOS) and perfluorooctanoate (PFOA) in soils and groundwater of a U.S. metropolitan area: Migration and implications for human exposure. *Water Res* 72:64-74.
- +Xie Y, Yang Q, Nelson BD, et al. 2003. The relationship between liver peroxisome proliferation and adipose tissue atrophy induced by peroxisome proliferator exposure and withdrawal in mice. *Biochem Pharmacol* 66(5):749-756.
- +Xing J, Wang G, Zhao J, et al. 2016. Toxicity assessment of perfluorooctane sulfonate using acute and subchronic male C57BL/6J mouse models. *Environ Pollut* 210:388-396. 10.1016/j.envpol.2015.12.008.
- Xu J, Shimpi P, Armstrong L, et al. 2016. PFOS induces adipogenesis and glucose uptake in association with activation of Nrf2 signaling pathway. *Toxicol Appl Pharmacol* 290:21-30.
- +Yahia D, El-Nasser MA, Abedel-Latif M, et al. 2010. Effects of perfluorooctanoic acid (PFOA) exposure to pregnant mice on reproduction. *J Toxicol Sci* 35(4):527-533.
- +Yahia D, Tsukuba C, Yoshida M, et al. 2008. Neonatal death of mice treated with perfluorooctane sulfonate. *J Toxicol Sci* 33(2):219-226.
- Yamada A, Maeda K, Kamiyama E, et al. 2007. Multiple human isoforms of drug transporters contribute to the hepatic and renal transport of olmesartan, a selective antagonist of the angiotensin II AT1-receptor. *Drug Metab Dispos* 35(12):2166-2176. 10.1124/dmd.107.017459.
- Yamada T, Taylor PH, Buck RC, et al. 2005. Thermal degradation of fluorotelomer treated articles and related materials. *Chemosphere* 61:974-984.
- Yamaguchi M, Arisawa K, Uemura H, et al. 2013. Consumption of seafood, serum liver enzymes, and blood levels of PFOS and PFOA in the Japanese population. *J Occup Health* 55(3):184-194.
- Yamashita N, Kannan K, Taniyasu S, et al. 2005. A global survey of perfluorinated acids in oceans. *Mar Pollut Bull* 51:658-668.
- Yamashita N, Taniyasu S, Petrick G, et al. 2008. Perfluorinated acids as novel chemical tracers of global circulation of ocean waters. *Chemosphere* 70:1247-1255.
- Yang CH, Glover KP, Han X. 2009. Organic anion transporting polypeptide (Oatp) 1a1-mediated perfluorooctanoate transport and evidence for a renal reabsorption mechanism of Oatp1a1 in renal elimination of perfluorocarboxylates in rats. *Toxicol Lett* 190(2):163-171.
- Yang CH, Glover KP, Han X. 2010. Characterization of cellular uptake of perfluorooctanoate via organic anion-transporting polypeptide 1A2, organic anion transporter 4, and urate transporter 1 for their potential roles in mediating human renal reabsorption of perfluorocarboxylates. *Toxicol Sci* 117(2):294-302.
- Yang L, Li J, Lai J, et al. 2016a. Placental transfer of perfluoroalkyl substances and associations with thyroid hormones: Beijing prenatal exposure study. *Sci Rep* 6:21699. 10.1038/srep21699.

8. REFERENCES

- Yang L, Wang Z, Shi Y, et al. 2016b. Human placental transfer of perfluoroalkyl acid precursors: Levels and profiles in paired maternal and cord serum. *Chemosphere* 144:1631-1638. 10.1016/j.chemosphere.2015.10.063.
- +Yang Q, Abedi-Valugerdi M, Xie Y, et al. 2002a. Potent suppression of the adaptive immune response in mice upon dietary exposure to the potent peroxisome proliferator, perfluorooctanoic acid. *Int Immunopharmacol* 2(2-3):389-397.
- +Yang Q, Xie Y, Alexson SE, et al. 2002b. Involvement of the peroxisome proliferator-activated receptor alpha in the immunomodulation caused by peroxisome proliferators in mice. *Biochem Pharmacol* 63(10):1893-1900.
- +Yang Q, Xie Y, Depierre JW. 2000. Effects of peroxisome proliferators on the thymus and spleen of mice. *Clin Exp Immunol* 122(2):219-226.
- +Yang Q, Xie Y, Eriksson AM, et al. 2001. Further evidence for the involvement of inhibition of cell proliferation and development in thymic and splenic atrophy induced by the peroxisome proliferator perfluorooctanoic acid in mice. *Biochem Pharmacol* 62(8):1133-1140.
- Yao PL, Ehresman DJ, Rae JM, et al. 2014. Comparative *in vivo* and *in vitro* analysis of possible estrogenic effects of perfluorooctanoic acid. *Toxicology* 326:62-73. 10.1016/j.tox.2014.10.008.
- Yao X, Zhong L. 2005. Genotoxic risk and oxidative DNA damage in HepG2 cells exposed to perfluorooctanoic acid. *Mutat Res* 587:38-44.
- Yarwood G, Kembal-Cook S, Keinath M, et al. 2007. High-resolution atmospheric modeling of fluorotelomer alcohols and perfluorocarboxylic acids in the North American troposphere. *Environ Sci Technol* 41:5756-5762.
- Ye X, Kato K, Wong LY, et al. 2018a. Per- and polyfluoroalkyl substances in sera from children 3 to 11 years of age participating in the National Health and Nutrition Examination Survey 2013-2014. *Int J Hyg Environ Health* 221(1):9-16. 10.1016/j.ijheh.2017.09.011.
- Ye X, Kato K, Wong LY, et al. 2018b. Supporting information to "Per- and polyfluoroalkyl substances in sera from children 3 to 11 years of age participating in the National Health and Nutrition Examination Survey 2013-2014" [*Int J Hyg Environ Health* 221(1):9-16. 10.1016/j.ijheh.2017.09.011]. *Int J Hyg Environ Health* <https://www.sciencedirect.com/science/article/pii/S1438463917305886#sec0045>. December 19, 2017.
- Ye X, Strynar MJ, Nakayama SF, et al. 2008. Perfluorinated compounds in whole fish homogenates from the Ohio, Missouri, and Upper Mississippi Rivers, USA. *Environ Pollut* 156(3):1227-1232. 10.1016/j.envpol.2008.03.014.
- Yeung LW, Robinson SJ, Koschorreck J, et al. 2013. Part II. A temporal study of PFOS and its precursors in human plasma from two German cities in 1982-2009. *Environ Sci Technol* 47(8):3875-3882. 10.1021/es4004153.
- Ylinen M, Auriola S. 1990. Tissue distribution and elimination of perfluorodecanoic acid in the rat after single intraperitoneal administration. *Pharmacol Toxicol* 66:45-48.
- Ylinen M, Kojo A, Hanhijarvi H, et al. 1990. Disposition of perfluorooctanoic acid in the rat after single and subchronic administration. *Bull Environ Contam Toxicol* 44:46-53.
- Yoo H, Washington JW, Jenkins TM, et al. 2011. Quantitative determination of perfluorochemicals and fluorotelomer alcohols in plants from biosolid-amended fields using LC/MS/MS and GC/MS. *Environ Sci Technol* 45.
- Young CJ, Furdui VI, Franklin J, et al. 2007. Perfluorinated acids in Arctic snow: New evidence for atmospheric formation. *Environ Sci Technol* 41:3455-3461.
- Yu J, Hu J, Tanaka S, et al. 2009c. Perfluorooctane sulfonate (PFOS) and perfluorooctanoic acid (PFOA) in sewage treatment plants. *Water Res* 43(9):2399-2408.
- +Yu WG, Liu W, Jin YH. 2009a. Effects of perfluorooctane sulfonate on rat thyroid hormone biosynthesis and metabolism. *Environ Toxicol Chem* 28(5):990-996.

8. REFERENCES

- Yu WG, Liu W, Jin YH, et al. 2009b. Prenatal and postnatal impact of perfluorooctane sulfonate (PFOS) on rat development: A cross-foster study on chemical burden and thyroid hormone system. *Environ Sci Technol* 43(21):8416-8422.
- Yuan G, Peng H, Huang C, et al. 2016. Ubiquitous occurrence of fluorotelomer alcohols in eco-friendly paper-made food-contact materials and their implication for human exposure. *Environ Sci Technol* 50:942-950.
- Zeng H-c, Zhang L, Li Y-y, et al. 2011. Inflammation-like glial response in rat brain induced by prenatal PFOS exposure. *Neurotoxicology* 32(1):130-139.
- Zeng XW, Qian Z, Emo B. 2015. The association between perfluoroalkyl chemicals and serum lipid levels in children. *Sci Total Environ* 512-513:364-370
- Zhang C, Sundaram R, Maisog J, et al. 2015a. A prospective study of prepregnancy serum concentrations of perfluorochemicals and the risk of gestational diabetes. *Fertil Steril* 103(1):184-189.
- Zhang H, Shi Z, Liu Y, et al. 2008. Lipid homeostasis and oxidative stress in the liver of male rats exposed to perfluorododecanoic acid. *Toxicol Appl Pharmacol* 227:16-25.
- Zhang L, Ren X-M, Wan B, et al. 2014. Structure-dependent binding and activation of perfluorinated compounds on human peroxisome proliferator-activated receptor γ . *Toxicol Appl Pharmacol* 279(3):275-283.
- Zhang T, Sun H, Lin Y, et al. 2011. Perfluorinated compounds in human blood, water, edible freshwater fish, and seafood in China: Daily intake and regional differences in human exposures. *J Agric Food Chem* 59:11168-11176.
- Zhang T, Sun H, Qin X, et al. 2015b. PFOS and PFOA in paired urine and blood from general adults and pregnant women: Assessment of urinary elimination. *Environ Sci Pollut Res Int* 22(7):5572-5579. 10.1007/s11356-014-3725-7.
- Zhang X, Chen L, Fei XC, et al. 2009. Binding of PFOS to serum albumin and DNA: Insight into the molecular toxicity of perfluorochemicals. *BMC Mol Biol* 10:16.
- Zhang X, Lohmann R, Dassuncao C, et al. 2016. Source attribution of poly-and perfluoroalkyl substances (PFASs) in surface waters from Rhode Island and New York metropolitan area. *Environ Sci Technol Lett* 3:316-321. 10.1021/acs.estlett.6b00255.
- Zhang Y, Beesoon S, Zhu L, et al. 2013. Biomonitoring of perfluoroalkyl acids in human urine and estimates of biological half-life. *Environ Sci Technol* 47(18):10619-10627. 10.1021/es401905e.
- Zhao G, Wang J, Wang X, et al. 2011. Mutagenicity of PFOA in mammalian cells: Role of mitochondria-dependent reactive oxygen species. *Environ Sci Technol* 45(4):1638-1644.
- Zhao H, Qu B, Guan Y, et al. 2016. Influence of salinity and temperature on uptake of perfluorinated carboxylic acids (PFCAs) by hydroponically grown wheat (*Triticum aestivum* L.). *Springer Plus* 5:541.
- +Zheng L, Dong GH, Jin YH, et al. 2009. Immunotoxic changes associated with a 7-day oral exposure to perfluorooctanesulfonate (PFOS) in adult male C57BL/6 mice. *Arch Toxicol* 83(7):679-689.
- Zhu Y, Qin XD, Zeng XW, et al. 2016. Associations of serum perfluoroalkyl acid levels with T-helper cell-specific cytokines in children: By gender and asthma status. *Sci Total Environ* 559:166-173. 10.1016/j.scitotenv.2016.03.187.

APPENDIX A. ATSDR MINIMAL RISK LEVEL WORKSHEETS

MRLs are derived when reliable and sufficient data exist to identify the target organ(s) of effect or the most sensitive health effect(s) for a specific duration for a given route of exposure. An MRL is an estimate of the daily human exposure to a hazardous substance that is likely to be without appreciable risk of adverse noncancer health effects over a specified route and duration of exposure. MRLs are based on noncancer health effects only; cancer effects are not considered. These substance-specific estimates, which are intended to serve as screening levels, are used by ATSDR health assessors to identify contaminants and potential health effects that may be of concern at hazardous waste sites. It is important to note that MRLs are not intended to define clean-up or action levels.

MRLs are derived for hazardous substances using the NOAEL/uncertainty factor approach. They are below levels that might cause adverse health effects in the people most sensitive to such chemical-induced effects. MRLs are derived for acute (1–14 days), intermediate (15–364 days), and chronic (≥ 365 days) durations and for the oral and inhalation routes of exposure. Currently, MRLs for the dermal route of exposure are not derived because ATSDR has not yet identified a method suitable for this route of exposure. MRLs are generally based on the most sensitive substance-induced endpoint considered to be of relevance to humans. Serious health effects (such as irreparable damage to the liver or kidneys, or birth defects) are not used as a basis for establishing MRLs. Exposure to a level above the MRL does not mean that adverse health effects will occur.

MRLs are intended only to serve as a screening tool to help public health professionals decide where to look more closely. They may also be viewed as a mechanism to identify those hazardous waste sites that are not expected to cause adverse health effects. Most MRLs contain a degree of uncertainty because of the lack of precise toxicological information on the people who might be most sensitive (e.g., infants, elderly, nutritionally or immunologically compromised) to the effects of hazardous substances. ATSDR uses a conservative (i.e., protective) approach to address this uncertainty consistent with the public health principle of prevention. Although human data are preferred, MRLs often must be based on animal studies because relevant human studies are lacking. In the absence of evidence to the contrary, ATSDR assumes that humans are more sensitive to the effects of hazardous substance than animals and that certain persons may be particularly sensitive. Thus, the resulting MRL may be as much as 100-fold below levels that have been shown to be nontoxic in laboratory animals.

APPENDIX A

Proposed MRLs undergo a rigorous review process: Health Effects/MRL Workgroup reviews within the Division of Toxicology and Human Health Sciences, expert panel peer reviews, and agency-wide MRL Workgroup reviews, with participation from other federal agencies and comments from the public. They are subject to change as new information becomes available concomitant with updating the toxicological profiles. Thus, MRLs in the most recent toxicological profiles supersede previously published MRLs. For additional information regarding MRLs, please contact the Division of Toxicology and Human Health Sciences, Agency for Toxic Substances and Disease Registry, 1600 Clifton Road NE, Mailstop F-57, Atlanta, Georgia 30329-4027.

INTRODUCTION

Overview of Epidemiological Studies

A large number of epidemiology studies have evaluated a wide range of potential health outcomes resulting from exposure to perfluoroalkyls, particularly PFOA and PFOS. The epidemiology studies fall into three broad categories: occupational exposure primarily to airborne PFOA and PFOS, exposure to PFOA-contaminated drinking water by residents living near a PFOA production facility, and general population exposure to background levels of perfluoroalkyls. Most of the occupational exposure studies were conducted in workers at four facilities in Minnesota, Alabama, West Virginia, and the Netherlands. Studies of the highly-exposed residents primarily come from several large-scale studies (C8 Health Project, C8 Health Study) of Mid-Ohio Valley residents living near the Washington Works facility in West Virginia who were exposed to high levels of PFOA in the drinking water. General population studies primarily utilized data collected in NHANES in the United States and several large-scale health studies conducted in Europe.

Most of the epidemiology studies lack environmental monitoring data and there is a potential for multiple sources of exposure (inhalation and oral). However, the majority of the epidemiology studies used serum perfluoroalkyl levels as a biomarker of exposure. One limitation of the C8 Health Studies is that they used blood samples collected in 2005–2006. However, the facility started using PFOA in the 1950s and peak usage was in the 1990s and by 2003, there was an 87% decline in PFOA emissions, as compared to 1999 levels (Emmett et al. 2006a). Therefore, serum PFOA levels measured in 2005–2006 likely do not represent earlier higher exposures, which may have contributed to observed health outcomes. As an alternative to using older serum PFOA levels, several C8 Health Studies estimated serum levels based on data on the release of PFOA from the facility and pharmacokinetic modeling. Of the three categories of subjects examined in the epidemiology studies, workers have the highest potential exposure to perfluoroalkyls, followed by the highly-exposed residents in the Mid-Ohio Valley (referred to as community exposure), and then the general population. In one study of workers at the Washington Works facility in West Virginia, the average serum PFOA level in 2001–2004 was 1,000 ng/mL (Sakr et al. 2007a); the mean PFOA level in community residents (without occupational exposure) near this facility was 423 ng/mL in 2004–2005 (Emmett et al. 2006a). By comparison, the geometric mean concentration of PFOA in the U.S. population was 3.92 ng/mL in 2005–2006 (CDC 2013).

Identification of Adverse Health Effects Based on Epidemiological Studies—Weight-of-Evidence Approach. Although a large number of epidemiology studies have examined the potential of perfluoroalkyl compounds to induce adverse health effects, most of the studies were cross-sectional in design and do not establish causality. Epidemiology studies have found statistically significant associations between serum perfluoroalkyl levels and several health effects, although the results were not consistent across studies. Many of the studies reported dose-related trends, but these trends were not as apparent when comparing across studies; some effects were observed in populations with background PFOA levels but not in populations with high serum PFOA levels. Given the inconsistencies, a weight-of-evidence approach was used to evaluate whether the available data supported a link between perfluoroalkyl exposure and a particular health effect, taking into consideration the consistency of the findings across studies, the quality of the studies, dose-response, and plausibility. It should be noted that although the data may provide strong evidence for an association, it does not imply that the observed effect is biologically relevant because the magnitude of the change is within the normal limits or not indicative of an adverse health outcome. Plausibility depends primarily on experimental toxicology studies that establish a biological mechanism for the observed effects.

APPENDIX A

Using this weight-of-evidence approach, the available epidemiology data identify several potential health hazards of PFOA, PFOS, PFHxS, PFNA, and PFDeA in humans as listed below.

PFOA

- Pregnancy-induced hypertension/pre-eclampsia
- Liver damage, as evidenced by increases in serum enzymes and decreases in serum bilirubin levels
- Increases in serum lipids, particularly total cholesterol and LDL cholesterol
- Increased risk of thyroid disease
- Decreased antibody response to vaccines
- Increased risk of asthma diagnosis
- Increased risk of decreased fertility
- Small (<20 g or 0.7 ounces per 1 ng/mL increase in blood perfluoroalkyl level) decreases in birth weight

PFOS

- Pregnancy-induced hypertension/pre-eclampsia
- Liver damage, as evidenced by increases in serum enzymes and decreases in serum bilirubin levels
- Increases in serum lipids, particularly total cholesterol and LDL cholesterol
- Increased risk of thyroid disease
- Decreased antibody response to vaccines
- Increased risk of decreased fertility
- Small (<20 g or 0.7 ounces per 1 ng/mL increase in blood perfluoroalkyl level) decreases in birth weight

PFHxS

- Liver damage, as evidenced by increases in serum enzymes and decreases in serum bilirubin levels
- Decreased antibody response to vaccines

PFNA

- Increases in serum lipids, particularly total cholesterol and LDL cholesterol
- Decreased antibody response to vaccines

PFDeA

- Increases in serum lipids, particularly total cholesterol and LDL cholesterol
- Decreased antibody response to vaccines

Limitations of Epidemiological Data. There are sufficient epidemiology data to identify possible sensitive targets for many of the perfluoroalkyls; however, there are two major limitations to establishing dose-response relationships for these effects and using the epidemiology studies to derive MRLs: accurate identification of environmental exposure levels producing increased risk for adverse effects (exposure estimates and routes of exposure) and likely co-exposure to mixtures of perfluoroalkyls.

Uncertainty in Exposure Estimates. In general, the epidemiology studies provide a one-time serum perfluoroalkyl concentration, but lack information on actual environmental exposure concentration or doses, routes of exposure, and exposure duration. Although serum perfluoroalkyl levels provide reliable information on recent exposure (weeks to years, depending on the elimination $t_{1/2}$ for the perfluoroalkyl),

APPENDIX A

they likely do not reflect historical exposure levels or exposure levels at the onset of the effect. This is especially true for occupational exposure cohorts where past exposure levels were higher before industrial hygiene improved and in the C8 community studies since peak PFOA levels in drinking water occurred at least 10 years prior to the onset of the studies. Additionally, data from NHANES suggest that most perfluoroalkyl levels are declining in the general population; for example, the geometric mean serum levels of PFOA and PFOS declined from 5.21 and 30.4 ng/mL, respectively, in 1999–2000 to 2.08 and 6.31 ng/mL in 2011–2012. In contrast, levels of PFNA have increased during that time frame; the geometric mean went from 0.551 ng/mL in 1999–2000 to 1.26 ng/mL in 2009–2010 and then decreased to 0.881 ng/mL in 2011–2012. Most studies do not provide adequate information to determine whether perfluoroalkyl levels reflect a steady state and relatively constant exposure, since most designs only include a single measurement. An added uncertainty occurs in studies that used maternal serum levels as the biomarker of exposure for effects in children or for effects on fertility.

It is assumed that workers were primarily exposed via inhalation; however, oral exposure may have also contributed to the total perfluoroalkyl body burden, particularly since workers frequently lived in communities with elevated levels of PFOA in the drinking water. It has been determined that drinking water was the primary source of perfluoroalkyls in residents living near a PFOA facility (Emmett et al. 2006a); however, it is likely that airborne PFOA contributed to overall body burden. Drinking water is the likely primary route of exposure for the general population.

Uncertainty due to Co-Exposure to Other Perfluoroalkyl Compounds. Based on NHANES data, the U.S. general population is exposed to a variety of perfluoroalkyl compounds. A number of studies reported a high degree of correlation between perfluoroalkyl compounds; however, most studies did not control for exposure to other perfluoroalkyls. Given that many of the perfluoroalkyl compounds have similar targets of toxicity, it is likely that several perfluoroalkyls contributed to the observed effects. The potential interactions between different perfluoroalkyl compounds have not been fully elucidated.

In summary, the epidemiology databases for several perfluoroalkyls provide valuable information on hazard identification; however, uncertainties regarding doses associated with adverse effects and possible interactions between compounds preclude use of these data to derive MRLs.

Overview of Laboratory Animal Studies

Laboratory animal studies are available for 11 perfluoroalkyl compounds; however, more than 80% of the studies examined PFOA and/or PFOS. The laboratory animal studies primarily involved oral exposure and examined a wide range of potential health outcomes. The primary health effects observed in laboratory animals were liver toxicity, developmental toxicity, and immune toxicity. Other effects typically observed at higher doses included weight loss, histological alterations in reproductive tissues, and histological alterations in the thyroid gland. The sensitive targets of toxicity identified in the laboratory animals are similar to those observed in epidemiology studies.

Limitations of Laboratory Animal Studies for Derivation of MRLs. Use of controlled animal studies eliminates the uncertainties regarding effective doses and co-exposure to other perfluoroalkyl compounds. However, there are uncertainties associated with derivation of MRLs based on animal studies, in part, because of large interspecies differences in the toxicokinetics of perfluoroalkyls for which mechanisms are not completely understood. Available information on the toxicokinetics of perfluoroalkyls in humans, nonhuman primates, and various rodent species indicate that elimination rates (and very likely elimination mechanisms and hormonal regulation of these mechanisms) vary substantially across chemical species (i.e., carbon chain length) and animal species (i.e., slower in humans compared to nonhuman primates and rodents), and show pronounced sex differences within certain species (e.g., faster elimination in female rats). As a result, there is some uncertainty associated with

APPENDIX A

extrapolation of external dose-response relationships from animals to humans. Although progress has been made in modeling toxicokinetics of PFOA and PFOS in rats and nonhuman primates, no models for humans have been developed to simulate the substantial differences in toxicokinetics of these compounds between humans and nonhuman primates or between humans and rats (Andersen et al. 2006; Tan et al. 2008). An additional uncertainty in the animal data is the relevance of effects associated with activation of PPAR α . Many of the effects observed in rodents, particularly liver and developmental effects, involve the activation of PPAR α ; humans and nonhuman primates are less responsive to PPAR α agonists than rats and mice. However, studies in PPAR α -null mice suggest that PPAR α -independent mechanisms also play a role in the liver, immunological, and developmental toxicity.

MRL Approach

The following approach was used for derivation of MRLs:

- Identify sensitive endpoints from epidemiology studies
- Identify laboratory animal studies that have evaluated dose-response relationships for toxicity targets identified in epidemiology studies
- Estimate a point of departure (POD) using animal serum perfluoroalkyl levels for sensitive endpoints
- Calculate human equivalent doses (HEDs) using the assumption that a serum concentration resulting in an effect in a laboratory animal would also result in an effect in humans. An empirical pharmacokinetic model was used to estimate a human dose associated with this serum concentration for PFOA and PFOS. Measured serum concentrations in laboratory animal studies were used to calculate the HEDs for PFHxS and PFNA.
- Apply appropriate uncertainty factors informed by comparison of the POD to serum perfluoroalkyl levels reported in epidemiology studies

Predicting Mean Serum PFOA and PFOS Concentrations in Laboratory Animals. Time-weighted average (TWA) serum concentrations corresponding to external doses (mg/kg/day) and exposure durations (days) were predicted with a pharmacokinetic (PK) model for the animal species, strain, and sex used in the studies (Wambaugh et al. 2013). The TWA serum concentration was calculated as follows (Equation A-1):

$$C_{TWA} = \frac{C_{AUC}}{ED} \quad \text{Eq. (A-1)}$$

where C_{TWA} is the predicted TWA serum concentration (mg/L), C_{AUC} is the predicted area under the curve (AUC) of the serum concentration-time profile for the exposure (mg hour/L), and ED is the exposure duration (hour). Gavage studies were simulated as a single dose (e.g., gavage) given once every 24 hours. Daily drinking water exposures were simulated as 12 hourly doses of 1/12 of the total daily dose, followed by 12 hours with no dosing. This assumes that the animals consumed water during a 12-hour active period.

The Wambaugh et al. (2013) model was originally implemented in R (v2.10.0) and was migrated to MATLAB (vR2016) for calculations of MRLs. Wambaugh et al. (2013) reported mean and confidence limits for parameter values estimated from a Bayesian Markov Chain Monte Carlo (MCMC) analysis. The posterior means were used as point estimates for parameters in the MATLAB version. Function of the point estimate implementation in MATLAB was verified by comparing predictions of C_{AUC} obtained from the MATLAB version with predictions from the MCMC analysis reported in EPA (2016e, 2016f). This comparison for PFOA included a total of 18 predictions of C_{AUC} for female CD-1 mice (Lau et al. 2006; Wolf et al. 2007), female C57B16 mice (DeWitt et al. 2008), and male Sprague-Dawley rats

APPENDIX A

(Butenhoff et al. 2004b). The r^2 for MATLAB vs R predictions of C_{AUC} was 0.99 and the average relative percent difference (MATLAB - R) was 2.8% (range: -6.6–13.5). The comparison for PFOS included a total of 28 predictions of C_{AUC} for female CD-1 mice (Lau et al. 2003), female Sprague-Dawley rats (Butenhoff et al. 2009b; Lau et al. 2003; Luebker et al. 2005a, 2005b), and male and female Cynomolgus monkeys (Seacat et al. 2002). The r^2 for MATLAB vs R predictions of C_{AUC} was 1.00 and the average relative percent difference (MATLAB - R) was 4.6% (range: -11–20).

The Wambaugh et al. (2013) model was selected over other available pharmacokinetic models because it provided sex- and strain-specific parameters for rats, mice, and monkeys, which allowed for comparisons of HEDs across strains and species.

Estimating TWA Serum PFHxS and PFNA Concentrations in Laboratory Animals. Because a PK model for predicting the TWA serum concentrations was not identified for PFHxS and PFNA, a TWA serum concentration was estimated from measured serum concentrations. ATSDR estimated the TWA values from the areas under the curve calculated using the trapezoid rule. Since most studies did not report pre-exposure levels, serum concentrations in the control group were used as the baseline concentration.

Estimating HEDs for Perfluoroalkyls. The serum concentration PODs identified from the laboratory animal data were converted to an equivalent dose in humans, which is defined as the continuous ingestion dose (mg/kg/day) that would result in steady-state serum concentrations of perfluoroalkyl equal to the serum concentration ($\mu\text{g/mL}$) selected as the POD.

The relationship between perfluoroalkyl external dosage (mg/kg/day) and steady-state serum concentration (C_{ss} , mg/L) in humans was estimated assuming a single-compartment first-order model in which elimination kinetics are adequately represented by observed serum elimination $t_{1/2}$ values for the specific perfluoroalkyl compound, an assumed apparent volume of distribution (V_d , L/kg) and gastrointestinal absorption fraction. In the first-order single-compartment model, continuous exposure will result in a steady-state body burden (BB_{ss} , mg/kg) for PFOA or PFOS, which will be distributed in a single volume of distribution to yield a steady-state serum concentration (Equation A-2):

$$C_{ss} = \frac{BB_{ss}}{V_d} \quad \text{Eq. (A-2)}$$

At steady state, the rate of first-order elimination rate (a constant fraction of the body burden, k_e per day) will equal the absorbed dosage (D_{ss} , mg/kg/day) adjusted for gastrointestinal absorption (AF) (Equation A-3):

$$D_{ss} \cdot AF = BB_{ss} \cdot k_e \quad \text{Eq. (A-3)}$$

Rearrangement of Equation A-3 allows calculation of the steady-state body burden corresponding to a given external dosage (Equation A-4):

$$BB_{ss} = \frac{D_{ss} \cdot AF}{k_e} \quad \text{Eq. (A-4)}$$

APPENDIX A

The relationship between the elimination rate constant (k_e , day⁻¹) and the elimination half-life ($t_{1/2}$, day), is given in Equation A-5:

$$k_e = \frac{\ln(2)}{t_{1/2}} \quad \text{Eq. (A-5)}$$

Combining Equations A-2 and A-3 yields an expression relating the external steady-state dosage and steady-state serum concentration (Equation A-6):

$$D_{SS} = \frac{C_{SS} \cdot k_e \cdot V_d}{AF} \quad \text{Eq. (A-6)}$$

The above estimates of C_{SS}/D_{SS} are sensitive to the input parameters, $t_{1/2}$, AF, and V_d .

PFOA and PFOS. Several studies have estimated PFOA and PFOS half-lives ($t_{1/2}$) in workers (Costa et al. 2009; Olsen et al. 2007a) or highly exposed residents (Bartell et al. 2010). Estimates of the half-lives based on Olsen et al. (2007a) were derived from longitudinal measurements of serum concentrations of PFOA and PFOS in a group of fluorochemical production workers (24 males, 2 females); the estimated half-lives were 3.8 years (1,387 days) and 5.4 years (1,971 days), respectively. Costa et al. (2009) reported a half-life for PFOA of 5.1 years (1,862 days) for a group of workers (n=16) following their cessation of PFOA production work. A longitudinal study by Bartell et al. (2010) followed serum PFOA concentrations in 200 subjects recruited from the Lubeck Public Service District and Little Hocking Water Association and followed for a period of 6–12 months after mitigation of exposures from drinking water. The estimated half-life for PFOA was 2.3 years (840 days). A fourth study estimated half-lives in a cross-sectional study of residents served by the Lubeck Public Service District and Little Hocking Water Association (Seals et al. 2011). The estimated half-lives ranged from 2.9 to 10.1 years (1,059–3,687 days) for PFOA. Results from the longitudinal studies are shown in Table A-1. For the MRL calculations, the PFOA half-life estimated by Olsen et al. (2007a) was selected over the half-life estimated by Bartell et al. (2010) because the Olsen et al. (2007a) study had a longer follow-up time (>5 years compared to 6–12 months) and estimates of the terminal half-life appear to increase with longer follow-ups because slower kinetics make a larger contribution to the terminal half-life (Seals et al. 2011). Estimates of the half-life for PFOA and PFOS are most applicable to serum concentrations within the above ranges and would be less certain if applied to serum concentrations substantially below or above these range. Serum concentrations during the 5-year observation period in the Olsen et al. (2007a) study are provided in Table A-2.

Table A-1. Half-Life PFOA and PFOS Levels in Humans

PFOA $t_{1/2}$ (days)	PFOS $t_{1/2}$ (days)	Exposure type	Number	Source
1,387	1971	Occupational	26	Olsen et al. (2007a)
1,862	NA	Occupational	16	Costa et al. (2009)
840	NA	Environmental	200	Bartell et al. (2010)

PFOA = perfluorooctanoic acid; PFOS = perfluorooctane sulfonic acid

APPENDIX A

Table A-2. Serum PFOA and PFOS Concentrations Measured in Fluorochemical Production Workers

	PFOA (ppb)	PFOS (ppb)
Initial	408 (72, 5,100)	626 (145, 3,490)
Final	148 (17, 2,435)	295 (37, 1,740)

PFOA = perfluorooctanoic acid; PFOS = perfluorooctane sulfonic acid

Source: Olsen et al. 2007a

Estimates of volume of distribution (V_d) are based on non-compartmental modeling of serum concentration kinetics in monkeys and are assumed to be applicable to humans at the above serum concentrations (Table A-3).

Table A-3. Apparent Volume of Distribution for PFOA and PFOS

PFOA V_d (L/kg)	PFOS V_d (L/kg)	Source
0.18 (male)	NA	Butenhoff et al. (2004c)
0.20 (female)	NA	
NA	0.20 (male)	Chang et al. (2012)
NA	0.27 (female)	
0.3	0.3	Harada et al. (2005a)

NA = not applicable; PFOA = perfluorooctanoic acid; PFOS = perfluorooctane sulfonic acid

Numerous studies conducted in various animal models provide evidence for approximately complete absorption of oral doses of PFOA and PFOS (i.e., $AF \approx 1$, see Section 3.1.1).

PFHxS. For PFHxS, the estimate of the elimination $t_{1/2}$ was derived from longitudinal measurements of serum concentrations of PFHxS in a group of retired fluorochemical production workers (24 males and 2 females) observed for a 5-year period; the estimated half-life was 8.5 years (3,102 days) (Olsen et al. 2007a). The range of initial serum concentrations was 16–1,295 ng/mL (mean of 290 ng/mL), and the final concentrations ranged from 10 to 1,740 ng/mL (mean of 182 ng/mL). Estimates of the $t_{1/2}$ for PFHxS are most applicable to serum concentrations within the above ranges and would be less certain if applied to serum concentrations substantially below or above these range.

Estimates of volume of distribution (V_d) are based on non-compartmental modeling of serum concentration kinetics in monkeys and are assumed to be applicable to humans at the above serum concentrations. Sundström et al. (2012) estimate the apparent V_d for PFHxS at 0.287 L/kg for male Cynomolgus monkeys and at 0.213 L/kg for female Cynomolgus monkeys.

Few studies have been conducted in animals that provide estimates for a gastrointestinal absorption factor of oral doses of PFHxS. Sundström et al. (2012), based on comparison of the AUC for oral and intravenous administration, estimate an oral absorption fraction for PFHxS (administered as a single 10 mg/kg dose) of 50% in female rats. However, as the authors point out that this estimate may not be reliable due to the short (24 hours) observation period (Sundström et al. 2012) and that “female C_{max} values did not differ significantly between the oral and IV doses, and T_{max} after oral dosing was estimated to be at approximately 30 min.” These latter observations suggest approximately complete bioavailability. The AUC for male rats following oral exposure was not available, and the AUC after

APPENDIX A

intravenous administration was done in only one male rat. (Sundström et al. 2012). A study conducted by Kim et al. (2016) in rats estimated an approximately 100% oral bioavailability based on C_{max} value and AUC comparison between oral and intravenous doses. Therefore, an absorption fraction (AF) of 1 was used for PFHxS.

PFNA. For PFNA, the elimination half-life estimates were derived by paired blood and urine samples (n=86) from Chinese adults in a study that measured the concentrations of a number of perfluoroalkyl compounds, including PFNA (Zhang et al. 2013). The participants were first divided into four groups; young females (age ≤ 50 years, n=20), older females (>50 years, n=19), young males (≤ 50 years, n=32), and older males (>50 years, n=15). The group of young females had significantly lower levels of perfluoroalkyls than the other groups; therefore, the three other groups were combined. The lower perfluoroalkyl levels were likely due to the elimination via menstrual bleeding, pregnancy, and lactation. The estimated arithmetic mean elimination half-lives for the young female group and the combined male and older female group for PFNA were 2.5 and 4.3 years (913 and 1,570 days), respectively.

Toxicokinetics parameters for perfluorocarboxylic acids, among them PFOA and PFNA analogs, were investigated in rats by Ohmori et al. (2003). The authors estimated that the V_d values in steady state were not much different between the perfluorocarboxylic acids and between the sexes. Based on this, the estimate volume distribution for PFNA in humans will be assumed to be the same for PFOA, 0.2 L/kg.

There are no studies on absorption of PFNA in humans. In rodents, oral absorption occurs rapidly as indicated by its presence in the serum of rodents soon after oral administration (Tatum-Gibbs et al. 2011). Therefore, based on animal studies of PFNA and other perfluorocarboxylic acid analogs, as well as sufficient findings of PFNA and other perfluorocarboxylic acids in human blood, it can be assumed that PFNA is well absorbed after oral exposure; therefore, an AF of 1 was used.

Model Input Parameters. The first-order one-compartment model input parameters ($t_{1/2}$, V_d , and AF) are provided in Table A-4.

Table A-4. First Order One-Compartment Model Parameters

Parameter	PFOA	PFOS	PFHxS	PFNA
Serum elimination half-life ^a ; $t_{1/2}$ (day)	1,400 ^a	2,000 ^a	3,100 ^a	900 ^b
Serum elimination rate constant ^c , k_e (day ⁻¹)	4.95×10^{-4}	3.47×10^{-4}	2.23×10^{-4}	7.59×10^{-4}
Gastrointestinal absorption fraction ^d , AF	1	1	1	1
Apparent volume of distribution, V_d (L/kg)	0.2 ^e	0.2 ^e	0.287 ^f	0.2 ^e

^aEstimates from Olsen et al. (2007a).

^bEstimates from Zhang et al. (2013) for young females.

^cCalculated using Equation 5.

^dBased on studies in rodents and nonhuman primates.

^eEstimates based on studies in nonhuman primates (Butenhoff et al. 2004c; Chang et al. 2012; Harada et al. 2005a).

^fEstimates based on studies in nonhuman male primates (Sundström et al. 2012).

PFOA = perfluorooctanoic acid; PFOS = perfluorooctane sulfonic acid; PFHxS = perfluorohexane sulfonic acid; PFNA = perfluorononanoic acid

APPENDIX A

MINIMAL RISK LEVEL (MRL) WORKSHEET

Chemical Name: Perfluorooctanoic acid (PFOA)
CAS Numbers: 335-67-1
Date: June 2018
Profile Status: Final, Pre-Public Comment
Route: Inhalation
Duration: Acute

MRL Summary: There are insufficient data for derivation of an acute-duration inhalation MRL for PFOA.

Rationale for Not Deriving an MRL: Derivation of an inhalation MRL was precluded because inhalation-specific PBPK/pharmacokinetic model parameters are not available for PFOA and none of the studies reported serum PFOA concentrations.

Four studies have examined the acute toxicity of airborne PFOA in laboratory animals (Griffith and Long 1980; Kennedy et al. 1986; Staples et al. 1984). The observed effects included excessive salivation and eye and nose irritation in rats exposed to 18,600 mg/m³ for 1 hour (Griffith and Long 1980), weight loss and pulmonary edema in rats exposed to 380 mg/m³ for 4 hours (Kennedy et al. 1986), weight loss in rats exposed nose-only to 84 mg/m³ 6 hours/day, 5 days/week for 2 weeks (Kennedy et al. 1986), and decreases in maternal weight gain at 10 mg/m³ and maternal deaths and decreases in neonatal body weight at 25 mg/m³ in rats exposed 6 hours/day on GDs 6–15 (Staples et al. 1984). The 2-week study also reported increases in liver weight and hepatocellular hypertrophy in rats exposed to 7.6 mg/m³.

Agency Contacts (Chemical Managers): Selene Chou

APPENDIX A

MINIMAL RISK LEVEL (MRL) WORKSHEET

Chemical Name: Perfluorooctanoic acid (PFOA)
CAS Numbers: 335-67-1
Date: June 2018
Profile Status: Final, Pre-Public Comment
Route: Inhalation
Duration: Intermediate

MRL Summary: There are insufficient data for derivation of an intermediate-duration inhalation MRL for PFOA.

Rationale for Not Deriving an MRL: No intermediate-duration inhalation studies in laboratory animals were identified for PFOA.

Agency Contacts (Chemical Managers): Selene Chou

APPENDIX A

MINIMAL RISK LEVEL (MRL) WORKSHEET

Chemical Name: Perfluorooctanoic acid (PFOA)
CAS Numbers: 335-67-1
Date: June 2018
Profile Status: Final, Pre-Public Comment
Route: Inhalation
Duration: Chronic

MRL Summary: There are insufficient data for derivation of a chronic-duration inhalation MRL for PFOA.

Rationale for Not Deriving an MRL: No chronic-duration inhalation studies in laboratory animals were identified for PFOA.

Agency Contacts (Chemical Managers): Selene Chou

APPENDIX A

MINIMAL RISK LEVEL (MRL) WORKSHEET

Chemical Name: Perfluorooctanoic acid (PFOA)
CAS Numbers: 335-67-1
Date: June 2018
Profile Status: Final, Pre-Public Comment
Route: Oral
Duration: Acute

MRL Summary: There are insufficient data for derivation of an acute-duration oral MRL for PFOA.

Rationale for Not Deriving an MRL: An acute-duration oral MRL cannot be derived for PFOA because the modeling approach used for estimating HEDs cannot be used to estimate acute human exposure where the exposure duration of 14 days is 1% of the elimination half-life in humans.

Acute-duration oral studies are available in rats and mice and provide information on body weight, hepatic, immunological, reproductive, and developmental effects. The liver effects consisted of increases in liver weight, hepatocellular hypertrophy, and/or decreases in serum cholesterol and triglyceride in rats and mice exposed to ≥ 1 mg/kg/day (Cook et al. 1992; Elcombe et al. 2010; Haughom and Spydevold 1992; Ikeda et al. 1985; Kawashima et al. 1995; Kennedy 1987; Liu et al. 1996; Pastoor et al. 1987; Iwai and Yamashita 2006; Permadi et al. 1992, 1993; Vetvicka and Vetvickova 2013; White et al. 2009; Wolf et al. 2007; Xie et al. 2003; Yang et al. 2000, 2001, 2002b). Consistent with the Hall et al. (2012) criteria (see Section 2.9 for a discussion of the criteria), the liver weight increases and hypertrophy observed in rats and mice were not considered relevant to human risk assessment. The immunological effects consisted of impaired responses to T-dependent antigens, such as sRBCs, altered antibody response, and decreases in spleen and thymus weights at 11.5 mg/kg/day and higher (DeWitt et al. 2009; Vetvicka and Vetvickova 2013; Yang et al. 2001, 2002a). Information on the potential reproductive toxicity of PFOA is limited to three studies that reported increases in serum estradiol levels in rats exposed to ≥ 2 mg/kg/day for 14 days (Biegel et al. 1995; Cook et al. 1992; Liu et al. 1996). A number of studies have evaluated the developmental toxicity of PFOA. In the only acute-duration developmental toxicity study in rats, no alterations in fetal body weight or malformations were observed at 100 mg/kg/day (Staples et al. 1984). Mice appear to be more sensitive to PFOA's developmental toxicity; observed effects include decreases in litter weight (Hu et al. 2010), decreases in pup body weight (White et al. 2007, 2009; Wolf et al. 2007), alterations in spontaneous activity (Johansson et al. 2008), and delays in mammary gland development (White et al. 2007, 2009; Wolf et al. 2007). The lowest LOAEL for developmental effects in mice was 0.5 mg/kg/day for decreased litter weight. A list of the NOAEL and LOAEL values for the immunological, reproductive, and developmental effects is presented in Table A-5.

APPENDIX A

Table A-5. Summary of the Adverse Effects Observed in Laboratory Animals Following Acute-Duration Oral Exposure

Species and exposure duration	NOAEL (mg/kg/day)	LOAEL (mg/kg/day)	Effect	Reference
Immunological				
Mouse 10 days		11.5	Decreased spleen and thymus weights	Yang et al. 2001
Mouse 10 days	7.5	15	Altered response to sRBC	DeWitt et al. 2009
Mouse 7 days		20	Altered response to sRBC, decreased antibody formation	Vetvicka and Vetvickova 2013
Mouse 7 days		24	Decreased response to horse red blood cells	Yang et al. 2002a
Reproductive				
Rat 14 days	0.2	2	2-Fold increase in serum estradiol levels	Liu et al. 1996
Rat 14 days	1	10	63% increase in serum estradiol levels	Cook et al. 1992
Rat 14 days		25	184% increase in serum estradiol levels	Biegel et al. 1995
Developmental				
Mouse GDs 6–17		0.5	Decreased litter weight on PND 2	Hu et al. 2010
Mouse PND 10		0.58	Decreased spontaneous behavior and altered response to cholinergic stimulant	Johansson et al. 2008
Mouse GDs 8–17 or 12–17		5	Altered mammary gland development, decreased pup body weight on PND 20	White et al. 2007
Mouse GDs 8–17		5	Delayed mammary gland development, decreased pup body weight on PND 20	White et al. 2007
Mouse Various GDs		5	Delayed mammary gland development; decreased pup body weight at weaning	White et al. 2009 Wolf et al. 2007

GD = gestation day; LOAEL = lowest-observed-effect level; NOAEL = no-observed-adverse-effect level; PND = postnatal day; sRBC = sheep red blood cell

The lowest LOAEL values were identified for developmental effects; Hu et al. (2010) identified a LOAEL of 0.5 mg/kg/day for decreases in litter weight on PND 2 and Johansson et al. (2008) identified a LOAEL of 0.58 mg/kg for decreases in spontaneous behavior (locomotion and total activity) and decreased response to a cholinergic stimulant in adult mice exposed to PFOA on PND 10. Neither study identified NOAEL values.

Agency Contacts (Chemical Managers): Selene Chou

APPENDIX A

MINIMAL RISK LEVEL (MRL) WORKSHEET

Chemical Name:	Perfluorooctanoic acid (PFOA)
CAS Numbers:	335-67-1
Date:	June 2018
Profile Status:	Final, Pre-Public Comment
Route:	Oral
Duration:	Intermediate
Provisional MRL:	3×10^{-6} mg/kg/day
Critical Effect:	Altered activity and skeletal alterations in offspring
Reference:	Onishchenko et al. 2011; Koskela et al. 2016
Point of Departure:	0.000821 mg/kg/day
Uncertainty Factor:	300
LSE Graph Key:	61, 67
Species:	Mouse

MRL Summary: A provisional intermediate-duration oral MRL of 3×10^{-6} mg/kg/day was derived for PFOA based on altered activity at 5–8 weeks of age and skeletal alterations at 13 and 17 months of age in the offspring of mice fed a diet containing PFOA on GD 1 through GD 21 (Koskela et al. 2016; Onishchenko et al. 2011). The MRL is based on a HED LOAEL of 0.000821 mg/kg/day and a total uncertainty factor of 300 (10 for use of a LOAEL, 3 for extrapolation from animals to humans with dosimetric adjustments, and 10 for human variability).

Selection of the Critical Effect: Intermediate-duration oral studies of PFOA in animals indicate that the liver, immune system, reproductive system, and the developing organism are the primary targets of toxicity because adverse outcomes were observed at lower doses than other effects and have been consistently observed across studies. A summary of the lower LOAEL values (and associated NOAEL values) for these tissues/systems is presented in Table A-6; given the large number of studies, this table is limited to studies that identified LOAEL values of ≤ 4 mg/kg/day. Although these studies identified the lowest LOAEL values, not all were considered suitable as the basis of an intermediate-duration oral MRL.

Exposure to low levels of PFOA results in increases in liver weight, hepatocellular hypertrophy, and decreases in serum lipids in rats, mice, and monkeys exposed to PFOA for intermediate durations. The increases in liver weight, hepatocellular hypertrophy, and alterations in serum lipid levels observed in the rodents are likely due to peroxisome proliferation and are not considered relevant for human risk assessment (Hall et al. 2012). Consistent with the Hall et al. (2012) criteria, the increases in liver weight and hepatocellular hypertrophy, in the absence of other degenerative alterations, were not considered adverse. A small number of animal studies have reported degenerative lesions, lesions to specialty cells, bile duct lesions, or inflammation; these endpoints were considered relevant for human risk assessment (Butenhoff et al. 2004b; Cui et al. 2009; Loveless et al. 2008). The lowest LOAEL for adverse liver effects was 0.96 mg/kg/day for increased liver weight, hepatocellular hypertrophy, and focal necrosis in mice exposed for 28 days (Loveless et al. 2008). *In utero* exposure has also resulted in liver effects in offspring (Filgo et al. 2015a; Quist et al. 2015a); the lowest maternal LOAEL identified in these studies was 0.01 mg/kg/day (Quist et al. 2015a). Because the Quist et al. (2015a) study did not provide incidence data for the reported inflammation, this study was not considered suitable for derivation of an MRL. Hepatic effects consisting of increases in absolute liver weight at ≥ 3 mg/kg/day and increases in serum triglyceride levels at 30/20 mg/kg/day have also been observed in monkeys administered capsules containing PFOA (Butenhoff et al. 2002); no histological alterations were observed in surviving animals,

APPENDIX A

but hepatocellular degeneration and necrosis was noted in a monkey sacrificed early due to morbidity. The small number of animals examined and early deaths at several dose levels precludes using this study as the basis of an MRL. Two studies examining the immunotoxicity of PFOA following intermediate-duration oral exposure found decreases in antigen-specific antibody responses in mice exposed for 15 days (DeWitt et al. 2008, 2016); the lowest LOAEL was 1.88 mg/kg/day (DeWitt et al. 2016). Reproductive and developmental toxicity studies have identified very low LOAELs of ≥ 0.0024 mg/kg/day for delays in mammary gland development in dams and offspring (Macon et al. 2011; Tucker et al. 2015; White et al. 2011). However, the mammary gland effect did not result in an adverse effect on lactational support at maternal doses as high as 1 mg/kg/day, based on normal growth and survival in F2 pups (White et al. 2011). Given that milk production was adequate to support growth, the biological significance of the delayed development of the mammary gland is uncertain and was not considered a suitable basis for the MRL. Other developmental effects include increases in locomotor activity (Cheng et al. 2013; Onishchenko et al. 2011; Sobolewski et al. 2014) at ≥ 0.1 mg/kg/day, reduced ossification of proximal phalanges and advanced preputial separation at ≥ 1 mg/kg/day (Lau et al. 2006), altered long bone morphology and decreased bone mineral density in 13- and 17-month-old mice following *in utero* exposure to 0.3 mg/kg/day (Koskela et al. 2016), decreases in pup survival at ≥ 0.6 mg/kg/day (Abbott et al. 2007; Albrecht et al. 2013), decreases in the number of successful births at ≥ 3 mg/kg/day (Ngo et al. 2014), and reduced neonatal weight gain and delayed eye opening at ≥ 3 mg/kg/day (Wolf et al. 2007).

Table A-6. Summary of the Adverse Effects Observed in Laboratory Animals Following Intermediate-Duration Oral Exposure

Species and exposure duration	NOAEL (mg/kg/day)	LOAEL (mg/kg/day)	Effect	Reference
Hepatic				
Mouse GDs 1–17		0.01	Hepatocellular hypertrophy and periportal inflammation in offspring	Quist et al. 2015a, 2015b
Mouse 28 days	0.29	0.96	Moderate to severe hepatocellular hypertrophy and focal necrosis	Loveless et al. 2008
Mouse GDs 1–17 (examined at 18 months of age)	0.3	1	Increased severity of chronic inflammation in liver	Filgo et al. 2015a, 2015b
Rat 70–90 days	1	3	Increased liver weight, hepatocellular hypertrophy and necrosis	Butenhoff et al. 2004b
Monkey 26 weeks		3	Increased absolute liver weight	Butenhoff et al. 2002
Immunological				
Mouse 15 days	0.94	1.88	Reduced antibody response	DeWitt et al. 2016
Mouse 15 days	1.88	3.75	Reduced sRBC response	DeWitt et al. 2008

APPENDIX A

Table A-6. Summary of the Adverse Effects Observed in Laboratory Animals Following Intermediate-Duration Oral Exposure

Species and exposure duration	NOAEL (mg/kg/day)	LOAEL (mg/kg/day)	Effect	Reference
Reproductive				
Mouse GDs 1–17		0.0024	Delayed mammary gland development in dams (3-generation study)	White et al. 2011
Mouse GDs 1–17		1	Delayed mammary gland development in dams (single-generation study)	White et al. 2011
Developmental				
Mouse GD 7–PND 22		0.0024	Impaired development of mammary glands	White et al. 2011
Mouse GDs 10–17		0.01	Impaired development of mammary glands	Macon et al. 2011
Mouse GDs 1–17		0.01	Impaired development of mammary glands	Tucker et al. 2015
Mouse GD 7–PND 21		0.1	Neurodevelopmental	Sobolewski et al. 2014
Mouse GDs 1–21		0.3	Neurodevelopmental	Onishchenko et al. 2011
Mouse GDs 1–21		0.3	Skeletal alterations	Koskela et al. 2016
Mouse GDs 1–17		0.3	Impaired development of mammary glands	Macon et al. 2011
Mouse GDs 1–17	0.3	0.6	Decreased pup survival	Abbott et al. 2007
Mouse GDs 1–17		1	Reduced ossification of proximal phalanges and advanced preputial separation	Lau et al. 2006
Rat GD 1–PND 21		1.6	Neurodevelopmental	Cheng et al. 2013
Mouse GDs 1–17	0.1	3	Decreased number of successful births	Ngo et al. 2014
Mouse GDs 1–17		3	Reduced pups per litter on PND 20	Albrecht et al. 2013
Mouse GDs 1–17		3	Reduced weight gain, delayed eye opening	Wolf et al. 2007

GD = gestation day; LOAEL = lowest-observed-effect level; NOAEL = no-observed-adverse-effect level; PND = postnatal day; sRBC = sheep red blood cell

Selection of the Principal Study: As outlined in the MRL approach section, serum PFOA levels were predicted for the administered doses for most of the studies listed in Table A-6. Mean serum PFOA levels could not be predicted for four studies because pharmacokinetic model parameters were not available for Wistar rats (Cheng et al. 2013), male CD-1 mice (Loveless et al. 2008), or 129S1/SvImJ

APPENDIX A

wild-type mice (Abbott et al. 2007; Albrecht et al. 2013). A summary of the predicted serum PFOA levels is presented in Table A-7.

Table A-7. Summary of the Predicted TWA Serum PFOA levels in Laboratory Animals Following Intermediate-Duration Oral Exposure

Species and exposure duration	Dose (mg/kg/day)	Predicted TWA serum PFOA (µg/mL)	Effect	Reference
Hepatic				
CD Mouse	0.29	Not calculated	Moderate to severe hepatocellular hypertrophy and focal necrosis at 0.96 mg/kg/day	Loveless et al. 2008
28 days	0.96			
	9.6			
129/Sv Mouse	0.01	0.423	Increased severity of chronic inflammation in liver of offspring aged 18 months at 1 mg/kg/day	Filgo et al. 2015a, 2015b
GDs 1–17	0.1	4.21		
	0.3	12.5		
	1	39.2		
	5	102		
Sprague-Dawley Rat	1	60.4	Increased liver weight, hepatocellular hypertrophy and necrosis at 10 mg/kg/day	Butenhoff et al. 2004b
70–90 days	3	136		
	10	222		
	30	242		
Cynomolgus Monkey	3	68.5	Increased liver weight at 3 mg/kg/day	Butenhoff et al. 2002
6 months	10	93.8		
	20/30	113		
Immunological				
C58BL/6N Mouse	0.94	21.4	Reduced antibody response at 1.88 mg/kg/day	DeWitt et al. 2016
15 days	1.88	42.5		
	3.75	58.4		
	7.5	83.5		
C57BL/6N Mouse	0.94	21.4	Reduced sRBC response at 3.75 mg/kg/day	DeWitt et al. 2008
15 days	1.88	42.5		
	3.75	58.4		
	7.5	83.5		
	15	109		
	30	149		
Developmental				
C57BL/6 Mouse	0.1	2.23	Neurodevelopmental effects (increased horizontal and vertical activity and decreased resting activity) at 0.1 mg/kg/day	Sobolewski et al. 2014
GD 7–PND 21				
C57BL/6 Mouse	0.3	8.29	Skeletal alterations at 0.3 mg/kg/day	Koskela et al. 2016
GDs 1–21				
C57BL/6 Mouse	0.3	8.29	Neurodevelopmental (decreased number of inactive periods,	Onishchenko et al. 2011

APPENDIX A

Table A-7. Summary of the Predicted TWA Serum PFOA levels in Laboratory Animals Following Intermediate-Duration Oral Exposure

Species and exposure duration	Dose (mg/kg/day)	Predicted TWA serum PFOA (µg/mL)	Effect	Reference
GDs 1–21			altered novelty induced activity) at 0.3 mg/kg/day	
129S1/SvImJ Mouse GDs 1–17	0.1 0.3 0.6 1 3 5 10 20	Not calculated	Decreased pup survival at 0.6 mg/kg/day	Abbott et al. 2007
CD-1 Mouse GDs 1–17	1 3 5 10 20 40	39.2 83.6 102 125 155 205	Reduced ossification of proximal phalanges and advanced preputial separation at 1 mg/kg/day	Lau et al. 2006
Wistar Rat GD 1–PND 21	1.6	Not calculated	Neurodevelopmental effects (increased locomotor activity in males and decreased activity in females) at 1.6 mg/kg/day	Cheng et al. 2013
C57BL/6J Mouse GDs 1–17	0.1 3	2.43 62.0	Decreased number of successful births at 3 mg/kg/day	Ngo et al. 2014
SV/129 Mouse GDs 1–17	3	Not calculated	Reduced pups per litter on PND 20 at 3 mg/kg/day	Albrecht et al. 2013
CD-1 Mouse GDs 1–17	3 5	84.8 102	Reduced weight gain, delayed eye opening at 3 mg/kg/day	Wolf et al. 2007

GD = gestation day; PFOA = perfluorooctanoic acid; PND = postnatal day; sRBC = sheep red blood cell; TWA = time-weighted average

Selection of the Point of Departure for the MRL: The NOAEL/LOAEL and the benchmark dose (BMD) approaches were utilized to identify potential PODs for derivation of the intermediate-duration oral MRL for PFOA. The only datasets amenable to BMD modeling were from the DeWitt et al. (2008) and DeWitt et al. (2016) immunotoxicity studies. The results of the BMD modeling are presented at the end of this worksheet.

HEDs were calculated for each potential PODs (NOAEL, LOAEL, or BMDL value) identified in laboratory animal studies using the first order single-compartment model previously discussed and the assumption that humans would have similar effects as the laboratory animal at a given serum

APPENDIX A

concentration. The HEDs for each POD are presented in Table A-8. The potential POD_{HED} values were divided by an uncertainty factor to calculate candidate MRLs; these values are also presented in Table A-8. The candidate MRLs range from 7.4×10^{-7} mg/kg/day for neurodevelopmental effects in mice (Sobolewski et al. 2014) to 4.5×10^{-4} mg/kg/day for liver effects in male rats (Butenhoff et al. 2004b). The lowest LOAEL (expressed as predicted serum concentration) was identified in the Sobolewski et al. (2014) study, which found neurodevelopmental effects in mouse offspring at predicted serum PFOA concentration of 2.23 $\mu\text{g/mL}$. However, this study was not considered suitable as the basis of the MRL because the subroute and vehicle used for the controls (peanut oil with anisole administered via gavage) were different from the PFOA group (PFOA dissolved in water and added to diet). Rather, the Onishchenko et al. (2011) and Koskela et al. (2016) studies, which identified the second lowest LOAEL (serum PFOA concentration) of 8.29 $\mu\text{g/mL}$, were selected as the basis for the MRL; it is noted that these two studies used the offspring from the same animals.

APPENDIX A

Table A-8. Summary of Potential Points of Departures (PODs) and Human Equivalent Doses (HEDs) for Intermediate-Duration Oral MRL for PFOA

Endpoint (reference)	Predicted serum concentrations (µg/mL)		POD _{HED} ^a (mg/kg/day)	Total UF	Candidate MRLs (mg/kg/day)
	NOAEL or BMDL	LOAEL			
Neurodevelopmental effects (increased horizontal and vertical activity and decreased resting activity) in mice (Sobolewski et al. 2014)		2.23	0.000221	300 ^b	7.4x10 ⁻⁷
Neurodevelopmental effects (decreased number of inactive periods, altered novelty induced activity) in mice (Onishchenko et al. 2011)		8.29	0.000821	300 ^b	2.7x10 ⁻⁶
Skeletal alterations in mice (Koskela et al. 2016)		8.29	0.000821	300 ^b	2.7x10 ⁻⁶
Decreased number of successful births in mice (Ngo et al. 2014)	2.43	62.0	0.000241	30 ^c	8.0x10 ⁻⁶
Reduced ossification of proximal phalanges and advanced preputial separation in mice (Lau et al. 2006)		39.2	0.00388	300 ^b	1.3x10 ⁻⁵
Reduced weight gain and delayed eye opening (Wolf et al. 2007)		84.8	0.00840	300 ^b	2.8x10 ⁻⁵
Reduced response to dinitrophenyl-ficoll (DNP) antigen in female mice (DeWitt et al. 2016)	12.23 (BMDL _{1SD})		0.00121	30 ^c	4.0x10 ⁻⁵
Increased severity of chronic inflammation in liver of offspring aged 18 months (Filgo et al. 2015a, 2015b)	12.5	39.2	0.00124	30 ^c	4.1x10 ⁻⁵
Reduced response to sRBC in female mice (DeWitt et al. 2008)	33.49 (BMDL _{1SD})		0.00332	30 ^c	1.1x10 ⁻⁴
Increased liver weight, hepatocellular hypertrophy, and necrosis in male rats (Butenhoff et al. 2004b)	136	222	0.0135	30 ^c	4.5x10 ⁻⁴

^aBased on the NOAEL or BMDL; based on LOAEL if there was no NOAEL or BMDL.

^bUF of 10 for extrapolation from a LOAEL, 3 for extrapolation from animals to humans with dosimetric adjustments, and UF of 10 for human variability.

^cUF of 3 for extrapolation from animals to humans with dosimetric adjustments, and 10 for human variability.

BMDL = lower confidence limit on the BMD; HED = human equivalent dose; LOAEL = lowest-observed-adverse-effect level; MRL = Minimal Risk Level; NOAEL = no-observed-adverse-effect level; POD = point of departure; sRBC = sheep red blood cell; UF = uncertainty factor

Summary of the Principal Study:

Onishchenko et al. 2011. Prenatal exposure to PFOS or PFOA alters motor function in mice in a sex-related manner. *Neurotox Res* 19:452-461.

Koskela et al. 2016. Effects of developmental exposure to perfluorooctanoic acid (PFOA) on long bone morphology and bone cell differentiation. *Toxicol Appl Pharmacol* 301:14-21.

Neurobehavioral effects were assessed in offspring of C57BL/6/Bk1 mice that were exposed to PFOA (96% pure) in food at dose levels of 0 mg/kg/day (n=10) or 0.3 mg/kg/day (n=6) from GD 1 throughout pregnancy (presumed GD 21). PFOA was dissolved in ethanol and applied to palatable food in volumes adjusted according to individual body weights to provide 0.3 mg/kg/day, followed by evaporation of ethanol; controls received food with ethanol applied and then evaporated.

Onishchenko et al. (2011) study: Endpoints examined in the included maternal body weight during pregnancy; litter size and sex ratio; body, brain and liver weights in pups at birth; and PFOA concentrations in whole brain and liver tissue samples from pups at birth. Pups were subcutaneously injected with microtransponders on PND 21, and tested (6–10/sex/group) for novelty-induced locomotor activity and circadian activity over 48 hours at age 5–8 weeks, elevated maze and forced swimming performance at age 5–8 weeks, and muscle strength and coordination at age 3–4 months. The locomotor test measured distance traveled in the first 30 minutes in a new cage. Circadian activity was measured as number of antenna crossings in the new cage over 48 hours, with activity in the first 3 hours analyzed separately as adaptation to a novel environment. The elevated plus maze test recorded number of entries and time spent in open or closed areas as indicators of anxiety-like behavior. The forced swimming test measured immobility duration (total of times floating passively for ≥ 2 seconds) as an indicator of depression-like behavior. Muscle strength was evaluated by latency to fall in a hanging wire test. Motor coordination was evaluated by latency to fall in an accelerating rotarod test.

Prenatal PFOA exposure was associated with increases in global activity and exploratory activity in adult offspring as indicated by statistically significant ($p < 0.05$ compared with controls) increased circadian activity in males (44–48% higher number of crossings over 48 hours in a new cage, occurring in both 12-hour dark phases and in the intervening 12-hour light phase, but not in the initial 3-hour novelty phase), and decreased total number of inactive periods in males and females (approximately 40 and 25% lower, respectively). No alterations were observed in the forced swimming test or hanging wire test. Mean PFOA concentrations in brain and liver tissue samples at birth were 0.7 and 16.3 $\mu\text{g/g}$ in exposed pups and below detection limits in control pups.

Koskela et al. (2016) study: Groups of five offspring were sacrificed at either 13 or 17 months of age. The following parameters were used to assess toxicity: body weight and morphometric/biochemical properties in bone (femurs and tibias) of offspring. Offspring body weight was significantly higher in comparison with controls at 13 and 17 months of age (9.9 and 7.8%, respectively). In 17-month-old offspring, there was a 6.8% increase in periosteal area of the femoral cortical bone and increases in the peri- and endosteal perimeters (3.2 and 5.2%, respectively) and the marrow area (10.0%); an increase in medullary area was also observed. There were no differences in femoral cortical bone area or femoral mineral density. In the tibia, the total area inside the periosteal envelope and the periosteal perimeter were increased (4.9 and 3.5%, respectively). Although the investigators noted in the text that tibial medullary areas were “essentially the same between groups,” data in Figure 2 of the paper show a significant increase at 17 months. Significant decreases in tibial mineral density were observed at 13 and 17 months. There were no significant differences in the tibial medullary area or the endosteal perimeter.

APPENDIX A

There was a trend for increasing maximum force (Fmax); however, the effect was not statistically significant. There were no significant effects on any other measured biochemical parameter in the femur or tibia (stiffness, maximum energy, absorption). Concentrations of PFOA in the femurs and tibias of treated animals were significantly higher (4–5 times) than controls at 13 and 17 months.

Calculation of Internal Dosimetric: TWA serum PFOA concentrations corresponding to external doses and exposure durations were predicted from a pharmacokinetic model (Wambaugh et al. 2013) using animal species-, strain-, and sex-specific parameters (see MRL approach section for details).

Human Equivalent Dose: HEDs were calculated based on the assumption that humans would have similar effects as the laboratory animal at a given serum concentration. HEDs that would result in steady-state serum concentrations of PFOA equal to the serum concentration selected as the POD were calculated using the first-order single-compartment model (see MRL approach section for details).

Uncertainty Factor: The LOAEL_{HED} is divided by a total uncertainty factor of 300:

- 10 for the use of a LOAEL
- 3 for extrapolation from animals to humans with dosimetric adjustment
- 10 for human variability

$$\begin{aligned} \text{Provisional MRL} &= \text{LOAEL}_{\text{HED}} \div \text{UFs} \\ 0.000821 \text{ mg/kg/day} &\div (10 \times 3 \times 10) = 3 \times 10^{-6} \text{ mg/kg/day} \end{aligned}$$

Other Additional Studies or Pertinent Information that Lend Support to this MRL: A discussion of the findings from epidemiology studies is presented in the MRL introduction section.

Benchmark Dose Modeling: BMD modeling was conducted for the DeWitt et al. (2008) and DeWitt et al. (2016) immunotoxicity studies. Using predicted TWA serum PFOA levels as the internal dosimetric, the IgM response data (summarized in Tables A-9 and A-10) were fit to all available continuous models in EPA's Benchmark Dose Software (BMDS, version 2.6.0). The following procedure for fitting continuous data was used: the simplest model (linear) was first applied to the data while assuming constant variance; if the data were consistent with the assumption of constant variance ($p \geq 0.1$), then the fit of the linear model to the means was evaluated and the polynomial, power, and Hill models were fit to the data while assuming constant variance. Adequate model fit was judged by three criteria: goodness-of-fit p-value ($p > 0.1$), visual inspection of the dose-response curve, and scaled residual at the data point (except the control) closest to the predefined benchmark dose response (BMR). Among all of the models providing adequate fit to the data, the lowest BMDL (the lower limit of a one-sided 95% CI on the BMD) was selected as a reasonably conservative POD when differences between the BMDLs estimated from these models are >2 – 3 -fold; otherwise, the BMDL from the model with the lowest Akaike's information criterion (AIC) was chosen. If the test for constant variance was negative, the linear model was run again while applying the power model integrated into the BMDS to account for nonhomogenous variance. If the nonhomogenous variance model provided an adequate fit ($p \geq 0.1$) to the variance data, then the fit of the linear model to the means was evaluated and the polynomial, power, and Hill models were fit to the data and evaluated while the variance model was applied. Model fit and POD selection proceeded as described earlier. For both datasets, a BMR of 1 SD change from the control was used.

APPENDIX A

Table A-9. T-Cell Independent IgM Antibody Response in C57BL/6N Female Mice Immunized with Sheep Red Blood Cells

Number of animals per group	Administered dose (mg/kg/day)	Predicted TWA serum PFOA concentration (µg/mL)	IgM antibody titers ^a [mean serum IgM titer (log ₂) to reach 0.5 OD]	SE ^a
8	0	0	7.28	0.13
8	0.94	21.4	7.39	0.07
8	1.88	42.5	7.08	0.10
8	3.75	58.4	6.75 ^b	0.09
8	7.5	83.5	6.61 ^b	0.12

^aData taken from Figure 3-C using GrabIt.

^bStatistically different from controls (p<0.05).

PFOA = perfluorooctanoic acid; SE = standard error; TWA = time-weighted-average

Source: DeWitt et al. 2008

Table A-10. T-Cell Independent IgM Antibody Response In C57BL/6 Female Mice Immunized with Dinitrophenyl-Ficoll

Number of animals per group	Administered dose (mg/kg/day)	Predicted TWA serum PFOA concentration (µg/mL)	T-cell independent IgM antibody response ^a [mean serum titer (log ₂) to reach 0.5 OD]	SD ^a
8	0	0	11.38	0.56
8	0.94	21.4	11.01	1.11
8	1.88	42.5	9.67 ^b	1.34
8	3.75	58.4	9.81 ^b	1.46
8	7.5	83.5	9.62 ^b	0.97

^aData taken from Figure 3b using GrabIt.

^bStatistically different from controls (p<0.05).

PFOA = perfluorooctanoic acid; SE = standard error; TWA = time-weighted-average

Source: DeWitt et al. 2016

The results of the BMD analysis of the DeWitt et al. (2008) and DeWitt et al. (2016) datasets are presented in Tables A-11 and A-12. For the DeWitt et al. (2008) data, the Hill model with constant variance provided the best fit to the IgM response data, as judged by the model with the lowest AIC since the range of BMDL values were sufficiently close; the fit of this model is presented in Figure A-1. For the DeWitt et al. (2016) IgM response data, constant variance models provided adequate fit; since the estimated BMDL values were not sufficiently close, the model with the lowest BMDL (Exponential 4) was selected; the fit of this model is presented in Figure A-2.

APPENDIX A

Table A-11. T-Cell Independent IgM Antibody Response in C57BL/6N Female Mice Immunized With Sheep Red Blood Cells Using Predicted TWA Serum PFOA as the Dose Metric (DeWitt et al. 2008)

Model	Test for significant difference p-value ^a	Variance p-value ^b	Means p-value ^b	Scaled residuals ^c			Overall AIC	BMD _{1SD} (ng/mL)	BMDL _{1SD} (ng/mL)
				Dose below BMC	Dose above BMC	Dose largest			
Constant variance									
Exponential (model 2) ^d	<0.0001	0.46	0.08	1.73	0.72	1.73	-50.41	ND	ND
Exponential (model 3) ^d	<0.0001	0.46	0.10	0.16	-1.30	1.33	-50.61	42.55	26.37
Exponential (model 4) ^d	<0.0001	0.46	0.08	1.73	0.72	1.73	-50.41	ND	ND
Exponential (model 5) ^d	<0.0001	0.46	0.36	-0.14	0.09	0.67	-52.34	44.11	33.33
Hill^{d,e}	<0.0001	0.46	0.41	-0.05	0.06	0.60	-52.47	43.57	33.49
Linear ^f	<0.0001	0.46	0.09	1.69	0.67	1.69	-50.66	ND	ND
Polynomial (2-degree) ^f	<0.0001	0.46	0.08	0.10	-1.41	1.43	-50.00	ND	ND
Polynomial (3-degree) ^f	<0.0001	0.46	0.08	0.10	-1.41	1.43	-50.00	ND	ND
Polynomial (4-degree) ^f	<0.0001	0.46	0.08	0.10	-1.41	1.43	-50.00	ND	ND
Power ^d	<0.0001	0.46	0.10	0.16	-1.32	1.35	-50.49	42.62	26.23

^aValues >0.05 fail to meet conventional goodness-of-fit criteria.

^bValues <0.10 fail to meet conventional goodness-of-fit criteria.

^cScaled residuals at doses immediately below and above the benchmark dose; also the largest residual at any dose.

^dPower restricted to ≥ 1 .

^eSelected model. Constant variance model provided adequate fit to variance data. With constant variance model applied, the only models that provided adequate fit to the means were the Exponential 3 and 5, Hill, and Power models. BMDLs for models providing adequate fit were considered to be sufficiently close (differed by <2–3-fold); therefore, the model with the lowest AIC was selected (Hill).

^fCoefficients restricted to be negative.

AIC = Akaike Information Criterion; BMD = maximum likelihood estimate of the exposure concentration associated with the selected benchmark response; BMDL = 95% lower confidence limit on the BMD (subscripts denote benchmark response: i.e., ₁₀ = exposure concentration associated with 10% extra risk); ND = not determined, model did not provide adequate fit; PFOA = perfluorooctanoic acid; SD = standard deviation; TWA = time-weighted average

APPENDIX A

Figure A-1. Predicted (Hill Model with Constant Variance, 1 Standard Deviation Benchmark Response) and Observed IgM Response Using Predicted TWA Serum PFOA as the Dose Metric

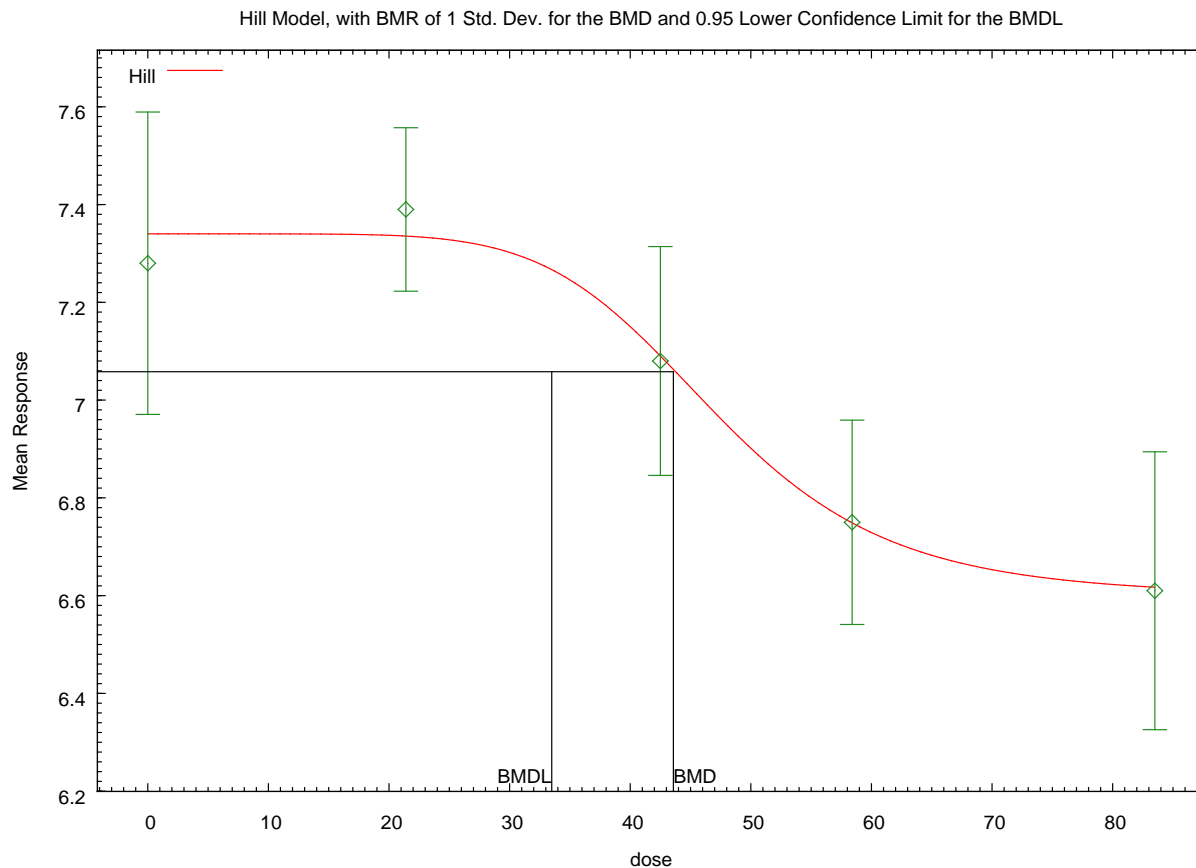

09:21 02/16 2017

APPENDIX A

Table A-12. T-Cell Independent IgM Antibody Response In C57BL/6 Female Mice Immunized With Dinitrophenyl-Ficoll Using Predicted TWA Serum PFOA as the Dose Metric (DeWitt et al. 2016)

Model	Test for significant difference p-value ^a	Variance p-value ^b	Means p-value ^b	Scaled residuals ^c			Overall AIC	BMD _{1SD} (ng/mL)	BMDL _{1SD} (ng/mL)
				Dose below BMC	Dose above BMC	largest			
Constant variance									
Exponential (model 2) ^d	0.0029	0.12	0.34	-1.47	-0.17	-1.47	54.00	45.00	29.56
Exponential (model 3) ^d	0.0029	0.12	0.34	-1.47	-0.17	-1.47	54.00	45.00	29.56
Exponential (model 4)^{d,e}	0.0029	0.12	0.31	1.01	-1.06	-1.06	54.97	29.22	12.23
Exponential (model 5) ^d	0.0029	0.12	0.71	0.00	-0.08	0.29	54.76	26.62	18.75
Hill ^d	0.0029	0.12	0.93	0.00	-0.08	0.29	52.76	23.66	19.11
Linear ^f	0.0029	0.12	0.30	-1.52	-0.23	-1.52	54.27	47.96	32.63
Polynomial (2-degree) ^f	0.0029	0.12	0.30	-1.52	-0.23	-1.52	54.27	47.96	32.63
Polynomial (3-degree) ^f	0.0029	0.12	0.30	-1.52	-0.23	-1.52	54.27	47.96	32.63
Polynomial (4-degree) ^f	0.0029	0.12	0.30	-1.52	-0.23	-1.52	54.27	47.96	32.63
Power ^d	0.0029	0.12	0.30	-1.52	-0.23	-1.52	54.27	47.96	32.63

^aValues >0.05 fail to meet conventional goodness-of-fit criteria.

^bValues <0.10 fail to meet conventional goodness-of-fit criteria.

^cScaled residuals at doses immediately below and above the benchmark dose; also the largest residual at any dose.

^dPower restricted to ≥ 1 .

^eSelected model. Constant variance model provided adequate fit to variance data. With constant variance model applied, all models provided adequate fit to the means. BMDLs for models providing adequate fit were not considered to be sufficiently close (differed by >2-fold, but <3-fold). In order to remain conservative, the model with the lowest BMDL was selected (Exponential 4).

^fCoefficients restricted to be negative.

AIC = Akaike Information Criterion; BMD = maximum likelihood estimate of the exposure concentration associated with the selected benchmark response; BMDL = 95% lower confidence limit on the BMD (subscripts denote benchmark response: i.e., ₁₀ = exposure concentration associated with 10% extra risk); NA = not applicable (BMDL computation failed); SD = standard deviation; TWA = time-weighted average

APPENDIX A

Figure A-2. Predicted (Exponential 4 Model with Constant Variance, 1 Standard Deviation Benchmark Response) and Observed IgM Response Using Predicted TWA Serum PFOA as the Dose Metric

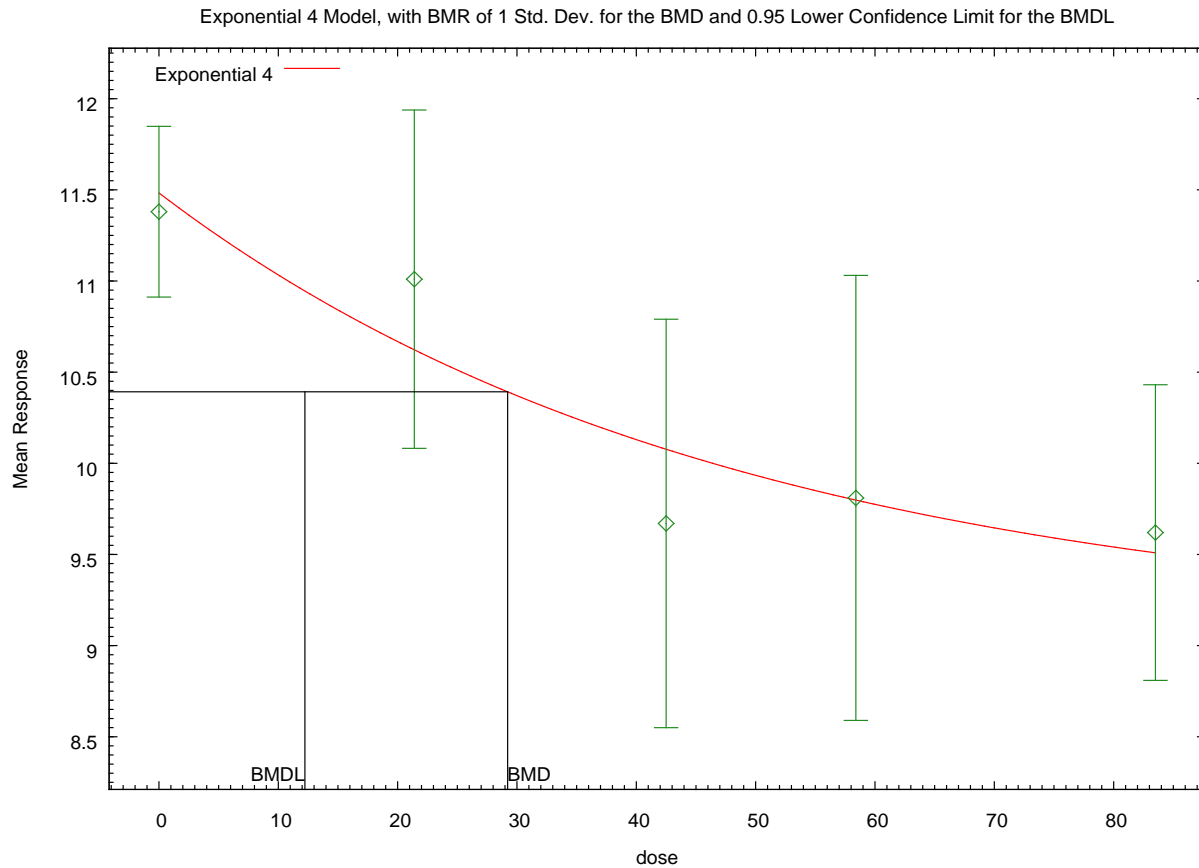

Agency Contacts (Chemical Managers): Selene Chou

APPENDIX A

MINIMAL RISK LEVEL (MRL) WORKSHEET

Chemical Name: Perfluorooctanoic acid (PFOA)
CAS Numbers: 335-67-1
Date: June 2018
Profile Status: Final, Pre-Public Comment
Route: Oral
Duration: Chronic

MRL Summary: There are insufficient data for derivation of a chronic-duration oral MRL for PFOA.

Rationale for Not Deriving an MRL: Intermediate-duration studies have identified the immune system as a sensitive target of PFOA toxicity. However, the potential immunotoxicity of PFOA has not been investigated in chronic-duration studies. Given the uncertainty that the chronic studies identified the most sensitive endpoint, a chronic-duration oral MRL for PFOA is not recommended at this time.

The chronic oral animal database for PFOA is limited to dietary exposure studies in male rats (3M 1983) or male and female rats (Biegel et al. 2001). The lowest LOAEL identified in the 3M (1983) study was 1.5 mg/kg/day for tubular hyperplasia in the ovaries and inflammation of salivary gland in rats exposed to PFOA in the diet for 2 years. At 15 mg/kg/day, hepatocellular necrosis was observed after 1 year of exposure and vascular mineralization was observed in the testes. In the Biegel et al. (2001) study, exposure to 13.6 mg/kg/day PFOA in the diet for 2 years resulted in decreases in body weight gain, increases in Leydig cell hyperplasia, and pancreatic acinar cell hyperplasia in male rats.

Agency Contacts (Chemical Managers): Selene Chou

APPENDIX A

MINIMAL RISK LEVEL (MRL) WORKSHEET

Chemical Name: Perfluorooctane sulfonic acid (PFOS)
CAS Numbers: 1763-23-1
Date: June 2018
Profile Status: Final, Pre-Public Comment
Route: Inhalation
Duration: Acute

MRL Summary: There are insufficient data for derivation of an acute-duration inhalation MRL for PFOS.

Rationale for Not Deriving an MRL: No inhalation studies in laboratory animals were identified for PFOS.

Agency Contacts (Chemical Managers): Selene Chou

APPENDIX A

MINIMAL RISK LEVEL (MRL) WORKSHEET

Chemical Name: Perfluorooctane sulfonic acid (PFOS)
CAS Numbers: 1763-23-1
Date: June 2018
Profile Status: Final, Pre-Public Comment
Route: Inhalation
Duration: Intermediate

MRL Summary: There are insufficient data for derivation of an intermediate-duration inhalation MRL for PFOS.

Rationale for Not Deriving an MRL: No inhalation studies in laboratory animals were identified for PFOS.

Agency Contacts (Chemical Managers): Selene Chou

APPENDIX A

MINIMAL RISK LEVEL (MRL) WORKSHEET

Chemical Name: Perfluorooctane sulfonic acid (PFOS)
CAS Numbers: 1763-23-1
Date: June 2018
Profile Status: Final, Pre-Public Comment
Route: Inhalation
Duration: Chronic

MRL Summary: There are insufficient data for derivation of a chronic-duration inhalation MRL for PFOS.

Rationale for Not Deriving an MRL: No inhalation studies in laboratory animals were identified for PFOS.

Agency Contacts (Chemical Managers): Selene Chou

APPENDIX A

MINIMAL RISK LEVEL (MRL) WORKSHEET

Chemical Name: Perfluorooctane sulfonic acid (PFOS)
CAS Numbers: 1763-23-1
Date: June 2018
Profile Status: Final, Pre-Public Comment
Route: Oral
Duration: Acute

MRL Summary: There are insufficient data for derivation of an acute-duration oral MRL for PFOS.

Rationale for Not Deriving an MRL: An acute-duration oral MRL for PFOS cannot be derived because the modeling approach used for estimating HEDs cannot be used to estimate acute human exposure where the exposure duration of 14 days is <1% of the PFOS elimination half-life in humans.

A number of studies have examined the toxicity of PFOS in laboratory animals following acute-duration exposure. The available data suggest that the liver, developing organism, and immune system are sensitive targets. The liver effects consisted of decreases in serum lipids, increases in liver weight, and hepatocellular hypertrophy (Elcombe et al. 2012a, 2012b; Era et al. 2009; Fuentes et al. 2006; Haughom and Spydevold 1992; Vetvicka and Vetvickova 2013; Wan et al. 2011); using the Hall et al. (2012) criteria (see Section 2.9 for a discussion of the criteria) for assessing the adversity of liver alterations for peroxisome proliferators, these effects were not considered relevant for human risk assessment. Immunological effects included altered responses to sRBC and decreased IgM antibody formation in response to antigen exposure in mice (Vetvicka and Vetvickova 2013; Zheng et al. 2009). Developmental effects consisted of decreases in neonatal survival (Abbott et al. 2009; Grasty et al. 2003), increases in post-implantation losses (Lee et al. 2015a), decreases in fetal body weight (Case et al. 2001; Era et al. 2009; Fuentes et al. 2007b; Lee et al. 2015a), increases in malformations (Era et al. 2009), and alterations in motor activity (Hallgren et al. 2015; Johansson et al. 2008). The lowest LOAEL identified was 0.5 mg/kg/day for increased post-implantation losses in mice (Lee et al. 2015a). A summary of the adverse effect levels for the immunological and developmental effects are presented in Table A-13.

Table A-13. Summary of the Adverse Effects Observed in Laboratory Animals Following Acute-Duration Oral Exposure to PFOS

Species and exposure duration	NOAEL (mg/kg/day)	LOAEL (mg/kg/day)	Effect	Reference
Immunological				
Mouse 7 days		5	Impaired response to T-cell mitogens; suppressed response to sRBC	Zheng et al. 2009
Mouse 7 days		20	Inhibition of T lymphocyte proliferation in response to sRBC; decreased phagocytosis by peripheral blood cells and NK cell activity; decreased IgM antibody formation in response to OVA	Vetvicka and Vetvickova 2013

APPENDIX A

Table A-13. Summary of the Adverse Effects Observed in Laboratory Animals Following Acute-Duration Oral Exposure to PFOS

Species and exposure duration	NOAEL (mg/kg/day)	LOAEL (mg/kg/day)	Effect	Reference
Developmental				
Mouse GDs 11–16		0.5	Increased post-implantation losses	Lee et al. 2015a
Mouse Once		0.75	Decreased motor activity	Johansson et al. 2008
Rabbit GDs 6–20	1	2.5	Decreased fetal body weight	Case et al. 2001
Mouse GDs 15–18		4.5	Decreased number of live pups per litter on PND 15	Abbott et al. 2009
Mouse GDs 12–18		6	Reduced pup body weight on PNDs 4 and 8	Fuentes et al. 2007b
Mouse Once		11.3	Altered spontaneous behavior in pups	Hallgren et al. 2015
Rat GDs 19–20		25	Decreased neonatal survival	Grasty et al. 2003
Rat GDs 2–5, 6–9, 10–13, 14–17, or 17–20		25	Decreased neonatal survival	Grasty et al. 2003
Mouse GDs 11–15		50	Cleft palate and reduced fetal body weight	Era et al. 2009

GD = gestation day; LOAEL = lowest-observed-effect level; NK = natural killer; NOAEL = no-observed-adverse-effect level; perfluorooctane sulfonic acid; PND = postnatal day; sRBC = sheep red blood cell

Agency Contacts (Chemical Managers): Selene Chou

APPENDIX A

MINIMAL RISK LEVEL (MRL) WORKSHEET

Chemical Name:	Perfluorooctane sulfonic acid (PFOS)
CAS Numbers:	1763-23-1
Date:	June 2018
Profile Status:	Final, Pre-Public Comment
Route:	Oral
Duration:	Intermediate
Provisional MRL:	2×10^{-6} mg/kg/day
Critical Effect:	Delayed eye opening and decreased pup body weight
Reference:	Luebker et al. 2005a
Point of Departure:	0.000515 mg/kg/day
Uncertainty Factor:	30
Modifying Factor:	10
LSE Graph Key:	34
Species:	Rat

MRL Summary: A provisional intermediate-duration oral MRL of 2×10^{-6} mg/kg/day was derived for PFOS based on delayed eye opening and transient decrease in F2 body weight during lactation in the offspring of rats administered PFOS via gavage in a 2-generation study (Luebker et al. 2005a). The MRL is based on a HED NOAEL of 0.000515 mg/kg/day and a total uncertainty factor of 30 (3 for extrapolation from animals to humans with dosimetric adjustments and 10 for human variability) and a modifying factor of 10 for concern that immunotoxicity may be a more sensitive endpoint than developmental toxicity).

Selection of the Critical Effect: Intermediate-duration studies in monkeys, rats, and mice have identified several sensitive targets of PFOS toxicity including the liver, nervous system, immune system, and the developing organism; adverse outcomes occurred in these tissues at lower doses than other effects. The lowest LOAEL and NOAEL values for these outcomes are presented in Table A-14; given the large number of intermediate-duration studies, this table was limited to studies which identified LOAEL values of ≤ 3 mg/kg/day. The liver effects observed in monkeys, rats, and mice included increases in liver weight, decreases in serum lipids, hepatocellular degeneration, and focal necrosis (Cui et al. 2009; Curran et al. 2008; Elcombe et al. 2012a; Lefebvre et al. 2008; Seacat et al. 2002, 2003; Thibodeaux et al. 2003; Wan et al. 2011; Yahia et al. 2008). In the absence of degenerative changes such as necrosis, the liver hypertrophy observed in rodent studies was not considered relevant to human risk assessment (Hall et al. 2012). Several studies have examined potential neurological endpoints and found overt signs of neurotoxicity (cachexia, lethargy, and tonic convulsions in response to stimuli) in rats exposed to 5 or 8.5 mg/kg/day (Cui et al. 2009; Kawamoto et al. 2011) and impaired spatial learning and memory in mice exposed to 2.15 mg/kg/day (Long et al. 2013). Four studies have evaluated the immune response of PFOS exposed mice following exposure to an antigen (sRBC) or a virus (Dong et al. 2009, 2011; Guruge et al. 2009; Peden-Adams et al. 2008). Although the studies have consistently reported adverse effects, there is considerable overlap in LOAEL values. Peden-Adams et al. (2008) identified the lowest LOAEL of 0.00166 mg/kg/day with a NOAEL of 0.000166 mg/kg/day for a suppressed response to sRBC in mice administered PFOS for 28 days. Longer duration studies (Dong et al. 2009, 2011) have identified NOAEL values (0.0083 and 0.0167 mg/kg/day) in mice exposed to PFOS for 60 days that are higher than the LOAELs identified in the Peden-Adams et al. (2008) study. It is noted that the studies used different mouse strains (B6C3F1 in the Peden-Adams study and C57BL/6N in the Dong studies), which may account for this difference. A variety of developmental effects have been observed in rats and mice; these include increases in postnatal mortality (Chen et al. 2012b; Lau et al. 2003; Luebker et al. 2005a, 2005b; Xia et al. 2011; Yahia et al. 2008), neurodevelopmental alterations (locomotor activity and impaired

APPENDIX A

learning) (Butenhoff et al. 2009b; Onishchenko et al. 2011; Wang et al. 2015c), developmental delays (Lau et al. 2003; Luebker et al. 2005a), and malformations and anomalies (sternal defects and cleft palate) (Era et al. 2009; Thibodeaux et al. 2003; Yahia et al. 2008). The Wang et al. (2015c) study showed that decreases in spatial learning were observed in rats exposed *in utero* and in rat pups exposed postnatally (PND 7). Other effects that occur at similar doses include decreases in body weight (Lefebvre et al. 2008; Luebker et al. 2005a, 2005b; Seacat et al. 2002) and alterations in thyroid hormone levels (decreases in T3 and T4 levels and increases in TSH levels) (Curran et al. 2008; Luebker et al. 2005b; Thibodeaux et al. 2003).

The most sensitive targets of PFOS toxicity in laboratory animals are similar to those identified in longer term epidemiology studies. These effects include liver damage and increases in serum lipids, decreased antibody response to vaccines, and small decreases in birth weight; epidemiology studies have not consistently found neurological effects to be associated with serum PFOS levels.

Table A-14. Summary of the Adverse Effects Observed in Laboratory Animals Following Intermediate-Duration Oral Exposure to PFOS

Species and exposure duration	NOAEL (mg/kg/day)	LOAEL (mg/kg/day)	Effect	Reference
Hepatic				
Monkey 26 weeks	0.03	0.75	Increased liver weight, decreased serum cholesterol, hepatocellular hypertrophy, lipid vacuolation	Seacat et al. 2002
Neurological				
Mouse 3 months	0.43	2.15	Impaired spatial learning and memory	Long et al. 2013
Immunological				
Mouse 28 days	0.00016	0.00166	Suppressed response to sRBC	Peden-Adams et al. 2008
Mouse 21 days	0.005	0.025	Decreased resistance to influenza virus	Guruge et al. 2009
Mouse 60 days	0.0083	0.083	Impaired response to sRBC	Dong et al. 2009
Mouse 60 days	0.0167	0.083	Impaired response to sRBC	Dong et al. 2011
Developmental				
Mouse GDs 1–21		0.3	Decreased locomotion, muscle strength, motor coordination in adult offspring	Onishchenko et al. 2011
Rat 84 days	0.1	0.4	Delayed eye opening	Luebker et al. 2005a
Rat 67 days		0.4	Decreased pup weight	Luebker et al. 2005b
Rat GD 1–PND 1		0.8	Decreases spatial learning	Wang et al. 2015c
Rat GD 0–PND 20	0.3	1	Increased locomotor activity and concurrent failure to habituate to	Butenhoff et al. 2009b

APPENDIX A

Table A-14. Summary of the Adverse Effects Observed in Laboratory Animals Following Intermediate-Duration Oral Exposure to PFOS

Species and exposure duration	NOAEL (mg/kg/day)	LOAEL (mg/kg/day)	Effect	Reference
			test environment in male pups on PND 17	
Mouse GDs 1–17		1	Delayed eye opening	Lau et al. 2003
Mouse GDs 0–17		1	Increased sternal defects	Yahia et al. 2008
Rat GDs 1–21	0.1	2	Increased postnatal mortality and severe lung histopathology	Chen et al. 2012b
Rat GDs 2–21	0.6	2	Increased neonatal mortality	Xia et al. 2011

GD = gestation day; LOAEL = lowest-observed-effect level; NK = natural killer; NOAEL = no-observed-adverse-effect level; PFOS = perfluorooctane sulfonic acid; PND = postnatal day; sRBC = sheep red blood cell

Selection of the Principal Study: Using the Wambaugh et al. (2013) pharmacokinetic model, TWA serum concentrations corresponding to external doses (mg/kg/day) and exposure durations (days) were predicted for the studies listed in Table A-14. Pharmacokinetic model parameters were not available for C57BL/6N mice, B6C3F1 mice, or Wistar rats, which precluded predicting TWA serum concentrations for the Long et al. (2013), Dong et al. (2009, 2011), Guruge et al. (2009), Peden-Adams et al. (2008), Wang et al. (2015c), Onishchenko et al. (2011), and Yahia et al. (2008) studies. The predicted serum PFOS levels for each administered dose is presented in Table A-15.

Table A-15. Summary of the Predicted TWA Serum PFOS levels in Laboratory Animals Following Intermediate-Duration Oral Exposure

Species and exposure duration	Dose (mg/kg/day)	Predicted TWA serum PFOS (µg/mL)	Effect	Reference
Hepatic				
Cynomolgus Monkey 26 weeks	0.03 (males)	7.81	Increased liver weight, decreased serum cholesterol, hepatocellular hypertrophy, mild bile stasis, lipid vacuolation at 0.75 mg/kg/day	Seacat et al. 2002
	0.15 (males)	37.8		
	0.75 (males)	150		
	0.03 (females)	7.72		
	0.15 (females)	37.6		
	0.75 (females)	146		
Neurological				
C57BL/6 Mouse 3 months	0.43	Not calculated	Impaired spatial learning and memory at 2.15 mg/kg/day	Long et al. 2013
	2.15			
	10.75			

APPENDIX A

Table A-15. Summary of the Predicted TWA Serum PFOS levels in Laboratory Animals Following Intermediate-Duration Oral Exposure

Species and exposure duration	Dose (mg/kg/day)	Predicted TWA serum PFOS (µg/mL)	Effect	Reference
Immunological				
B6C3F1 Mouse 28 days	0.00016	Not calculated	Suppressed response to sRBC at 0.00166 mg/kg/day	Peden-Adams et al. 2008
	0.00166			
	0.00331			
	0.0166			
	0.0331			
B6C3F1 Mouse 21 days	0.005	Not calculated	Decreased resistance to influenza virus at 0.025 mg/kg/day	Guruge et al. 2009
	0.025			
C57BL/6N Mouse 60 days	0.0083	Not calculated	Impaired response to sRBC at 0.083 mg/kg/day	Dong et al. 2009
	0.083			
	0.41667			
	0.8333			
C57BL/6N Mouse 60 days	0.0083	Not calculated	Impaired response to sRBC at 0.083 mg/kg/day	Dong et al. 2011
	0.0167			
	0.083			
	0.41667			
C57BL/6N Mouse 60 days	0.8333	Not calculated	Impaired response to sRBC at 0.083 mg/kg/day	Dong et al. 2011
	2.0833			
	0.0083			
	0.0167			
	0.083			
Developmental				
C57BL/6 Mouse GDs 1–21	0.3	Not calculated	Decreased locomotion, muscle strength, motor coordination in adult offspring at 0.3 mg/kg/day	Onishchenko et al. 2011
Sprague-Dawley Rat 84 days	0.1	7.43	Delayed eye opening in F1 pups and transient decrease in F2 pup body weight during lactation at 0.4 mg/kg/day	Luebker et al. 2005a
	0.4	29.7		
	1.6	119		
	3.2	238		
Sprague-Dawley Rat 67 days	0.4	24.1	Decreased pup weight per litter at birth and on LD 5 at 0.4 mg/kg/day	Luebker et al. 2005b
	0.8	48.1		
	1	60.1		
	1.2	72.2		
	1.6	96.2		
Sprague-Dawley Rat 67 days	3.2	120		
	0.8	Not calculated		
Wistar Rat GD 1–PND 1	0.8	Not calculated	Decreases spatial learning at 0.8 mg/kg/day	Wang et al. 2015c

APPENDIX A

Table A-15. Summary of the Predicted TWA Serum PFOS levels in Laboratory Animals Following Intermediate-Duration Oral Exposure

Species and exposure duration	Dose (mg/kg/day)	Predicted TWA serum PFOS (µg/mL)	Effect	Reference
Sprague-Dawley Rat GD 0–PND 20	0.1	3.75	Increased locomotor activity and concurrent failure to habituate to test environment in male pups on PND 17 at 1 mg/kg/day	Butenhoff et al. 2009b
	0.3	11.3		
	1	37.5		
CD-1 Mouse GDs 1–17	1	31.9	Delayed eye opening at 1 mg/kg/day	Lau et al. 2003
	5	146		
	10	216		
	15	244		
	20	260		
ICR Mouse GDs 0–17	1	Not calculated	Increased sternal defects at 1 mg/kg/day	Yahia et al. 2008
Sprague-Dawley Rat GDs 1–21	0.1	2.01	Increased postnatal mortality and severe lung histopathology at 2 mg/kg/day	Chen et al. 2012b
	2	40.1		
Sprague-Dawley Rat GDs 2–21	0.1	1.92	Increased neonatal mortality at 2 mg/kg/day	Xia et al. 2011
	0.6	11.5		
	2	38.3		

GD = gestation day; LD = lactation day; perfluorooctane sulfonic acid; PND = postnatal day; sRBC = sheep red blood cell; TWA – time-weighted average

Selection of the Point of Departure for the MRL: None of the studies with predicted serum PFOS levels had datasets that were amenable for BMD modeling; thus, the NOAEL/LOAEL approach was used to identify PODs for derivation of the intermediate-duration MRL for PFOS. A summary of the PODs is presented in Table A-16. HEDs were calculated for each potential POD (NOAEL or LOAEL) identified in laboratory animal studies using the first-order single-compartment model previously discussed and the assumption that humans would have similar effects as the laboratory animal at a given serum concentration. The HEDs for each POD are presented in Table A-16. The potential POD_{HED} values were divided by a total uncertainty factor to calculate candidate MRLs; these values are also presented in Table A-16. The lowest administered doses associated with adverse effects were found in the immunotoxicity studies conducted by Dong et al. (2009, 2011), Guruge et al. (2009), and Peden-Adams et al. (2008). These data could not be considered as PODs because TWA serum PFOS values could not be predicted due to the lack of pharmacokinetic model parameters for the two mouse strains tested. Although there is considerable overlap between the LOAEL for IgM response to sRBC (0.00166 mg/kg/day) identified in the Peden-Adams et al. (2008) 28-day study and the NOAELs for IgM response to sRBC (0.0083 and 0.0167 mg/kg/day) identified in the Dong et al. (2009, 2011) 60-day studies, the data do suggest that immunotoxicity could occur at <0.3 mg/kg/day (the lowest LOAEL identified in developmental toxicity studies).

APPENDIX A

Table A-16. Summary of Potential Points of Departures Human Equivalent Doses (POD_{HED}) for Intermediate-Duration Oral MRL for PFOS

Endpoint (reference)	Predicted serum concentrations (µg/mL)		POD _{HED} ^a (mg/kg/day)	Total UF	Candidate MRLs (mg/kg/day)
	NOAEL	LOAEL			
Increased rat pup mortality and lung histopathology (Chen et al. 2012b)	2.01	40.1	0.000139	300 ^b	4.6x10 ⁻⁷
Decreased rat pup weight at birth and on PND 4 (Luebker et al. 2005b)		24.1	0.00167	3,000 ^c	5.6x10 ⁻⁷
Delayed eye opening in mouse pups (Lau et al. 2003)		31.9	0.00221	3,000 ^c	7.4x10 ⁻⁷
Neurodevelopmental effects in male rat pups (Butenhoff et al. 2009b)	11.3	37.5	0.000780	300 ^b	2.6x10 ⁻⁶
Delayed eye opening and decreased F2 rat pup body weight (Luebker et al. 2005a)	7.43	29.7	0.000515	300 ^b	1.7x10 ⁻⁶
Increased neonatal mortality in rat pups (Xia et al. 2011)	11.5	38.3	0.000797	300 ^b	2.7x10 ⁻⁶
Hepatic effects in monkeys (Seacat et al. 2002)	37.8	150	0.00262	300 ^b	8.7x10 ⁻⁶

^aBased on the NOAEL or the LOAEL if NOAEL was not identified.

^bUncertainty factors (UF) of 3 for extrapolation from animals to humans with dosimetric adjustments and 10 for human variability and modifying factor (MF) of 10 for concern that immunotoxicity may be a more sensitive endpoint than developmental toxicity.

^cUF of 10 for extrapolation from a LOAEL, 3 for extrapolation from animals to humans with dosimetric adjustments, and UF of 10 for human variability and MF of 10 for concern that immunotoxicity may be a more sensitive endpoint than developmental toxicity.

LOAEL = lowest-observed-effect level; MRL = Minimal Risk Level; NOAEL = no-observed-adverse-effect level; perfluorooctane sulfonic acid; PND = postnatal day; UF = uncertainty factor

The serum PFOS concentrations predicted to occur at the lowest LOAEL values were 24.1, 29.7, and 31.9 µg/mL identified in the Luebker et al. (2005b), Luebker et al. (2005a), and Lau et al. (2003) studies; decreases in pup body weight and delays in eye opening were observed at these levels. Luebker et al. (2005a) was the only study that identified a NOAEL for these effects. The predicted serum concentration for this NOAEL dose was selected as the basis for the MRL.

Summary of the Principal Study:

Luebker DJ, Case MT, York RG, et al. 2005a. Two-generation reproduction and cross-foster studies of perfluorooctanesulfonate (PFOS) in rats. *Toxicol* 215: 126-148.

Groups of Sprague-Dawley rats (P generation) (35/sex/dose level) were administered PFOS (86.9% pure) by gavage in deionized water with 2% Tween-80 at doses of 0, 0.1, 0.4, 1.6, or 3.2 mg/kg/day for 6 weeks before mating and until sacrifice (after mating for males, GD 10 for some females, and PND 21 for the

APPENDIX A

remaining females). Body weight and feed consumption were evaluated during the dosing period. Prior to mating, 15 females per dose group were evaluated for estrous cycling. Ten females/dose group were sacrificed on GD 10 and the remaining females were allowed to give birth (F1 generation). Parental rats sacrificed on GD 10 were examined for number of corpora lutea, implantations, and viable and non-viable fetuses. Body weight of F1 was evaluated during lactation; also, F1 rats were assessed for developmental landmarks during lactation. On PND 22, the F1 rats were started on the same diet as the parental rats. At approximately PND 90, F1 were mated to produce the F2 generation. F1 males and females were killed as the P generation. F1 females and males were evaluated for vaginal patency and preputial separation, respectively. At age 24 days, F1 rats were administered three neurobehavioral tests (learning, memory retention, and avoidance memory). At the age of 70 days, F1 were administered three different neurobehavioral tests (neuromuscular coordination, swimming ability, learning, and memory). PFOS was analyzed in liver and blood from parental females and in liver from F1 on PND 21; and in liver and serum from parental males after mating and after 42–56 days of dosing.

There were no deaths in parental males or females and no clinical signs in parental males. High-dose parental males had significantly reduced terminal body weight (11% reduction). Absolute and relative food consumption was reduced during treatment in males by less than 10%. Parental females at 0.4 mg/kg/day and higher had localized areas of partial alopecia. Body weight of high-dose parental females was significantly lower during cohabitation and gestation (11% reduced). Absolute and relative food consumption were significantly reduced in high-dose parental females during pre-mating and gestation (>15%) and in 1.6 mg/kg/day parental females during lactation. Administration of PFOS did not affect any mating or fertility parameter. Estrous cycling was not affected. Examination of parental females sacrificed on GD 10 showed no significant effect on numbers of corpora lutea or implantations or viable and non-viable fetuses. Significant delivery observations for high-dose parental females included reduced number of implantations per delivered litter, decreased gestational length, increased number of dams with all pups dying on PND 1–4 (also at 1.6 mg/kg/day). Observation of F1 pups during PNDs 1–21 showed significantly reduced weight and decreased viability (≥ 1.6 mg/kg/day). Examination of dead F1 pups did not reveal a cause of death; no labored breathing was noted in pups at birth. Developmental delays were noted at 1.6 mg/kg/day (pinna unfolding, surface righting, and air righting), and 0.4 mg/kg/day (eye opening). Follow-up observations of 0.1 and 0.4 mg/kg/day offspring showed no alterations in body weight or food consumption, including F1 females during gestation and lactation. Sexual maturation was not affected in F1 males or females; no effects were noted in the neurobehavioral tests. Reproductive performance of F1 were not affected. Viability of F2 pups during PNDs 1–21 was not affected. F2 pup weight was significantly reduced at 0.4 mg/kg/day on PND 7 (13%). Serum and liver PFOS increased with dose.

Calculations of Internal Dosimetric: TWA serum PFOS concentrations corresponding to external doses and exposure durations were predicted from a pharmacokinetic model (Wambaugh et al. 2013) using animal species-, strain-, and sex-specific parameters (see MRL approach section for details).

Human Equivalent Dose: HEDs were calculated based on the assumption that humans would have similar effects as the laboratory animal at a given serum concentration. HEDs that would result in steady-state serum concentrations of PFOS equal to the serum concentration selected as the POD were calculated using the first order single-compartment model (see MRL approach section for details).

Uncertainty Factor and Modifying Factor: The $NOAEL_{HED}$ is divided by a total uncertainty factor (UF) of 30 and modifying factor (MF) of 10:

- 3 UF for extrapolation from animals to humans with dosimetric adjustment
- 10 UF for human variability
- 10 MF for concern that immunotoxicity may be a more sensitive endpoint of PFOS toxicity than developmental toxicity

APPENDIX A

$$\text{Provisional MRL} = \text{NOAEL}_{\text{HED}} \div (\text{UFs} \times \text{MF})$$

$$0.000515 \text{ mg/kg/day} \div ((3 \times 10) \times 10) = 2 \times 10^{-6} \text{ mg/kg/day}$$

Although pharmacokinetic model parameters were not available for the strain/sex of the animals tested in the immunotoxicity studies, most of the studies did provide measured serum PFOS levels. The serum PFOS levels at the NOAEL and LOAEL doses are presented in Table A-17. The measured serum PFOS levels associated with altered immune responses are approximately 1–10 times lower than the serum concentration predicted to occur at the NOAEL dose. These data suggest that immunotoxicity may be a more sensitive effect than developmental toxicity.

Table A-17. Measured Serum PFOS Levels at the NOAEL and LOAEL Doses for Immunological Effects

Effect, species and exposure duration	Dose (mg/kg/day)	Measured mean serum PFOS (µg/mL)	Reference
Impaired response to sRBC in mice exposed for 60 days	NOAEL	0.0083	Dong et al. 2009
	LOAEL	0.083	
Impaired response to sRBC in mice exposed for 60 days	NOAEL	0.0167	Dong et al. 2011
	LOAEL	0.083	
Decreased resistance to influenza virus in mice exposed for 21 days	NOAEL	0.005	Guruge et al. 2009
	LOAEL	0.025	
Suppressed response to sRBC in mice exposed for 28 days	NOAEL	0.00016	Peden-Adams et al. 2008
	LOAEL	0.00166	

PFOS = perfluorooctane sulfonic acid; sRBC = sheep red blood cell

A candidate MRL was calculated using the NOAEL of 0.0167 mg/kg/day identified in the Dong et al. (2011). This study was selected over the other immunotoxicity studies because it identified the highest NOAEL for immunotoxicity and it had the longest exposure duration; the Peden-Adams et al. (2008) was not selected because the LOAEL of 0.00166 mg/kg/day is not supported by the other three studies. A TWA concentration was estimated using a similar approach described for PFHxS and PFNA in the MRL approach section. The estimated TWA concentration was 1.2 µg/mL for the 0.0167 mg/kg/day; this estimated TWA concentration was used to calculate a HED of 0.000083 mg/kg/day. A candidate MRL of 3×10^{-6} was calculated using an uncertainty factor of 30 (3 for extrapolation from animals to humans using dosimetric adjustments and 10 for human variability). This MRL is similar to the MRL calculated from the Luebker et al. (2005a) study and lends to support to using the additional uncertainty factor of 10 to account for the lack of pharmacokinetic modeling parameters for the mouse strains tested for immunotoxicity.

Other Additional Studies or Pertinent Information that Lend Support to this MRL: A discussion of the findings from epidemiology studies is presented in the MRL introduction section.

Agency Contacts (Chemical Managers): Selene Chou

APPENDIX A

MINIMAL RISK LEVEL (MRL) WORKSHEET

Chemical Name: Perfluorooctane sulfonic acid (PFOS)
CAS Numbers: 1763-23-1
Date: June 2018
Profile Status: Final, Pre-Public Comment
Route: Oral
Duration: Chronic

MRL Summary: There are insufficient data for derivation of a chronic-duration oral MRL for PFOS.

Rationale for Not Deriving an MRL: Immune function was not examined following chronic-duration oral exposure in laboratory animal studies; in intermediate-duration animal studies, the lowest LOAEL doses were for immunological effects. Given the concern that immunotoxicity may occur at lower doses than liver toxicity, a chronic-duration oral MRL for PFOS is not recommended at this time.

One study has evaluated the chronic toxicity of PFOS in laboratory animals. Histological alterations in the liver were the primary effects observed in rats exposed to PFOS in the diet for 2 years (Butenhoff et al. 2012b; Thomford 2002b). Centrilobular hepatocellular hypertrophy was observed in rats exposed to ≥ 0.1 mg/kg/day. At 1.04 mg/kg/day, increases in the incidence of single cell necrosis and cystic degeneration were observed in the liver. Decreases in body weight were observed at 1.04 mg/kg/day in female rats. Thus, the 1.04 mg/kg/day dose was identified as the lowest LOAEL for this study. Epidemiology data (Dalsager et al. 2016; Dong et al. 2013; Fei et al. 2010; Grandjean et al. 2012, 2016; Granum et al. 2013; Kielsen et al. 2016; Mogensen et al. 2015a; Stein et al. 2016a; Zhu et al. 2016) suggest that the immune system is a sensitive target of PFOS toxicity following long-term exposures, which is supported by intermediate-duration PFOS laboratory animal studies (Dong et al. 2009, 2011; Guruge et al. 2009; Peden-Adams et al. 2008).

Agency Contacts (Chemical Managers): Selene Chou

APPENDIX A

MINIMAL RISK LEVEL (MRL) WORKSHEET

Chemical Name: Perfluorohexane sulfonic acid (PFHxS)
CAS Numbers: 355-46-4
Date: June 2018
Profile Status: Final, Pre-Public Comment
Route: Inhalation
Duration: Acute

MRL Summary: There are insufficient data for derivation of an acute-duration inhalation MRL for PFHxS.

Rationale for Not Deriving an MRL: No inhalation studies in laboratory animals were identified for PFHxS.

Agency Contacts (Chemical Managers): Selene Chou

APPENDIX A

MINIMAL RISK LEVEL (MRL) WORKSHEET

Chemical Name: Perfluorohexane sulfonic acid (PFHxS)
CAS Numbers: 355-46-4
Date: June 2018
Profile Status: Final, Pre-Public Comment
Route: Inhalation
Duration: Intermediate

MRL Summary: There are insufficient data for derivation of an intermediate-duration inhalation MRL for PFHxS.

Rationale for Not Deriving an MRL: No inhalation studies in laboratory animals were identified for PFHxS.

Agency Contacts (Chemical Managers): Selene Chou

APPENDIX A

MINIMAL RISK LEVEL (MRL) WORKSHEET

Chemical Name: Perfluorohexane sulfonic acid (PFHxS)
CAS Numbers: 355-46-4
Date: June 2018
Profile Status: Final, Pre-Public Comment
Route: Inhalation
Duration: Chronic

MRL Summary: There are insufficient data for derivation of a chronic-duration inhalation MRL for PFHxS.

Rationale for Not Deriving an MRL: No inhalation studies in laboratory animals were identified for PFHxS.

Agency Contacts (Chemical Managers): Selene Chou

APPENDIX A

MINIMAL RISK LEVEL (MRL) WORKSHEET

Chemical Name: Perfluorohexane sulfonic acid (PFHxS)
CAS Numbers: 355-46-4
Date: June 2018
Profile Status: Final, Pre-Public Comment
Route: Oral
Duration: Acute

MRL Summary: There are insufficient data for derivation of an acute-duration oral MRL for PFHxS.

Rationale for Not Deriving an MRL: The acute oral database for PFHxS was not considered adequate for derivation of an MRL due to the short duration of the only available study and the lack of pharmacokinetic model parameters for calculating an HED.

In the only available study of PFHxS in laboratory animals, Viberg et al. (2013) reported altered spontaneous behavior and habituation in adult mice administered a single gavage dose of 9.2 mg/kg/day PFHxS on PND 10; no alterations were observed at 6.1 mg/kg/day. This single exposure study was not considered adequate as the basis of an acute-duration MRL for PFHxS due to the uncertainty of whether an MRL based on this study would be protective for repeated exposures or for other potential sensitive endpoints, such as immunotoxicity.

For perfluoroalkyls, ATSDR has used the approach of predicting TWA serum perfluoroalkyl levels in laboratory animals and calculating HEDs for these serum concentrations. For PFOA and PFOS, the Wambaugh et al. (2013) pharmacokinetic model was utilized for predicting the TWA serum perfluoroalkyl concentrations. However, strain-, sex-, and compound-specific model parameters are not available for other perfluoroalkyls, thus precluding deriving MRLs for other perfluoroalkyls. Other approaches such as “read across” (i.e., using data for a particular endpoint from one chemical to predict the same endpoint for another chemical that has similar chemical structure or mechanisms of action) or equivalency factors were considered for the other perfluoroalkyl compounds; however, there are limited data available that would allow for comparison of the toxicity and toxicokinetic properties of different perfluoroalkyl compounds. Peters and Gonzalez (2011) noted that the toxic equivalency factor approach would not be suitable for perfluoroalkyls because the current data suggest that the toxicity of these compounds appear to be mediated by multiple receptors, including PPAR α , CAR, and PXR, and that there may be species differences in the response mediated by different receptors. Additionally, available data suggest that there are qualitative differences in the toxicities of various perfluoroalkyls.

Agency Contacts (Chemical Managers): Selene Chou

APPENDIX A

MINIMAL RISK LEVEL (MRL) WORKSHEET

Chemical Name: Perfluorohexane sulfonic acid (PFHxS)
CAS Numbers: 355-46-4
Date: June 2018
Profile Status: Final, Pre-Public Comment
Route: Oral
Duration: Intermediate
Provisional MRL: 2×10^{-5} mg/kg/day
Critical Effect: Thyroid follicular cell damage
Reference: Butenhoff et al. 2009a; Hoberman and York 2003
Point of Departure: 0.0047 mg/kg/day
Uncertainty Factor: 30
Modifying Factor: 10
LSE Graph Key: 32
Species: Rat

MRL Summary: A provisional intermediate-duration oral MRL of 2×10^{-5} mg/kg/day was derived for PFHxS based on thyroid follicular cell damage in adult male rats administered via gavage PFHxS for a minimum of 42 days (Butenhoff et al. 2009a; Hoberman and York 2003). The MRL is based on a HED NOAEL of 0.0047 mg/kg/day and a total uncertainty factor of 30 (3 for extrapolation from animals to humans with dosimetric adjustments and 10 for human variability) and a modifying factor of 10 for database limitations.

Selection of the Critical Effect: Two intermediate-duration studies in laboratory animals have been identified for PFHxS. In a developmental toxicity study, increased incidences of thyroid follicular cells hypertrophy, and hyperplasia were observed in F0 male rats administered ≥ 3 mg/kg/day (Butenhoff et al. 2009a; Hoberman and York 2003). Increased liver weight and centrilobular hepatocellular hypertrophy were also observed in the males at ≥ 3 mg/kg/day. No reproductive or developmental effects were reported. Liver effects (decreases in serum lipids, increases in hepatic triglyceride levels, and increases in liver weight) were also observed in mice exposed to 6 mg/kg/day PFHxS in the diet for 4–6 weeks (Bijland et al. 2011). Using the Hall et al. (2012) criteria (see Section 2.9 for a discussion of the criteria), the liver effects were not considered relevant for human risk assessment. Thus, the lowest LOAEL identified in intermediate-duration studies was 3 mg/kg/day for thyroid effects.

Selection of the Principal Study: Since the liver effects were not considered relevant to humans, the Butenhoff et al. (2009a) study was selected as the principal study. Thyroid effects in male rats was noted as the most sensitive endpoint in this study, with a LOAEL of 3 mg/kg/day and a NOAEL of 1 mg/kg/day.

Summary of the Principal Study:

Butenhoff JL, Chang SC, Ehresman DJ, et al. 2009a. Evaluation of potential reproductive and developmental toxicity of potassium perfluorohexanesulfonate in Sprague Dawley rats. *Reprod Toxicol* 27:331-341.

Hoberman AM, York RG. 2003. Oral (gavage) combined repeated dose toxicity study of T-7706 with the reproduction/developmental toxicity screening test. Argus Research.

APPENDIX A

The reproductive/developmental effects of PFHxS were studied in Sprague-Dawley rats (15/sex/group). Doses of 0, 0.3, 1, 3, or 10 mg/kg/day PFHxS were administered by gavage in an aqueous vehicle. Male rats were dosed beginning 14 days before cohabitation and continued until 1 day before sacrifice (a minimum of 42 days). Females were dosed beginning 14 days before cohabitation and continued until 1 day before sacrifice on PND 21 or GD 25 (rats that did not deliver a litter). Endpoints evaluated included: body weight, food consumption, estrous cycling, functional observational battery (FOB; tests of autonomic function, reactivity and sensitivity, excitability, gait and sensorimotor coordination, grip strength, and clinical signs), hematology and clinical chemistry, gross necropsy, organ weights, histopathology, and sperm evaluations. At parturition, litters were evaluated for size and viability; weight of the pups was also recorded. Pups were sacrificed on PND 22.

The following are findings for male F0 rats. Treatment with PFHxS did not affect survival and did not induce clinical signs that could be attributed to the chemical. Terminal body weight in the 10 mg/kg/day groups was approximately 6% lower than controls. Food consumption was not affected. Necropsy did not reveal any treatment-related changes. Histopathological effects were restricted to the liver and thyroid of males treated with 3 and 10 mg/kg/day. Liver effects consisted of minimal to moderate hypertrophy of centrilobular hepatocytes. The affected hepatocytes were enlarged with an increased amount of dense eosinophilic granular cytoplasm. In the thyroid, the changes consisted of hypertrophy and hyperplasia of follicular cells. These effects could have been associated with the liver effects.

Significant organ weight changes consisted of increased absolute and relative liver weight at 3 and 10 mg/kg/day and decreased heart/brain weight at 10 mg/kg/day. Significant hematology changes consisted of decreased hemoglobin at 1 mg/kg/day, decreased red cell count and hematocrit at 3 mg/kg/day, and increased prothrombin time at 0.3 mg/kg/day. Increases in albumin, BUN, alkaline phosphatase, calcium, and albumin/globulin ratio were seen at 10 mg/kg/day. There were no significant effects on the FOB or on motor activity and no significant effects on sperm parameters. There were no significant effects in any parameter monitored in F0 females or in pups. Treatment with PFHxS had no significant effect on the gross or microscopic morphology of the spleen, thymus, or lymph nodes. There were no significant effects on sex organ weights or gross or microscopic lesions in the reproductive organs of males and females. Fertility was not affected by treatment with PFHxS and there were no significant effects on sperm parameters. Estrous cycling was not affected by dosing with PFHxS. Treatment with PFHxS did not significantly affect any of the developmental parameters evaluated including gestation length, number of dams delivering litters, averages for implantation sites per delivered litter, number of dams with stillborn pups, number of dams with no live pups, dams with all pups dying, number of pups surviving per litter, sex ratios, litter size, or pup weight. Also, necropsy of the pups showed no treatment-related effects, and pup liver weight was not affected. Treatment with PFHxS had no significant effect on the FOB or motor activity. The battery tested autonomic functions, reactivity and sensitivity to stimuli, excitability, gait and sensorimotor coordination, limb grip strength, and abnormal clinical signs.

Selection of the Point of Departure for the MRL: The HED of the NOAEL of 1 mg/kg/day identified in the Butenhoff et al. (2009a) developmental toxicity study was selected as the POD for the MRL. A TWA serum PFHxS concentration of 73.22 µg/mL was estimated for the adult males exposed to 1 mg/kg/day (Butenhoff et al. 2009a).

Human Equivalent Dose: HEDs were calculated based on the assumption that humans would have similar effects as the laboratory animal at a given serum concentration. HEDs that would result in steady-state serum concentrations of PFHxS equal to the estimated TWA serum concentration selected as the POD were calculated using the first-order single-compartment model (see MRL approach section for details). The PFHxS model parameters for humans are presented in Table A-4. The NOAEL_{HED} is 0.0047 mg/kg/day

APPENDIX A

Uncertainty Factor and Modifying Factor: The NOAEL_{HED} is divided by a total uncertainty factor (UF) of 30 and a modifying factor (MF) of 10:

- 3 UF for extrapolation from animals to humans with dosimetric adjustment
- 10 UF for human variability
- 10 MF for database limitations to account for small number of studies examining the toxicity of PFHxS following intermediate-duration exposure and the limited scope of these studies in particular studies examining immunotoxicity, a sensitive endpoint for other perfluoroalkyl compounds, and general toxicity.

$$\begin{aligned} \text{Provisional MRL} &= \text{NOAEL}_{\text{HED}} \div (\text{UFs} \times \text{MF}) \\ 0.0047 \text{ mg/kg/day} &\div ((10 \times 3) \times 10) = 2 \times 10^{-5} \text{ mg/kg/day} \end{aligned}$$

Other Additional Studies or Pertinent Information that Lend Support to this MRL: A discussion of the findings from epidemiology studies is presented in the MRL introduction section.

Agency Contacts (Chemical Managers): Selene Chou

APPENDIX A

MINIMAL RISK LEVEL (MRL) WORKSHEET

Chemical Name: Perfluorohexane sulfonic acid (PFHxS)
CAS Numbers: 355-46-4
Date: June 2018
Profile Status: Final, Pre-Public Comment
Route: Oral
Duration: Chronic

MRL Summary: There are insufficient data for derivation of a chronic-duration oral MRL for PFHxS.

Rationale for Not Deriving an MRL: No chronic-duration oral studies in laboratory animals were identified for PFHxS.

Agency Contacts (Chemical Managers): Selene Chou

APPENDIX A

MINIMAL RISK LEVEL (MRL) WORKSHEET

Chemical Name: Perfluorononanoic acid (PFNA)
CAS Numbers: 375-95-1
Date: June 2018
Profile Status: Final, Pre-Public Comment
Route: Inhalation
Duration: Acute

MRL Summary: There are insufficient data for derivation of an acute-duration inhalation MRL for PFNA.

Rationale for Not Deriving an MRL: The only available inhalation exposure study for PFNA (Kinney et al. 1989) was not considered suitable for derivation of an inhalation MRL due to its lack of histopathological examination and short exposure duration.

In the only available inhalation exposure study for PFNA, Kinney et al. (1989) noted labored breathing in rats during and after a 4-hour nose-only exposure to 590 mg/m³ exposure; the study also reported an increase in relative liver weight 5 days after exposure to ≥ 67 mg/m³.

Agency Contacts (Chemical Managers): Selene Chou

APPENDIX A

MINIMAL RISK LEVEL (MRL) WORKSHEET

Chemical Name: Perfluorononanoic acid (PFNA)
CAS Numbers: 375-95-1
Date: June 2018
Profile Status: Final, Pre-Public Comment
Route: Inhalation
Duration: Intermediate

MRL Summary: There are insufficient data for derivation of an intermediate-duration inhalation MRL for PFNA.

Rationale for Not Deriving an MRL: No intermediate-duration inhalation studies in laboratory animals were identified for PFNA.

Agency Contacts (Chemical Managers): Selene Chou

APPENDIX A

MINIMAL RISK LEVEL (MRL) WORKSHEET

Chemical Name: Perfluorononanoic acid (PFNA)
CAS Numbers: 375-95-1
Date: June 2018
Profile Status: Final, Pre-Public Comment
Route: Inhalation
Duration: Chronic

MRL Summary: There are insufficient data for derivation of a chronic-duration inhalation MRL for PFNA.

Rationale for Not Deriving an MRL: No chronic-duration inhalation studies in laboratory animals were identified for PFNA.

Agency Contacts (Chemical Managers): Selene Chou

APPENDIX A

MINIMAL RISK LEVEL (MRL) WORKSHEET

Chemical Name: Perfluorononanoic acid (PFNA)
CAS Numbers: 375-95-1
Date: June 2018
Profile Status: Final, Pre-Public Comment
Route: Oral
Duration: Acute

MRL Summary: There are insufficient data for derivation of an acute-duration oral MRL for PFNA.

Rationale for Not Deriving an MRL: An acute-duration oral MRL cannot be derived for PFNA because the study identifying the lowest dose for a non-hepatic effect (Fang et al. 2009) did not measure serum PFNA levels, which are needed for estimating an HED.

A number of studies examined the toxicity of PFNA in rats and mice exposed for acute durations. These studies reported immune, liver, and body weight effects. Immune effects included increases in thymus weight in rats at 1 mg/kg/day (Fang et al. 2009), decreases in thymus and spleen weights in rats at 3 mg/kg/day (Fang et al. 2009, 2010), and an alteration in splenic lymphocyte phenotypes in mice at 1 mg/kg/day (Fang et al. 2008). In the only study examining immune function, no alterations in splenic lymphocyte response to ConA were observed at doses as high as 5 mg/kg/day in mice (Fang et al. 2008). Liver effects included increases in hepatic lipid levels at ≥ 0.2 mg/kg/day (Wang et al. 2015a), increases in liver weights at ≥ 0.2 mg/kg/day (Wang et al. 2015a; Kennedy 1987), serum lipid levels at ≥ 1 mg/kg/day (Fang et al. 2012a, 2012b), hepatocellular vacuolation at 5 mg/kg/day (Fang et al. 2012b), and increases in serum aminotransferases at 5 mg/kg/day (Wang et al. 2015a). Decreases in body weight were observed in rats and mice administered 5 mg/kg/day (Hadrup et al. 2016; Wang et al. 2015a).

Agency Contacts (Chemical Managers): Selene Chou

APPENDIX A

MINIMAL RISK LEVEL (MRL) WORKSHEET

Chemical Name:	Perfluorononanoic acid (PFNA)
CAS Numbers:	375-95-1
Date:	June 2018
Profile Status:	Final, Pre-Public Comment
Route:	Oral
Duration:	Intermediate
Provisional MRL:	3×10^{-6} mg/kg/day
Critical Effect:	Decreased body weight and developmental delays
Reference:	Das et al. 2015
Point of Departure:	0.001 mg/kg/day
Uncertainty Factor:	30
Modifying Factor:	10
LSE Graph Key:	35
Species:	Mouse

MRL Summary: A provisional intermediate-duration oral MRL of 3×10^{-6} mg/kg/day was derived for PFNA based on decreased body weight gain and developmental delays in the offspring of mice administered via gavage PFNA on GDs 1–17 (Das et al. 2015). The MRL is based on a HED NOAEL of 0.001 mg/kg/day and a total uncertainty factor of 30 (3 for extrapolation from animals to humans with dosimetric adjustments and 10 for human variability), and a modifying factor of 10 for database limitations.

Selection of the Critical Effect: The intermediate-duration database consists of three developmental toxicity studies in rats and mice. The lowest LOAEL for developmental toxicity was 1.1 mg/kg/day in mice administered PFNA on GDs 1–18; at this dose, decreases in litter size and pup survival were observed (Wolf et al. 2010). At higher doses (2–5 mg/kg/day), decreases in pup body weight, delays in postnatal development (Das et al. 2015; Rogers et al. 2014; Wolf et al. 2010), increases in pup systolic blood pressure (Rogers et al. 2014), and reduced nephron endowment (Rogers et al. 2014) were observed. A study of PPAR α knockout mice did not find alterations pup body weight or postnatal development at 2 mg/kg/day (Wolf et al. 2010). A summary of developmental effects is presented in Table A-18.

Table A-18. Summary of the Adverse Effects Observed in Laboratory Animals Following Intermediate-Duration Oral Exposure to PFNA

Species and exposure duration	Dose (mg/kg/day)	Effect	Reference
129S1/sv1m mouse GDs 1–18 (offspring followed until PND 21)	0.83	No effects reported	Wolf et al. 2010
	1.1	Decreased litter size and pup survival	
	1.5	No effects reported	
	2.0	Decreased number of live pups per litter and decreased pup body weight gain	
CD-1 mouse GDs 1–17 (offspring followed until PND 287)	1	No effects reported	Das et al. 2015
	3	Decreased body weight gain and delayed eye opening, preputial separation, and vaginal opening	

APPENDIX A

Table A-18. Summary of the Adverse Effects Observed in Laboratory Animals Following Intermediate-Duration Oral Exposure to PFNA

Species and exposure duration	Dose (mg/kg/day)	Effect	Reference
	5	Decreased postnatal survival, 80% mortality between PND 2 and 10	
	10	Full litter resorption	
Sprague-Dawley rat GDs 1–20 (offspring followed through PND 434)	5	Decreased birth weight, increased blood pressure at 10 weeks of age; reduced nephron endowment	Rogers et al. 2014

GD = gestation day; PFNA perfluorononanoic acid; PND = postnatal day

Selection of the Principal Study: Developmental toxicity, including decreases in pup survival, developmental delays, and decreases in birth weight have been observed in three studies. A comparison of the estimated TWA serum PFNA levels (Table A-19) for the Wolf et al. (2010) and Das et al. (2015) studies (measured serum levels were not available from the Rogers et al. 2014 study) showed that the lowest LOAEL for developmental effects was 10.9 µg/mL (Das et al. 2015); this study reported a NOAEL of 6.8 µg/mL. Thus, the Das et al. (2015) study was selected as the principal study for the MRL.

Table A-19. Summary of Estimated TWA Serum PFNA levels in Laboratory Animals Following Intermediate-Duration Oral Exposure

Species and exposure duration	Dose (mg/kg/day)	Estimated TWA serum PFNA (µg/mL)	Effect	Reference
129S1/sv1m mouse GDs 1–18 (offspring followed until PND 21)	0.83	4.47	No effects reported	Wolf et al. 2010
	1.1	11.6	Decreased litter size and pup survival	
	1.5	10.5	No effects reported	
	2.0	17.6	Decreased number of live pups per litter and decreased pup body weight gain	
CD-1 mouse GDs 1–17 (offspring followed until PND 287)	1	6.8	No effects reported	Das et al. 2015
	3	10.9	Decreased body weight gain and delayed eye opening, preputial separation, and vaginal opening	
	5	39.7	Decreased postnatal survival, 80% mortality between PND 2 and 10	
	10	NA	Full litter resorption	
Sprague-Dawley rat GDs 1–20 (offspring followed through PND 434)	5	Not calculated	Decreased birth weight, increased blood pressure at 10 weeks of age; reduced nephron endowment	Rogers et al. 2014

GD = gestation day; PFNA perfluorononanoic acid; PND = postnatal day

APPENDIX A

Summary of the Principal Study:

Das KP, Grey BE, Rosen MB, Wood CR, Tatum-Gibbs KR, Zehr RD, Strynar MJ, Lindstrom AB, Lau C. 2015. Developmental toxicity of perfluorononanoic acid in mice. *Reprod Toxicol.* 51:133-44.

Groups of 8–10 timed-pregnant female CD-1 mice were administered via gavage 1, 3, 5, or 10 mg/kg/day PFNA at a dosing volume of 10 ml/kg body weight in deionized water on GDs 1–17. On GD 17, selected mice from each group were sacrificed for maternal and fetal examination, while the remaining mice were allowed to give birth. Pups were observed for postnatal survival up to PND 24 as well as growth and development up to PND 287. The following parameters were used to assess toxicity: clinical observations, maternal body weight, pup body weight (pre- and postnatal), organ weights (liver, gravid uterus weight), number of implantation sites, percent of live fetuses, percent of prenatal loss per litter, and morphological changes (eye opening, vaginal opening, preputial separation).

Maternal weight loss beginning on GD 8 was observed at 10 mg/kg/day; on GD 13, the 10 mg/kg/day group weighed approximately 30% less than controls. The 10 mg/kg/day group was terminated on GD 13. Significant increases in full litter resorptions occurred at 10 mg/kg/day (7/7 compared to 2/8 in controls). There were no adverse effects on pregnancy outcome following *in utero* exposure to 5 mg/kg. Statistically significant dose-related increases in absolute and relative liver weights were observed in dams in the 1, 3, and 5 mg/kg/day groups examined on GD 17, as well as in dams examined on post-weaning day 28. There were no effects on the number of implants, number of live fetuses, or fetal body weight. Relative and absolute fetal liver weight were significantly increased; however, the increase did not appear to be dose-related. Visceral and skeletal examination of fetuses revealed no treatment-related effects. Increases in postnatal deaths were observed in the 5 mg/kg/day offspring between PND 2 and 10; postnatal survival was approximately 20% on PND 10. Weight gain was significantly reduced in male pups from the 3 and 5 mg/kg dose groups and in females from the 5 mg/kg dose group. The changes in males were dose-related and persisted from PND 25 to 287. Weight reduction in females was less substantial in comparison with males and returned to control levels by 7 weeks of age. Relative pup liver weights were significantly increased at all doses up to PND 24 and at 3 and 5 mg/kg/day on PND 42. No significant effects on liver weight were detectable by PND 70. Postnatal development (eye opening, preputial separation, and vaginal opening) was significantly delayed (by 2–7 days) at 3 and 5 mg/kg/day.

Selection of the Point of Departure for the MRL: The HED of the NOAEL of 1 mg/kg/day identified in the Das et al. (2015) developmental toxicity study was selected as the POD for the MRL. A TWA serum PFNA concentration was estimated for dams using the serum concentration in the control group (0.015 µg/mL) as the baseline concentrations and the terminal concentration for the 1 mg/kg/day group (13.67 µg/mL) resulting in an estimated TWA serum concentration of 6.8 µg/mL (serum concentrations were provided to ATSDR).

Human Equivalent Dose: HEDs were calculated based on the assumption that humans would have similar effects as the laboratory animal at a given serum concentration. HEDs that would result in steady-state serum concentrations of PFNA equal to the estimated TWA serum concentration selected as the POD were calculated using the first-order single-compartment model (see MRL approach section for details). The PFNA model parameters for humans are presented in Table A-4. The NOAEL_{HED} is 0.001 mg/kg/day

Uncertainty Factor and Modifying Factor: The NOAEL_{HED} is divided by a total uncertainty factor (UF) of 30 and modifying factor (MF) of 10:

- 3 UF for extrapolation from animals to humans with dosimetric adjustment
- 10 UF for human variability

APPENDIX A

- 10 MF for database limitations to account for small number of studies examining the toxicity of PFNA following intermediate-duration exposure and the limited scope of these studies. In particular, no studies were identified that examined immunotoxicity, a sensitive endpoint for other perfluoroalkyl compounds, or general toxicity.

$$\text{Provisional MRL} = \text{NOAEL}_{\text{HED}} \div (\text{UFs} \times \text{MF})$$

$$0.001 \text{ mg/kg/day} \div ((10 \times 3) \times 10) = 3 \times 10^{-6} \text{ mg/kg/day}$$

Other Additional Studies or Pertinent Information that Lend Support to this MRL: A discussion of the findings from epidemiology studies is presented in the MRL introduction section.

Agency Contacts (Chemical Managers): Selene Chou

APPENDIX A

MINIMAL RISK LEVEL (MRL) WORKSHEET

Chemical Name: Perfluorononanoic acid (PFNA)
CAS Numbers: 375-95-1
Date: June 2018
Profile Status: Final, Pre-Public Comment
Route: Oral
Duration: Chronic

MRL Summary: There are insufficient data for derivation of a chronic-duration oral MRL for PFNA.

Rationale for Not Deriving an MRL: No chronic-duration oral studies in laboratory animals were identified for PFNA.

Agency Contacts (Chemical Managers): Selene Chou

APPENDIX A

MINIMAL RISK LEVEL (MRL) WORKSHEET

Chemical Name: Perfluorodecanoic acid (PFDeA)
CAS Numbers: 335-76-2
Date: June 2018
Profile Status: Final, Pre-Public Comment
Route: Inhalation
Duration: Acute

MRL Summary: There are insufficient data for derivation of an acute-duration inhalation MRL for PFDeA.

Rationale for Not Deriving an MRL: No inhalation studies in laboratory animals were identified for PFDeA.

Agency Contacts (Chemical Managers): Selene Chou

APPENDIX A

MINIMAL RISK LEVEL (MRL) WORKSHEET

Chemical Name: Perfluorodecanoic acid (PFDeA)
CAS Numbers: 335-76-2
Date: June 2018
Profile Status: Final, Pre-Public Comment
Route: Inhalation
Duration: Intermediate

MRL Summary: There are insufficient data for derivation of an intermediate-duration inhalation MRL for PFDeA.

Rationale for Not Deriving an MRL: No inhalation studies in laboratory animals were identified for PFDeA.

Agency Contacts (Chemical Managers): Selene Chou

APPENDIX A

MINIMAL RISK LEVEL (MRL) WORKSHEET

Chemical Name: Perfluorodecanoic acid (PFDeA)
CAS Numbers: 335-76-2
Date: June 2018
Profile Status: Final, Pre-Public Comment
Route: Inhalation
Duration: Chronic

MRL Summary: There are insufficient data for derivation of a chronic-duration inhalation MRL for PFDeA.

Rationale for Not Deriving an MRL: No inhalation studies in laboratory animals were identified for PFDeA.

Agency Contacts (Chemical Managers): Selene Chou

MINIMAL RISK LEVEL (MRL) WORKSHEET

Chemical Name: Perfluorodecanoic acid (PFDeA)
CAS Numbers: 335-76-2
Date: June 2018
Profile Status: Final, Pre-Public Comment
Route: Oral
Duration: Acute

MRL Summary: There are insufficient data for derivation of an acute-duration oral MRL for PFDeA.

Rationale for Not Deriving an MRL: The available acute oral database for PFDeA was not considered adequate for derivation of an MRL because the study identifying the lowest adverse effect level did not measure serum PFDeA levels, which are needed to estimate HEDs.

Several laboratory animal studies have examined the acute oral toxicity of PFDeA; most were limited in scope. The lowest LOAEL was 1 mg/kg/day for decreases in fetal weight in mice administered PFDeA on GDs 6–15 (Harris and Birnbaum 1989). At 12.8 mg/kg/day, decreases in the number of live fetuses per litter were observed; maternal weight loss was also observed at this dose level (Harris and Birnbaum 1989). Another developmental toxicity study did not report alterations in performance on neurobehavioral tests in 2–4-month-old mice administered 10.8 mg/kg/day PFDeA on PND 10 (Johansson et al. 2008). Other effects observed in acute exposure studies include decreases in maternal weight gain at 6.4 mg/kg/day (Harris and Birnbaum 1989), weight loss at ≥ 9.5 mg/kg/day in rats (Kawashima et al. 1995) and mice (Harris and Birnbaum 1989; Permadi et al. 1992, 1993), increases in T3 and T4 levels in mice at 80 mg/kg/day (Harris et al. 1989), decreases in spleen weight in mice at 80 mg/kg/day (Harris et al. 1989), and atrophy and lymphoid depletion in thymus and spleen in mice at 160 mg/kg/day (Harris et al. 1989). Liver effects included increases in liver weight at ≥ 2.4 mg/kg/day (Brewster and Birnbaum 1989; Harris et al. 1989; Kawashima et al. 1995; Permadi et al. 1992, 1993), increases in hepatic lipid levels at ≥ 9.5 mg/kg/day (Brewster and Birnbaum 1989; Kawashima et al. 1995), and hepatocellular hypertrophy at ≥ 20 mg/kg/day (Harris et al. 1989).

To derive MRLs for perfluoroalkyls, ATSDR used the approach of predicting TWA serum perfluoroalkyl levels in laboratory animals or measured serum perfluoroalkyl levels and calculating HEDs for these serum concentrations. For PFOA and PFOS, the Wambaugh et al. (2013) pharmacokinetic model was utilized for predicting the TWA serum perfluoroalkyl concentrations. However, strain-, sex-, and compound-specific model parameters are not available for other perfluoroalkyls. The Harris and Birnbaum (1989) study, which identified the lowest adverse effect level, did not measure maternal serum PFDeA levels. Thus, HEDs could not be calculated using animal serum PFDeA levels. Other approaches such as “read across” or equivalency factors were considered; however, there are limited data available that would allow for comparison of the toxicity and toxicokinetic properties of different perfluoroalkyl compounds. Peters and Gonzalez (2011) noted that the toxic equivalency factor approach would not be suitable for perfluoroalkyls because the current data suggest that the toxicity of these compounds appear to be mediated by multiple receptors, including PPAR α , CAR, and PXR, and that there may be species differences in the response mediated by different receptors. Additionally, available data suggest that there are qualitative differences in the toxicities of various perfluoroalkyls.

Agency Contacts (Chemical Managers): Selene Chou

APPENDIX A

MINIMAL RISK LEVEL (MRL) WORKSHEET

Chemical Name: Perfluorodecanoic acid (PFDeA)
CAS Numbers: 335-76-2
Date: June 2018
Profile Status: Final, Pre-Public Comment
Route: Oral
Duration: Intermediate

MRL Summary: There are insufficient data for derivation of an intermediate-duration oral MRL for PFDeA.

Rationale for Not Deriving an MRL: No intermediate-duration oral studies in laboratory animals were identified for PFDeA.

Agency Contacts (Chemical Managers): Selene Chou

APPENDIX A

MINIMAL RISK LEVEL (MRL) WORKSHEET

Chemical Name: Perfluorodecanoic acid (PFDeA)
CAS Numbers: 335-76-2
Date: June 2018
Profile Status: Final, Pre-Public Comment
Route: Oral
Duration: Chronic

MRL Summary: There are insufficient data for derivation of a chronic-duration oral MRL for PFDeA.

Rationale for Not Deriving an MRL: No chronic-duration oral studies in laboratory animals were identified for PFDeA.

Agency Contacts (Chemical Managers): Selene Chou

APPENDIX A

MINIMAL RISK LEVEL (MRL) WORKSHEET

Chemical Name: Perfluoroundecanoic acid (PFUA)
CAS Numbers: 2058-94-8
Date: June 2018
Profile Status: Final, Pre-Public Comment
Route: Inhalation
Duration: Acute

MRL Summary: There are insufficient data for derivation of an acute-duration inhalation MRL for PFUA.

Rationale for Not Deriving an MRL: No inhalation studies in laboratory animals were identified for PFUA.

Agency Contacts (Chemical Managers): Selene Chou

APPENDIX A

MINIMAL RISK LEVEL (MRL) WORKSHEET

Chemical Name: Perfluoroundecanoic acid (PFUA)
CAS Numbers: 2058-94-8
Date: June 2018
Profile Status: Final, Pre-Public Comment
Route: Inhalation
Duration: Intermediate

MRL Summary: There are insufficient data for derivation of an intermediate-duration inhalation MRL for PFUA.

Rationale for Not Deriving an MRL: No inhalation studies in laboratory animals were identified for PFUA.

Agency Contacts (Chemical Managers): Selene Chou

APPENDIX A

MINIMAL RISK LEVEL (MRL) WORKSHEET

Chemical Name: Perfluoroundecanoic acid (PFUA)
CAS Numbers: 2058-94-8
Date: June 2018
Profile Status: Final, Pre-Public Comment
Route: Inhalation
Duration: Chronic

MRL Summary: There are insufficient data for derivation of a chronic-duration inhalation MRL for PFUA.

Rationale for Not Deriving an MRL: No inhalation studies in laboratory animals were identified for PFUA.

Agency Contacts (Chemical Managers): Selene Chou

APPENDIX A

MINIMAL RISK LEVEL (MRL) WORKSHEET

Chemical Name: Perfluoroundecanoic acid (PFUA)
CAS Numbers: 2058-94-8
Date: June 2018
Profile Status: Final, Pre-Public Comment
Route: Oral
Duration: Acute

MRL Summary: There are insufficient data for derivation of an acute-duration oral MRL for PFUA.

Rationale for Not Deriving an MRL: No acute-duration oral studies in laboratory animals were identified for PFUA.

Agency Contacts (Chemical Managers): Selene Chou

APPENDIX A

MINIMAL RISK LEVEL (MRL) WORKSHEET

Chemical Name: Perfluoroundecanoic acid (PFUA)
CAS Numbers: 2058-94-8
Date: June 2018
Profile Status: Final, Pre-Public Comment
Route: Oral
Duration: Intermediate

MRL Summary: There are insufficient data for derivation of an intermediate-duration oral MRL for PFUA.

Rationale for Not Deriving an MRL: Intermediate-duration oral database was considered inadequate for derivation of an MRL for PFUA because the only available study did not measure serum PFUA levels, which are needed to calculate HEDs (see MRL approach in Appendix A introduction).

One study was identified that examined the oral toxicity of PFUA in laboratory animals. In this study, decreases in body weight, hematological alterations, increases in liver weight, and centrilobular hypertrophy were observed in rat dams administered 1.0 mg/kg/day for 41–46 days (Takahashi et al. 2014). The study also found decreases in pup body weight on PNDs 0 and 4 at 1.0 mg/kg/day.

Agency Contacts (Chemical Managers): Selene Chou

APPENDIX A

MINIMAL RISK LEVEL (MRL) WORKSHEET

Chemical Name: Perfluoroundecanoic acid (PFUA)
CAS Numbers: 2058-94-8
Date: June 2018
Profile Status: Final, Pre-Public Comment
Route: Oral
Duration: Chronic

MRL Summary: There are insufficient data for derivation of a chronic-duration oral MRL for PFUA.

Rationale for Not Deriving an MRL: No chronic-duration oral studies in laboratory animals were identified for PFUA.

Agency Contacts (Chemical Managers): Selene Chou

APPENDIX A

MINIMAL RISK LEVEL (MRL) WORKSHEET

Chemical Name: Perfluoroheptanoic acid (PFHpA)
CAS Numbers: 375-85-9
Date: June 2018
Profile Status: Final, Pre-Public Comment
Route: Inhalation
Duration: Acute

MRL Summary: There are insufficient data for derivation of an acute-duration inhalation MRL for PFHpA.

Rationale for Not Deriving an MRL: No inhalation studies in laboratory animals were identified for PFHpA.

Agency Contacts (Chemical Managers): Selene Chou

APPENDIX A

MINIMAL RISK LEVEL (MRL) WORKSHEET

Chemical Name: Perfluoroheptanoic acid (PFHpA)
CAS Numbers: 375-85-9
Date: June 2018
Profile Status: Final, Pre-Public Comment
Route: Inhalation
Duration: Intermediate

MRL Summary: There are insufficient data for derivation of an intermediate-duration inhalation MRL for PFHpA.

Rationale for Not Deriving an MRL: No inhalation studies in laboratory animals were identified for PFHpA.

Agency Contacts (Chemical Managers): Selene Chou

APPENDIX A

MINIMAL RISK LEVEL (MRL) WORKSHEET

Chemical Name: Perfluoroheptanoic acid (PFHpA)
CAS Numbers: 375-85-9
Date: June 2018
Profile Status: Final, Pre-Public Comment
Route: Inhalation
Duration: Chronic

MRL Summary: There are insufficient data for derivation of a chronic-duration inhalation MRL for PFHpA.

Rationale for Not Deriving an MRL: No inhalation studies in laboratory animals were identified for PFHpA.

Agency Contacts (Chemical Managers): Selene Chou

APPENDIX A

MINIMAL RISK LEVEL (MRL) WORKSHEET

Chemical Name: Perfluoroheptanoic acid (PFHpA)
CAS Numbers: 375-85-9
Date: June 2018
Profile Status: Final, Pre-Public Comment
Route: Oral
Duration: Acute

MRL Summary: There are insufficient data for derivation of an acute-duration oral MRL for PFHpA.

Rationale for Not Deriving an MRL: No oral studies in laboratory animals were identified for PFHpA.

Agency Contacts (Chemical Managers): Selene Chou

APPENDIX A

MINIMAL RISK LEVEL (MRL) WORKSHEET

Chemical Name: Perfluoroheptanoic acid (PFHpA)
CAS Numbers: 375-85-9
Date: June 2018
Profile Status: Final, Pre-Public Comment
Route: Oral
Duration: Intermediate

MRL Summary: There are insufficient data for derivation of an intermediate-duration oral MRL for PFHpA.

Rationale for Not Deriving an MRL: No oral studies in laboratory animals were identified for PFHpA.

Agency Contacts (Chemical Managers): Selene Chou

APPENDIX A

MINIMAL RISK LEVEL (MRL) WORKSHEET

Chemical Name: Perfluoroheptanoic acid (PFHpA)
CAS Numbers: 375-85-9
Date: June 2018
Profile Status: Final, Pre-Public Comment
Route: Oral
Duration: Chronic

MRL Summary: There are insufficient data for derivation of a chronic-duration oral MRL for PFHpA.

Rationale for Not Deriving an MRL: No oral studies in laboratory animals were identified for PFHpA.

Agency Contacts (Chemical Managers): Selene Chou

APPENDIX A

MINIMAL RISK LEVEL (MRL) WORKSHEET

Chemical Name: Perfluorobutane sulfonic acid (PFBuS)
CAS Numbers: 375-73-5
Date: June 2018
Profile Status: Final, Pre-Public Comment
Route: Inhalation
Duration: Acute

MRL Summary: There are insufficient data for derivation of an acute-duration inhalation MRL for PFBuS.

Rationale for Not Deriving an MRL: No inhalation studies in laboratory animals were identified for PFBuS.

Agency Contacts (Chemical Managers): Selene Chou

APPENDIX A

MINIMAL RISK LEVEL (MRL) WORKSHEET

Chemical Name: Perfluorobutane sulfonic acid (PFBuS)
CAS Numbers: 375-73-5
Date: June 2018
Profile Status: Final, Pre-Public Comment
Route: Inhalation
Duration: Intermediate

MRL Summary: There are insufficient data for derivation of an intermediate-duration inhalation MRL for PFBuS.

Rationale for Not Deriving an MRL: No inhalation studies in laboratory animals were identified for PFBuS.

Agency Contacts (Chemical Managers): Selene Chou

APPENDIX A

MINIMAL RISK LEVEL (MRL) WORKSHEET

Chemical Name: Perfluorobutane sulfonic acid (PFBuS)
CAS Numbers: 375-73-5
Date: June 2018
Profile Status: Final, Pre-Public Comment
Route: Inhalation
Duration: Chronic

MRL Summary: There are insufficient data for derivation of a chronic-duration inhalation MRL for PFBuS.

Rationale for Not Deriving an MRL: No inhalation studies in laboratory animals were identified for PFBuS.

Agency Contacts (Chemical Managers): Selene Chou

APPENDIX A

MINIMAL RISK LEVEL (MRL) WORKSHEET

Chemical Name: Perfluorobutane sulfonic acid (PFBuS)
CAS Numbers: 375-73-5
Date: June 2018
Profile Status: Final, Pre-Public Comment
Route: Oral
Duration: Acute

MRL Summary: There are insufficient data for derivation of an acute-duration oral MRL for PFBuS.

Rationale for Not Deriving an MRL: No acute-duration oral studies in laboratory animals were identified for PFBuS.

Agency Contacts (Chemical Managers): Selene Chou

APPENDIX A

MINIMAL RISK LEVEL (MRL) WORKSHEET

Chemical Name: Perfluorobutane sulfonic acid (PFBuS)
CAS Numbers: 375-73-5
Date: June 2018
Profile Status: Final, Pre-Public Comment
Route: Oral
Duration: Intermediate

MRL Summary: There are insufficient data for derivation of an intermediate-duration oral MRL for PFBuS.

Rationale for Not Deriving an MRL: Laboratory animal studies for other perfluoroalkyl compounds have identified immunotoxicity and developmental toxicity as sensitive endpoints; these potential targets have not been investigated for PFBuS. Thus, the database was considered inadequate for identifying a critical endpoint and evaluating dose-response relationships.

Limited data available on the toxicity of PFBuS in laboratory animals have identified the liver, kidneys, stomach, and hematological systems as targets of toxicity. Decreases in hemoglobin and hematocrit levels were observed in male rats administered 200 mg/kg/day PFBuS for 90 days (Lieder et al. 2009a); decreases in erythrocyte levels were observed at 600 mg/kg/day. Administration of 600 mg/kg/day for 90 days also resulted in tubular and ductal papillary epithelial hyperplasia in the kidneys and necrosis and hyperplasia/hyperkeratosis in the forestomach (Lieder et al. 2009a). Effects in the liver consisted of decreases in plasma triglyceride levels in mice exposed to 30 mg/kg/day for 4–6 weeks (Bijland et al. 2011), increases in absolute and relative liver weight in male rats administered 300 mg/kg/day for at least 70 days (Lieder et al. 2009b) or 900 mg/kg/day for 28 days (3M 2001), and hepatocellular hypertrophy in rats administered 1,000 mg/kg/day in a 2-generation study (Lieder et al. 2009b). In general, no biologically relevant alterations in performance on FOB tests or motor activity tests were observed in rats administered 900 mg/kg/day PFBuS for 28 days (3M 2001) or 600 mg/kg/day for 90 days (Lieder et al. 2009a).

Agency Contacts (Chemical Managers): Selene Chou

APPENDIX A

MINIMAL RISK LEVEL (MRL) WORKSHEET

Chemical Name: Perfluorobutane sulfonic acid (PFBuS)
CAS Numbers: 375-73-5
Date: June 2018
Profile Status: Final, Pre-Public Comment
Route: Oral
Duration: Chronic

MRL Summary: There are insufficient data for derivation of a chronic-duration oral MRL for PFBuS.

Rationale for Not Deriving an MRL: No chronic-duration oral studies in laboratory animals were identified for PFBuS.

Agency Contacts (Chemical Managers): Selene Chou

APPENDIX A

MINIMAL RISK LEVEL (MRL) WORKSHEET

Chemical Name: Perfluorobutyric acid (PFBA)
CAS Numbers: 375-22-4
Date: June 2018
Profile Status: Final, Pre-Public Comment
Route: Inhalation
Duration: Acute

MRL Summary: There are insufficient data for derivation of an acute-duration inhalation MRL for PFBA.

Rationale for Not Deriving an MRL: No inhalation studies in laboratory animals were identified for PFBA.

Agency Contacts (Chemical Managers): Selene Chou

APPENDIX A

MINIMAL RISK LEVEL (MRL) WORKSHEET

Chemical Name: Perfluorobutyric acid (PFBA)
CAS Numbers: 375-22-4
Date: June 2018
Profile Status: Final, Pre-Public Comment
Route: Inhalation
Duration: Intermediate

MRL Summary: There are insufficient data for derivation of an intermediate-duration inhalation MRL for PFBA.

Rationale for Not Deriving an MRL: No inhalation studies in laboratory animals were identified for PFBA.

Agency Contacts (Chemical Managers): Selene Chou

APPENDIX A

MINIMAL RISK LEVEL (MRL) WORKSHEET

Chemical Name: Perfluorobutyric acid (PFBA)
CAS Numbers: 375-22-4
Date: June 2018
Profile Status: Final, Pre-Public Comment
Route: Inhalation
Duration: Chronic

MRL Summary: There are insufficient data for derivation of a chronic-duration inhalation MRL for PFBA.

Rationale for Not Deriving an MRL: No inhalation studies in laboratory animals were identified for PFBA.

Agency Contacts (Chemical Managers): Selene Chou

APPENDIX A

MINIMAL RISK LEVEL (MRL) WORKSHEET

Chemical Name: Perfluorobutyric acid (PFBA)
CAS Numbers: 375-22-4
Date: June 2018
Profile Status: Final, Pre-Public Comment
Route: Oral
Duration: Acute

MRL Summary: There are insufficient data for derivation of an acute-duration oral MRL for PFBA.

Rationale for Not Deriving an MRL: Laboratory animal studies for other perfluoroalkyl compounds have identified immunotoxicity and developmental toxicity as sensitive endpoints following acute-duration oral exposure; these potential targets have not been investigated for PFBA. Thus, the database was considered inadequate for identifying a critical endpoint and evaluating dose-response relationships.

Three studies have examined the acute toxicity of PFBA in laboratory animals for a limited number of potential endpoints. Ikeda et al. (1985) reported that administration of approximately 20 mg/kg/day PFBA in the diet to male rats for 2 weeks did not significantly affect relative liver weight, but increased catalase activity in liver homogenates by 42% and induced peroxisome proliferation, as assessed by electron microscopy. In a similar study, dietary administration of approximately 78 mg/kg/day PFBA to male mice for 10 days induced a 63% increase in absolute liver weight (Permadi et al. 1992). The increase in liver weight was accompanied by changes in enzymes involved in drug metabolism and/or in deactivation of reactive oxygen species; however, PFBA did not have a significant effect on parameters of peroxisomal fatty acid β -oxidation (Permadi et al. 1993). In a more comprehensive study, no significant effect on a wide range of endpoints including body and organ weights, hematology and clinical chemistry, and histopathology were observed in rats administered 184 mg/kg/day for 5 days (3M 2007a).

Agency Contacts (Chemical Managers): Selene Chou

APPENDIX A

MINIMAL RISK LEVEL (MRL) WORKSHEET

Chemical Name: Perfluorobutyric acid (PFBA)
CAS Numbers: 375-22-4
Date: June 2018
Profile Status: Final, Pre-Public Comment
Route: Oral
Duration: Intermediate

MRL Summary: There are insufficient data for derivation of an intermediate-duration oral MRL for PFBA.

Rationale for Not Deriving an MRL: The available intermediate-duration database was not considered adequate for derivation of an MRL. Although the available studies have examined potentially sensitive endpoints and developmental toxicity and both studies measured serum PFBA levels, the database is missing a reliable estimate of elimination half-life in humans. Chang et al. (2008b) reported serum half-lives in small groups of subjects (<10 subjects); only 2 of the subjects were females. Because developmental toxicity is one of the more sensitive endpoints, data from females is needed in order to estimate the HED.

The intermediate-duration oral database for PFBA consists of a developmental study in mice (Das et al. 2008) and 28- and 90-day gavage studies in rats (Butenhoff et al. 2012a; van Otterdijk 2007a, 2007b). In the developmental study, PFBA administered to pregnant mice on GDs 1–17 did not affect newborn weight gain or viability (Das et al. 2008). The most sensitive response was a delay in eye opening in the pups at maternal doses of PFBA of 35 mg/kg/day. In the 28- and 90-day studies, hyperplasia/hypertrophy of the follicular epithelium of the thyroid and hepatocellular hypertrophy were observed at ≥ 30 mg/kg/day (Butenhoff et al. 2012a; van Otterdijk 2007a, 2007b). In addition, the 90-day study reported hematological alterations in male rats dosed with 30 mg/kg/day PFBA. The NOAEL for these effects was 6 mg/kg/day.

Agency Contacts (Chemical Managers): Selene Chou

APPENDIX A

MINIMAL RISK LEVEL (MRL) WORKSHEET

Chemical Name: Perfluorobutyric acid (PFBA)
CAS Numbers: 375-22-4
Date: June 2018
Profile Status: Final, Pre-Public Comment
Route: Oral
Duration: Chronic

MRL Summary: There are insufficient data for derivation of a chronic-duration oral MRL for PFBA.

Rationale for Not Deriving an MRL: No chronic-duration oral studies in laboratory animals were identified for PFBA.

Agency Contacts (Chemical Managers): Selene Chou

APPENDIX A

MINIMAL RISK LEVEL (MRL) WORKSHEET

Chemical Name: Perfluorododecanoic acid (PFDoA)
CAS Numbers: 307-55-1
Date: June 2018
Profile Status: Final, Pre-Public Comment
Route: Inhalation
Duration: Acute

MRL Summary: There are insufficient data for derivation of an acute-duration inhalation MRL for PFDoA.

Rationale for Not Deriving an MRL: No inhalation studies in laboratory animals were identified for PFDoA.

Agency Contacts (Chemical Managers): Selene Chou

APPENDIX A

MINIMAL RISK LEVEL (MRL) WORKSHEET

Chemical Name: Perfluorododecanoic acid (PFDoA)
CAS Numbers: 307-55-1
Date: June 2018
Profile Status: Final, Pre-Public Comment
Route: Inhalation
Duration: Intermediate

MRL Summary: There are insufficient data for derivation of an intermediate-duration inhalation MRL for PFDoA.

Rationale for Not Deriving an MRL: No inhalation studies in laboratory animals were identified for PFDoA.

Agency Contacts (Chemical Managers): Selene Chou

APPENDIX A

MINIMAL RISK LEVEL (MRL) WORKSHEET

Chemical Name: Perfluorododecanoic acid (PFDoA)
CAS Numbers: 307-55-1
Date: June 2018
Profile Status: Final, Pre-Public Comment
Route: Inhalation
Duration: Chronic

MRL Summary: There are insufficient data for derivation of a chronic-duration inhalation MRL for PFDoA.

Rationale for Not Deriving an MRL: No inhalation studies in laboratory animals were identified for PFDoA.

Agency Contacts (Chemical Managers): Selene Chou

APPENDIX A

MINIMAL RISK LEVEL (MRL) WORKSHEET

Chemical Name: Perfluorododecanoic acid (PFDoA)
CAS Numbers: 307-55-1
Date: June 2018
Profile Status: Final, Pre-Public Comment
Route: Oral
Duration: Acute

MRL Summary: There are insufficient data for derivation of an acute-duration oral MRL for PFDoA.

Rationale for Not Deriving an MRL: The database was considered inadequate for derivation of an MRL.

Two studies have examined the acute-oral toxicity of PFDoA. Shi et al. (2007) reported decreases in body weight and decreases in serum testosterone and estradiol levels in rats following a 14-day gavage administration of 5 mg/kg/day (Shi et al. 2007). The study also reported an increase in serum cholesterol levels at 10 mg/kg/day. In the second study, Zhang et al. (2008) found increases in liver weight and hepatic triglyceride and cholesterol levels in rats administered via gavage ≥ 5 mg/kg/day for 14 days; these liver effects were not considered relevant to humans. Given the limited number of endpoints examined in Shi et al. (2007) this study, including the lack of histopathological examination, this study was not considered suitable for the derivation of an MRL.

Agency Contacts (Chemical Managers): Selene Chou

APPENDIX A

MINIMAL RISK LEVEL (MRL) WORKSHEET

Chemical Name: Perfluorododecanoic acid (PFDoA)
CAS Numbers: 307-55-1
Date: June 2018
Profile Status: Final, Pre-Public Comment
Route: Oral
Duration: Intermediate

MRL Summary: There are insufficient data for derivation of an intermediate-duration oral MRL for PFDoA.

Rationale for Not Deriving an MRL: One intermediate-duration study examined the oral toxicity of PFDoA. In this study, decreases in serum estradiol and increases in serum cholesterol were observed in pubertal females exposed to 3 mg/kg/day PFDoA on PNDs 24–72 (Shi et al. 2009).

Given the limited number of endpoints examined in this study, including the lack of histopathological examination, the database was not considered adequate for identifying the critical target of toxicity and thus for derivation of an MRL.

Agency Contacts (Chemical Managers): Selene Chou

APPENDIX A

MINIMAL RISK LEVEL (MRL) WORKSHEET

Chemical Name: Perfluorododecanoic acid (PFDoA)
CAS Numbers: 307-55-1
Date: June 2018
Profile Status: Final, Pre-Public Comment
Route: Oral
Duration: Chronic

MRL Summary: There are insufficient data for derivation of a chronic-duration oral MRL for PFDoA.

Rationale for Not Deriving an MRL: No chronic-duration oral studies in laboratory animals were identified for PFDoA.

Agency Contacts (Chemical Managers): Selene Chou

APPENDIX A

MINIMAL RISK LEVEL (MRL) WORKSHEET

Chemical Name: Perfluorooctanesulfonamide (PFOSA)
CAS Numbers: 754-91-6
Date: June 2018
Profile Status: Final, Pre-Public Comment
Route: Inhalation
Duration: Acute

MRL Summary: There are insufficient data for derivation of an acute-duration inhalation MRL for PFOSA.

Rationale for Not Deriving an MRL: No inhalation studies in laboratory animals were identified for PFOSA.

Agency Contacts (Chemical Managers): Selene Chou

APPENDIX A

MINIMAL RISK LEVEL (MRL) WORKSHEET

Chemical Name: Perfluorooctanesulfonamide (PFOSA)
CAS Numbers: 754-91-6
Date: June 2018
Profile Status: Final, Pre-Public Comment
Route: Inhalation
Duration: Intermediate

MRL Summary: There are insufficient data for derivation of an intermediate-duration inhalation MRL for PFOSA.

Rationale for Not Deriving an MRL: No inhalation studies in laboratory animals were identified for PFOSA.

Agency Contacts (Chemical Managers): Selene Chou

APPENDIX A

MINIMAL RISK LEVEL (MRL) WORKSHEET

Chemical Name: Perfluorooctanesulfonamide (PFOSA)
CAS Numbers: 754-91-6
Date: June 2018
Profile Status: Final, Pre-Public Comment
Route: Inhalation
Duration: Chronic

MRL Summary: There are insufficient data for derivation of a chronic-duration inhalation MRL for PFOSA.

Rationale for Not Deriving an MRL: No inhalation studies in laboratory animals were identified for PFOSA.

Agency Contacts (Chemical Managers): Selene Chou

APPENDIX A

MINIMAL RISK LEVEL (MRL) WORKSHEET

Chemical Name: Perfluorooctanesulfonamide (PFOSA)
CAS Numbers: 754-91-6
Date: June 2018
Profile Status: Final, Pre-Public Comment
Route: Oral
Duration: Acute

MRL Summary: There are insufficient data for derivation of an acute-duration oral MRL for PFOSA.

Rationale for Not Deriving an MRL: The acute-duration database for PFOSA was not considered adequate for identifying critical targets of toxicity because the Seacat and Luebker (2000) study only examined a limited number of potential endpoints and the potential developmental and immunological effects (sensitive targets for other perfluoroalkyl compounds) were not examined.

One laboratory animal study evaluated the acute oral toxicity of PFOSA. Seacat and Luebker (2000) did not find alterations in body weight or liver weight in rats administered a single dose of 5 mg/kg/day PFOSA.

Agency Contacts (Chemical Managers): Selene Chou

APPENDIX A

MINIMAL RISK LEVEL (MRL) WORKSHEET

Chemical Name: Perfluorooctanesulfonamide (PFOSA)
CAS Numbers: 754-91-6
Date: June 2018
Profile Status: Final, Pre-Public Comment
Route: Oral
Duration: Intermediate

MRL Summary: There are insufficient data for derivation of an intermediate-duration oral MRL for PFOSA.

Rationale for Not Deriving an MRL: No intermediate-duration oral studies in laboratory animals were identified for PFOSA.

Agency Contacts (Chemical Managers): Selene Chou

APPENDIX A

MINIMAL RISK LEVEL (MRL) WORKSHEET

Chemical Name: Perfluorooctanesulfonamide (PFOSA)
CAS Numbers: 754-91-6
Date: June 2018
Profile Status: Final, Pre-Public Comment
Route: Oral
Duration: Chronic

MRL Summary: There are insufficient data for derivation of a chronic-duration oral MRL for PFOSA.

Rationale for Not Deriving an MRL: No chronic-duration oral studies in laboratory animals were identified for PFOSA.

Agency Contacts (Chemical Managers): Selene Chou

APPENDIX A

MINIMAL RISK LEVEL (MRL) WORKSHEET

Chemical Name: Perfluorohexanoic acid (PFHxA)
CAS Numbers: 307-24-4
Date: June 2018
Profile Status: Final, Pre-Public Comment
Route: Inhalation
Duration: Acute

MRL Summary: There are insufficient data for derivation of an acute-duration inhalation MRL for PFHxA.

Rationale for Not Deriving an MRL: No acute-duration inhalation studies in laboratory animals were identified for PFHxA.

Agency Contacts (Chemical Managers): Selene Chou

APPENDIX A

MINIMAL RISK LEVEL (MRL) WORKSHEET

Chemical Name: Perfluorohexanoic acid (PFHxA)
CAS Numbers: 307-24-4
Date: June 2018
Profile Status: Final, Pre-Public Comment
Route: Inhalation
Duration: Intermediate

MRL Summary: There are insufficient data for derivation of an intermediate-duration inhalation MRL for PFHxA.

Rationale for Not Deriving an MRL: No intermediate-duration inhalation studies in laboratory animals were identified for PFHxA.

Agency Contacts (Chemical Managers): Selene Chou

APPENDIX A

MINIMAL RISK LEVEL (MRL) WORKSHEET

Chemical Name: Perfluorohexanoic acid (PFHxA)
CAS Numbers: 307-24-4
Date: June 2018
Profile Status: Final, Pre-Public Comment
Route: Inhalation
Duration: Chronic

MRL Summary: There are insufficient data for derivation of a chronic-duration inhalation MRL for PFHxA.

Rationale for Not Deriving an MRL: No chronic-duration inhalation studies in laboratory animals were identified for PFHxA.

Agency Contacts (Chemical Managers): Selene Chou

APPENDIX A

MINIMAL RISK LEVEL (MRL) WORKSHEET

Chemical Name: Perfluorohexanoic acid (PFHxA)
CAS Numbers: 307-24-4
Date: June 2018
Profile Status: Final, Pre-Public Comment
Route: Oral
Duration: Acute

MRL Summary: There are insufficient data for derivation of an acute-duration oral MRL for PFHxA.

Rationale for Not Deriving an MRL: The acute database for PFHxA was not considered adequate for derivation of an MRL because serum PFHxA levels at the lowest LOAEL were below the detection limit and an elimination half-life has not been estimated for humans; both of these toxicokinetic parameters are needed to estimate HEDs.

Two developmental toxicity studies conducted by Iwai and Hoberman (2014) examined the acute toxicity of PFHxA following gavage administration. Increases in stillborn pups and decreases in pup body weight were observed at 175 mg/kg/day; no effects were observed at 35 mg/kg/day. In the second study, decreases in birth weight and delayed eye opening was observed at 350 mg/kg/day; the NOAEL was 100 mg/kg/day. These studies were not considered adequate for derivation of an MRL because the measured serum PFHxA levels at 35 and 175 mg/kg/day groups were below the limit of detection. Additionally, the elimination half-life has not been estimated in humans.

Agency Contacts (Chemical Managers): Selene Chou

APPENDIX A

MINIMAL RISK LEVEL (MRL) WORKSHEET

Chemical Name: Perfluorohexanoic acid (PFHxA)
CAS Numbers: 307-24-4
Date: June 2018
Profile Status: Final, Pre-Public Comment
Route: Oral
Duration: Intermediate

MRL Summary: There are insufficient data for derivation of an acute-duration oral MRL for PFHxA.

Rationale for Not Deriving an MRL: No intermediate-duration oral studies in laboratory animals were identified for PFHxA.

Agency Contacts (Chemical Managers): Selene Chou

APPENDIX A

MINIMAL RISK LEVEL (MRL) WORKSHEET

Chemical Name: Perfluorohexanoic acid (PFHxA)
CAS Numbers: 307-24-4
Date: June 2018
Profile Status: Final, Pre-Public Comment
Route: Oral
Duration: Chronic

MRL Summary: There are insufficient data for derivation of a chronic-duration oral MRL for PFHxA.

Rationale for Not Deriving an MRL: The chronic duration oral database for PFHxA is not considered adequate for derivation of a chronic MRL because the only study available did not measure serum PFHxA levels and elimination half-life data are not available for humans. These toxicokinetic data are needed to derive HEDs.

One study has evaluated the chronic oral toxicity of PFHxA in laboratory animals (Klaunig et al. 2015). Exposure to female rats to 200 mg/kg/day resulted in hematological alterations (decreases in red blood cells and hemoglobin levels and increases in reticulocyte counts), renal effects (tubular degeneration, necrosis, increased urine volume and reduced specific gravity), and liver effects (necrosis); no adverse alterations were observed at 30 mg/kg/day or at 100 mg/kg/day in males. This study was not considered suitable for derivation of an MRL because serum PFHxA levels were not measured. Additionally, an elimination half-life has not been estimated in humans.

Agency Contacts (Chemical Managers): Selene Chou

APPENDIX B. LITERATURE SEARCH FRAMEWORK FOR PERFLUOROALKYLS

The objective of the toxicological profile is to evaluate the potential for human exposure and the potential health hazards associated with inhalation, oral, or dermal/ocular exposure to perfluoroalkyls.

B.1 LITERATURE SEARCH AND SCREEN

A literature search and screen was conducted to identify studies examining health effects, toxicokinetics, mechanisms of action, susceptible populations, biomarkers, chemical interactions, physical and chemical properties, production, use, environmental fate, environmental releases, and environmental and biological monitoring data for perfluoroalkyls. ATSDR primarily focused on peer-reviewed articles without publication date or language restrictions. Non-peer-reviewed studies that were considered relevant to the assessment of the health effects of perfluoroalkyls have undergone peer review by at least three ATSDR-selected experts who have been screened for conflict of interest. The inclusion criteria used to identify relevant studies examining the health effects of perfluoroalkyls are presented in Table B-1.

Table B-1. Inclusion Criteria for the Literature Search and Screen

Health Effects

Species

Human

Laboratory mammals

Route of exposure

Inhalation

Oral

Dermal (or ocular)

Parenteral (these studies will be considered supporting data)

Health outcome

Death

Systemic effects

Body weight effects

Respiratory effects

Cardiovascular effects

Gastrointestinal effects

Hematological effects

Musculoskeletal effects

Hepatic effects

Renal effects

Dermal effects

Ocular effects

Endocrine effects

Immunological effects

Neurological effects

Reproductive effects

Developmental effects

Table B-1. Inclusion Criteria for the Literature Search and Screen

Other noncancer effects
Cancer
Toxicokinetics
Absorption
Distribution
Metabolism
Excretion
PBPK models
Biomarkers
Biomarkers of exposure
Biomarkers of effect
Interactions with other chemicals
Potential for human exposure
Releases to the environment
Air
Water
Soil
Environmental fate
Transport and partitioning
Transformation and degradation
Environmental monitoring
Air
Water
Sediment and soil
Other media
Biomonitoring
General populations
Occupation populations

B.1.1 Literature Search

The current literature search was intended to update the draft toxicological profile for perfluoroalkyls released for public comment in 2015. The following main databases were searched in March 2008, September/October 2013, and May 2016:

- PubMed
- National Library of Medicine's TOXLINE
- Scientific and Technical Information Network's TOXCENTER

The search strategy used the chemical names, Chemical Abstracts Service (CAS) numbers, synonyms, and Medical Subject Headings (MeSH) terms for perfluoroalkyls. The query strings used for the literature search are presented in Table B-2.

APPENDIX B

The search was augmented by searching the Toxic Substances Control Act Test Submissions (TSCATS), NTP website, and National Institute of Health Research Portfolio Online Reporting Tools Expenditures and Results (NIH RePORTER) databases using the queries presented in Table B-3. Additional databases were searched in the creation of various tables and figures, such as the TRI Explorer, the Substance priority list (SPL) resource page, and other items as needed. Regulations applicable to perfluoroalkyls were identified by searching international and U.S. agency websites and documents.

Review articles were identified and used for the purpose of providing background information and identifying additional references. ATSDR also identified reports from the grey literature, which included unpublished research reports, technical reports from government agencies, conference proceedings and abstracts, and theses and dissertations.

Table B-2. Database Query Strings Post Public Comment Searches

Database search date	Query string
PubMed	
05/24/2016	<pre> ((((("1,1,2,2,3,3,4,4,4-Nonafluoro-1-butanefluoric acid"[tw] OR "1,1,2,2,3,3,4,4,4-Nonafluorobutane-1-sulphonic acid"[tw] OR "1,1,2,2,3,3,4,4,5,5,6,6,6-Tridecafluorohexane-1-sulfonic acid"[tw] OR "1-Perfluorobutanefluoric acid"[tw] OR "2,2,3,3,4,4,5,5,6,6,7,7,8,8,9,9,9-heptadecafluoro-Nonanoic acid"[tw] OR "2-(N-Ethyl-perfluorooctane sulfonamido) acetic acid"[tw] OR "2-(N-Methyl-perfluorooctane sulfonamido) acetic acid"[tw] OR "C11-PFA"[tw] OR "et-pfosa-acoh"[tw] OR "Glycine, N-ethyl-N-((1,1,2,2,3,3,4,4,5,5,6,6,7,7,8,8,8-heptadecafluorooctyl)sulfonyl)-"[tw] OR "Hencosafuoroundecanoic acid"[tw] OR "heptadecafluoro-1-octane sulfonic acid"[tw] OR "Heptadecafluoro-1-octanesulfonic acid"[tw] OR "heptadecafluorooctane sulfonic acid"[tw] OR "Heptadecafluorooctane-1-sulphonic acid"[tw] OR "Heptadecafluorooctanesulphonamide"[tw] OR "Heptafluoro-1-butanefluoric acid"[tw] OR "Heptafluorobutanefluoric acid"[tw] OR "Heptafluorobutyric acid"[tw] OR "me-pfosa-acoh"[tw] OR "N-Ethyl-N-((heptadecafluorooctyl)sulphonyl)glycine"[tw] OR "Ndfda"[tw] OR "Nonadecafluoro-n-decanoic acid"[tw] OR "Nonadecafluorodecanoic acid"[tw] OR "Nonafluoro-1-butanefluoric acid"[tw] OR "Nonafluorobutanefluoric acid"[tw] OR "Pentadecafluoro-1-octanoic acid"[tw] OR "Pentadecafluoro-n-octanoic acid"[tw] OR "Pentadecafluorooctanoic acid"[tw] OR "Pentyl perfluorobutanoate"[tw] OR "Perfluoro-n-decanoic acid"[tw] OR "Perfluoro-n-heptanoic acid"[tw] OR "Perfluoro-n-nonanoic acid"[tw] OR "Perfluoro-n-undecanoic acid"[tw] OR "Perfluorobutane sulfonic acid"[tw] OR "Perfluorobutanefluoric acid"[tw] OR "Perfluorobutanefluoric acid"[tw] OR "Perfluorobutyric acid"[tw] OR "Perfluorocaproic acid"[tw] OR "Perfluorooctanoic acid"[tw] OR "Perfluorooctylsulfonamide"[tw] OR "Perfluorodecanoic acid"[tw] OR "Perfluorododecanoic acid"[tw] OR "Perfluoroheptanecarboxylic acid"[tw] OR "Perfluoroheptanoic acid"[tw] OR "Perfluorohexane sulfonic acid"[tw] OR "Perfluorohexane-1-sulphonic acid"[tw] OR "perfluorohexanesulfonate"[tw] OR "perfluorohexanesulfonic acid"[tw] OR "Perfluorolauric acid"[tw] OR "Perfluorononane-1-oic acid"[tw] OR "Perfluorononanoic acid"[tw] OR "Perfluorooctane sulfonamide"[tw] OR "Perfluorooctane sulfonate"[tw] OR "Perfluorooctane sulfonic acid"[tw] OR "perfluorooctane sulphonic acid"[tw] OR "Perfluorooctanesulfonamide"[tw] OR "Perfluorooctanesulfonate"[tw] OR "Perfluorooctanesulfonic acid amide"[tw] OR "perfluorooctanesulfonic acid"[tw] OR "Perfluorooctanoic acid"[tw] OR "Perfluorooctylsulfonic acid"[tw] OR "Perfluoropropanecarboxylic acid"[tw] OR "Perfluoroundecanoic acid"[tw] OR "pfbus"[tw] OR "PFDA"[tw] OR "pfdea"[tw] OR "pfdoa"[tw] OR "Pfhpa"[tw] OR "PFHS cpd"[tw] OR "pfxs"[tw] OR "pfna"[tw] OR "PFOA"[tw] OR "PFOS"[tw] OR "pfsoa"[tw] OR "PfuA"[tw] OR "Tricosafuorododecanoic acid"[tw] OR "Tridecafluoro-1-heptanoic acid"[tw] OR "Tridecafluoroheptanoic acid"[tw] AND (2013/09/01:3000[crdat] OR 2013/09/01:3000[edat])) NOT medline[sb]))) OR (((("1,1,2,2,3,3,4,4,4-Nonafluoro-1-butanefluoric acid"[tw] OR "1,1,2,2,3,3,4,4,4-Nonafluorobutane-1-sulphonic acid"[tw] OR "1,1,2,2,3,3,4,4,5,5,6,6,6-Tridecafluorohexane-1-sulfonic acid"[tw] OR "1-Perfluorobutanefluoric acid"[tw] OR "2,2,3,3,4,4,5,5,6,6,7,7,8,8,9,9,9-heptadecafluoro-Nonanoic acid"[tw] OR "2-(N-Ethyl-perfluorooctane sulfonamido) acetic acid"[tw] OR "2-(N-Methyl-perfluorooctane sulfonamido) acetic acid"[tw] OR "C11-PFA"[tw] OR "et-pfosa-acoh"[tw] OR "Glycine, N-ethyl-N-((1,1,2,2,3,3,4,4,5,5,6,6,7,7,8,8,8-heptadecafluorooctyl)sulfonyl)-"[tw] OR "Hencosafuoroundecanoic acid"[tw] OR "heptadecafluoro-1-octane sulfonic acid"[tw] OR "Heptadecafluoro-1-octanesulfonic acid"[tw] OR "heptadecafluorooctane sulfonic acid"[tw] OR </pre>

Table B-2. Database Query Strings Post Public Comment Searches

Database search date	Query string
	"Heptadecafluorooctane-1-sulphonic acid"[tw] OR "Heptadecafluorooctanesulphonamide"[tw] OR "Heptafluoro-1-butanolic acid"[tw] OR "Heptafluorobutanoic acid"[tw] OR "Heptafluorobutyric acid"[tw] OR "me-pfosa-acoh"[tw] OR "N-Ethyl-N-((heptadecafluorooctyl)sulphonyl)glycine"[tw] OR "Ndnda"[tw] OR "Nonadecafluoro-n-decanoic acid"[tw] OR "Nonadecafluorodecanoic acid"[tw] OR "Nonafluoro-1-butanefluoronic acid"[tw] OR "Nonafluorobutanefluoronic acid"[tw] OR "Pentadecafluoro-1-octanoic acid"[tw] OR "Pentadecafluoro-n-octanoic acid"[tw] OR "Pentadecafluorooctanoic acid"[tw] OR "Pentyl perfluorobutanoate"[tw] OR "Perfluoro-n-decanoic acid"[tw] OR "Perfluoro-n-heptanoic acid"[tw] OR "Perfluoro-n-nonanoic acid"[tw] OR "Perfluoro-n-undecanoic acid"[tw] OR "Perfluorobutane sulfonic acid"[tw] OR "Perfluorobutanefluoronic acid"[tw] OR "Perfluorobutanoic acid"[tw] OR "Perfluorobutyric acid"[tw] OR "Perfluorocaprylic acid"[tw] OR "Perfluorooctanoic acid"[tw] OR "Perfluorooctylsulfonamide"[tw] OR "Perfluorodecanoic acid"[tw] OR "Perfluorododecanoic acid"[tw] OR "Perfluorododecanoic acid"[tw] OR "Perfluoroheptanecarboxylic acid"[tw] OR "Perfluoroheptanoic acid"[tw] OR "Perfluoroheptane sulfonic acid"[tw] OR "Perfluoroheptane-1-sulphonic acid"[tw] OR "perfluoroheptanesulfonate"[tw] OR "perfluoroheptanesulfonic acid"[tw] OR "Perfluorolauric acid"[tw] OR "Perfluorononan-1-oic acid"[tw] OR "Perfluorononanoic acid"[tw] OR "Perfluorooctane sulfonamide"[tw] OR "Perfluorooctane sulfonate"[tw] OR "Perfluorooctane sulfonic acid"[tw] OR "perfluorooctane sulphonic acid"[tw] OR "Perfluorooctanesulfonamide"[tw] OR "Perfluorooctanesulfonate"[tw] OR "Perfluorooctanesulfonic acid amide"[tw] OR "perfluorooctanesulfonic acid"[tw] OR "Perfluorooctanoic acid"[tw] OR "Perfluorooctylsulfonic acid"[tw] OR "Perfluoropropanecarboxylic acid"[tw] OR "Perfluoroundecanoic acid"[tw] OR "pfbus"[tw] OR "PFDA"[tw] OR "pfdea"[tw] OR "pfdoa"[tw] OR "Pfhpa"[tw] OR "PFHS cpd"[tw] OR "pfhxs"[tw] OR "pfna"[tw] OR "PFOA"[tw] OR "PFOS"[tw] OR "pfsoa"[tw] OR "Pfua"[tw] OR "Tricosafuorododecanoic acid"[tw] OR "Tridecafluoro-1-heptanoic acid"[tw] OR "Tridecafluoroheptanoic acid"[tw] OR 1763-23-1[rn] OR 2058-94-8[rn] OR 2355-31-9[rn] OR 2991-50-6[rn] OR 307-55-1[rn] OR 335-67-1[rn] OR 335-76-2[rn] OR 355-46-4[rn] OR 375-22-4[rn] OR 375-73-5[rn] OR 375-85-9[rn] OR 375-95-1[rn] OR 754-91-6[rn] AND (2013/09/01:3000[mhda] OR 2013/09/01:3000[crdat] OR 2013/09/01:3000[edat]) AND (to[sh] OR po[sh] OR ae[sh] OR pk[sh] OR ai[sh] OR ci[sh] OR bl[sh] OR cf[sh] OR ur[sh] OR "pharmacology"[sh:noexp] OR "environmental exposure"[mh] OR "endocrine system"[mh] OR "hormones, hormone substitutes, and hormone antagonists"[mh] OR "endocrine disruptors"[mh] OR "Computational biology"[mh] OR "Medical Informatics"[mh] OR Genomics[mh] OR Genome[mh] OR Proteomics[mh] OR Proteome[mh] OR Metabolomics[mh] OR Metabolome[mh] OR Genes[mh] OR "Gene expression"[mh] OR Phenotype[mh] OR genetics[mh] OR genotype[mh] OR Transcriptome[mh] OR ("Systems Biology"[mh] AND ("Environmental Exposure"[mh] OR "Epidemiological Monitoring"[mh] OR analysis[sh])) OR "Transcription, Genetic "[mh] OR "Reverse transcription"[mh] OR "Transcriptional activation"[mh] OR "Transcription factors"[mh] OR ("biosynthesis"[sh] AND (RNA[mh] OR DNA[mh])) OR "RNA, Messenger "[mh] OR "RNA, Transfer"[mh] OR "peptide biosynthesis"[mh] OR "protein biosynthesis"[mh] OR "Reverse Transcriptase Polymerase Chain Reaction"[mh] OR "Base Sequence"[mh] OR "Trans-activators"[mh] OR "Gene Expression Profiling"[mh] OR cancer[sb] OR (me[sh] AND ("humans"[mh] OR "animals"[mh])))
10/03/2013	("Computational biology"[mh] OR "Medical Informatics"[mh] OR Genomics[mh] OR Genome[mh] OR Proteomics[mh] OR Proteome[mh] OR Metabolomics[mh] OR Metabolome[mh] OR Genes[mh] OR "Gene expression"[mh] OR Phenotype[mh] OR genetics[mh] OR genotype[mh] OR Transcriptome[mh] OR ("Systems Biology"[mh] AND ("Environmental Exposure"[mh] OR "Epidemiological Monitoring"[mh] OR analysis[sh])) OR "Transcription, Genetic "[mh] OR "Reverse transcription"[mh] OR "Transcriptional activation"[mh] OR "Transcription factors"[mh] OR ("biosynthesis"[sh] AND (RNA[mh] OR DNA[mh])) OR "RNA, Messenger "[mh] OR "RNA, Transfer"[mh] OR "peptide biosynthesis"[mh] OR "protein biosynthesis"[mh] OR "Reverse Transcriptase Polymerase Chain Reaction"[mh] OR "Base Sequence"[mh] OR "Trans-activators"[mh] OR "Gene Expression Profiling"[mh] AND ((335-67-1[rn] OR 1763-23-1[rn] OR 355-46-4[rn] OR 2991-50-6[rn] OR 2355-31-9[rn] OR 335-76-2[rn] OR 375-73-5[rn] OR 375-85-9[rn] OR 375-95-1[rn] OR 754-91-6[rn] OR 2058-94-8[rn] OR 307-55-1[rn] OR 375-22-4[rn] OR 80AM718FML[rn]) AND 2007/05/01:2013/10/03[dp])
09/19/2013	((((335-67-1[rn] OR 1763-23-1[rn] OR 355-46-4[rn] OR 2991-50-6[rn] OR 2355-31-9[rn] OR 335-76-2[rn] OR 375-73-5[rn] OR 375-85-9[rn] OR 375-95-1[rn] OR 754-91-6[rn] OR 2058-94-8[rn] OR 307-55-1[rn] OR 375-22-4[rn] OR 80AM718FML[rn]) AND 2007/05/01:2013/10/03[dp])

Table B-2. Database Query Strings Post Public Comment Searches

Database search date	Query string
	<p>55-1[rn] OR 375-22-4[rn] OR 80AM718FML[rn]) AND 2007/05/01:2013/09/19[dp]) AND (((Caprylates/metabolism[MeSH Terms] OR Fluorocarbons/metabolism[MeSH Terms] OR "Alkanesulfonic Acids/metabolism"[MeSH Terms] OR "Sulfonic Acids/metabolism"[MeSH Terms] OR "Decanoic Acids/metabolism"[MeSH Terms] OR "Heptanoic Acids/metabolism"[MeSH Terms] OR "Hydrocarbons, Fluorinated/metabolism"[MeSH Terms] OR "Fatty Acids/metabolism"[MeSH Terms] OR Sulfonamides/metabolism[MeSH Terms]) AND ("humans"[MeSH Terms] OR "animals"[MeSH Terms])) OR ((Caprylates[MeSH Terms] OR Fluorocarbons[MeSH Terms] OR "Alkanesulfonic Acids"[MeSH Terms] OR "Sulfonic Acids"[MeSH Terms] OR "Decanoic Acids"[MeSH Terms] OR "Heptanoic Acids"[MeSH Terms] OR "Hydrocarbons, Fluorinated"[MeSH Terms] OR "Fatty Acids"[MeSH Terms] OR Sulfonamides[MeSH Terms]) AND (Endocrine System[mh] OR Hormones[mh] OR Endocrine disruptors[mh])) OR ((Caprylates[MeSH Terms] OR Fluorocarbons[MeSH Terms] OR "Alkanesulfonic Acids"[MeSH Terms] OR "Sulfonic Acids"[MeSH Terms] OR "Decanoic Acids"[MeSH Terms] OR "Heptanoic Acids"[MeSH Terms] OR "Hydrocarbons, Fluorinated"[MeSH Terms] OR "Fatty Acids"[MeSH Terms] OR Sulfonamides[MeSH Terms]) AND "environmental exposure"[MeSH Terms]) OR ((Caprylates[MeSH Terms] OR Fluorocarbons[MeSH Terms] OR "Alkanesulfonic Acids"[MeSH Terms] OR "Sulfonic Acids"[MeSH Terms] OR "Decanoic Acids"[MeSH Terms] OR "Heptanoic Acids"[MeSH Terms] OR "Hydrocarbons, Fluorinated"[MeSH Terms] OR "Fatty Acids"[MeSH Terms] OR Sulfonamides[MeSH Terms]) AND "chemically induced"[MeSH Subheading]) OR (((((((("caprylates/adverse effects"[MeSH Terms] OR "caprylates/antagonists and inhibitors"[MeSH Terms] OR "caprylates/blood"[MeSH Terms] OR "caprylates/cerebrospinal fluid"[MeSH Terms] OR "caprylates/pharmacokinetics"[MeSH Terms] OR "caprylates/poisoning"[MeSH Terms] OR "caprylates/toxicity"[MeSH Terms] OR "caprylates/urine"[MeSH Terms]))) OR ("fluorocarbons/adverse effects"[MeSH Terms] OR "fluorocarbons/antagonists and inhibitors"[MeSH Terms] OR "fluorocarbons/blood"[MeSH Terms] OR "fluorocarbons/pharmacokinetics"[MeSH Terms] OR "fluorocarbons/poisoning"[MeSH Terms] OR "fluorocarbons/toxicity"[MeSH Terms] OR "fluorocarbons/urine"[MeSH Terms]))) OR (("alkanesulfonic acids/adverse effects"[MeSH Terms] OR "alkanesulfonic acids/antagonists and inhibitors"[MeSH Terms] OR "alkanesulfonic acids/blood"[MeSH Terms] OR "alkanesulfonic acids/cerebrospinal fluid"[MeSH Terms] OR "alkanesulfonic acids/pharmacokinetics"[MeSH Terms] OR "alkanesulfonic acids/poisoning"[MeSH Terms] OR "alkanesulfonic acids/toxicity"[MeSH Terms] OR "alkanesulfonic acids/urine"[MeSH Terms]))) OR ("sulfonic acids/adverse effects"[MeSH Terms] OR "sulfonic acids/antagonists and inhibitors"[MeSH Terms] OR "sulfonic acids/blood"[MeSH Terms] OR "sulfonic acids/cerebrospinal fluid"[MeSH Terms] OR "sulfonic acids/pharmacokinetics"[MeSH Terms] OR "sulfonic acids/poisoning"[MeSH Terms] OR "sulfonic acids/toxicity"[MeSH Terms] OR "sulfonic acids/urine"[MeSH Terms]))) OR ("decanoic acids/adverse effects"[MeSH Terms] OR "decanoic acids/antagonists and inhibitors"[MeSH Terms] OR "decanoic acids/blood"[MeSH Terms] OR "decanoic acids/pharmacokinetics"[MeSH Terms] OR "decanoic acids/poisoning"[MeSH Terms] OR "decanoic acids/toxicity"[MeSH Terms] OR "decanoic acids/urine"[MeSH Terms]))) OR ("heptanoic acids/adverse effects"[MeSH Terms] OR "heptanoic acids/antagonists and inhibitors"[MeSH Terms] OR "heptanoic acids/blood"[MeSH Terms] OR "heptanoic acids/cerebrospinal fluid"[MeSH Terms] OR "heptanoic acids/pharmacokinetics"[MeSH Terms] OR "heptanoic acids/poisoning"[MeSH Terms] OR "heptanoic acids/toxicity"[MeSH Terms] OR "heptanoic acids/urine"[MeSH Terms]))) OR ("hydrocarbons, fluorinated/adverse effects"[MeSH Terms] OR "hydrocarbons, fluorinated/antagonists and inhibitors"[MeSH Terms] OR "hydrocarbons, fluorinated/blood"[MeSH Terms] OR "hydrocarbons, fluorinated/cerebrospinal fluid"[MeSH Terms] OR "hydrocarbons, fluorinated/pharmacokinetics"[MeSH Terms] OR "hydrocarbons, fluorinated/toxicity"[MeSH Terms] OR "hydrocarbons, fluorinated/urine"[MeSH Terms]))) OR ("fatty acids/adverse effects"[MeSH Terms] OR "fatty acids/antagonists and inhibitors"[MeSH Terms] OR "fatty acids/blood"[MeSH Terms] OR "fatty acids/cerebrospinal fluid"[MeSH Terms] OR "fatty acids/pharmacokinetics"[MeSH Terms] OR "fatty acids/poisoning"[MeSH Terms] OR "fatty acids/toxicity"[MeSH Terms] OR "fatty acids/urine"[MeSH Terms]))) OR ("sulfonamides/adverse effects"[MeSH Terms] OR "sulfonamides/antagonists and inhibitors"[MeSH Terms] OR "sulfonamides/blood"[MeSH Terms] OR "sulfonamides/cerebrospinal fluid"[MeSH Terms] OR "sulfonamides/pharmacokinetics"[MeSH Terms] OR "sulfonamides/poisoning"[MeSH Terms] OR "sulfonamides/toxicity"[MeSH Terms] OR "sulfonamides/urine"[MeSH Terms]))) OR ("Perfluorooctanoic acid"[tw] OR "Pentadecafluoro-1-octanoic acid"[tw] OR "Pentadecafluoro-n-</p>

APPENDIX B

Table B-2. Database Query Strings Post Public Comment Searches

Database search date	Query string
	<p>octanoic acid"[tw] OR "Pentadecafluorooctanoic acid"[tw] OR "Perfluorocaprylic acid"[tw] OR "Perfluorooctanoic acid"[tw] OR "Perfluoroheptanecarboxylic acid"[tw] OR "Perfluorooctanoic acid"[tw] OR "Pentadecafluorooctanoic acid"[tw] OR "Perfluorooctanoic acid"[tw] OR "Perfluorooctane sulfonic acid"[tw] OR "Heptadecafluoro-1-octanesulfonic acid"[tw] OR "heptadecafluoro-1-octane sulfonic acid"[tw] OR "Heptadecafluorooctane-1-sulphonic acid"[tw] OR "heptadecafluorooctane sulfonic acid"[tw] OR "Perfluorooctane sulfonate"[tw] OR "Perfluorooctylsulfonic acid"[tw] OR "perfluorooctane sulphonic acid"[tw] OR "perfluorooctanesulfonic acid"[tw] OR "Perfluorooctanesulfonate"[tw] OR "Heptadecafluorooctane-1-sulphonic acid1-Perfluorooctanesulfonic acid"[tw] OR "Perfluorohexane sulfonic acid"[tw] OR "pfxs"[tw] OR "perfluorohexanesulfonic acid"[tw] OR "perfluorohexanesulfonate"[tw] OR "1,1,2,2,3,3,4,4,5,5,6,6,6-Tridecafluorohexane-1-sulfonic acid"[tw] OR "Perfluorohexane-1-sulphonic acid"[tw] OR "PFHS cpd"[tw] OR "2-(N-Ethyl-perfluorooctane sulfonamido) acetic acid"[tw] OR "et-pfosa-acoh"[tw] OR "N-Ethyl-N-((heptadecafluorooctyl)sulphonyl)glycine"[tw] OR "Glycine, N-ethyl-N-((1,1,2,2,3,3,4,4,5,5,6,6,7,7,8,8,8-heptadecafluorooctyl)sulfonyl)-"[tw] OR "2-(N-Methyl-perfluorooctane sulfonamido) acetic acid"[tw] OR "me-pfosa-acoh"[tw] OR "Perfluorodecanoic acid"[tw] OR "Nonadecafluoro-n-decanoic acid"[tw] OR "Nonadecafluorodecanoic acid"[tw] OR "Perfluoro-N-decanoic acid"[tw] OR "Perfluoro-n-decanoic acid"[tw] OR "Perfluorodecanoic acid"[tw] OR "Nonadecafluorodecanoic acid"[tw] OR "Perfluoro-N-decanoic acid"[tw] OR "Perfluorobutane sulfonic acid"[tw] OR "Perfluorobutanesulfonic acid"[tw] OR "1,1,2,2,3,3,4,4,4-Nonafluoro-1-butanefluorobutanesulfonic acid"[tw] OR "1-Perfluorobutanesulfonic acid"[tw] OR "Nonafluoro-1-butanefluorobutanesulfonic acid"[tw] OR "Nonafluorobutanesulfonic acid"[tw] OR "Pentyl perfluorobutanoate"[tw] OR "1,1,2,2,3,3,4,4,4-Nonafluorobutane-1-sulphonic acid"[tw] OR "Nonafluoro-1-butanefluorobutanesulfonic acid"[tw] OR "Perfluoroheptanoic acid"[tw] OR "Tridecafluoro-1-heptanoic acid"[tw] OR "Perfluoro-n-heptanoic acid"[tw] OR "Perfluoroheptanoic acid"[tw] OR "Tridecafluoroheptanoic acid"[tw] OR "Perfluorononanoic acid"[tw] OR "Perfluoro-n-nonanoic acid"[tw] OR "2,2,3,3,4,4,5,5,6,6,7,7,8,8,9,9,9-heptadecafluoro-Nonanoic acid"[tw] OR "Perfluorononan-1-oic acid"[tw] OR "Perfluorooctane sulfonamide"[tw] OR "Perfluorooctanesulfonamide"[tw] OR "Perfluorooctylsulfonamide"[tw] OR "Perfluorooctanesulfonic acid amide"[tw] OR "Heptadecafluorooctanesulphonamide"[tw] OR "Perfluoroundecanoic acid"[tw] OR "Perfluoro-n-undecanoic acid"[tw] OR "Henicosafuoroundecanoic acid"[tw] OR "Perfluorododecanoic acid "[tw] OR "Perfluorododecanoic acid"[tw] OR "Tricosafuorododecanoic acid"[tw] OR "Perfluorolauric acid"[tw] OR "Perfluorobutyric acid"[tw] OR "Heptafluorobutyric acid"[tw] OR "Heptafluoro-1-butanefluorobutanoic acid"[tw] OR "Heptafluorobutanoic acid"[tw] OR "Heptafluorobutyric acid"[tw] OR "Perfluorobutanoic acid"[tw] OR "Perfluoropropanecarboxylic acid"[tw] NOT medline[sb]) OR ("PFOA"[tw] OR "PFOS"[tw] OR "Pfaa"[tw] OR "pfdoa"[tw] OR "C11-PFA"[tw] OR "pfsoa"[tw] OR "pfna"[tw] OR "Pfhpa"[tw] OR "pfbus"[tw] OR "PFDA"[tw] OR "pfdea"[tw] OR "Ndfda"[tw]) NOT medline[sb])</p>
Toxcenter	
05/25/2016	FILE 'TOXCENTER' ENTERED AT 08:37:55 ON 25 MAY 2016
L1	5994 SEA 335-67-1 OR 1763-23-1 OR 355-46-4 OR 2991-50-6 OR 2355-31-9 OR 335-76-2 OR 375-73-5 OR 375-85-9 OR 375-95-1 OR 754-91-6 OR 2058-94-8 OR 307-55-1 OR 375-22-4
L2	5967 SEA L1 NOT TSCATS/FS
L3	5731 SEA L2 NOT PATENT/DT
L4	1847 SEA L3 AND ED>=20130701 ACT TOXQUERY/Q
L5	QUE (CHRONIC OR IMMUNOTOX? OR NEUROTOX? OR TOXICOKIN? OR BIOMARKER? OR NEUROLOG?)
L6	QUE (PHARMACOKIN? OR SUBCHRONIC OR PBPK OR EPIDEMIOLOGY/ST,CT, IT)
L7	QUE (ACUTE OR SUBACUTE OR LD50# OR LD(W)50 OR LC50# OR LC(W)50)
L8	QUE (TOXICITY OR ADVERSE OR POISONING)/ST,CT,IT
L9	QUE (INHAL? OR PULMON? OR NASAL? OR LUNG? OR RESPIR?)
L10	QUE ((OCCUPATION? OR WORKPLACE? OR WORKER?) AND EXPOS?)
L11	QUE (ORAL OR ORALLY OR INGEST? OR GAVAGE? OR DIET OR DIETS OR

APPENDIX B

Table B-2. Database Query Strings Post Public Comment Searches

Database search date	Query string
	DIETARY OR DRINKING(W)WATER?)
L12	QUE (MAXIMUM AND CONCENTRATION? AND (ALLOWABLE OR PERMISSIBLE))
L13	QUE (ABORT? OR ABNORMALIT? OR EMBRYO? OR CLEFT? OR FETUS?)
L14	QUE (FOETUS? OR FETAL? OR FOETAL? OR FERTIL? OR MALFORM? OR OVUM?)
L15	QUE (OVA OR OVARY OR PLACENTA? OR PREGNAN? OR PRENATAL?)
L16	QUE (PERINATAL? OR POSTNATAL? OR REPRODUC? OR STERIL? OR TERATOGEN?)
L17	QUE (SPERM OR SPERMAC? OR SPERMAG? OR SPERMATI? OR SPERMAS? OR SPERMATOB? OR SPERMATOC? OR SPERMATOG?)
L18	QUE (SPERMATOI? OR SPERMATOL? OR SPERMATOR? OR SPERMATOX? OR SPERMATOZ? OR SPERMATU? OR SPERMI? OR SPERMO?)
L19	QUE (NEONAT? OR NEWBORN? OR DEVELOPMENT OR DEVELOPMENTAL?)
L20	QUE (ENDOCRIN? AND DISRUPT?)
L21	QUE (ZYGOTE? OR CHILD OR CHILDREN OR ADOLESCEN? OR INFANT?)
L22	QUE (WEAN? OR OFFSPRING OR AGE(W)FACTOR?)
L23	QUE (DERMAL? OR DERMIS OR SKIN OR EPIDERM? OR CUTANEOUS?)
L24	QUE (CARCINOG? OR COCARCINOG? OR CANCER? OR PRECANCER? OR NEOPLAS?)
L25	QUE (TUMOR? OR TUMOUR? OR ONCOGEN? OR LYMPHOMA? OR CARCINOM?)
L26	QUE (GENETOX? OR GENOTOX? OR MUTAGEN? OR GENETIC(W)TOXIC?)
L27	QUE (NEPHROTOX? OR HEPATOTOX?)
L28	QUE (ENDOCRIN? OR ESTROGEN? OR ANDROGEN? OR HORMON?)
L29	QUE (OCCUPATION? OR WORKER? OR WORKPLACE? OR EPIDEM?)
L30	QUE L5 OR L6 OR L7 OR L8 OR L9 OR L10 OR L11 OR L12 OR L13 OR L14 OR L15 OR L16 OR L17 OR L18 OR L19 OR L20 OR L21 OR L22 OR L23 OR L24 OR L25 OR L26 OR L27 OR L28 OR L29
L31	QUE (RAT OR RATS OR MOUSE OR MICE OR GUINEA(W)PIG? OR MURIDAE OR DOG OR DOGS OR RABBIT? OR HAMSTER? OR PIG OR PIGS OR SWINE OR PORCINE OR MONKEY? OR MACAQUE?)
L32	QUE (MARMOSET? OR FERRET? OR GERBIL? OR RODENT? OR LAGOMORPHA OR BABOON? OR CANINE OR CAT OR CATS OR FELINE OR MURINE)
L33	QUE L30 OR L31 OR L32
L34	QUE (NONHUMAN MAMMALS)/ORGN
L35	QUE L33 OR L34
L36	QUE (HUMAN OR HUMANS OR HOMINIDAE OR MAMMALS OR MAMMAL? OR PRIMATES OR PRIMATE?)
L37	QUE L35 OR L36
L38	1318 SEA L4 AND L37
L39	1148 SEA L4 AND L30
L40	356 SEA L38 AND MEDLINE/FS
L41	297 SEA L38 AND BIOSIS/FS
L42	664 SEA L38 AND CAPLUS/FS
L43	1 SEA L38 NOT (MEDLINE/FS OR BIOSIS/FS OR CAPLUS/FS)
L44	931 DUP REM L40 L41 L43 L42 (387 DUPLICATES REMOVED)
L*** DEL	356 S L38 AND MEDLINE/FS
L*** DEL	356 S L38 AND MEDLINE/FS
L45	356 SEA L44
L*** DEL	297 S L38 AND BIOSIS/FS
L*** DEL	297 S L38 AND BIOSIS/FS
L46	190 SEA L44
L*** DEL	664 S L38 AND CAPLUS/FS
L*** DEL	664 S L38 AND CAPLUS/FS
L47	385 SEA L44
L48	575 SEA (L45 OR L46 OR L47) NOT MEDLINE/FS D SCAN L48

APPENDIX B

Table B-2. Database Query Strings Post Public Comment Searches

Database search date	Query string
09/19/2013	FILE 'TOXCENTER' ENTERED AT 09:10:51 ON 19 SEP 2013
L1	3993 SEA 335-67-1 OR 1763-23-1 OR 355-46-4 OR 2991-50-6 OR 2355-31-9 OR 335-76-2 OR 375-73-5 OR 375-85-9 OR 375-95-1 OR 754-91-6 OR 2058-94-8 OR 307-55-1 OR 375-22-4
L2	3966 SEA L1 NOT TSCATS/FS
L3	3782 SEA L2 NOT PATENT/DT
L4	2796 SEA L3 AND PY>2006 ACTIVATE TOXBROAD/Q
L5	QUE (CHRONIC OR IMMUNOTOX? OR NEUROTOX? OR TOXICOKIN? OR BIOMARKER? OR NEUROLOG?)
L6	QUE (PHARMACOKIN? OR SUBCHRONIC OR PBPK OR EPIDEMIOLOGY/ST,CT)
L7	QUE (ACUTE OR SUBACUTE OR LD50 OR LC50)
L8	QUE (TOXICITY OR ADVERSE OR POISONING)/ST,CT
L9	QUE (INHAL? OR PULMON? OR NASAL? OR LUNG? OR RESPIR?)
L10	QUE (VAPOR? OR VAPOUR? OR AEROSOL?)
L11	QUE ((OCCUPATION? OR WORKPLACE? OR WORKER?) AND EXPOS?)
L12	QUE (ORAL OR ORALLY OR INGEST? OR GAVAGE? OR DIET? OR DRINKING(W)WATER?)
L13	QUE (MAXIMUM AND CONCENTRATION? AND (ALLOWABLE OR PERMISSIBLE))
L14	QUE (ABORT? OR ABNORMALIT? OR EMBRYO? OR CLEFT? OR FETUS?)
L15	QUE (FOETUS? OR FETAL? OR FOETAL? OR FERTIL? OR MALFORM? OR OVUM?)
L16	QUE (OVA OR OVARY OR PLACENTA? OR PREGNAN? OR PRENATAL?)
L17	QUE (PERINATAL? OR POSTNATAL? OR REPRODUC? OR STERIL? OR TERATOGEN?)
L18	QUE (SPERM? OR NEONAT? OR NEWBORN? OR DEVELOPMENT OR DEVELOPMEN TAL?)
L19	QUE (ENDOCRIN? AND DISRUPT?)
L20	QUE (ZYGOTE? OR CHILD OR CHILDREN OR ADOLESCEN? OR INFANT?)
L21	QUE (WEAN? OR OFFSPRING OR AGE(W)FACTOR?)
L22	QUE (DERMAL? OR DERMIS OR SKIN OR EPIDERM? OR CUTANEOUS?)
L23	QUE (CARCINO? OR COCARCINO? OR CANCER? OR PRECANCER? OR NEOPLAS?)
L24	QUE (TUMOR? OR TUMOUR? OR ONCOGEN? OR LYMPHOMA? OR CARCINOM?)
L25	QUE (GENETOX? OR GENOTOX? OR MUTAGEN?)
L26	QUE GENETIC(W)TOXIC?
L27	QUE L5 OR L6 OR L7 OR L9 OR L10 OR L11 OR L12 OR L13 OR L14 OR L15 OR L16 OR L17 OR L18 OR L19 OR L20 OR L21
L28	QUE L27 OR L22 OR L23 OR L24 OR L25 OR L26
L29	QUE L28 OR L8
L30	QUE NEPHROTOX? OR HEPATOTOX? OR ENDOCRIN? OR ESTROGEN? OR ANDROGEN? OR HORMON?
L31	QUE L29 OR L30
L32	QUE RAT OR RATS OR MOUSE OR MICE OR GUINEA PIG OR MURIDAE OR DOG OR DOGS OR RABBIT? OR HAMSTER? OR PIG OR PIGS OR SWINE OR PORCINE OR GOAT OR GOATS OR SHEEP OR MONKEY? OR MACAQUE?
L33	QUE MARMOSET? OR FERRET? OR GERBIL? OR HAMSTER? OR RODENT? OR LAGOMORPHA OR BABOON? OR BOVINE OR CANINE OR CAT OR CATS OR FELINE OR PIGEON?
L34	QUE OCCUPATION? OR WORKER? OR WORKPLACE? OR EPIDEM?
L35	QUE L31 OR L32 OR L33 OR L34
L36	QUE NONHUMAN MAMMALS/ORGN
L37	QUE L35 OR L36
L38	QUE HUMAN? OR HOMINIDAE OR MAMMAL? OR PRIMATE?
L39	QUE L37 OR L38

APPENDIX B

Table B-2. Database Query Strings Post Public Comment Searches

Database search date	Query string
L40	2012 SEA L4 AND L39
L41	619 SEA L40 AND MEDLINE/FS
L42	417 SEA L40 AND BIOSIS/FS
L43	975 SEA L40 AND CAPLUS/FS
L44	1 SEA L40 NOT (MEDLINE/FS OR BIOSIS/FS OR CAPLUS/FS)
L45	1308 DUP REM L41 L42 L44 L43 (704 DUPLICATES REMOVED)
L*** DEL	619 S L40 AND MEDLINE/FS
L*** DEL	619 S L40 AND MEDLINE/FS
L46	619 SEA L45
L*** DEL	417 S L40 AND BIOSIS/FS
L*** DEL	417 S L40 AND BIOSIS/FS
L47	217 SEA L45
L*** DEL	975 S L40 AND CAPLUS/FS
L*** DEL	975 S L40 AND CAPLUS/FS
L48	471 SEA L45
L*** DEL	1 S L40 NOT (MEDLINE/FS OR BIOSIS/FS OR CAPLUS/FS)
L*** DEL	1 S L40 NOT (MEDLINE/FS OR BIOSIS/FS OR CAPLUS/FS)
L49	1 SEA L45
L50	689 SEA (L46 OR L47 OR L48 OR L49) NOT MEDLINE/FS SAVE TEMP L50 PERFLUOROALKYLS/A PFOA/A
L51	217 SEA L50 AND BIOSIS/FS
L52	471 SEA L50 AND CAPLUS/FS
L53	220 SEA L52 AND 4-?/CC
L54	1 SEA L50 NOT (MEDLINE/FS OR BIOSIS/FS OR CAPLUS/FS)
L55	438 SEA L51 OR L53 OR L54
L56	689 SEA L55 OR L52 D SCAN L55

ToxLine

05/24/2016 (((("C11-PFA" OR "et-pfosa-acoh" OR "Henicosafuoroundecanoic acid" OR "heptadecafluoro-1-octane sulfonic acid" OR "Heptadecafluoro-1-octanesulfonic acid" OR "heptadecafluorooctane sulfonic acid" OR "Heptadecafluorooctane-1-sulphonic acid" OR "Heptadecafluorooctane-1-sulphonid acid" OR "Perfluorooctanesulfonic acid" OR "Heptadecafluorooctanesulphonamide" OR "Heptafluoro-1-butanoic acid" OR "Heptafluorobutanoic acid" OR "Heptafluorobutyric acid" OR "me-pfosa-acoh" OR "N-Ethyl-N-((heptadecafluorooctyl)sulphonyl)glycine" OR "Ndfda" OR "Nonadecafluoro-n-decanoic acid" OR "Nonadecafluorodecanoic acid" OR "Nonafluoro-1-butanefluorobutanesulfonic acid" OR "Nonafluorobutanefluorobutanesulfonic acid" OR "Pentadecafluoro-1-octanoic acid" OR "Pentadecafluoro-n-octanoic acid" OR "Pentadecafluorooctanoic acid" OR "Pentyl perfluorobutanoate" OR "Perfluoro-n-decanoic acid" OR "Perfluoro-n-heptanoic acid" OR "Perfluoro-n-nonanoic acid" OR "Perfluoro-n-undecanoic acid" OR "Perfluorobutane sulfonic acid" OR "Perfluorobutanefluorobutanesulfonic acid" OR "Perfluorobutanoic acid" OR "Perfluorobutyric acid" OR "Perfluorocaproic acid" OR "Perfluorooctanoic acid" OR "Perfluorooctylsulfonamide" OR "Perfluorodecanoic acid" OR "Perfluorododecanoic acid" OR "Perfluorododecanoic acid" OR "Perfluoroheptanecarboxylic acid" OR "Perfluoroheptanoic acid" OR "Perfluorohexane sulfonic acid" OR "Perfluorohexane-1-sulphonic acid" OR "perfluorohexanesulfonate" OR "perfluorohexanesulfonic acid" OR "Perfluorolauric acid" OR "Perfluorononan-1-oic acid" OR "Perfluorononanoic acid" OR "Perfluorooctane sulfonamide" OR "Perfluorooctane sulfonate" OR "Perfluorooctane sulfonic acid" OR "perfluorooctane sulfonic acid" OR "Perfluorooctanesulfonamide" OR "Perfluorooctanesulfonate" OR "Perfluorooctanesulfonic acid amide" OR "perfluorooctanesulfonic acid" OR "Perfluorooctanoic acid" OR "Perfluorooctylsulfonic acid" OR "Perfluoropropanecarboxylic acid" OR "Perfluoroundecanoic acid" OR "pfbus" OR "PFDA" OR "pfdea" OR "pfdoa" OR "Pfhpa" OR "PFHS cpd" OR "pfhxs" OR "pfna" OR "PFOA" OR "PFOS" OR "pfsoa" OR "Pfua" OR "Tricosafuorododecanoic acid" OR "Tridecafluoro-1-heptanoic acid" OR "Tridecafluoroheptanoic acid") AND (ANEUPL [org] OR BIOSIS [org] OR CIS [org] OR DART [org] OR EMIC [org] OR EPIDEM [org] OR HEEP [org] OR HMTC [org] OR IPA [org] OR RISKLINE [org] OR MTGABS [org] OR NIOSH [org] OR NTIS [org] OR PESTAB [org] OR PPBIB [org]) OR ("1763-23-1" OR "2058-94-8" OR "2355-31-9" OR "2991-50-6" OR "307-55-1" OR "335-67-1" OR "335-76-2"

APPENDIX B

Table B-2. Database Query Strings Post Public Comment Searches

Database search date	Query string
	OR "355-46-4" OR "375-22-4" OR "375-73-5" OR "375-85-9" OR "375-95-1" OR "754-91-6") AND (ANEUPL [org] OR BIOSIS [org] OR CIS [org] OR DART [org] OR EMIC [org] OR EPIDEM [org] OR HEEP [org] OR HMTC [org] OR IPA [org] OR RISKLINE [org] OR MTGABS [org] OR NIOSH [org] OR NTIS [org] OR PESTAB [org] OR PPBIB [org]))) AND 2013:2016 [yr] ("1,1,2,2,3,3,4,4,4-Nonafluoro-1-butanefluoric acid" OR "1,1,2,2,3,3,4,4,4-Nonafluorobutane-1-sulphonic acid" OR "1,1,2,2,3,3,4,4,5,5,6,6,6-Tridecafluorohexane-1-sulfonic acid" OR "1-Perfluorobutanefluoric acid" OR "2,2,3,3,4,4,5,5,6,6,7,7,8,8,9,9,9-heptadecafluoro-Nonanoic acid" OR "2-(N-Ethyl-perfluorooctane sulfonamido) acetic acid" OR "2-(N-Methyl-perfluorooctane sulfonamido) acetic acid" OR "Glycine, N-ethyl-N-((1,1,2,2,3,3,4,4,5,5,6,6,7,7,8,8,8-heptadecafluorooctyl)sulfonyl)-") AND 2013:2016 [yr] AND (ANEUPL [org] OR BIOSIS [org] OR CIS [org] OR DART [org] OR EMIC [org] OR EPIDEM [org] OR HEEP [org] OR HMTC [org] OR IPA [org] OR RISKLINE [org] OR MTGABS [org] OR NIOSH [org] OR NTIS [org] OR PESTAB [org] OR PPBIB [org])
09/18/2013	("perfluorooctanoic acid" OR "pentadecafluoro 1 octanoic acid" OR "pentadecafluoro n octanoic acid" OR "pentadecafluorooctanoic acid" OR "perfluorocaprylic acid" OR "perfluorooctanoic acid" OR "perfluoroheptanecarboxylic acid" OR "perfluorooctanoic acid" OR "pentadecafluorooctanoic acid" OR "perfluorooctanoic acid" OR "perfluorooctane sulfonic acid " OR "heptadecafluoro 1 octanesulfonic acid" OR "heptadecafluoro 1 octane sulfonic acid" OR "heptadecafluorooctane 1 sulphonic acid" OR "heptadecafluorooctane sulfonic acid" OR "perfluorooctane sulfonate" OR "perfluorooctylsulfonic acid" OR "perfluorooctane sulphonic acid" OR "perfluorooctanesulfonic acid" OR "perfluorooctanesulfonate" OR "heptadecafluorooctane 1 sulphonic acid" OR "perfluorooctanesulfonic acid" OR "perfluorohexane sulfonic acid pfhxs " OR "perfluorohexanesulfonic acid" OR "perfluorohexanesulfonate" OR "perfluorohexane 1 sulphonic acid" OR "pfhs cpd" OR "2 (n ethyl perfluorooctane sulfonamido) acetic acid" OR "et pfoa acoh" OR "n ethyl n ((heptadecafluorooctyl) sulphonyl) glycine" OR "2 (n methyl perfluorooctane sulfonamido) acetic acid" OR "me pfoa acoh" OR "perfluorodecanoic acid" OR "nonadecafluoro n decanoic acid" OR "nonadecafluorodecanoic acid" OR "perfluoro n decanoic acid" OR "perfluoro n decanoic acid" OR "perfluorodecanoic acid" OR "nonadecafluorodecanoic acid" OR "perfluoro n decanoic acid" OR "perfluorobutane sulfonic acid" OR "perfluorobutanefluoric acid" OR OR "pentyl perfluorobutanoate" OR "nonafluoro 1 butanesulfonic acid" OR "perfluoroheptanoic acid" OR "tridecafluoro 1 heptanoic acid" OR "perfluoro n heptanoic acid" OR "perfluoroheptanoic acid" OR "tridecafluoroheptanoic acid" OR "perfluorononanoic acid" OR "perfluoro n nonanoic acid" OR "perfluorononan 1 oic acid" OR "perfluorooctane sulfonamide" OR "perfluorooctanesulfonamide" OR "perfluorooctylsulfonamide" OR "perfluorooctanesulfonic acid amide" OR "heptadecafluorooctanesulphonamide" OR "perfluoroundecanoic acid" OR "perfluoro n undecanoic acid" OR "hennone) AND 2007:2013 [yr] AND (ANEUPL [org] OR BIOSIS [org] OR CIS [org] OR NIH RePORTER [org] OR DART [org] OR EMIC [org] OR EPIDEM [org] OR FEDRIP [org] OR HEEP [org] OR HMTC [org] OR IPA [org] OR RISKLINE [org] OR MTGABS [org] OR NIOSH [org] OR NTIS [org] OR PESTAB [org] OR PPBIB [org]) NOT PubMed [org] NOT pubdart [org]

Table B-3. Strategies to Augment the Literature Search

Source	Query and number screened when available
TSCATS^a 5/23/2016 9/18/2013	Compounds searched: 335-67-1; 1763-23-1; 355-46-4; 2991-50-6; 2355-31-9; 335-76-2; 375-73-5; 375-85-9; 375-95-1; 754-91-6; 2058-94-8; 307-55-1; 375-22-4
NTP 5/23/2016	"335-67-1" OR "1763-23-1" OR "355-46-4" OR "2991-50-6" OR "2355-31-9" OR "335-76-2" OR "375-73-5" OR "375-85-9" OR "375-95-1" OR "754-91-6" OR "2058-94-8" OR "307-55-1" OR "375-22-4" OR "Perfluorooctanoic acid" OR "PFOA" OR "Pentadecafluoro-1-octanoic acid" OR "Pentadecafluorooctanoic acid" OR "Perfluorooctanoic acid" OR "Perfluorooctane sulfonic acid" OR "Heptadecafluorooctane-1-sulphonic acid" OR "PFOS" OR "Perfluorooctane sulfonate" OR

Table B-3. Strategies to Augment the Literature Search

Source	Query and number screened when available
	<p>"Perfluorooctylsulfonic acid" OR "perfluorooctane sulphonic acid" OR "perfluorooctanesulfonic acid" OR "Perfluorooctanesulfonate" OR "Heptadecafluorooctane-1-sulphonic acid" OR "1,1,2,2,3,3,4,4,5,5,6,6,6-Tridecafluorohexane-1-sulfonic acid" OR "Perfluorohexane sulfonic acid" OR "Perfluorohexane-1-sulphonic acid" OR "perfluorohexanesulfonate" OR "perfluorohexanesulfonic acid" OR "pfhxs" OR "Ndfda" OR "Nonadecafluorodecanoic acid" OR "Nonadecafluoro-n-decanoic acid" OR "Perfluorodecanoic acid" OR "Perfluoro-n-decanoic acid" OR "PFDA" OR "pfdea" OR "1-Perfluorobutanesulfonic acid" OR "Nonfluoro-1-butanefulfonic acid" OR "Perfluorobutane sulfonic acid" OR "Perfluorobutanesulfonic acid" OR "pfbus" OR "Perfluorononanoic acid" OR "pfna" OR "Perfluorooctanesulfonamide" OR "Perfluorododecanoic acid" OR "pfdoa" OR "Heptafluorobutyric acid" OR "Perfluorobutanoic acid" OR "Perfluorobutyric acid"</p> <p>Screened: 146 hits</p> <p>"1,1,2,2,3,3,4,4,4-Nonfluoro-1-butanefulfonic acid" OR "1,1,2,2,3,3,4,4,4-Nonfluorobutane-1-sulphonic acid" OR "Nonfluorobutanesulfonic acid" OR "Pentyl perfluorobutanoate" OR "Pentadecafluoro-n-octanoic acid" OR "Perfluorocaprylic acid" OR "Perfluoroheptanecarboxylic acid" OR "Heptadecafluoro-1-octanesulfonic acid" OR "heptadecafluoro-1-octane sulfonic acid" OR "heptadecafluorooctane sulfonic acid" OR "1-Perfluorooctanesulfonic acid" OR "PFHS cpd" OR "2-(N-Ethyl-perfluorooctane sulfonamido) acetic acid" OR "et-pfosa-acoh" OR "N-Ethyl-N-((heptadecafluorooctyl)sulphonyl)glycine" OR "Glycine, N-ethyl-N-((1,1,2,2,3,3,4,4,5,5,6,6,7,7,8,8,8-heptadecafluorooctyl)sulfonyl)-" OR "2-(N-Methyl-perfluorooctane sulfonamido) acetic acid" OR "me-pfosa-acoh" OR "Perfluoroheptanoic acid" OR "Perfluoro-n-heptanoic acid" OR "Pfhpaa" OR "Tridecafluoro-1-heptanoic acid" OR "Tridecafluoroheptanoic acid" OR "2,2,3,3,4,4,5,5,6,6,7,7,8,8,9,9,9-heptadecafluoro-Nonanoic acid" OR "Perfluoro-n-nonanoic acid" OR "Perfluorononan-1-oic acid" OR "Heptadecafluorooctanesulphonamide" OR "Perfluorooctylsulfonamide" OR "Perfluorooctane sulfonamide" OR "Perfluorooctanesulfonic acid amide" OR "Pfoaa" OR "C11-PFA" OR "Henicosafuoroundecanoic acid" OR "Perfluoro-n-undecanoic acid" OR "Perfluoroundecanoic acid" OR "Pfua" OR "Perfluorolauric acid" OR "Tricosafuorododecanoic acid" OR "Heptafluoro-1-butanoic acid" OR "Heptafluorobutanoic acid" OR "Perfluoropropanecarboxylic acid"</p> <p>Screened: 0 hits</p>
NIH RePORTER	
2/28/2017	<p>Text Search: "1,1,2,2,3,3,4,4,4-Nonfluoro-1-butanefulfonic acid" OR "1,1,2,2,3,3,4,4,4-Nonfluorobutane-1-sulphonic acid" OR "1,1,2,2,3,3,4,4,5,5,6,6,6-Tridecafluorohexane-1-sulfonic acid" OR "1-Perfluorobutanesulfonic acid" OR "2,2,3,3,4,4,5,5,6,6,7,7,8,8,9,9,9-heptadecafluoro-Nonanoic acid" OR "2-(N-Ethyl-perfluorooctane sulfonamido) acetic acid" OR "2-(N-Methyl-perfluorooctane sulfonamido) acetic acid" OR "C11-PFA" OR "et-pfosa-acoh" OR "Glycine, N-ethyl-N-((1,1,2,2,3,3,4,4,5,5,6,6,7,7,8,8,8-heptadecafluorooctyl)sulfonyl)-" OR "Henicosafuoroundecanoic acid" OR "heptadecafluoro-1-octane sulfonic acid" OR "Heptadecafluoro-1-octanesulfonic acid" OR "heptadecafluorooctane sulfonic acid" OR "Heptadecafluorooctane-1-sulphonic acid" OR "Heptadecafluorooctanesulphonamide" OR "Heptafluoro-1-butanoic acid" OR "Heptafluorobutanoic acid" OR "Heptafluorobutyric acid" OR "me-pfosa-acoh" OR "N-Ethyl-N-((heptadecafluorooctyl)sulphonyl)glycine" OR "Ndfda" OR "Nonadecafluoro-n-decanoic acid" OR "Nonadecafluorodecanoic acid" OR "Nonfluoro-1-butanefulfonic acid" OR "Nonfluorobutanesulfonic acid" OR "Pentadecafluoro-1-octanoic acid" OR "Pentadecafluoro-n-octanoic acid" OR "Pentadecafluorooctanoic acid" OR "Pentyl perfluorobutanoate" OR "Perfluoro-n-decanoic acid" OR "Perfluoro-n-heptanoic acid" OR "Perfluoro-n-nonanoic acid" OR "Perfluoro-n-undecanoic acid" OR "Perfluorobutane sulfonic acid" OR "Perfluorobutanesulfonic acid" OR "Perfluorobutanoic acid" OR "Perfluorobutyric acid" OR "Perfluorocaprylic acid" OR "Perfluorooctanoic acid" OR "Perfluorooctylsulfonamide" OR "Perfluorodecanoic acid" OR "Perfluorododecanoic acid" OR "Perfluorododecanoic acid" OR "Perfluoroheptanecarboxylic acid" OR "Perfluoroheptanoic acid" OR "Perfluorohexane sulfonic acid" OR "Perfluorohexane-1-sulphonic acid" OR "perfluorohexanesulfonate" OR "perfluorohexanesulfonic acid" OR "Perfluorolauric acid" OR "Perfluorononan-1-oic acid" OR "Perfluorononanoic acid" OR "Perfluorooctane sulfonamide" OR "Perfluorooctane sulfonate" OR "Perfluorooctane sulfonic acid" OR "perfluorooctane sulphonic acid" OR "Perfluorooctanesulfonamide" OR "Perfluorooctanesulfonate" OR "Perfluorooctanesulfonic acid"</p>

Table B-3. Strategies to Augment the Literature Search

Source	Query and number screened when available
	amide" OR "perfluorooctanesulfonic acid" OR "Perfluorooctanoic acid" OR "Perfluorooctylsulfonic acid" OR "Perfluoropropanecarboxylic acid" OR "Perfluoroundecanoic acid" OR "pfbus" OR "PFDA" OR "pfdea" OR "pfdoa" OR "Pfhpa" OR "PFHS cpd" OR "pfhxs" OR "pfna" OR "PFOA" OR "PFOS" OR "pfsoa" OR "Pfua" OR "Tricosafuorododecanoic acid" OR "Tridecafluoro-1-heptanoic acid" OR "Tridecafluoroheptanoic acid" (Advanced), Search in: Projects Admin IC: All, Fiscal Year: Active Projects, 2017, 2016, 2015, 2014, 2013, 2012 Screened: 80
4/7/2014	Compounds searched: 335-67-1; 1763-23-1; 355-46-4; 2991-50-6; 2355-31-9; 335-76-2; 375-73-5; 375-85-9; 375-95-1; 754-91-6; 2058-94-8; 307-55-1; 375-22-4 Screened: 82 hits
Other	Identified throughout the assessment process

^aSeveral versions of the TSCATS database were searched, as needed, by CASRN including TSCATS1 via Toxline (no date limit), TSCATS2 via <https://yosemite.epa.gov/oppts/epatscat8.nsf/ReportSearch?OpenForm> (date restricted by EPA receipt date), and TSCATS via CDAT (date restricted by 'Mail Received Date Range'), as well as google for recent TSCA submissions.

The May 2016 results were:

- Number of records identified from PubMed, TOXLINE, and TOXCENTER (after duplicate removal): 1,153
- Number of records identified from other strategies: 209
- Total number of records to undergo literature screening: 1,363

B.1.2 Literature Screening

A two-step process was used to screen the literature search to identify relevant studies on perfluoroalkyls:

- Title and abstract screen
- Full text screen

Title and Abstract Screen. Within the reference library, titles and abstracts were screened manually for relevance. Studies that were considered relevant (see Table B-1 for inclusion criteria) were moved to the second step of the literature screening process. Studies were excluded when the title and abstract clearly indicated that the study was not relevant to the toxicological profile.

- Number of titles and abstracts screened: 1,363
- Number of studies considered relevant and moved to the next step: 457

Full Text Screen. The second step in the literature screening process was a full text review of individual studies considered relevant in the title and abstract screen step. Each study was reviewed to determine whether it was relevant for inclusion in the toxicological profile.

- Number of studies undergoing full text review: 457
- Number of studies cited in the previous draft of the toxicological profile: 639
- Total number of studies cited in the profile: 968

A summary of the results of the literature search and screening is presented in Figure B-1.

Figure B-1. May 2016 Literature Search Results and Screen for Perfluoroalkyls

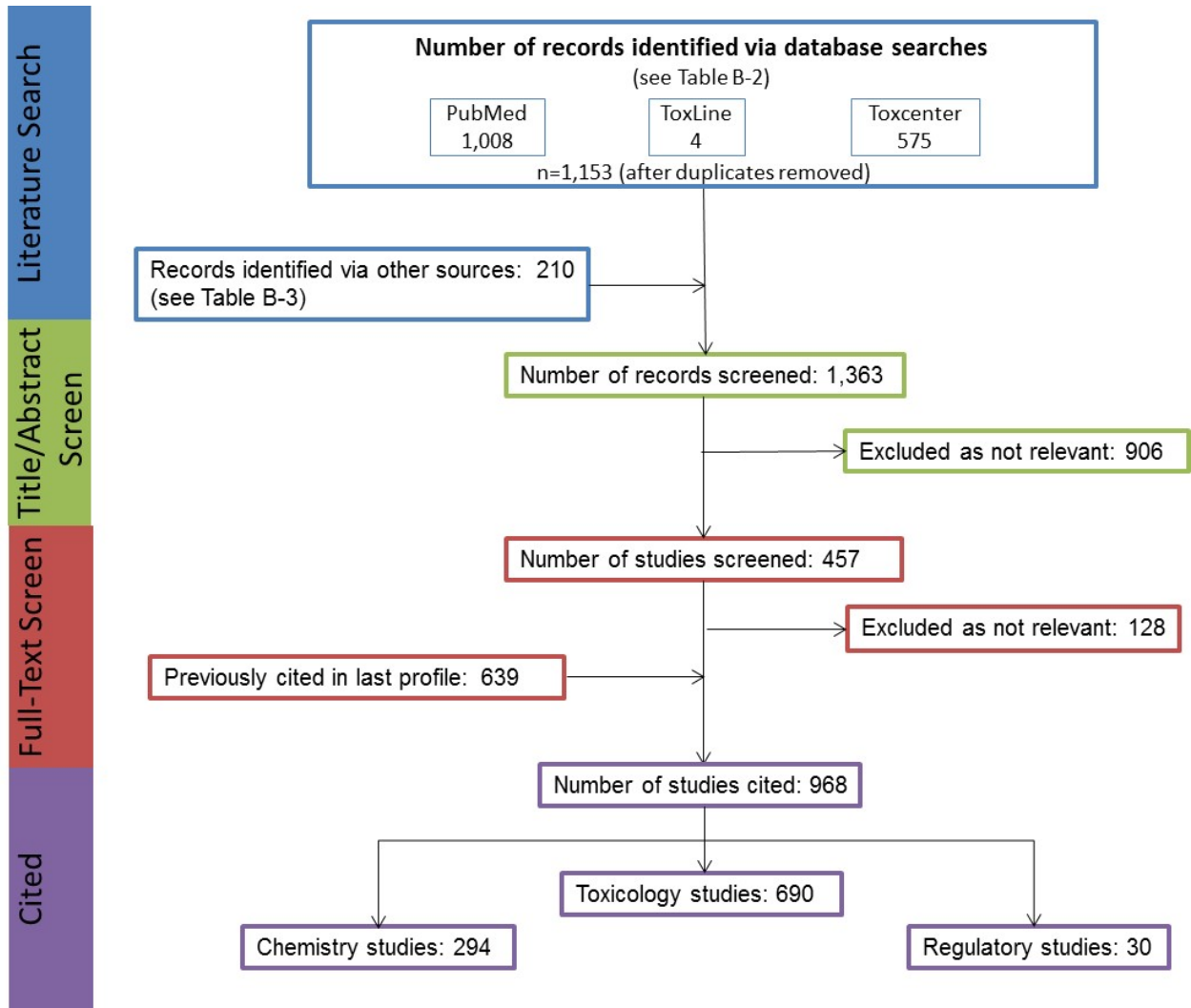

APPENDIX C. USER'S GUIDE

Chapter 1. Relevance to Public Health

This chapter provides an overview of U.S. exposures, a summary of health effects based on evaluations of existing toxicologic, epidemiologic, and toxicokinetic information, and an overview of the minimal risk levels. This is designed to present interpretive, weight-of-evidence discussions for human health endpoints by addressing the following questions:

1. What effects are known to occur in humans?
2. What effects observed in animals are likely to be of concern to humans?
3. What exposure conditions are likely to be of concern to humans, especially around hazardous waste sites?

Minimal Risk Levels (MRLs)

Where sufficient toxicologic information is available, ATSDR derives MRLs for inhalation and oral routes of entry at each duration of exposure (acute, intermediate, and chronic). These MRLs are not meant to support regulatory action, but to acquaint health professionals with exposure levels at which adverse health effects are not expected to occur in humans.

MRLs should help physicians and public health officials determine the safety of a community living near a hazardous substance emission, given the concentration of a contaminant in air or the estimated daily dose in water. MRLs are based largely on toxicological studies in animals and on reports of human occupational exposure.

MRL users should be familiar with the toxicologic information on which the number is based. Section 1.2, Summary of Health Effects, contains basic information known about the substance. Other sections, such as Section 3.2 Children and Other Populations that are Unusually Susceptible and Section 3.4 Interactions with Other Substances, provide important supplemental information.

MRL users should also understand the MRL derivation methodology. MRLs are derived using a modified version of the risk assessment methodology that the Environmental Protection Agency (EPA) provides (Barnes and Dourson 1988) to determine reference doses (RfDs) for lifetime exposure.

To derive an MRL, ATSDR generally selects the most sensitive endpoint which, in its best judgement, represents the most sensitive human health effect for a given exposure route and duration. ATSDR cannot make this judgement or derive an MRL unless information (quantitative or qualitative) is available for all potential systemic, neurological, and developmental effects. If this information and reliable quantitative data on the chosen endpoint are available, ATSDR derives an MRL using the most sensitive species (when information from multiple species is available) with the highest no-observed-adverse-effect level (NOAEL) that does not exceed any adverse effect levels. When a NOAEL is not available, a lowest-observed-adverse-effect level (LOAEL) can be used to derive an MRL, and an uncertainty factor of 10 must be employed. Additional uncertainty factors of 10 must be used both for human variability to protect sensitive subpopulations (people who are most susceptible to the health effects caused by the substance) and for interspecies variability (extrapolation from animals to humans). In deriving an MRL, these individual uncertainty factors are multiplied together. The product is then divided into the inhalation concentration or oral dosage selected from the study. Uncertainty factors used in developing a

APPENDIX C

substance-specific MRL are provided in the footnotes of the levels of significant exposure (LSE) tables that are provided in Chapter 2. Detailed discussions of the MRLs are presented in Appendix A.

Chapter 2. Health Effects

Tables and Figures for Levels of Significant Exposure (LSE)

Tables and figures are used to summarize health effects and illustrate graphically levels of exposure associated with those effects. These levels cover health effects observed at increasing dose concentrations and durations, differences in response by species and MRLs to humans for noncancer endpoints. The LSE tables and figures can be used for a quick review of the health effects and to locate data for a specific exposure scenario. The LSE tables and figures should always be used in conjunction with the text. All entries in these tables and figures represent studies that provide reliable, quantitative estimates of NOAELs, LOAELs, or Cancer Effect Levels (CELs).

The legends presented below demonstrate the application of these tables and figures. Representative examples of LSE tables and figures follow. The numbers in the left column of the legends correspond to the numbers in the example table and figure.

TABLE LEGEND

See Sample LSE Table (page C-5)

- (1) Route of exposure. One of the first considerations when reviewing the toxicity of a substance using these tables and figures should be the relevant and appropriate route of exposure. Typically, when sufficient data exist, three LSE tables and two LSE figures are presented in the document. The three LSE tables present data on the three principal routes of exposure (i.e., inhalation, oral, and dermal). LSE figures are limited to the inhalation and oral routes. Not all substances will have data on each route of exposure and will not, therefore, have all five of the tables and figures. Profiles with more than one chemical may have more LSE tables and figures.
- (2) Exposure period. Three exposure periods—acute (<15 days), intermediate (15–364 days), and chronic (≥ 365 days)—are presented within each relevant route of exposure. In this example, two oral studies of chronic-duration exposure are reported. For quick reference to health effects occurring from a known length of exposure, locate the applicable exposure period within the LSE table and figure.
- (3) Figure key. Each key number in the LSE table links study information to one or more data points using the same key number in the corresponding LSE figure. In this example, the study represented by key number 51 identified NOAELs and less serious LOAELs (also see the three "51R" data points in sample LSE Figure 2-X).
- (4) Species (strain) No./group. The test species (and strain), whether animal or human, are identified in this column. The column also contains information on the number of subjects and sex per group. Chapter 1, Relevance to Public Health, covers the relevance of animal data to human toxicity and Section 3.1, Toxicokinetics, contains any available information on comparative toxicokinetics. Although NOAELs and LOAELs are species specific, the levels are extrapolated to equivalent human doses to derive an MRL.
- (5) Exposure parameters/doses. The duration of the study and exposure regimens are provided in these columns. This permits comparison of NOAELs and LOAELs from different studies. In this case (key number 51), rats were orally exposed to "Chemical X" via feed for 2 years. For a

APPENDIX C

more complete review of the dosing regimen, refer to the appropriate sections of the text or the original reference paper (i.e., Aida et al. 1992).

- (6) Parameters monitored. This column lists the parameters used to assess health effects. Parameters monitored could include serum (blood) chemistry (BC), behavioral (BH), biochemical changes (BI), body weight (BW), clinical signs (CS), developmental toxicity (DX), enzyme activity (EA), food intake (FI), fetal toxicity (FX), gross necropsy (GN), hematology (HE), histopathology (HP), lethality (LE), maternal toxicity (MX), organ function (OF), ophthalmology (OP), organ weight (OW), teratogenicity (TG), urinalysis (UR), and water intake (WI).
- (7) Endpoint. This column lists the endpoint examined. The major categories of health endpoints included in LSE tables and figures are death, body weight, respiratory, cardiovascular, gastrointestinal, hematological, musculoskeletal, hepatic, renal, dermal, ocular, endocrine, immunological, neurological, reproductive, developmental, other noncancer, and cancer. "Other noncancer" refers to any effect (e.g., alterations in blood glucose levels) not covered in these systems. In the example of key number 51, three endpoints (body weight, hematological, and hepatic) were investigated.
- (8) NOAEL. A NOAEL is the highest exposure level at which no adverse effects were seen in the organ system studied. The body weight effect reported in key number 51 is a NOAEL at 25.5 mg/kg/day. NOAELs are not reported for cancer and death; with the exception of these two endpoints, this field is left blank if no NOAEL was identified in the study.
- (9) LOAEL. A LOAEL is the lowest dose used in the study that caused an adverse health effect. LOAELs have been classified into "Less Serious" and "Serious" effects. These distinctions help readers identify the levels of exposure at which adverse health effects first appear and the gradation of effects with increasing dose. A brief description of the specific endpoint used to quantify the adverse effect accompanies the LOAEL. Key number 51 reports a less serious LOAEL of 6.1 mg/kg/day for the hepatic system, which was used to derive a chronic exposure, oral MRL of 0.008 mg/kg/day (see footnote "c"). MRLs are not derived from serious LOAELs. A cancer effect level (CEL) is the lowest exposure level associated with the onset of carcinogenesis in experimental or epidemiologic studies. CELs are always considered serious effects. The LSE tables and figures do not contain NOAELs for cancer, but the text may report doses not causing measurable cancer increases. If no LOAEL/CEL values were identified in the study, this field is left blank.
- (10) Reference. The complete reference citation is provided in Chapter 8 of the profile.
- (11) Footnotes. Explanations of abbreviations or reference notes for data in the LSE tables are found in the footnotes. For example, footnote "c" indicates that the LOAEL of 6.1 mg/kg/day in key number 51 was used to derive an oral MRL of 0.008 mg/kg/day.

FIGURE LEGEND

See Sample LSE Figure (page C-6)

LSE figures graphically illustrate the data presented in the corresponding LSE tables. Figures help the reader quickly compare health effects according to exposure concentrations for particular exposure periods.

- (13) Exposure period. The same exposure periods appear as in the LSE table. In this example, health effects observed within the chronic exposure period are illustrated.

APPENDIX C

- (14) Endpoint. These are the categories of health effects for which reliable quantitative data exist. The same health effect endpoints appear in the LSE table.
- (15) Levels of exposure. Concentrations or doses for each health effect in the LSE tables are graphically displayed in the LSE figures. Exposure concentration or dose is measured on the log scale "y" axis. Inhalation exposure is reported in mg/m³ or ppm and oral exposure is reported in mg/kg/day.
- (16) LOAEL. In this example, the half-shaded circle that is designated 51R identifies a LOAEL critical endpoint in the rat upon which a chronic oral exposure MRL is based. The key number 51 corresponds to the entry in the LSE table. The dashed descending arrow indicates the extrapolation from the exposure level of 6.1 mg/kg/day (see entry 51 in the sample LSE table) to the MRL of 0.008 mg/kg/day (see footnote "c" in the sample LSE table).
- (17) CEL. Key number 59R is one of studies for which CELs were derived. The diamond symbol refers to a CEL for the test species (rat). The number 59 corresponds to the entry in the LSE table.
- (18) Key to LSE figure. The key provides the abbreviations and symbols used in the figure.

APPENDIX B

Table 2-X. Levels of Significant Exposure to [Chemical X] – Oral ← 1

	4 Species Figure (strain) key ^a No./group	5 Exposure parameters	6 Doses (mg/kg/day)	7 Parameters monitored	8 Endpoint	8 NOAEL (mg/kg/day)	9 Less serious LOAEL (mg/kg/day)	9 Serious LOAEL (mg/kg/day)	Effect
2	CHRONIC EXPOSURE								
3	51 ↑ Rat (Wistar) 40 M, 40 F	2 years (F)	M: 0, 6.1, 25.5, 138.0 F: 0, 8.0, 31.7, 168.4	CS, WI, BW, OW, HE, BC, HP	Bd wt Hemato Hepatic	25.5 138.0	138.0	6.1 ^c	Decreased body weight gain in males (23–25%) and females (31–39%) Increases in absolute and relative weights at ≥6.1/8.0 mg/kg/day after 12 months of exposure; fatty generation at ≥6.1 mg/kg/day in males and at ≥31.7 mg/kg/day in females, and granulomas in females at 31.7 and 168.4 mg/kg/day after 12, 18, or 24 months of exposure and in males at ≥6.1 mg/kg/day only after 24 months of exposure
10	Aida et al. 1992								
	52 Rat (F344) 78 M	104 weeks (W)	0, 3.9, 20.6, 36.3	CS, BW, FI, BC, OW, HP	Hepatic Renal Endocr.	36.3 20.6 36.3	36.3		Increased incidence of renal tubular cell hyperplasia
	George et al. 2002								
	59 Rat (Wistar) 58M, 58F	Lifetime (W)	M: 0, 90 F: 0, 190	BW, HP	Cancer		190 F		Increased incidence of hepatic neoplastic nodules in females only; no additional description of the tumors was provided
	Tumasonis et al. 1985								

11 → ^aThe number corresponds to entries in Figure 2-x.
^bUsed to derive an acute-duration oral minimal risk level (MRL) of 0.1 mg/kg/day based on the BMDL₀₅ of 10 mg/kg/day and an uncertainty factor of 100 (10 for extrapolation from animals to humans and 10 for human variability).
^cUsed to derive a chronic-duration oral MRL of 0.008 mg/kg/day based on the BMDL₁₀ of 0.78 mg/kg/day and an uncertainty factor of 100 (10 for extrapolation from animals to humans and 10 for human variability).

APPENDIX C

Figure 2-X. Levels of Significant Exposure to [Chemical X] - Oral

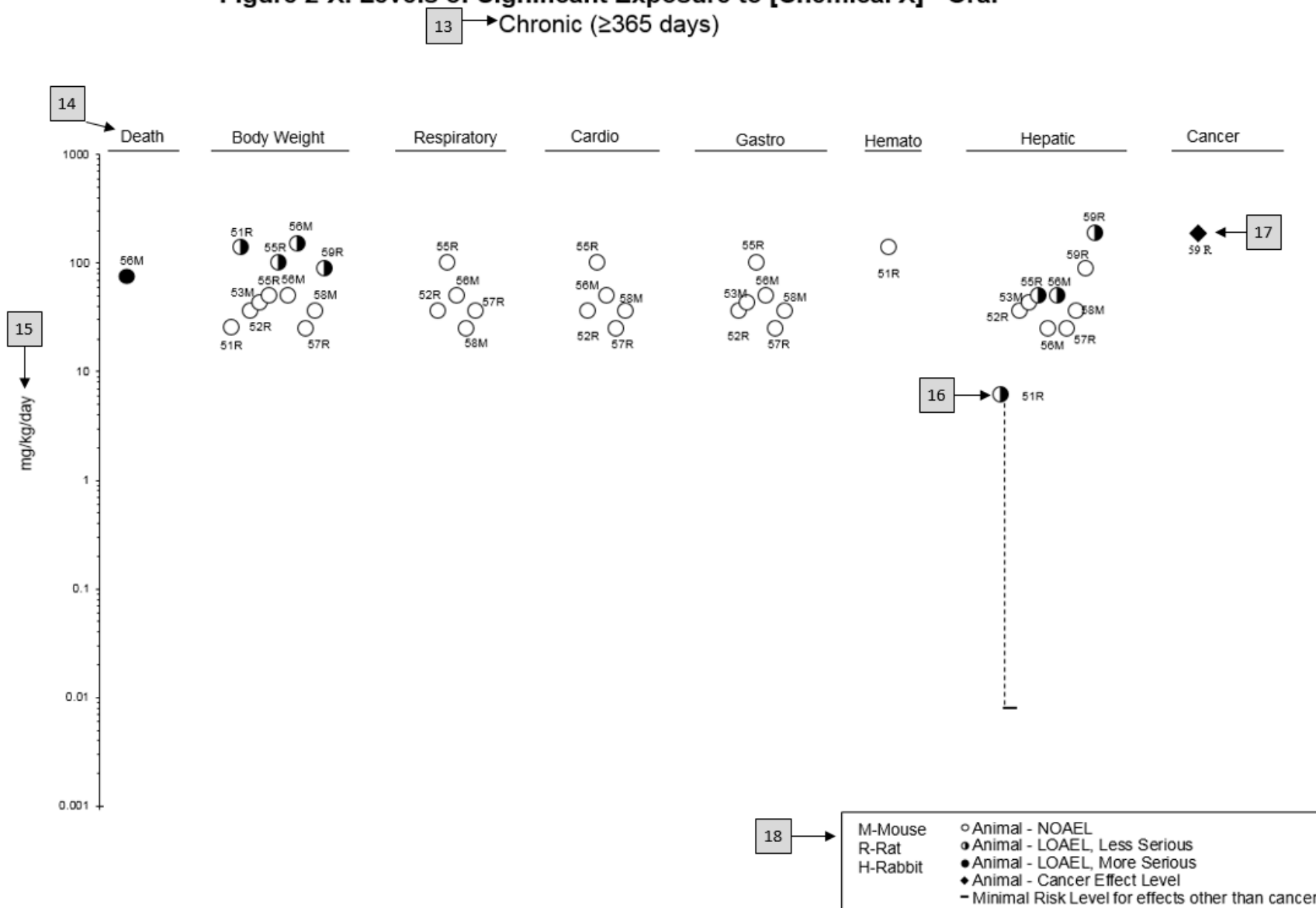

APPENDIX D. QUICK REFERENCE FOR HEALTH CARE PROVIDERS

Toxicological Profiles are a unique compilation of toxicological information on a given hazardous substance. Each profile reflects a comprehensive and extensive evaluation, summary, and interpretation of available toxicologic and epidemiologic information on a substance. Health care providers treating patients potentially exposed to hazardous substances may find the following information helpful for fast answers to often-asked questions.

Primary Chapters/Sections of Interest

Chapter 1: Relevance to Public Health: The Relevance to Public Health Section provides an overview of exposure and health effects and evaluates, interprets, and assesses the significance of toxicity data to human health. A table listing minimal risk levels (MRLs) is also included in this chapter.

Chapter 2: Health Effects: Specific health effects identified in both human and animal studies are reported by type of health effect (e.g., death, hepatic, renal, immune, reproductive), route of exposure (e.g., inhalation, oral, dermal), and length of exposure (e.g., acute, intermediate, and chronic).

NOTE: Not all health effects reported in this section are necessarily observed in the clinical setting.

Pediatrics:

Section 3.2 **Children and Other Populations that are Unusually Susceptible**
Section 3.3 **Biomarkers of Exposure and Effect**

ATSDR Information Center

Phone: 1-800-CDC-INFO (800-232-4636) or 1-888-232-6348 (TTY)

Internet: <http://www.atsdr.cdc.gov>

The following additional materials are available online:

Case Studies in Environmental Medicine are self-instructional publications designed to increase primary health care providers' knowledge of a hazardous substance in the environment and to aid in the evaluation of potentially exposed patients (see <https://www.atsdr.cdc.gov/csem/csem.html>).

Managing Hazardous Materials Incidents is a three-volume set of recommendations for on-scene (prehospital) and hospital medical management of patients exposed during a hazardous materials incident (see <https://www.atsdr.cdc.gov/MHMI/index.asp>). Volumes I and II are planning guides to assist first responders and hospital emergency department personnel in planning for incidents that involve hazardous materials. Volume III—*Medical Management Guidelines for Acute Chemical Exposures*—is a guide for health care professionals treating patients exposed to hazardous materials.

Fact Sheets (ToxFAQs™) provide answers to frequently asked questions about toxic substances (see <https://www.atsdr.cdc.gov/toxfaqs/Index.asp>).

APPENDIX D

Other Agencies and Organizations

The National Center for Environmental Health (NCEH) focuses on preventing or controlling disease, injury, and disability related to the interactions between people and their environment outside the workplace. Contact: NCEH, Mailstop F-29, 4770 Buford Highway, NE, Atlanta, GA 30341-3724 • Phone: 770-488-7000 • FAX: 770-488-7015 • Web Page: <https://www.cdc.gov/nceh/>.

The National Institute for Occupational Safety and Health (NIOSH) conducts research on occupational diseases and injuries, responds to requests for assistance by investigating problems of health and safety in the workplace, recommends standards to the Occupational Safety and Health Administration (OSHA) and the Mine Safety and Health Administration (MSHA), and trains professionals in occupational safety and health. Contact: NIOSH, 395 E Street, S.W., Suite 9200, Patriots Plaza Building, Washington, DC 20201 • Phone: 202-245-0625 or 1-800-CDC-INFO (800-232-4636) • Web Page: <https://www.cdc.gov/niosh/>.

The National Institute of Environmental Health Sciences (NIEHS) is the principal federal agency for biomedical research on the effects of chemical, physical, and biologic environmental agents on human health and well-being. Contact: NIEHS, PO Box 12233, 104 T.W. Alexander Drive, Research Triangle Park, NC 27709 • Phone: 919-541-3212 • Web Page: <https://www.niehs.nih.gov/>.

Clinical Resources (Publicly Available Information)

The Association of Occupational and Environmental Clinics (AOEC) has developed a network of clinics in the United States to provide expertise in occupational and environmental issues. Contact: AOEC, 1010 Vermont Avenue, NW, #513, Washington, DC 20005 • Phone: 202-347-4976 • FAX: 202-347-4950 • e-mail: AOEC@AOEC.ORG • Web Page: <http://www.aoec.org/>.

The American College of Occupational and Environmental Medicine (ACOEM) is an association of physicians and other health care providers specializing in the field of occupational and environmental medicine. Contact: ACOEM, 25 Northwest Point Boulevard, Suite 700, Elk Grove Village, IL 60007-1030 • Phone: 847-818-1800 • FAX: 847-818-9266 • Web Page: <http://www.acoem.org/>.

The American College of Medical Toxicology (ACMT) is a nonprofit association of physicians with recognized expertise in medical toxicology. Contact: ACMT, 10645 North Tatum Boulevard, Suite 200-111, Phoenix AZ 85028 • Phone: 844-226-8333 • FAX: 844-226-8333 • Web Page: <http://www.acmt.net>.

The Pediatric Environmental Health Specialty Units (PEHSUs) is an interconnected system of specialists who respond to questions from public health professionals, clinicians, policy makers, and the public about the impact of environmental factors on the health of children and reproductive-aged adults. Contact information for regional centers can be found at <http://pehsu.net/findhelp.html>.

The American Association of Poison Control Centers (AAPCC) provide support on the prevention and treatment of poison exposures. Contact: AAPCC, 515 King Street, Suite 510, Alexandria VA 22314 • Phone: 701-894-1858 • Poison Help Line: 1-800-222-1222 • Web Page: <http://www.aapcc.org/>.

APPENDIX E. GLOSSARY

Absorption—The process by which a substance crosses biological membranes and enters systemic circulation. Absorption can also refer to the taking up of liquids by solids, or of gases by solids or liquids.

Acute Exposure—Exposure to a chemical for a duration of ≤ 14 days, as specified in the Toxicological Profiles.

Adsorption—The adhesion in an extremely thin layer of molecules (as of gases, solutes, or liquids) to the surfaces of solid bodies or liquids with which they are in contact.

Adsorption Coefficient (K_{oc})—The ratio of the amount of a chemical adsorbed per unit weight of organic carbon in the soil or sediment to the concentration of the chemical in solution at equilibrium.

Adsorption Ratio (K_d)—The amount of a chemical adsorbed by sediment or soil (i.e., the solid phase) divided by the amount of chemical in the solution phase, which is in equilibrium with the solid phase, at a fixed solid/solution ratio. It is generally expressed in micrograms of chemical sorbed per gram of soil or sediment.

Benchmark Dose (BMD) or Benchmark Concentration (BMC)—is the dose/concentration corresponding to a specific response level estimate using a statistical dose-response model applied to either experimental toxicology or epidemiology data. For example, a BMD_{10} would be the dose corresponding to a 10% benchmark response (BMR). The BMD is determined by modeling the dose-response curve in the region of the dose-response relationship where biologically observable data are feasible. The BMDL or BMCL is the 95% lower confidence limit on the BMD or BMC.

Bioconcentration Factor (BCF)—The quotient of the concentration of a chemical in aquatic organisms at a specific time or during a discrete time period of exposure divided by the concentration in the surrounding water at the same time or during the same period.

Biomarkers—Indicators signaling events in biologic systems or samples, typically classified as markers of exposure, effect, and susceptibility.

Cancer Effect Level (CEL)—The lowest dose of a chemical in a study, or group of studies, that produces significant increases in the incidence of cancer (or tumors) between the exposed population and its appropriate control.

Carcinogen—A chemical capable of inducing cancer.

Case-Control Study—A type of epidemiological study that examines the relationship between a particular outcome (disease or condition) and a variety of potential causative agents (such as toxic chemicals). In a case-control study, a group of people with a specified and well-defined outcome is identified and compared to a similar group of people without the outcome.

Case Report—A report that describes a single individual with a particular disease or exposure. These reports may suggest some potential topics for scientific research, but are not actual research studies.

Case Series—Reports that describe the experience of a small number of individuals with the same disease or exposure. These reports may suggest potential topics for scientific research, but are not actual research studies.

APPENDIX E

Ceiling Value—A concentration that must not be exceeded.

Chronic Exposure—Exposure to a chemical for ≥ 365 days, as specified in the Toxicological Profiles.

Clastogen—A substance that causes breaks in chromosomes resulting in addition, deletion, or rearrangement of parts of the chromosome.

Cohort Study—A type of epidemiological study of a specific group or groups of people who have had a common insult (e.g., exposure to an agent suspected of causing disease or a common disease) and are followed forward from exposure to outcome, and who are disease-free at start of follow-up. Often, at least one exposed group is compared to one unexposed group, while in other cohorts, exposure is a continuous variable and analyses are directed towards analyzing an exposure-response coefficient.

Cross-sectional Study—A type of epidemiological study of a group or groups of people that examines the relationship between exposure and outcome to a chemical or to chemicals at a specific point in time.

Data Needs—Substance-specific informational needs that, if met, would reduce the uncertainties of human health risk assessment.

Developmental Toxicity—The occurrence of adverse effects on the developing organism that may result from exposure to a chemical prior to conception (either parent), during prenatal development, or postnatally to the time of sexual maturation. Adverse developmental effects may be detected at any point in the life span of the organism.

Dose-Response Relationship—The quantitative relationship between the amount of exposure to a toxicant and the incidence of the response or amount of the response.

Embryotoxicity and Fetotoxicity—Any toxic effect on the conceptus as a result of prenatal exposure to a chemical; the distinguishing feature between the two terms is the stage of development during which the effect occurs. Effects include malformations and variations, altered growth, and *in utero* death.

Epidemiology—The investigation of factors that determine the frequency and distribution of disease or other health-related conditions within a defined human population during a specified period.

Excretion—The process by which metabolic waste products are removed from the body.

Genotoxicity—A specific adverse effect on the genome of living cells that, upon the duplication of affected cells, can be expressed as a mutagenic, clastogenic, or carcinogenic event because of specific alteration of the molecular structure of the genome.

Half-life—A measure of rate for the time required to eliminate one-half of a quantity of a chemical from the body or environmental media.

Health Advisory—An estimate of acceptable drinking water levels for a chemical substance derived by EPA and based on health effects information. A health advisory is not a legally enforceable federal standard, but serves as technical guidance to assist federal, state, and local officials.

Immediately Dangerous to Life or Health (IDLH)—A condition that poses a threat of life or health, or conditions that pose an immediate threat of severe exposure to contaminants that are likely to have adverse cumulative or delayed effects on health.

APPENDIX E

Immunotoxicity—Adverse effect on the functioning of the immune system that may result from exposure to chemical substances.

Incidence—The ratio of new cases of individuals in a population who develop a specified condition to the total number of individuals in that population who could have developed that condition in a specified time period.

Intermediate Exposure—Exposure to a chemical for a duration of 15–364 days, as specified in the Toxicological Profiles.

In Vitro—Isolated from the living organism and artificially maintained, as in a test tube.

In Vivo—Occurring within the living organism.

Lethal Concentration_(LO) (LC_{LO})—The lowest concentration of a chemical in air that has been reported to have caused death in humans or animals.

Lethal Concentration₍₅₀₎ (LC₅₀)—A calculated concentration of a chemical in air to which exposure for a specific length of time is expected to cause death in 50% of a defined experimental animal population.

Lethal Dose_(LO) (LD_{LO})—The lowest dose of a chemical introduced by a route other than inhalation that has been reported to have caused death in humans or animals.

Lethal Dose₍₅₀₎ (LD₅₀)—The dose of a chemical that has been calculated to cause death in 50% of a defined experimental animal population.

Lethal Time₍₅₀₎ (LT₅₀)—A calculated period of time within which a specific concentration of a chemical is expected to cause death in 50% of a defined experimental animal population.

Lowest-Observed-Adverse-Effect Level (LOAEL)—The lowest exposure level of chemical in a study, or group of studies, that produces statistically or biologically significant increases in frequency or severity of adverse effects between the exposed population and its appropriate control.

Lymphoreticular Effects—Represent morphological effects involving lymphatic tissues such as the lymph nodes, spleen, and thymus.

Malformations—Permanent structural changes that may adversely affect survival, development, or function.

Metabolism—Process in which chemical substances are biotransformed in the body that could result in less toxic and/or readily excreted compounds or produce a biologically active intermediate.

Minimal Risk Level (MRL)—An estimate of daily human exposure to a hazardous substance that is likely to be without an appreciable risk of adverse noncancer health effects over a specified route and duration of exposure.

Modifying Factor (MF)—A value (greater than zero) that is applied to the derivation of a Minimal Risk Level (MRL) to reflect additional concerns about the database that are not covered by the uncertainty factors. The default value for a MF is 1.

APPENDIX E

Morbidity—The state of being diseased; the morbidity rate is the incidence or prevalence of a disease in a specific population.

Mortality—Death; the mortality rate is a measure of the number of deaths in a population during a specified interval of time.

Mutagen—A substance that causes mutations, which are changes in the DNA sequence of a cell's DNA. Mutations can lead to birth defects, miscarriages, or cancer.

Necropsy—The gross examination of the organs and tissues of a dead body to determine the cause of death or pathological conditions.

Neurotoxicity—The occurrence of adverse effects on the nervous system following exposure to a hazardous substance.

No-Observed-Adverse-Effect Level (NOAEL)—The dose of a chemical at which there were no statistically or biologically significant increases in frequency or severity of adverse effects seen between the exposed population and its appropriate control. Although effects may be produced at this dose, they are not considered to be adverse.

Octanol-Water Partition Coefficient (K_{ow})—The equilibrium ratio of the concentrations of a chemical in *n*-octanol and water, in dilute solution.

Odds Ratio (OR)—A means of measuring the association between an exposure (such as toxic substances and a disease or condition) that represents the best estimate of relative risk (risk as a ratio of the incidence among subjects exposed to a particular risk factor divided by the incidence among subjects who were not exposed to the risk factor). An odds ratio that is greater than 1 is considered to indicate greater risk of disease in the exposed group compared to the unexposed group.

Permissible Exposure Limit (PEL)—An Occupational Safety and Health Administration (OSHA) regulatory limit on the amount or concentration of a substance not to be exceeded in workplace air averaged over any 8-hour work shift of a 40-hour workweek.

Pesticide—General classification of chemicals specifically developed and produced for use in the control of agricultural and public health pests (insects or other organisms harmful to cultivated plants or animals).

Pharmacokinetics—The dynamic behavior of a material in the body, used to predict the fate (disposition) of an exogenous substance in an organism. Utilizing computational techniques, it provides the means of studying the absorption, distribution, metabolism, and excretion of chemicals by the body.

Pharmacokinetic Model—A set of equations that can be used to describe the time course of a parent chemical or metabolite in an animal system. There are two types of pharmacokinetic models: data-based and physiologically-based. A data-based model divides the animal system into a series of compartments, which, in general, do not represent real, identifiable anatomic regions of the body, whereas the physiologically-based model compartments represent real anatomic regions of the body.

Physiologically Based Pharmacodynamic (PBPD) Model—A type of physiologically based dose-response model that quantitatively describes the relationship between target tissue dose and toxic endpoints. These models advance the importance of physiologically based models in that they clearly describe the biological effect (response) produced by the system following exposure to an exogenous substance.

APPENDIX E

Physiologically Based Pharmacokinetic (PBPK) Model—A type of physiologically based dose-response model that is comprised of a series of compartments representing organs or tissue groups with realistic weights and blood flows. These models require a variety of physiological information, including tissue volumes, blood flow rates to tissues, cardiac output, alveolar ventilation rates, and possibly membrane permeabilities. The models also utilize biochemical information, such as blood:air partition coefficients, and metabolic parameters. PBPK models are also called biologically based tissue dosimetry models.

Prevalence—The number of cases of a disease or condition in a population at one point in time.

Prospective Study—A type of cohort study in which a group is followed over time and the pertinent observations are made on events occurring after the start of the study.

Recommended Exposure Limit (REL)—A National Institute for Occupational Safety and Health (NIOSH) time-weighted average (TWA) concentration for up to a 10-hour workday during a 40-hour workweek.

Reference Concentration (RfC)—An estimate (with uncertainty spanning perhaps an order of magnitude) of a continuous inhalation exposure to the human population (including sensitive subgroups) that is likely to be without an appreciable risk of deleterious noncancer health effects during a lifetime. The inhalation RfC is expressed in units of mg/m³ or ppm.

Reference Dose (RfD)—An estimate (with uncertainty spanning perhaps an order of magnitude) of the daily oral exposure of the human population to a potential hazard that is likely to be without risk of deleterious noncancer health effects during a lifetime. The oral RfD is expressed in units of mg/kg/day.

Reportable Quantity (RQ)—The quantity of a hazardous substance that is considered reportable under the Comprehensive Environmental Response, Compensation, and Liability Act (CERCLA). RQs are (1) ≥1 pound or (2) for selected substances, an amount established by regulation either under CERCLA or under Section 311 of the Clean Water Act. Quantities are measured over a 24-hour period.

Reproductive Toxicity—The occurrence of adverse effects on the reproductive system that may result from exposure to a hazardous substance. The toxicity may be directed to the reproductive organs and/or the related endocrine system. The manifestation of such toxicity may be noted as alterations in sexual behavior, fertility, pregnancy outcomes, or modifications in other functions that are dependent on the integrity of this system.

Retrospective Study—A type of cohort study based on a group of persons known to have been exposed at some time in the past. Data are collected from routinely recorded events, up to the time the study is undertaken. Retrospective studies are limited to causal factors that can be ascertained from existing records and/or examining survivors of the cohort.

Risk—The possibility or chance that some adverse effect will result from a given exposure to a hazardous substance.

Risk Factor—An aspect of personal behavior or lifestyle, an environmental exposure, existing health condition, or an inborn or inherited characteristic that is associated with an increased occurrence of disease or other health-related event or condition.

APPENDIX E

Risk Ratio/Relative Risk—The ratio of the risk among persons with specific risk factors compared to the risk among persons without risk factors. A risk ratio that is greater than 1 indicates greater risk of disease in the exposed group compared to the unexposed group.

Short-Term Exposure Limit (STEL)—A STEL is a 15-minute TWA exposure that should not be exceeded at any time during a workday.

Standardized Mortality Ratio (SMR)—A ratio of the observed number of deaths and the expected number of deaths in a specific standard population.

Target Organ Toxicity—This term covers a broad range of adverse effects on target organs or physiological systems (e.g., renal, cardiovascular) extending from those arising through a single limited exposure to those assumed over a lifetime of exposure to a chemical.

Teratogen—A chemical that causes structural defects that affect the development of an organism.

Threshold Limit Value (TLV)—An American Conference of Governmental Industrial Hygienists (ACGIH) concentration of a substance to which it is believed that nearly all workers may be repeatedly exposed, day after day, for a working lifetime without adverse effect. The TLV may be expressed as a Time-Weighted Average (TLV-TWA), as a Short-Term Exposure Limit (TLV-STEL), or as a ceiling limit (TLV-C).

Time-Weighted Average (TWA)—An average exposure within a given time period.

Toxicokinetic—The absorption, distribution, metabolism, and elimination of toxic compounds in the living organism.

Toxics Release Inventory (TRI)—The TRI is an EPA program that tracks toxic chemical releases and pollution prevention activities reported by industrial and federal facilities.

Uncertainty Factor (UF)—A factor used in operationally deriving the Minimal Risk Level (MRL), Reference Dose (RfD), or Reference Concentration (RfC) from experimental data. UFs are intended to account for (1) the variation in sensitivity among the members of the human population, (2) the uncertainty in extrapolating animal data to the case of human, (3) the uncertainty in extrapolating from data obtained in a study that is of less than lifetime exposure, and (4) the uncertainty in using lowest-observed-adverse-effect level (LOAEL) data rather than no-observed-adverse-effect level (NOAEL) data. A default for each individual UF is 10; if complete certainty in data exists, a value of 1 can be used; however, a reduced UF of 3 may be used on a case-by-case basis (3 being the approximate logarithmic average of 10 and 1).

Xenobiotic—Any substance that is foreign to the biological system.

APPENDIX F. ACRONYMS, ABBREVIATIONS, AND SYMBOLS

AAPCC	American Association of Poison Control Centers
ACGIH	American Conference of Governmental Industrial Hygienists
ACOEM	American College of Occupational and Environmental Medicine
ACMT	American College of Medical Toxicology
ADI	acceptable daily intake
ADME	absorption, distribution, metabolism, and excretion
AEGL	Acute Exposure Guideline Level
AIC	Akaike's information criterion
AIHA	American Industrial Hygiene Association
ALT	alanine aminotransferase
AOEC	Association of Occupational and Environmental Clinics
AP	alkaline phosphatase
APFO	ammonium perfluorooctanoate
AST	aspartate aminotransferase
atm	atmosphere
ATSDR	Agency for Toxic Substances and Disease Registry
AWQC	Ambient Water Quality Criteria
BCF	bioconcentration factor
BMD/C	benchmark dose or benchmark concentration
BMD _x	dose that produces a X% change in response rate of an adverse effect
BMDL _x	95% lower confidence limit on the BMD _x
BMDS	Benchmark Dose Software
BMR	benchmark response
BUN	blood urea nitrogen
C	centigrade
CAA	Clean Air Act
CAS	Chemical Abstract Services
CDC	Centers for Disease Control and Prevention
CEL	cancer effect level
CERCLA	Comprehensive Environmental Response, Compensation, and Liability Act
CFR	Code of Federal Regulations
Ci	curie
CI	confidence interval
cm	centimeter
CPSC	Consumer Products Safety Commission
CWA	Clean Water Act
DHHS	Department of Health and Human Services
DNA	deoxyribonucleic acid
DOD	Department of Defense
DOE	Department of Energy
DWEL	drinking water exposure level
EAFUS	Everything Added to Food in the United States
ECG/EKG	electrocardiogram
EEG	electroencephalogram
EPA	Environmental Protection Agency
ERPG	emergency response planning guidelines
Et-PFOSA- AcOH	2-(N-ethyl-perfluorooctane sulfonamide) acetic acid
F	Fahrenheit

APPENDIX F

F1	first-filial generation
FDA	Food and Drug Administration
FIFRA	Federal Insecticide, Fungicide, and Rodenticide Act
FR	Federal Register
FSH	follicle stimulating hormone
g	gram
GC	gas chromatography
gd	gestational day
GGT	γ -glutamyl transferase
GRAS	generally recognized as safe
HEC	human equivalent concentration
HED	human equivalent dose
HHS	Department of Health and Human Services
HPLC	high-performance liquid chromatography
HSDB	Hazardous Substance Data Bank
IARC	International Agency for Research on Cancer
IDLH	immediately dangerous to life and health
IRIS	Integrated Risk Information System
Kd	adsorption ratio
kg	kilogram
kkg	kilokilogram; 1 kilokilogram is equivalent to 1,000 kilograms and 1 metric ton
K _{oc}	organic carbon partition coefficient
K _{ow}	octanol-water partition coefficient
L	liter
LC	liquid chromatography
LC ₅₀	lethal concentration, 50% kill
LC _{Lo}	lethal concentration, low
LD ₅₀	lethal dose, 50% kill
LD _{Lo}	lethal dose, low
LDH	lactic dehydrogenase
LH	luteinizing hormone
LOAEL	lowest-observed-adverse-effect level
LSE	Level of Significant Exposure
LT ₅₀	lethal time, 50% kill
m	meter
mCi	millicurie
MCL	maximum contaminant level
MCLG	maximum contaminant level goal
Me-PFOSA- AcOH	2-(N-methyl-perfluorooctane sulfonamide) acetic acid
MF	modifying factor
mg	milligram
mL	milliliter
mm	millimeter
mmHg	millimeters of mercury
mmol	millimole
MRL	Minimal Risk Level
MS	mass spectrometry
MSHA	Mine Safety and Health Administration
Mt	metric ton
NAAQS	National Ambient Air Quality Standard

APPENDIX F

NAS	National Academy of Science
NCEH	National Center for Environmental Health
ND	not detected
ng	nanogram
NHANES	National Health and Nutrition Examination Survey
NIEHS	National Institute of Environmental Health Sciences
NIOSH	National Institute for Occupational Safety and Health
NLM	National Library of Medicine
nm	nanometer
nmol	nanomole
NOAEL	no-observed-adverse-effect level
NPL	National Priorities List
NR	not reported
NRC	National Research Council
NS	not specified
NTP	National Toxicology Program
OR	odds ratio
OSHA	Occupational Safety and Health Administration
PAC	Protective Action Criteria
PAH	polycyclic aromatic hydrocarbon
PBPD	physiologically based pharmacodynamic
PBPK	physiologically based pharmacokinetic
PEHSU	Pediatric Environmental Health Specialty Unit
PEL	permissible exposure limit
PEL-C	permissible exposure limit-ceiling value
PFBA	perfluorobutyric acid
PFBuS	Perfluorobutane sulfonic acid
PFDeA	perfluorodecanoic acid
PFDoA	perfluorododecanoic acid
PFHpA	perfluoroheptanoic acid
PFHxA	perfluorohexanoic acid
PFHxS	perfluorohexane sulfonic acid
PFNA	perfluorononanoic acid
PFOA	perfluorooctanoic acid
PFOSA	perfluorooctane sulfonamide
PFOS	perfluorooctane sulfonic acid
PFUA	perfluoroundecanoic acid
pg	picogram
PND	postnatal day
POD	point of departure
ppb	parts per billion
ppbv	parts per billion by volume
ppm	parts per million
ppt	parts per trillion
REL	recommended exposure level/limit
REL-C	recommended exposure level-ceiling value
RfC	reference concentration
RfD	reference dose
RNA	ribonucleic acid
SARA	Superfund Amendments and Reauthorization Act
SCE	sister chromatid exchange

APPENDIX F

SD	standard deviation
SE	standard error
SGOT	serum glutamic oxaloacetic transaminase (same as aspartate aminotransferase or AST)
SGPT	serum glutamic pyruvic transaminase (same as alanine aminotransferase or ALT)
SIC	standard industrial classification
SMR	standardized mortality ratio
sRBC	sheep red blood cell
STEL	short term exposure limit
T _{1/2}	Half-life
TLV	threshold limit value
TLV-C	threshold limit value-ceiling value
TRI	Toxics Release Inventory
TSCA	Toxic Substances Control Act
TWA	time-weighted average
UF	uncertainty factor
U.S.	United States
USDA	United States Department of Agriculture
USGS	United States Geological Survey
USNRC	U.S. Nuclear Regulatory Commission
VOC	volatile organic compound
WBC	white blood cell
WHO	World Health Organization
>	greater than
≥	greater than or equal to
=	equal to
<	less than
≤	less than or equal to
%	percent
α	alpha
β	beta
γ	gamma
δ	delta
μm	micrometer
μg	microgram
q ₁ *	cancer slope factor
-	negative
+	positive
(+)	weakly positive result
(-)	weakly negative result